

Wavin Sentio

Technical Handbook | February 2023

Control system Underfloor heating & cooling



An Orbia business.

1. Contents

1.	Content	2
2.	Introduction	4
2.1.	How to use this technical handbook	5
2.2.	Overview of available components	6
2.3.	Components	7
3.	Connect	12
3.1.	Central Control Unit and Extension Units	12
3.2.	Room thermostats and sensors	12
3.3.	Accessories	16
3.4.	Wiring of the system	18
3.5.	Smart Radiator Thermostat	30
3.6.	Connecting Dehumidifier Units	32
4.	Set	34
4.1.	Commissioning	35
4.2.	Profile selection	36
4.3.	Enrolling components to the system	37
4.3.1	Outdoor temperature sharing	42
4.4.	User Interfaces	43
4.4.1.	User interface Control Unit and Extension Units	43
4.4.2.	User interface room thermostats and sensors	44
4.4.3.	User interface for the Room Thermostats and Sensors	45
4.4.4.	Standby Temperature	52
4.4.5.	Hotel mode	52
4.4.6.	Sentio Modbus RS485	53
4.4.7	Sentio Modbus TCP/IP	53
4.5.	Sentio applications	54
4.5.1.	Heating & Cooling services	53
4.5.2.	Sentio & underfloor Cooling (UFC)	55
4.5.3.	Sentio & radiators	56
4.5.4	Dummy room	57
4.6.	Sentio & heat pump	58

4.7.	Sentio & district heating	58
	4.7.1. Sentio & district heating	60
	4.7.2. Sentio & Serial supplying circuits	62
	4.8. Sentio & boiler	63
	4.9. Sentio & Humidity control	65
	4.10. Sentio & Controlled Mechanical Ventilation	67
5.	Profiles description	69
	5.1 Profiles description	69
6.	Go	121
	6.1. Using the Sentio app	121
	6.2 Auto-update functionality	122
	6.3. Maintenance	124
	6.4. Commissioning Touch screen	125
	6.5. Sentio Modbus	126
7.	Copyright & Disclaimer	127
8.	Appendix	128
	8.1. Frequently asked questions	128
	8.2. User manual room thermostats	132
	8.3 User manual room sensor	136
	8.4 User manual Smart Radiator Thermostat	138
	8.5. User Manual WiFi Bridge	140
	8.6. User Manual Sentio Outdoor Thermostat Sensor	142
	8.7. List of symbols (room thermostat)	144
	8.8 List of compatible valves	146
	8.9 List of room status icons (Touch screen)	147
	8.10 Wavin Sentio Modbus Manual	148
9.	Technical specifications	158
	9.1. Technical specifications Central Control Unit (CCU)	162
	9.2. Technical specifications Extension Unit A	163
	9.3. Technical specifications Extension Unit VFR	163
	9.4. Technical specifications Wireless room thermostat, Wireless room thermostat with infrared floor sensor and Wireless room sensor	164
	9.5. Technical specifications Wired room thermostat, wired room sensor	164
	9.6. Technical specifications Wireless outdoor temperature sensor	165
	9.7. Technical specifications Wired outdoor temperature sensor	165
	9.8 Technical specifications Smart Radiator Thermostat	166
	9.9. Technical specifications Actuators	166
	9.10. Technical specifications Wired floor sensor	167
	9.11. Technical specifications External Antenna (3pin)	167

2. Introduction



Congratulations with purchasing this Sentio underfloor heating and cooling control system! We wish you a convenient installation and commissioning of the system. As a help we prepared this handbook for you. Please read through this handbook before beginning any installation works or operating the controls for your own safety and the best possible result. Enjoy Sentio!

The Sentio 16-zone control system can be used with both wired and wireless room thermostats / sensors and Smart Radiator Thermostats to control the room temperature, as part of a heating and cooling system.



It is important that the content of purchased products are checked upon delivery, and that any damaged or missing items are reported immediately. Please make sure that you are permitted and competent to carry out electrical installation and/or servicing work to such kind of systems to open the control unit or make any modifications. Such in accordance with (local) regulations that might differ from country to country. This system complies with all relevant EU-laws & regulations.

2.1. How to use this technical handbook

This handbook is set up in a way that it will guide you through your installation process. Sentio is a climate control system that offers a wide range of possible combinations with heat/cold sources, room control and comfort options for mainly residential situations.

You get a general overview about the system's components and how to install and connect them followed by how to set the system and finally how to use it. All latest information regarding handbook, updates, releases, functionalities, etc. can be found on the Wavin website www.wavin.com under Sentio.

You can then choose the specific chapter reflecting your situation. This will give you further information on how to set up your system.

It is prohibited to make any changes and/or modifications not specified in this handbook. Furthermore the installer shall take care that all power supplies are locked (switched off) before starting installation/wiring works.

Sentio



2.2. Overview of available Sentio componets

Component	Art. code
Wired room thermostat	3077000
Wired room thermostat & actuator	3077024
Wireless room thermostat	3077001
Wireless room thermostat & actuator	3077025
Wired room sensor	3077002
Wired room sensor & actuator	3077027
Wireless room sensor	3077003
Wireless room sensor & actuator	3077028
Wireless room thermostat with infrared floor sensor	3077004
Wireless room thermostat with infrared floor sensor & actuator	3077026
Wallbox frame for room thermostat/-sensor	4063803
Central Control Unit, 8 channels, no cable	4063796
Central Control Unit, 8 channels, cable with F plug	4063797
Central Control Unit, 8 channels, cable with G plug	4063798
Central Control Unit, 8 channels, cable with K plug	4064446
Extension Unit for Central Control Unit, 8 channels	4063800
Extension Unit for Central Control Unit, 6 Voltage Free relays	4063801
Commissioning Touch Screen	4063802
Wired outdoor temperature sensor	4063806
Wireless outdoor temperature sensor	4063807
External antenna	4063809
Wired floor sensor	4063810
Pipe sensor, strap on	4064150
Actuator 24V NC VA50	4054937
Connection cable for PC (Windows)	4064828
Servo motor 3-pos., 24V	4064829
Servo motor 10-0V control	4030065
Sentio Outdoor Thermometer	4063808
Smart Radiator Thermostat, Wireless, RA	4063804
Smart Radiator Thermostat, Wireless. M28/30	4063804

2.3. Components

Central Control Unit, Extension Unit A, Extension Unit VFR

The Central Control Unit (CCU) is the heart and brain of the Sentio System. Easily configure the system by loading a predefined profile to control your underfloor heating/cooling system. The CCU can be used with up to 24 wired or wireless room thermostats/sensors, 16 Smart Radiator Thermostat and up to 16 thermal actuators to control up to eight different zones. Furthermore, it contains five temperature inputs, two servo outputs, two voltage free relays (230V) and two pump relays. On the bottom side of the CCU there are two ports for a connection via PC connection cable, up to 2 touch screens or up to 4 extension units (max. 2 of each type).

The CCU's possible range of applications can be enlarged by combining it with extension units to connect to eight extra outputs (EU-A) to control up to eight additional zones or up to six extra voltage free relays (EU-VFR). It is maximum possible to connect 16 actuators to a Sentio system.

The CCU must be connected to the corresponding peripherals (e.g. room thermostat) that provide the demanded information about the zones to be controlled. The heating/cooling usually is controlled via the set room temperature but also floor temperature and humidity can be used as set points.

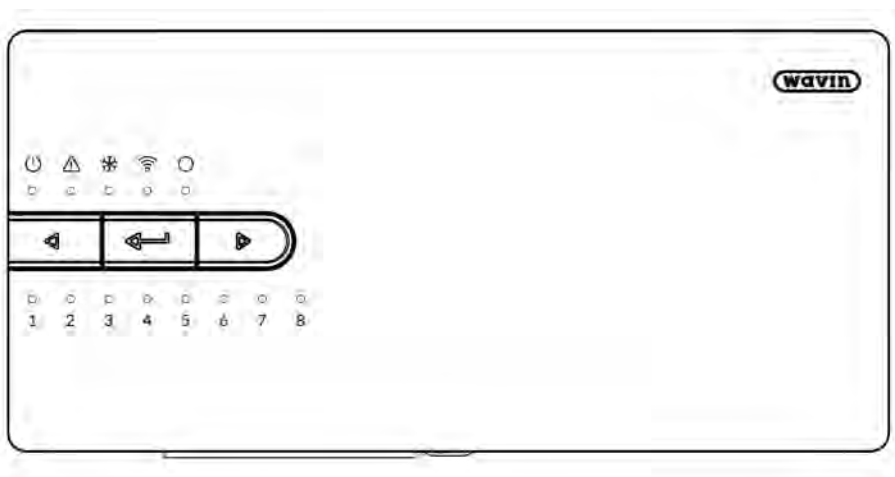

Central Control Unit.

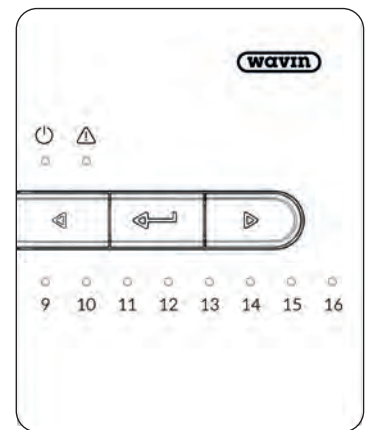

Extension Unit A.

Commissioning Touch Screen / PC



The touch screen can be used for a comfortable commissioning of the Sentio system. One touch screen can be used for several CCUs. It is not necessary for the daily use of the Sentio system to have a touch screen, although it is offering extra insights of the system behaviour. The touch screen is connected via an Ethernet cable (included in packaging) to the CCU.

Alternatively, the commissioning can be done via a Windows laptop. This is done by connecting the Sentio communication cable to the control unit. The same functionalities are available on the laptop as the touchscreen. The tool for the commissioning via laptop can be downloaded via www.wavin.com/sentio.

Outdoor Temperature Sensors

There are two different types of outdoor temperature sensors available. A wired and a wireless one. Both cover the same range of application and only differ by the way how they are connected /communicating to the CCU. When using the wired version, there is a connection available for an extra sensor for situations where the outdoor temperature drops as low as -25 °C. With the wireless outdoor sensor it is possible to connect it to multiple central control units in wireless signal range.

The outdoor temperature is used for weather compensation. In its simplest form heating will be blocked if the outside temperature has reached a certain temperature to avoid unnecessary heating. When using an Inlet Temperature Controller (ITC) the outdoor temperature is mandatory in order to heat in the most efficient way based on a weather depended heat curve.

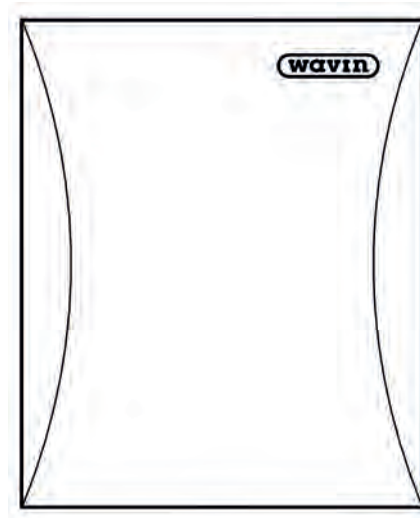

Wired/Wireless Outdoor temperature sensor.

External Antenna

The Sentio system is using radio signals to communicate. In some instances the signals can be disturbed by other radio equipments or things like big metal cabinets or similar. To avoid this disturbances it is possible to connect an external antenna to the CCU.

Room Thermostat / Sensor

Room thermostats/sensors measure the necessary data in the rooms that have to be controlled by the CCU.

The Sentio system includes both wired and wireless versions. Wired peripherals can be connected via a BUS cable to the CCU. Furthermore, a floor temperature sensor (art. 4063810) can be connected to the wired Room thermostats/sensors. The wireless room thermostat is available with an infrared sensor that measures the floor temperature.

Room thermostats/sensors measures the room temperature, the humidity and if needed the floor temperature. Via the room thermostats the room temperature can be set and the room's status is shown. Also, some settings can be changed or set by the end-user. It also has a deeper layer of settings of the installer.

Only Sentio room thermostats/sensors can be used with a Sentio central control unit. Products of other providers are not compatible.

When a wall box frame (60 mm type) is used a dedicated frame is available in order to host the room thermostat/sensor and to cover the full wall box frame. The frame is suitable for all offered room thermostats and room sensors, also for the ones with a floor sensor.

Floor Sensor

A floor sensor can be mounted to the wired room thermostats/sensors in those cases that the floor temperature shall be monitored and /or controlled in order to prevent damages to the floor due to too high temperatures. Floor sensors are available for the Sentio system.

Smart Radiator Thermostat

The Smart Radiator Thermostat is a wireless motorized radiator thermostat that controls the opening stroke of the hydraulic valve mounted on each radiator. It regulates the temperature in a single room directly on the radiator or it is supportive to the underfloor heating system when present. By doing this it contributes to an improved comfort in the room and will optimize energy consumption.

The Smart Radiator Thermostat can be used in different setups. It can be used in combination with a Sentio room thermostat/sensor, but it can also be used without.

To make use of The Smart Radiator Thermostat it always must be enrolled to the Sentio Central Control Unit. In total 16 Smart Radiator Thermostats can be enrolled.

BUS connection

Sentio's wired peripherals (room thermostats/sensors, extension units and outdoor temperature sensor) can be connected using a RS485 wired BUS connection (ROXi-BUS). The wired peripherals can be connected to the BUS in series or in parallel, as long as all respective connections of the wired peripheral end up at the +U/A/B/GN connections on the CCU and the total current on the BUS stays under 1,5 A.

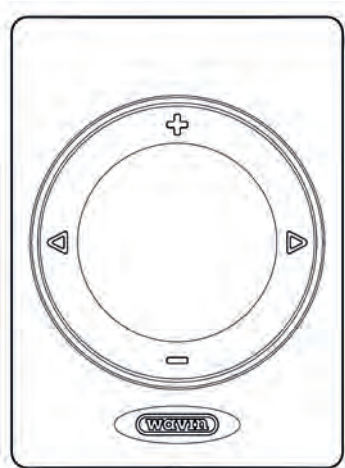

Room Thermostat.



Room Sensor.

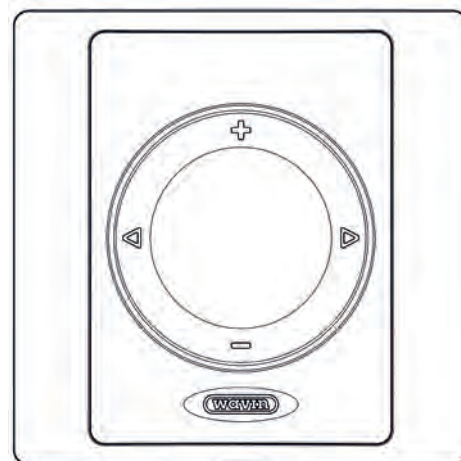

Room Thermostat in wallbox frame.

Inlet/Return Temperature Sensor

An inlet temperature sensor is used to measure the temperature of the water going into the system. It is recommended to install such a pipe sensor (art. 4064150) to the system since it measures the inlet temperature and serves as a maximal temperature protection. Without the inlet temperature sensor the system won't work.

An return temperature sensor can also be installed this depends on the profile that is being used. For certain profiles it is mandatory and for most profiles optional.

Mixing Unit and Actuators

The CCU provides connections for two circulation pumps for mixing units. The two circuits each have their own inlet and return temperature sensors to protect the underfloor system against too high inlet temperature and condensation at too low temperatures. With the ITC (Inlet Temperature Control) functionality the mixing units can be controlled in a clever way to increase efficiency.

Underfloor loops are controlled via thermal actuators on the manifold. Wavin's 24V NC actuators are built with an first open function that allows the thermal actuators to be installed easily, after starting the system the actuators will fully open the first time they are connected to break the first open function and proceed to normal behavior.

In total 16 actuators can be connected to the CCU, two pieces per output, or split between the CCU and the extension unit (EU-A). The extension unit can only have one actuator per output.

Disposables



The Sentio System is an electronic product and thus cannot be disposed with other types of waste at the end of its lifespan, indicated with the 'crossed out wheelerbin'. Please keep them separate from other waste and contact your installer, electronics store or local government for a electronic collection point near you and avoid harmful substances from being released into nature.

Empty batteries will have to be switched out, kept separate from other waste and handed in at a battery disposal point, often this can be found at places where batteries are sold.

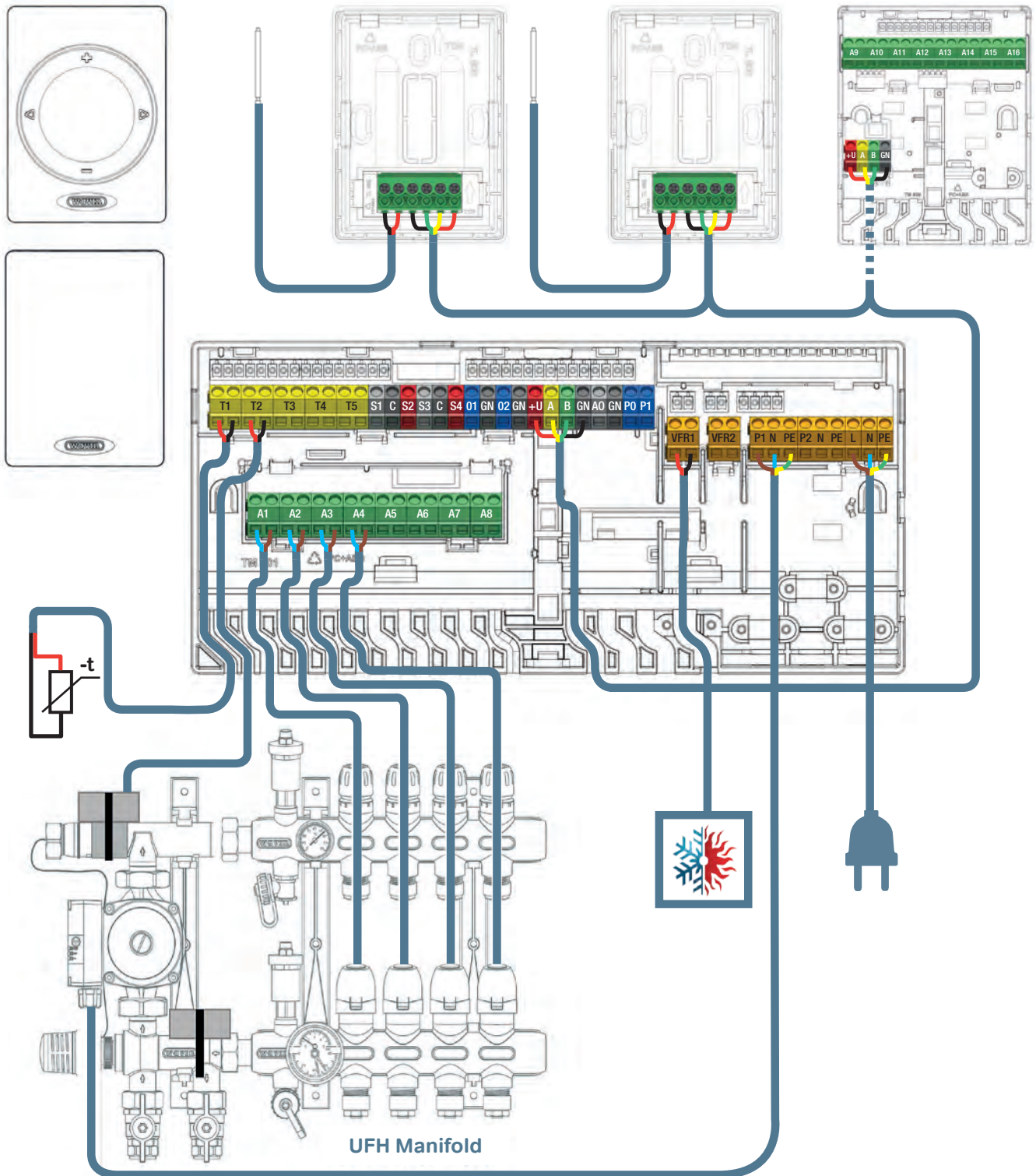

Terminal cable set-up.

3. Connect

General

Considerations where to place the CCU including that EUs can be installed in different ways at different locations. All components must be installed and grounded in compliance with the local regulations.

The Sentio system can contain a fixed maximum number of components. Keep these in mind when designing a system

Rooms	24
Thermo Actuators 24V DC 1W	16
Dehumidifiers	4
Room Thermostats/Sensors	24
Outdoor Temperature Sensor	1
Smart Radiator Thermostat	16
Extension Unit (EU-A)	2
Extension Unit with VFR (EU-VFR)	2
Touch Screen Commissioning tool	2

3.1. Central Control Unit and Extension Units

Mounting of the Central Control Unit and Extension Units

Identify a suitable location to mount the Central Control Unit (CCU) or Extension Unit (EU). It should be mounted:

- In a dry, indoor environment with a relative humidity of no more than 85%.
- Where it will not be exposed to temperatures less than 0°C or higher than 40°C.
- Not inside metal cabinet, as this will harm wireless communication.
- Above the manifold, within cable reach of the valve actuators and the pump.
- The CCU can be mounted to the wall using its integrated spirit leveller.
- Alternatively, CCU and EUs can be mounted on a 35 mm DIN Rail.

A 230V AC 50Hz power supply is needed for the CCU and has to be available. When the Sentio app is used the CCU needs to be connected to the internet via a LAN cable. When EUs are used, and the items will not be mounted on a DIN-rail connect them with the attached connection elements. The connecting element ensures a firm connection while maintaining a predefined distance between the base plates of CCU and EUs.

Open/Close Central Control Unit and Extension Units

To mount CCU and EUs they must be opened first. They are secured against opening by itself by a locking pin. Use a screw driver to pull the locking-pin down. You will hear a “click”. Upon delivery the CCUs and the EUs are not fully closed and can be opened easily.

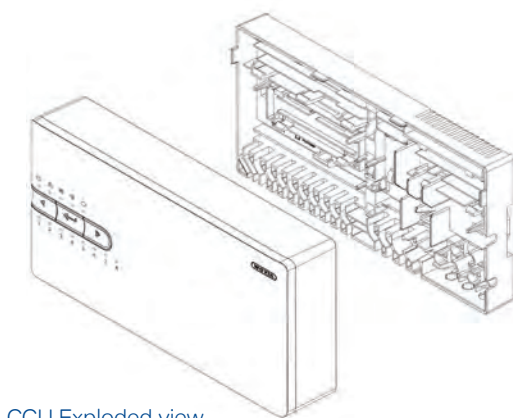

CCU Exploded view.

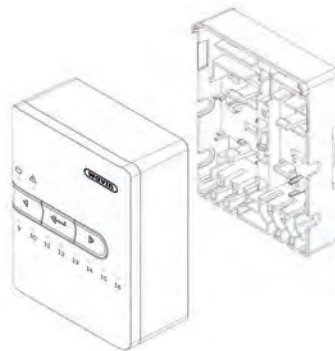

EU-A Exploded view.

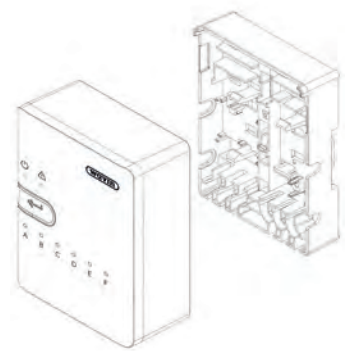

EU-VFR Exploded view.

You can open the unit by moving the front panel upwards (unit laying in front of you) or ahead (mounted on the wall). To close the units later again, put the front panel on again. Push firmly on the locking-pin by hand until you hear a clear a “click” again.

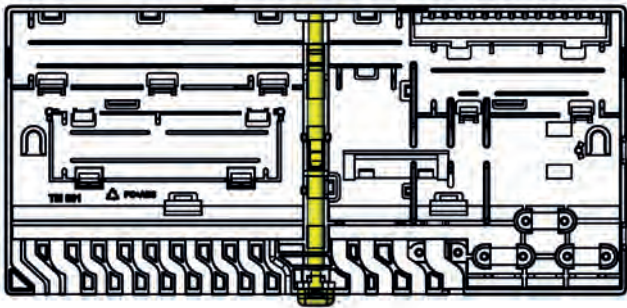

CCU back plate incl. locking-pin.

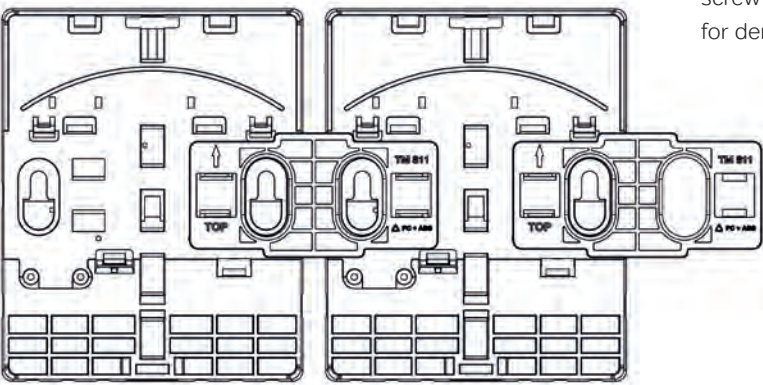

EUs connected with connection element.

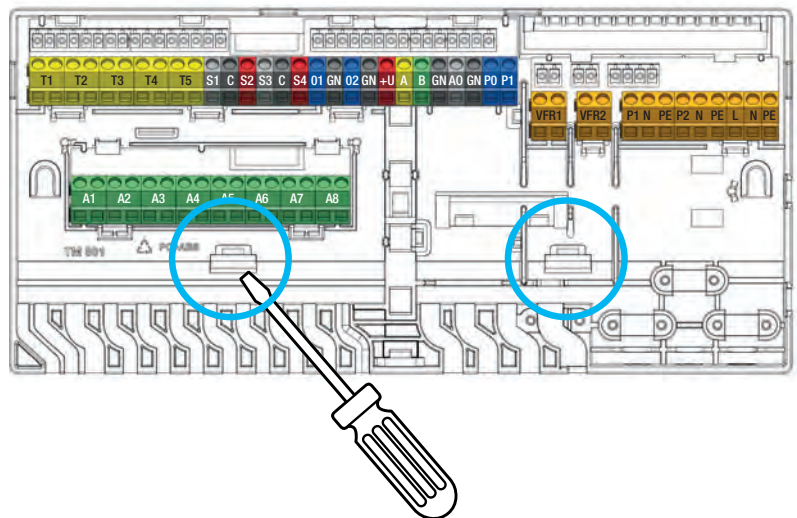

Demounting CCU and EUs from a DIN rail.

Mounting CCU and EUs on the wall

The CCU can be mounted directly on a wall and comes provided with built-in spirit level, screws and dowels. Alternatively, the CCU can be mounted on a 35 mm DIN-rail.

To ensure a proper wall mounting the spirit leveler, integrated to the CCU, can be used. Connect the EUs with the connection elements to ease the installation and to ensure a firm and stable positioning.

Mounting / Demounting CCU and EUs on a DIN-rail

The units' base parts are suitable to be mounted on a 35 mm DIN-rail (type O, EN 50022). They can be clicked on a mounted DIN-rail can be inserted in from the side. The connection elements shall not be used when the units are mounted on a DIN-rail.

The CCU has two and the EUs have one lock for the DIN-rail. A screw driver can be used to unlock and release the units again for demounting from the DIN-rail.

Wall mounted



Open



Replace batteries

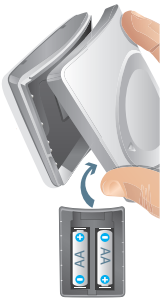

Close



3.2. Room thermostats/sensors

Opening/Closing room thermostats/sensors

Upon delivery the room thermostats/sensors are not fully closed and can be opened easily. Follow the below described procedure for installation to a wall.



Do not use any tools for opening as this will damage the products.

Identifying a suitable location

Identifying a suitable location to mount the room thermostats requires careful planning. It is critical to achieve energy efficient control of the heating system. It is recommended that you discuss it with the property owner or specifier to understand their preferences.

Generally, room thermostats/sensors should be mounted:

- ⦿ In a dry, indoor location
- ⦿ Approximately 1.2 m to 1.5 m above the floor level
- ⦿ In an area with good air circulation
- ⦿ Away from:
 - Draughts caused by adjoining rooms or windows
 - Dead air spots such as those behind a door
 - Radiant heat such as direct sunlight
 - Convection heat from a heat emitter (e.g. radiator)
- ⦿ Avoid mounting wireless room thermostats/sensors directly on or against metal surfaces or bases which may disturb radio communication

The floor sensor is normally positioned about 1.5 m from the wall and directly aligned to the room thermostat/sensor. The floor sensor must be installed between 2 pipes.

Also consider placement of room thermostats with infrared floor sensor, since these use the area below the room thermostat as reference for floor temperature. A clear sight from the room thermostat to the floor is required.

Mounting wireless room thermostats/sensors without a frame

- 1) Open the room thermostat/sensor to mount the back plate on the wall
- 2) Check the “TOP” indication and use the supplied screws. Ensure that the wall is flat. Always use at least two screws to ensure a firm mounting of the back plate. These two screws shall be opposite each other.
- 3) Now the base plate of the room thermostats/sensors is ready to mount the top part. One of the options to enrol a wireless room thermostats/sensors to the CCU/EU is to add batteries after having chosen the enrolment function at the CCU (please see in the chapter “enrolling”). When you want to use this, please do not close the room thermostat/sensor. Otherwise add two A++ batteries to the top-part of the room thermostat/sensor and consider their correct direction. Then position the top end of the front plate on the back plate (TOP to TOP, signed by arrows on both plates). Once the top is positioned, the front plate can be connected to the back plate by pushing on the Wavin logo till a ‘click’ is heard.

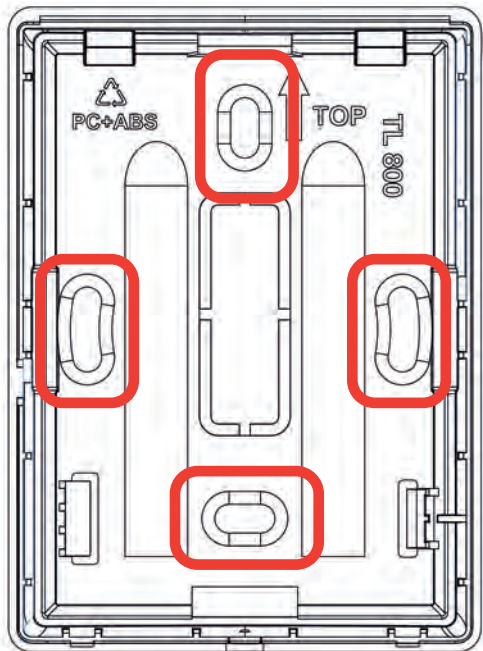

Back plate room thermostat/sensor.

Mounting wired room thermostats/sensors without a frame

- 1) Open the room thermostat and remove the foreseen space for the cable at the predetermined breaking points.

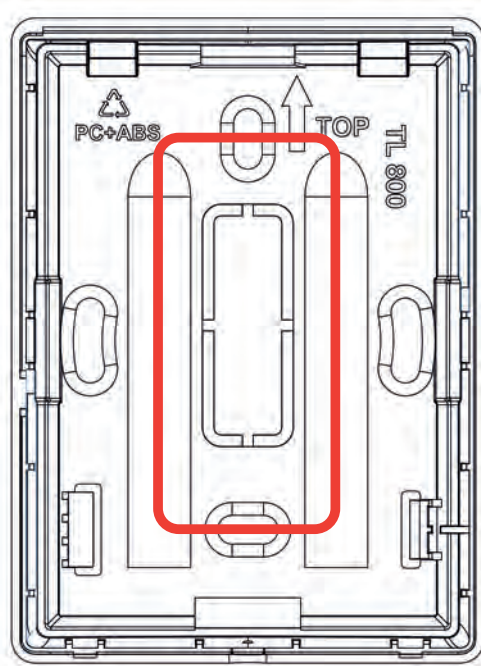

Back plate room thermostats/sensors.

- 2) Check the “TOP” indication and use the supplied screws. Ensure that the wall is flat enough. Always use at least two screws to ensure a firm mounting of the back plate. These two screws shall be opposite each other's. The BUS cable must be guided through the foreseen hole.
- 3) Connect the BUS cable to terminal block, please see instruction in paragraph 3.4.
- 4) Now the base plate of the room thermostat/sensor is ready to mount the top part. Position the top end of the front plate on the back plate (TOP to TOP, signed by arrows on both plates). Once the top is positioned, the front plate can be connected to the back plate by pushing on the Wavin logo till a ‘click’ is heard.

Mounting room thermostats/sensors when wall-box is used

When using a wall box frame, the frame's base plate must be mounted on the wall box (60 mm) and the room thermostats/sensors later will be clicked in.

- 1) Open the frame to mount the back plate on the wall. If the frame is used for a wired room thermostats/sensors, remove the foreseen space for the cable at the predetermined breaking points.
- 2) Check the "TOP" indication and use the supplied screws. Ensure that the wall box is mounted correctly. Always use two screws to ensure a firm mounting of the back plate. These two screws shall be opposite each other. The BUS cable must be guided through the foreseen holes.

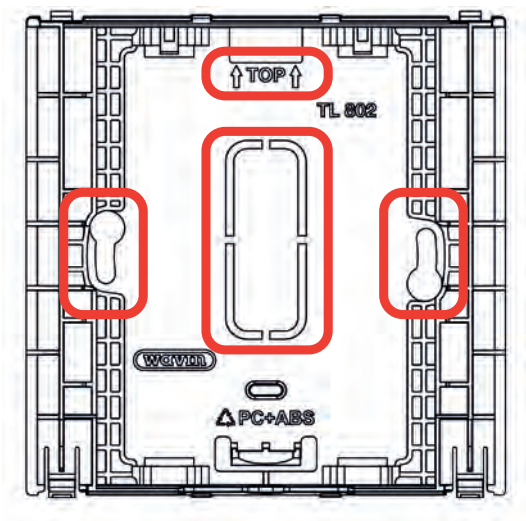

Back plate wall-box frame.

- 3) Now the base plate is mounted, and the room thermostats/sensors can be added. Wireless ones can be pushed in upright and the snap will connect frame and room thermostats/sensors.

When a wired room thermostat/sensor is used first the foreseen space for the cable must be removed from the room thermostat/sensor backplate at the predetermined breaking points and the BUS cable must be guided through the foreseen hole. Then the room thermostat/sensor can be pushed in upright, too, and the snap will connect frame and room thermostat/sensor.

3.3. Accessories

Mounting the External Antenna



The external antenna, when used, shall be installed close to the CCU taking the connected cable length into consideration in order to improve the radio signal strength. Determine the best possible location in order to ensure the most powerful signal and avoid for example thick walls and steel constructions.

Mounting the Outdoor Temperature Sensor

The outdoor temperature sensor for weather compensation has influence on the heating curve (only for condensing boilers and ITC regulation) shall be mounted on a north wall away from solar gain.

For systems with an automatic heating/cooling switch-over an outdoor temperature sensor is mandatory. The outdoor temperature determines whether the system is heating or cooling.

Within the Sentio system a wireless and wired (BUS system) outdoor temperature is available as ad described in paragraph 2.3.

Mounting Inlet/Return Temperature Sensor

The wiring of the inlet/return sensors has to be done according this picture and the CCU Input/Output list in paragraph 3.4. Wiring of the System. The cable should be min. 2x0,5 mm².

Mounting inlet/return sensors on a mixing unit and wired connection with CCU.

The servo, needed for profiles with ITC (Inlet Temperature Control) shall be installed on the mixing unit instead of the manual valve, according to the manual of the servo.

The wiring has to be done according the CCU Input/Output list in paragraph 3.4. Wiring of the System.

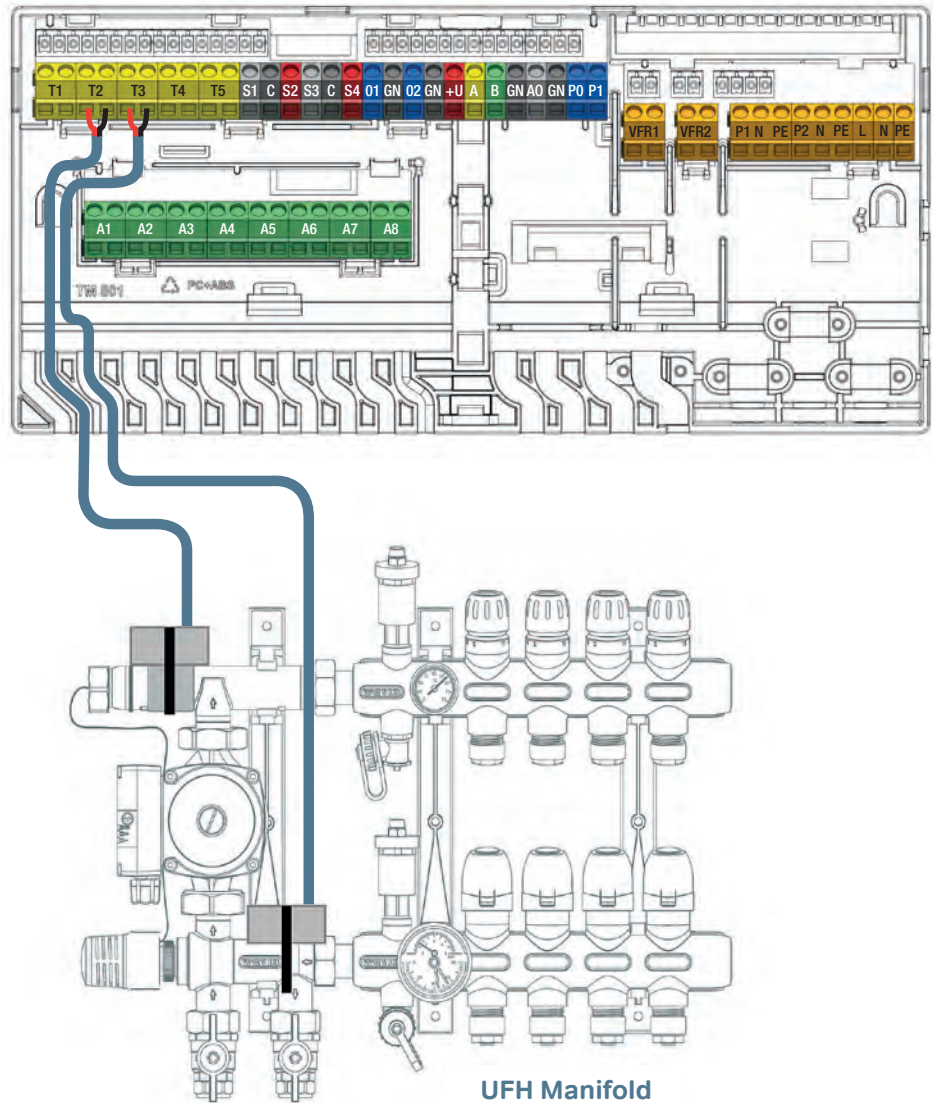

3.4. Wiring of the System



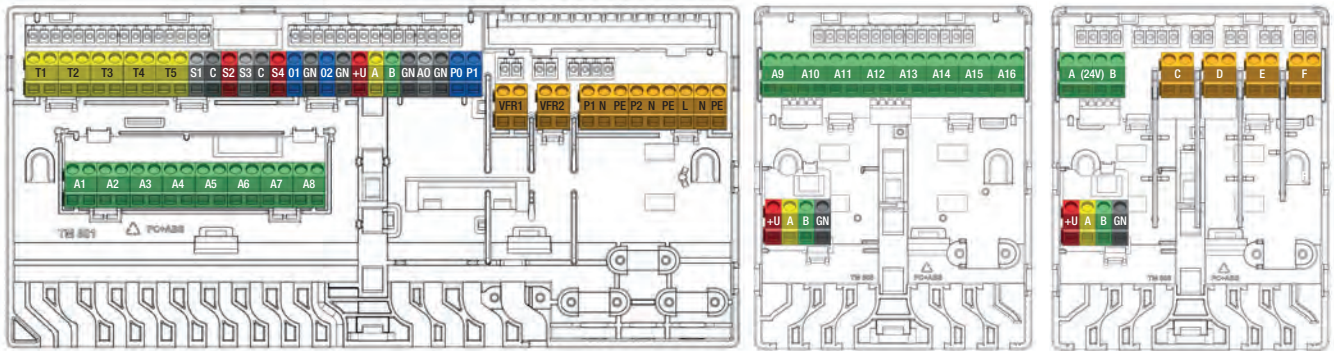









Terminals CCU and EUs







Terminals CCU and EUs.

CCU Input/Output List







Purpose	Label	Color	Description
Thermoactuator 1-8	A1-A8	Green	Electronic output intended for 1 or 2 pcs of 24V DC 1W/PC Wavin thermoactuators
Temperature sensor 1	T1	Yellow	Input for NTC-10kΩ temperature sensor, (default outdoor thermometer or source temperature sensor)
Temperature sensor 2/4	T2/T4	Yellow	Input for NTC-10kΩ temperature sensor, default inlet temperature sensor mixing units
Temperature sensor 3/5	T3/T5	Yellow	Input for NTC-10kΩ temperature sensor, default outlet temperature sensor mixing units
ITC Servo output 1 24V 2W	S1	Grey	0-10V output or S+ output for 3point for servo , maximum load 24V 2W
	C	Dark Grey	Common terminal for servo ITC1
	S2	Red	+24V for 0-10V servo or S- signal for 3point servo maximum load 24V 2W
ITC Servo output 2 24V 2W	S3	Grey	0-10V output or S+ output for 3point for servo maximum load 24V 2W
	C	Dark Grey	Common terminal for servo ITC2
	S4	Red	+24V for 0-10V servo or S- signal for 3point servo maximum load 24V 2W
General Purpose I/O1	IO1	Blue	ON/OFF universal Input / Output. Input 5V 5mA, output = O.C. 100mA
	GN	Dark Grey	Common terminal for GPIO1
General Purpose I/O2	IO2	Blue	ON/OFF universal Input / Output. Input 5V 5mA, output = O.C. 100mA
	GN	Dark Grey	Common terminal for GPIO2
ROXi BUS connection wired Sentio components	+U	Red	+ 24V for ROXi BUS, maximum output current controlled by power management
	A	Yellow	A data signal for ROXi BUS
	B	Green	B data signal for ROXi BUS
	GN	Dark Grey	Ground for ROXi BUS
Analog output 0-10V	AO	Grey	Analog output 0-10V / "+"
	GN	Dark Grey	Common terminal for AO, PO, PI / "-"

PWM - out	1	PO		PWM output 100Hz-5kHz, using common terminal GN with analogue output AO
PWM – in	1	PI		PWM input 100Hz, using common terminal GN with analogue output AO
Voltage Free Relay 1	2	VFR1		ON/OFF voltage free relay, AC 24-230V, 1A
Voltage Free Relay 2	2	VFR2		ON/OFF voltage free relay, AC 24-230V, 1A
Mixing Pump 1	3	P1		ON/OFF output for circulation pump 1, AC 230V 1A, switched to Mains L
		N		Neutral for Pump 1, connected to mains N
		PE		PE for Pump 1, connected to mains PE
Mixing Pump 2	3	P2		ON/OFF output for circulation pump2, AC 230V 1A, switched to mains L
		N		Neutral for Pump 2, connected to mains N
		PE		PE for Pump 2, connected to mains PE
Mains / Power supply	3	L		Main power input – Live (AC 230V)
		N		Main power input – Neutral
		PE		Main power input – PE

EU-A Input/Output List

Purpose	Label	Color	Description
Thermoactuator 9-16	A9-A16		Electronic output intended for one of 24V DC 1W/PC Wavin thermoactuator
ROXi BUS connection	+U		+ 24V for ROXi BUS, maximum output current 0.1A
wired Sentio components	A		A data signal for ROXi BUS
	B		B data signal for ROXi BUS
	GN		Ground for ROXi BUS

EU-VFR Input/Output List

Purpose	Label	Color	Description
VFR relay A/B	A/B		Voltage free relay output, DC/AC 24V, 1A each, Intended for similar voltage loads, cannot be combined High and Low voltage.
VFR relay C-F	C-F		Voltage free relay output, AC 24-230V, 1A each,
ROXi BUS connection	+U		+ 24V for ROXi BUS, maximum output current 0.1A
wired Sentio components	A		A data signal for ROXi BUS
	B		B data signal for ROXi BUS
	GN		Ground for ROXi BUS

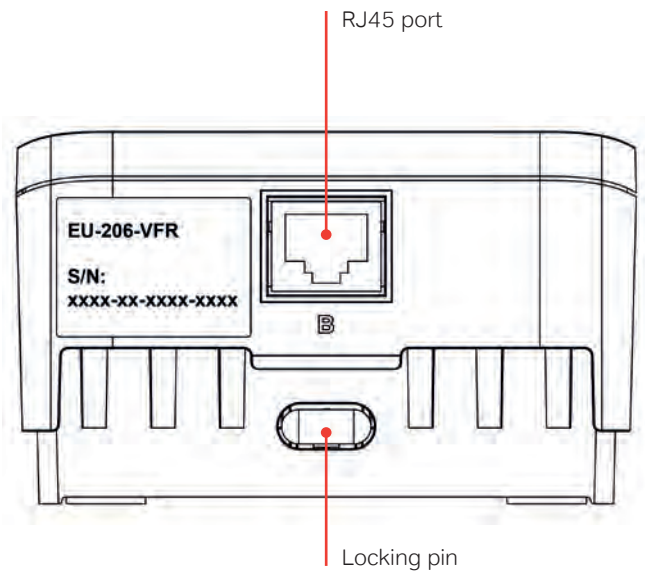
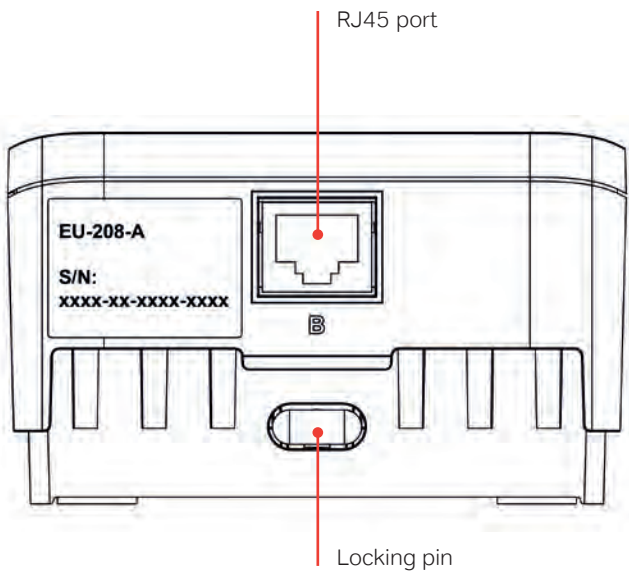
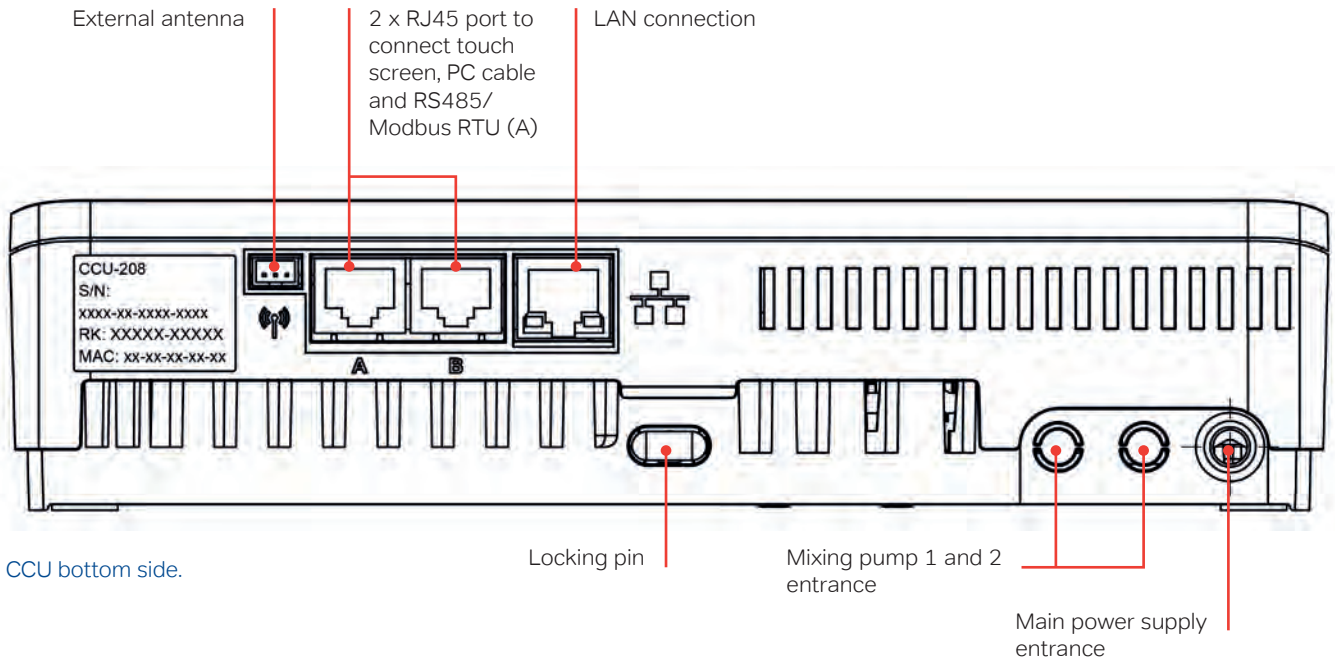

EUs bottom side.

Terminals Wired Thermostat/Sensor

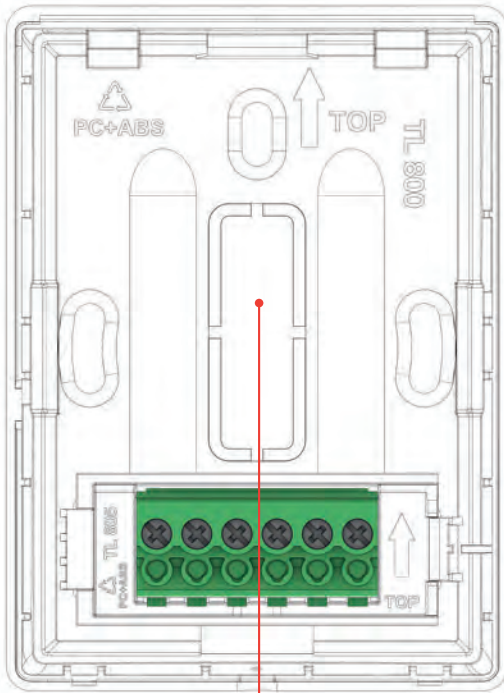

Removable part

Terminal block description

1	External temperature sensor
2	External temperature sensor
3	GND (BUS Roxi)
4	B channel (BUS Roxi)
5	A channel (BUS Roxi)
6	+U (BUS Roxi)

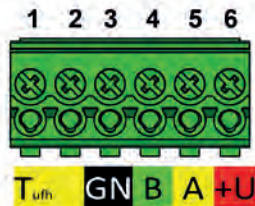

Terminals wired room thermostat/sensor.

Connecting Components

Connecting CCU and EUs

There are three different ways how to do the physical connection of the CCU and the EUs. The preferred way is the internal connection via the interconnection cables provided with the CCU/EUs. But in those cases, in which two mixing units are installed the EU can be located next to the 2nd mixing unit and connected to the CCU via UTP/RJ45 cable.

The following interconnections are possible:

- ⓘ **Local internal:** Internal cable (supplied with the EU) inserted to internal connectors (all internal connectors have the same function, see picture).
- ⓘ **Local external:** Ethernet patch cable with 4 twisted pairs (UTP) with wires AWG24 max. 97miliOhms/m inserted to external RJ connectors signed "B". Cable length significantly depends on number connected thermostats - see table below.
- ⓘ **Remote:** Use cable recommended type CC-01 connected to BUS terminals. Cable length significantly depends on number connected thermal actuators - see table below.

Cable Length for EU-208-A

Cable type	AWG	Resistance Ω /km	Number of actuators	Max. allowable cable length
CC-01 1x2x20 AWG 0,5 mm ² 1x2x24 AWG 0,2 mm ²	20	38	4 8	30 m 15 m
Copper 1 mm ²	17	18	4 8	70 m 30 m
Copper 1,5 mm ²	15	12	4 8	100 m 50 m

Cable Length for EU-206-VFR

Cable type	AWG	Resistance Ω /km	Max. allowable cable length
CC-01 1x2x20 AWG 0,5 mm ² 1x2x24 AWG 0,2 mm ²	20	38	100 m
Copper 1 mm ²	17	18	200 m

The maximum allowable voltage drop on the power supply is 3V ($U_{\min.}=21V$). The maximum allowed data communication distance is 200 m. This is the maximal allowed sum of all cable length in the installation.

Interconnection Cable



When the interconnection cable is used, it is necessary to break out the breakable parts in the CCU's and in EU's front plate. From the backplate nothing has to be removed.

- ◉ The interconnection cable is equipped with two grommets to ensure to protect broken holes in plastic against water and uncontrolled movements of the cable.

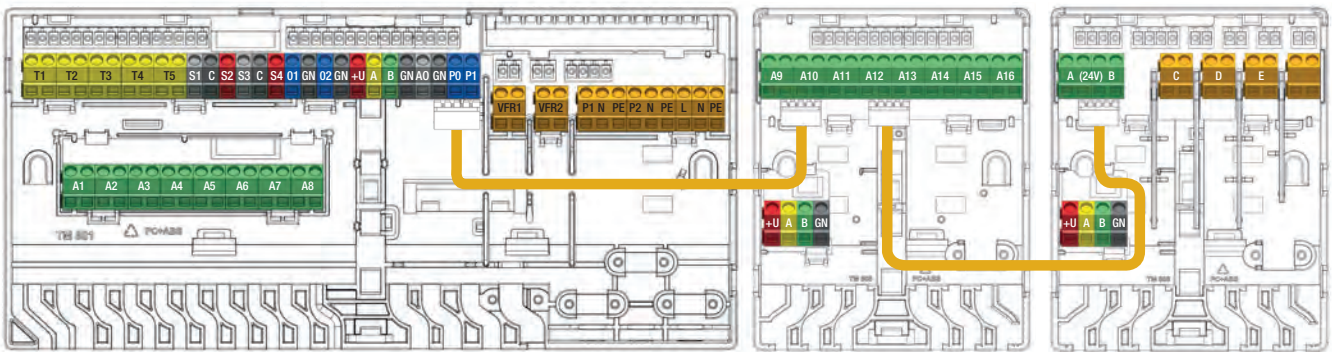

Interconnection cable connections.

 = Breakable

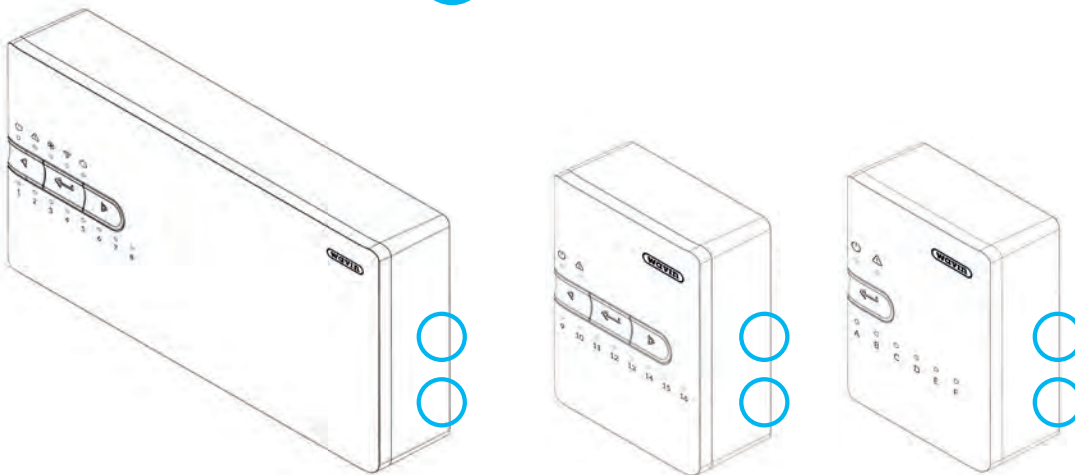

Breakable parts at the front plates when using interconnection cables.

Connecting a Power Supply Cable

- ⤵ The CCU requires a 230V AC 50Hz power supply.
- ⤵ The maximum load by the CCU is 2,3A.
- ⤵ The combined load from the CCU, Circulation pump(s) and heat source when powered by the CCU should not exceed 13A.
- ⤵ The power supply for all interconnected devices, including the heat source and any 3rd party controls, should be isolated from a single point to prevent the risk of electric shock.



The power supply should not be connected until all wiring within the CCU and any interconnected devices is completed.

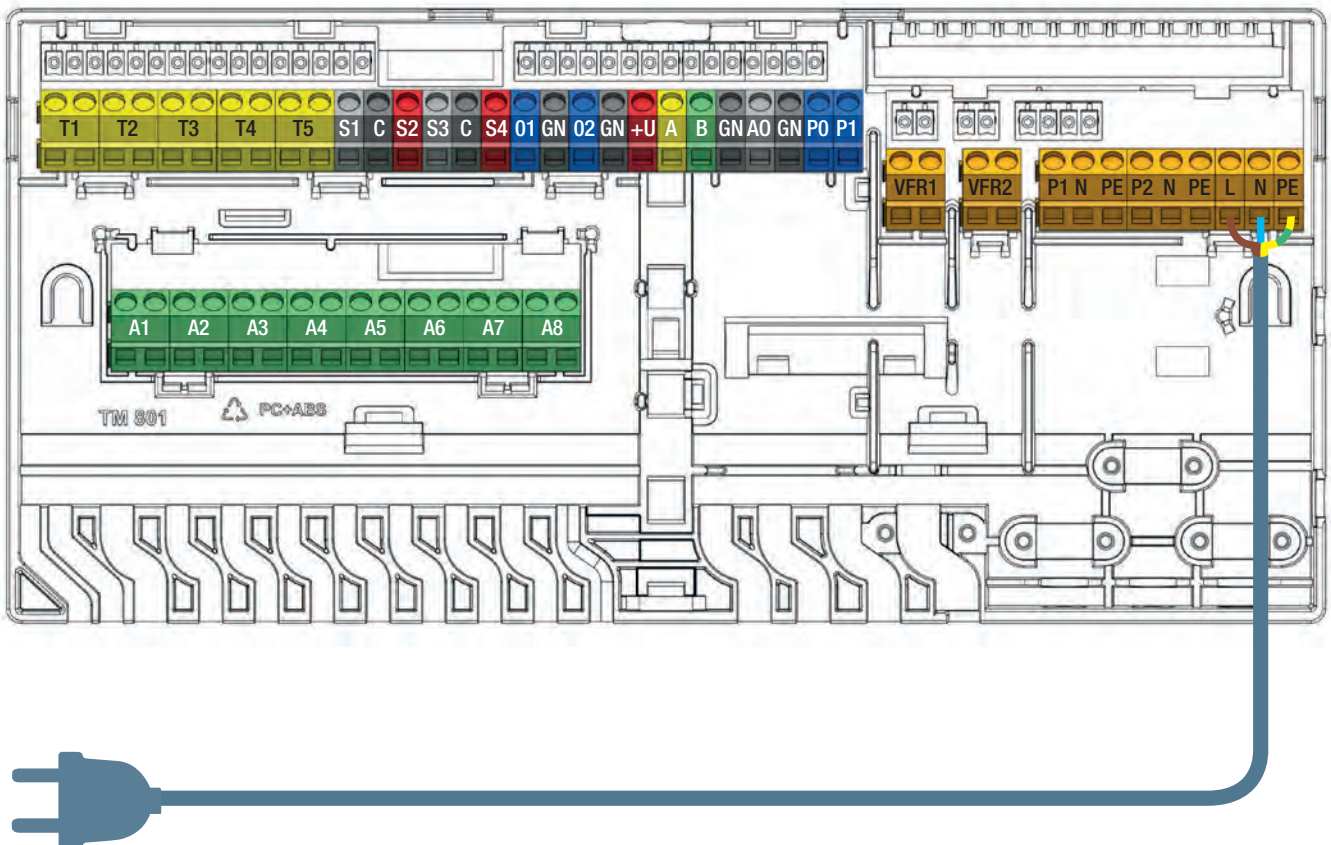

Connecting a power supply cable.

Connecting a Heating or Cooling Source

When connecting to a heating or cooling source the most simple way is to use one of the two Voltage Free Relays (VFR) that are available in the CCU. At the moment the system requires heat or cold this external unit will be switched on until heat/cold demand is not present anymore.

Before using this signal the installer shall check if the external source is suitable to be controlled via ON/OFF control and if so what terminals shall be used.

Contact the supplier in case of questions and validate the connection during the commissioning phase.

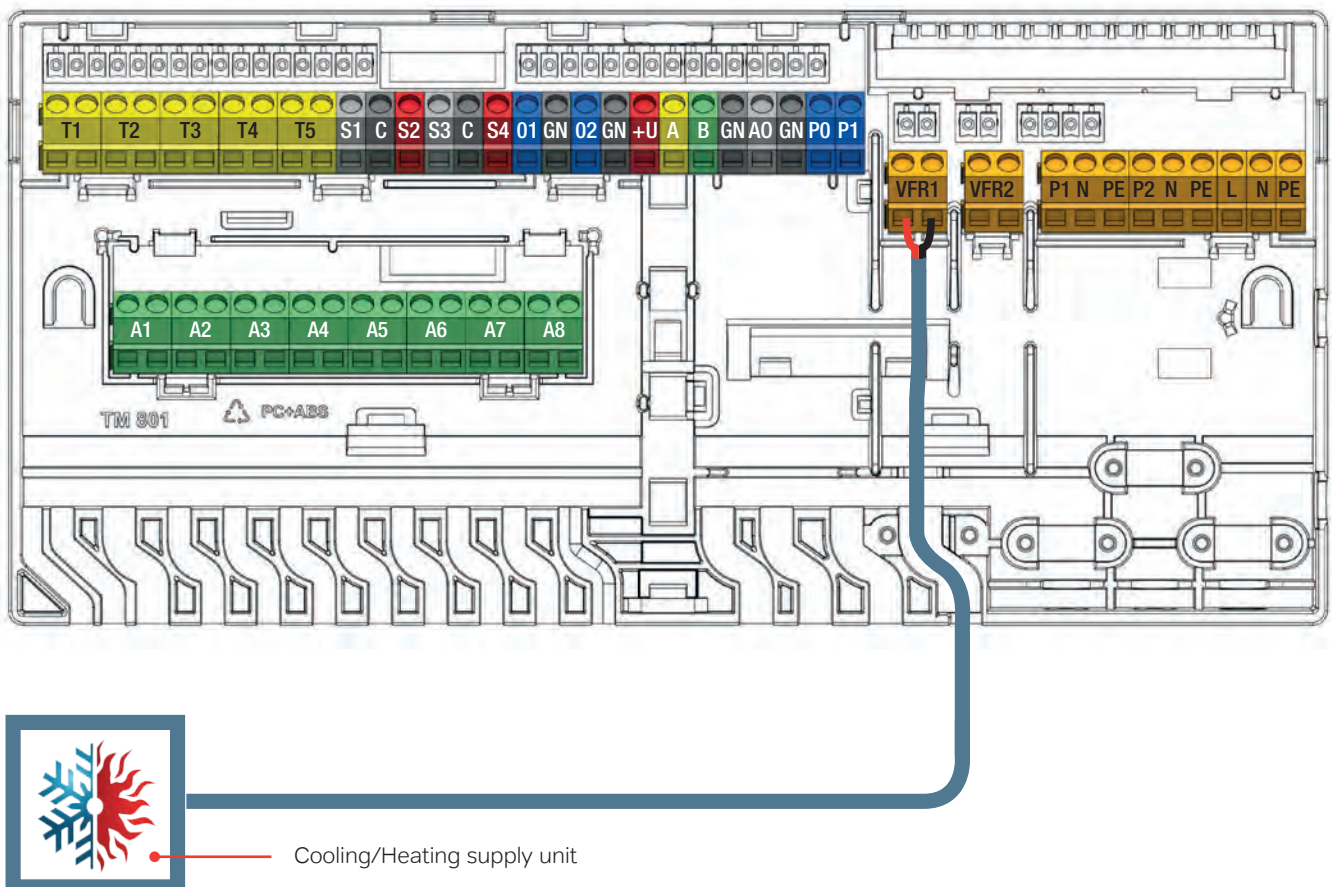

Connecting a heating or cooling source
(example, depending on chosen profile).

Connecting Circulation Pump(s)

The Sentio system provides two switched power supplies for circulation pumps that activate when there is demand coming from any of the connect components assigned to the pump's heating/ cooling circuit. Pumps have by default a start delay of 5 minutes to allow the actuators to open before starting the pump.

- ◉ The CCU is able to control two mixing units (only 230V). Two connections for pumps are foreseen.

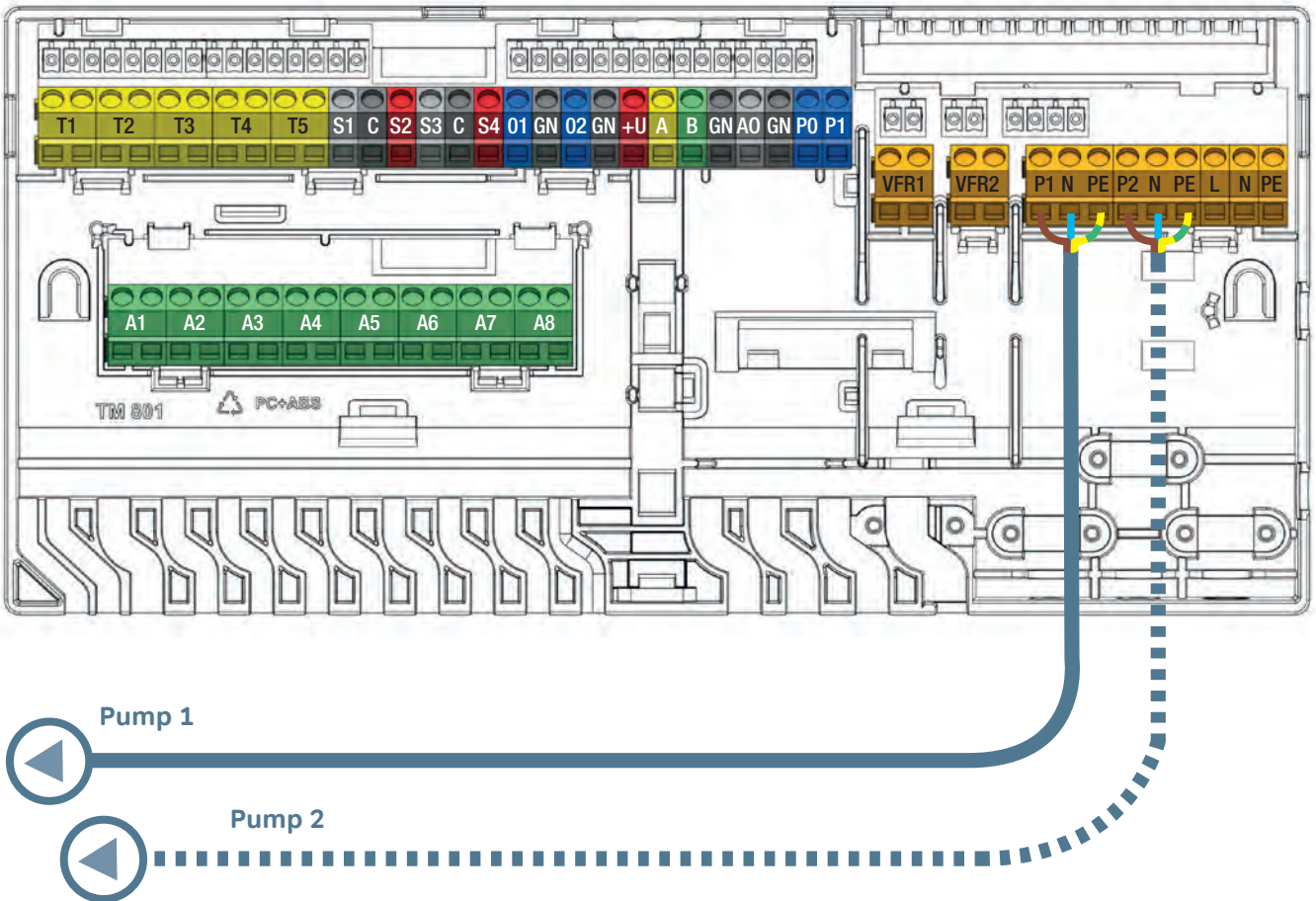

Connecting a mixing/circulation pump.

Connecting 24V Actuators

- ⓘ Install the actuators on the manifold by removing the manual valve cap from the return ports and then pressing the actuator down onto the collar by hand until it clicks into place.
- ⓘ Wavin Actuators are supplied open and will not close until they have been activated for 10 minutes. When the system is powered up, the outputs are checked. When an actuator connection has been detected and it has not done the first time opening yet, the output will be activated for 10 minutes. The outputs will be periodically activated once per week if there has been no activation of an output for at least a week.
- ⓘ If a room thermostat needs to control multiple outputs/actuators, it should be set to operate multiple outputs during the enrolling/pairing process later.
- ⓘ If the load on a single thermoactuator output exceeds 0,5A, the CCU will switch off this output supply and the output LED will indicate an overload (overload protection). For a short period a load of up to 0,6A (inrush current) is allowed.
- ⓘ If the total load on the Control Unit reaches its maximum (also caused by initial higher load at 'cold state' phase) it will begin sequentially switching the outputs off to prevent overloading. This is also used after start-up due to e.g. power failure.
- ⓘ Max. 16 actuators (max. 2 per output) can be connected to one system. Even when a EU-A (max. 1 per output) is used, this limitation of 16 actuators remains.

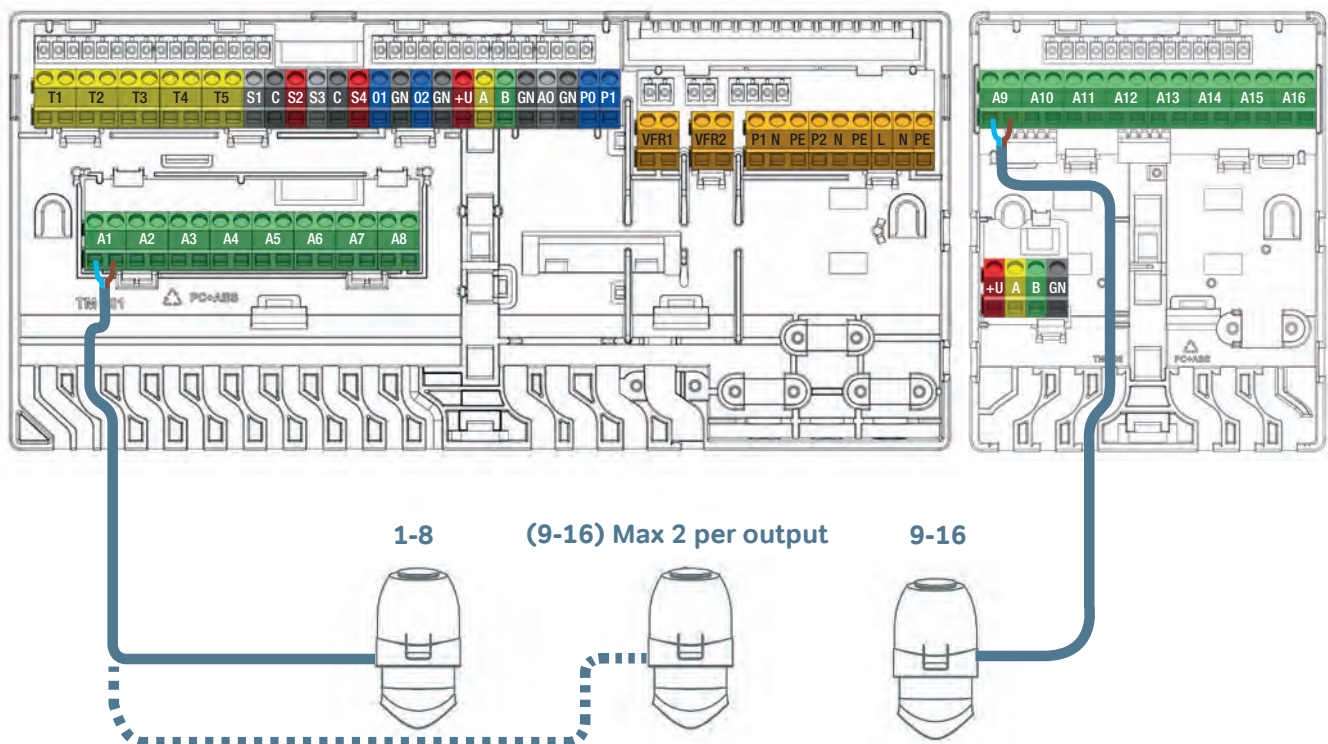

Connecting 24V actuators.



Only Wavin actuators 24V NC can be used.

Connecting Wired Room Thermostats and Sensors

- ⦿ Thermostats require a 4 core UTP Data Cable similar as for EU connection (so CC-01/CC-02 like TP/TS).
- ⦿ Maximum supported cable length is 200 m.
- ⦿ Minimum wire diameter 0,5 mm, minimum wire cross section 0,2mm².
- ⦿ Do not use mains power cable to connect thermostats.
- ⦿ Use of a branching radial circuit will minimize cable usage.
- ⦿ If preferred, each thermostat can use a dedicated cable, however it may be necessary to use a 3rd party junction box at the CCU to connect them all together before connecting to the CCU itself.

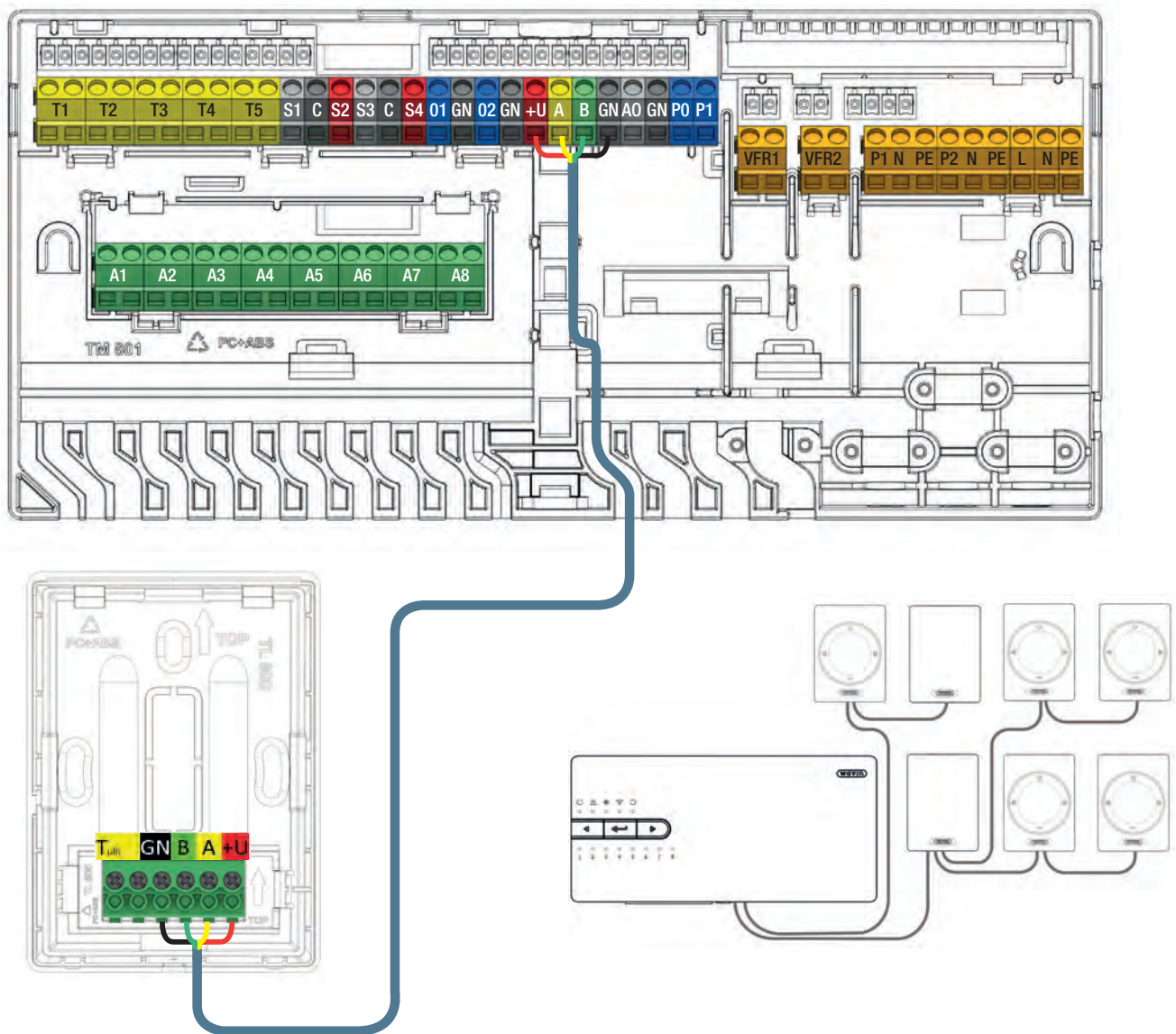

Connecting wired room thermostats and sensors via a BUS cable.

Connecting Wired Floor Sensor

It is possible to connect a wired floor sensor to the wired room thermostat/sensor. For connecting the floor sensor make use of the yellow coded terminals labeled as T^{ufh}.

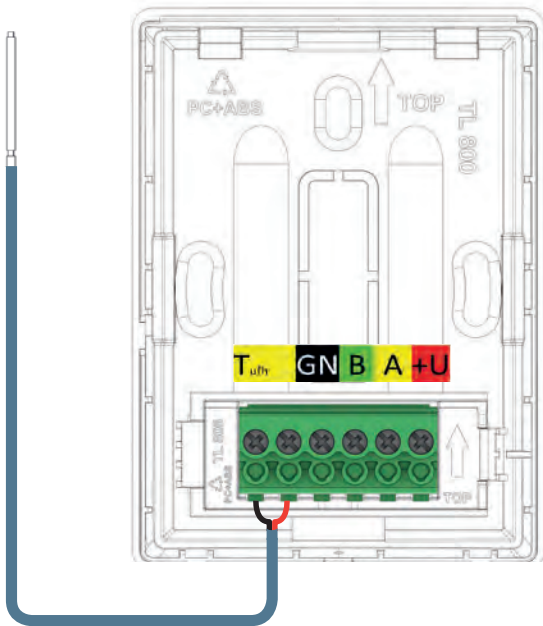

Connecting wired floor sensor.

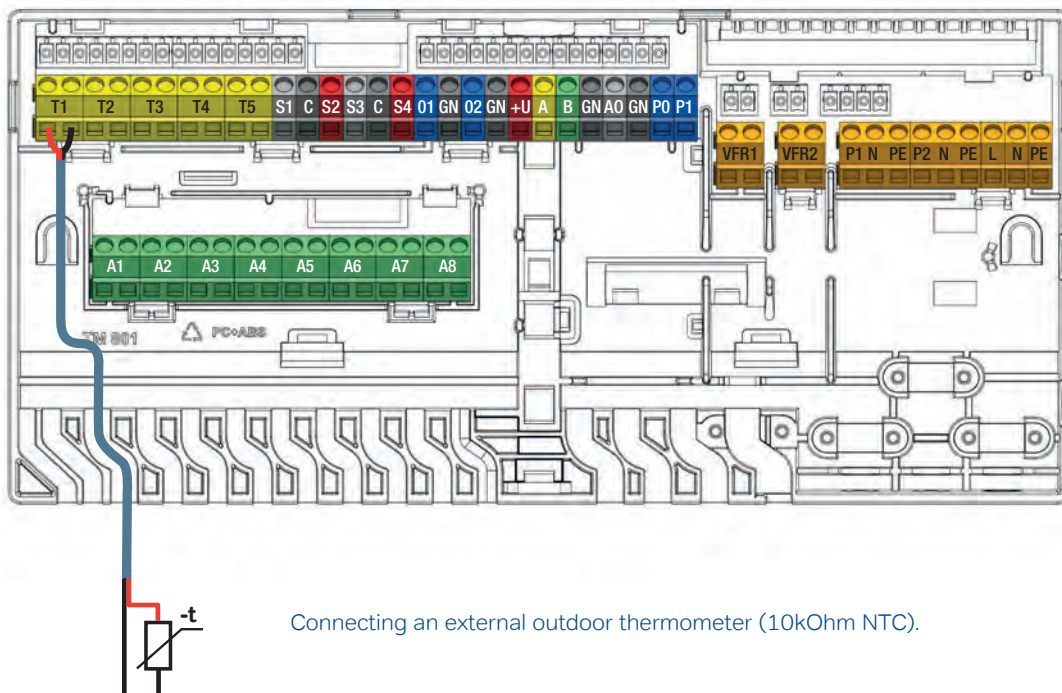

Connecting an external outdoor thermometer (10kOhm NTC).

Connecting a Wired Outdoor Temperature Sensor

Sentio's wired outdoor temperature sensors have to be connected via the wired BUS connection (Terminals +U/A/B/GN). It is possible to connect an extra sensor for situations where the outdoor temperature drops a low as -25 °C. For connecting this extra sensor make use of the yellow coded terminal on the wired outdoor temperature sensor.

- ⦿ The Outdoor Temperature Sensor requires a 4 core UTP Data cable, similar as for the room thermostats.
- ⦿ Maximum supported cable length is 200 m.
- ⦿ Minimum wire diameter 0,5 mm, minimum wire cross section 0.2 mm².

Connecting Wired Outdoor Thermometer

A 10kOhm NTC sensor can be used instead of a Sentio Outdoor Temperature Sensor. A sensor like this will have to be connected to the terminal "T1". These sensors will have to be selected in the commissioning tool.

3.5. Smart Radiator Thermostat

When the Smart Radiator Thermostat is installed it is important for the function of the Smart Radiator Thermostat how and where the Smart Radiator Thermostat is installed.

Independent mode

The Smart Radiator Thermostat has a build-in temperature sensor and can be installed without a room thermostat/sensor in the room. The room temperature will be controlled via the Sentio App or a touch screen at the Central Control Unit.

Dependent mode

If the Smart Radiator Thermostat is installed in such a way that the build-in temperature sensor is not able to measure the real room temperature (e.g. covered/hidden by a curtain/table, mounted vertically etc.) it is possible to combine the Smart Radiator Thermostat with a Sentio room thermostat/sensor.

The build-in temperature sensor in the Smart Radiator thermostat will now be disabled and the room temperature will be controlled via the temperature sensor in the room thermostats/sensor. If you have more than one radiator in a room, it is recommended to use the Smart Radiator Thermostats in combination with a room thermostat/sensor. This will ensure that the heat will even be distributed equally in the room. Both the Smart Radiator Thermostat and the room thermostat/sensor must then be enrolled to the same room. The room temperature can now be controlled directly via the room thermostat, the Sentio App or touch screen of the Central Control Unit.

Manifold mode

The Smart Radiator Thermostat can also be used as a smart actuator at a manifold. This will enable a more efficient energy control and optimized energy consumption for this room. For this function it is required that a room thermostat/sensor is enrolled to the same channel as the Smart Radiator Thermostat is. The build-in temperature sensor in the Smart Radiator thermostat will now be disabled and the room temperature will be controlled via the temperature sensor in the room thermostats/sensor. The room temperature can now be controlled via the room thermostat, via the Sentio App or touch screen of the Central Control Unit.

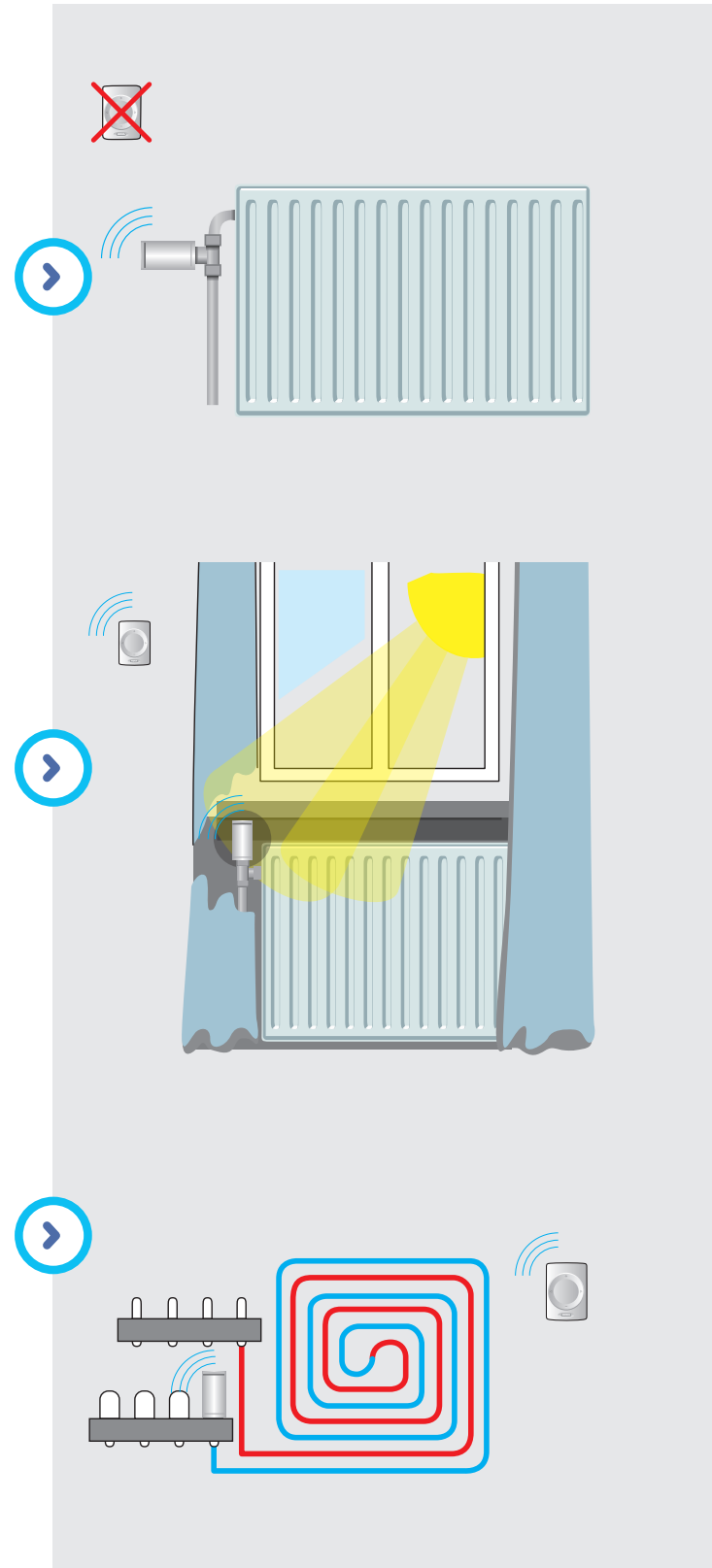

Radiator cooperation

If you have a room with both radiators with Smart Radiator Thermostats and underfloor heating/cooling controlled from the same Central Control Unit, the system can be configured in a more efficient way. In that case the underfloor heating will ensure a basic temperature in the room and at the moment the required temperature is at a certain higher level the radiator will assist. In case the system is in cooling mode, the radiator will be blocked as radiators cannot be used for cooling. For cooperation it is required to have at least one room thermostat/sensor enrolled to the room.

Mounting of Smart Radiator Thermostats

To be able to mount the Smart Radiator Thermostat you first must mount an adaptor (supplied with the Smart Radiator Thermostat) at the radiator valve. The type of adaptor is determined by the manufacturer/type of radiator valve. You can find a compatibility list at paragraph 8.6.

If the actual brand/type of radiator valve is not found in the table, please contact your local Wavin representative.

Mounting of the adapter

When you have selected the correct adapter screw it firmly at the radiator valve (do not use any tools!). If you are installing the RA-78 adaptor, then fasten both Unbraco screws with the Allen key (supplied together with Smart Radiator Thermostat).

Mounting of the Smart Radiator Thermostat

At delivery, the Smart Radiator Thermostat is set in fully open position, this to make the installation possible/easier. If the Smart Radiator Thermostat has been installed before and is not fully opened, then please follow the procedure below to set the Smart Radiator thermostat to the fully open position for easier installing:

- ▶ Open the battery cover.
- ▶ Insert the batteries, the Smart Radiator Thermostat will now start to open fully.
- ▶ Wait a few seconds to the Smart Radiator Thermostat is fully open.
- ▶ Take out the batteries.

You can now easily click the Smart Radiator Thermostat on the adaptor.



Make sure that the Smart Radiator Thermostat is firmly 'clicked' at the adapter by moving it a bit and get this confirmed by trying to pull it off the adaptor.

3.6. Connecting Dehumidifier Units

The extension unit with voltage free relays has to be connected to the CCU via the interconnection cable or via the BUS cable.

- Maximum supported extension units with voltage free relays is 2
- Maximum supported separate dehumidifier units is 4

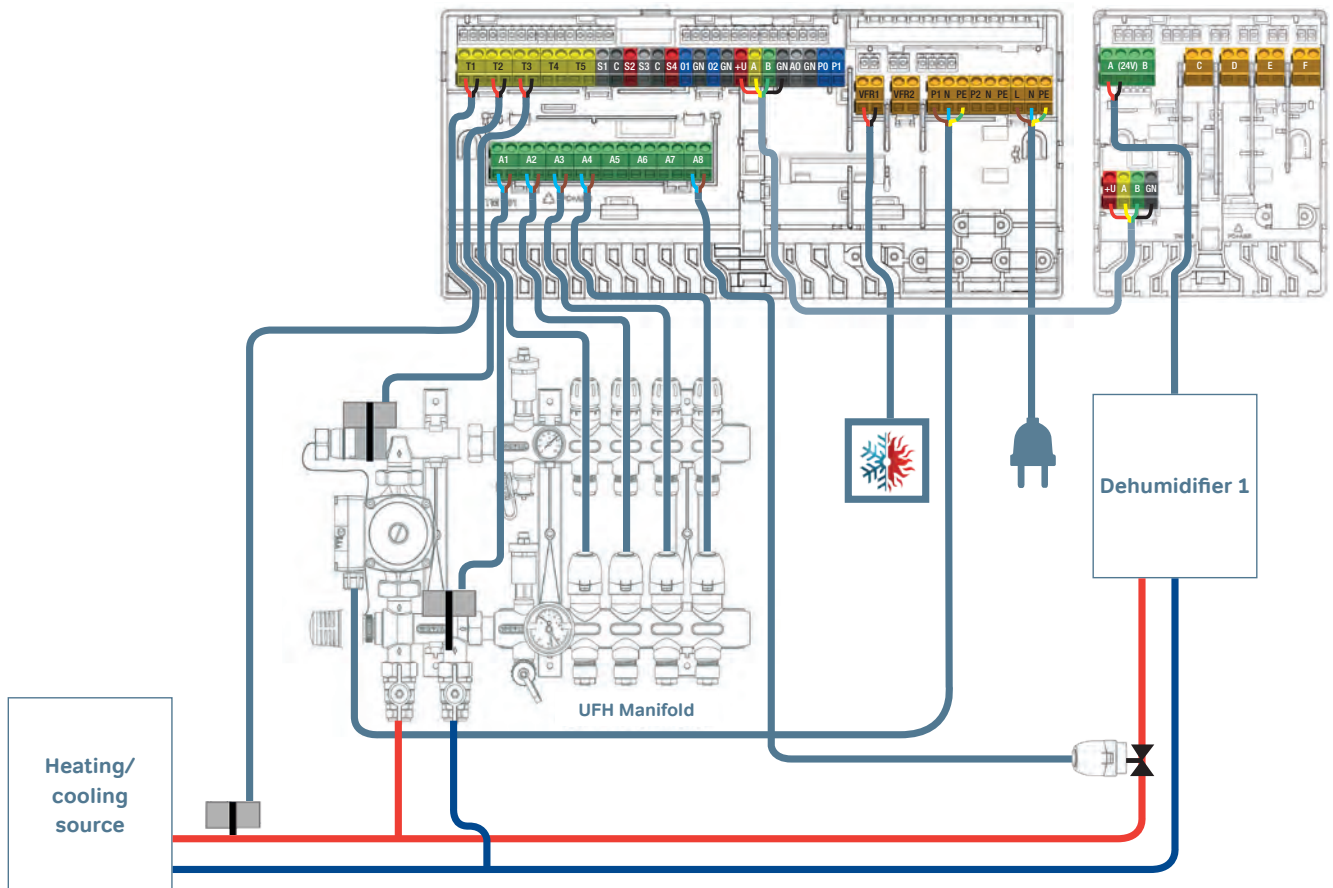

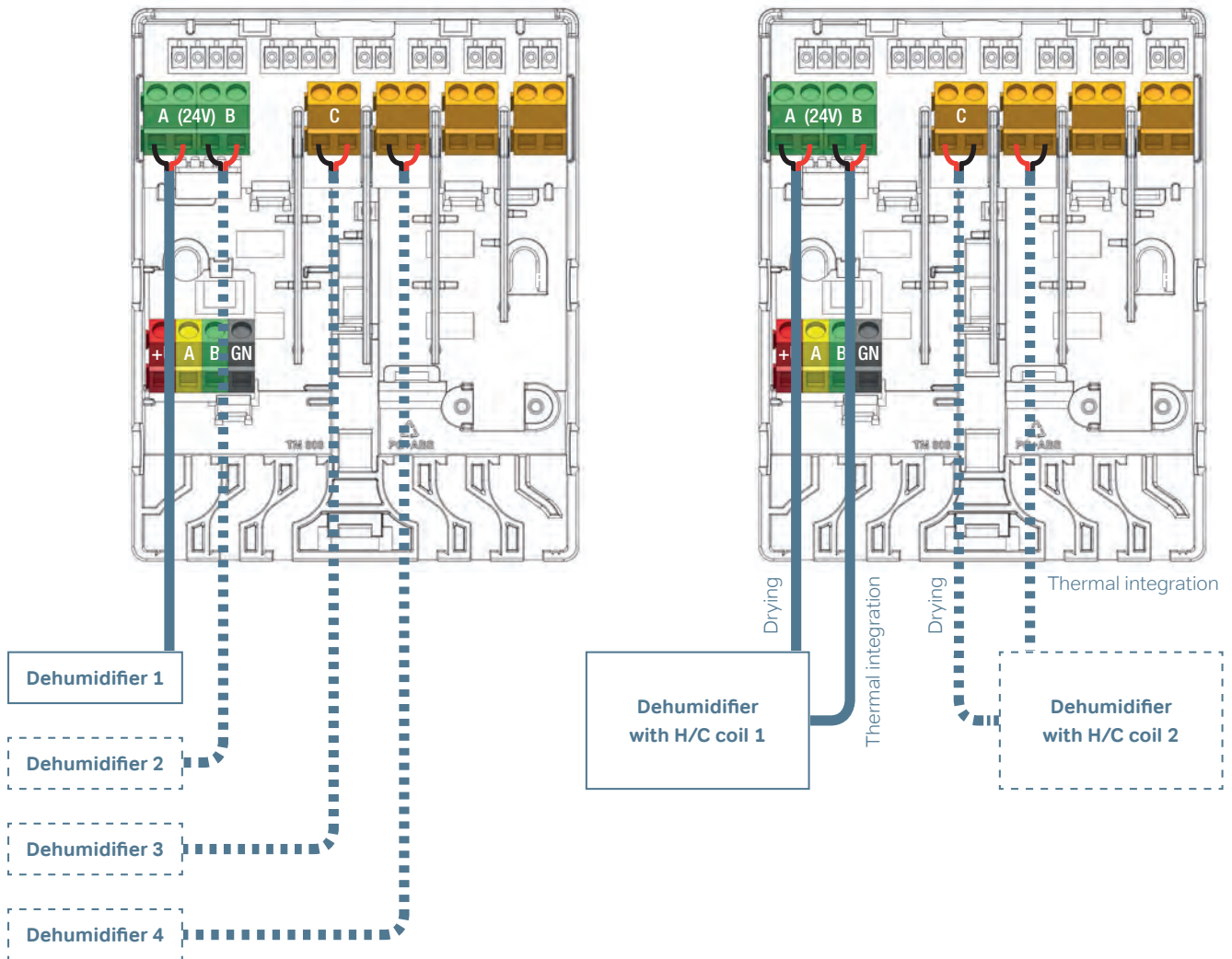

Pre-set	Unit	Drying (D) and Thermal Integration (TI) Connections to Extension Unit (EU-VFR)					
		A	B	C	D	E	F
1.1	1 x Dehumidifier (P/S300)	D					
1.2	2 x Dehumidifier (P/S300)	D	D				
1.3	3 x Dehumidifier (P/S300)	D	D	D			
1.4	4 x Dehumidifier (P/S300)	D	D	D	D		
2.1	1 x Dehumidifier with H/C coil (PC/SC300)	D	TI				
2.2	2 x Dehumidifier with H/C coil (PC/SC300)	D	TI	D	TI		
2.3	3 x Dehumidifier with H/C coil (PC/SC300)	D	TI	D	TI	D	TI

Connecting Inlet/Return Temperature Sensors

Depending on the selected profile the Inlet/Return temperature sensors that are mounted on the mixing unit shall be connected by default to the terminals T2/T4 (Inlet) and T3/T5 return as per the CCU Input/Output list in paragraph 3.4. In paragraph 3.3 the wiring scheme is shown.

An inlet temperature sensor is always advised in order to protect the underfloor heating system from too high temperature, the inlet sensor is mandatory for cooling systems to protect against condensation. The return temperature sensor is not required in most profiles, when this is not used or disabled the input still cannot be used for other purposes.

Connecting the Commissioning Touch Screen / PC Tool

The touchscreen can be connected via the Ethernet cable that is supplied with the touchscreen. The screen has to be connected to one of the RJ45 ports (A or B) on the bottom of the CCU or the EUs. The touchscreen has to be enrolled to the unit. This is described later in this technical handbook.

For the PC commissioning tool the Sention Connection Cable is needed. It has to be added to one of the RJ45 ports as the touch screen.

Connecting to the LAN

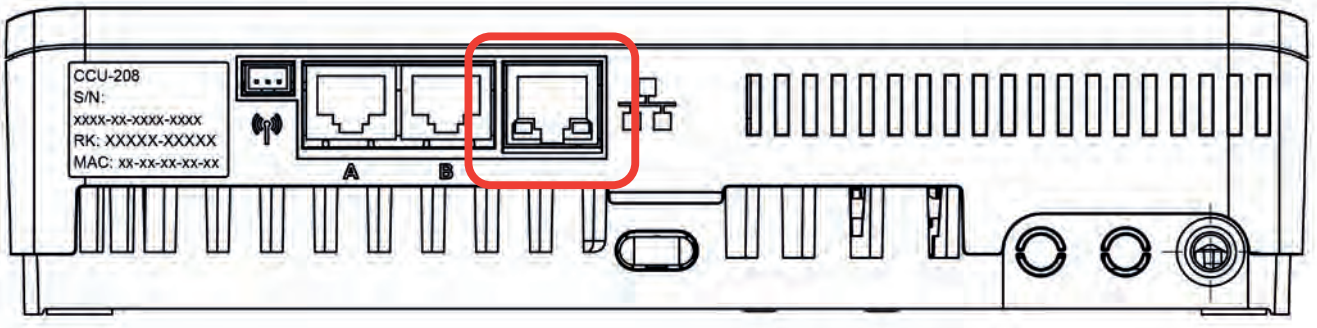

Via an Ethernet cable (not supplied with the control unit) the control unit can be connected to the internet. Connect it to the network or router of the house, to ensure a secure and stable internet connection, as this is not a part of the Sention features and must be provided on side. A Wi-Fi connection is not possible in the current Sention system, however, using an external device a connection to the Wi-Fi network can be made. Wavin is recommending the TP-Link repeater (Art. 4065599) and is providing a connection guide for this device found in the appendix 8.5.

4. Set

4.1. Commissioning

After finishing the CONNECT part the system is connected regarding wiring and ready to move to the next, SET part of the installation. The next step is to commission the system. During the commissioning you will setup the hardware profile, enroll all the room thermostats/sensors and make all the necessary settings of the system.

For commissioning you can use the touch screen or connect a laptop to the CCU. For this option the separately available Sentio Connection Cable is needed. The software (Windows) can be downloaded from the Wavin website. Please go to www.wavin.com/sentio.

When using the ITC functionality, it is recommended to have a dedicated touch screen for the system to improve the monitoring of the system.

Power Up

Before connecting the system to the mains, please check that all control units are connected and firmly closed. Connect the plug to the mains and switch on the power.

First Opening of Actuators

One hour after power up the room's outputs will be checked, when any new actuator connection is detected on the output, the output will be activated for about 10 minutes. Because Wavin 24V actuators are supplied with and First Open function to make installing easier, before the actuators are able to close they have to be activated for at least 10 minutes. For this reason they are activated once after starting the system. The output LED's on the Central Control Unit will turn white to indicate the first opening of the actuator(s).

Setting of outputs

Outputs are assigned to a room when enrolling a room thermostat or sensor. More outputs can be added by enrolling the same room thermostat or sensor again, all the outputs will be assigned to the same room.

In almost every situation outputs are used to control one or two actuators. However, in some cases relays have to be connected to the outputs. For this, use **24V DC** relays and set the output load type to 'relay'. This needs to be done so the safety feature of the Sentio will not flag the output as empty.

For rooms with no actuators, set the output role to 'none'. This will be done automatically if no actuator is detected on the output. In the touch screen go to [Info | Room | associated outputs | Output role / Load type](#).

Factory reset

To reset all the settings to the default values a factory reset function is available. To start this procedure, hold down the enter button on the Central Control Unit for 20 seconds. In this time the channel lights will start to count up, once the count is finished they will turn white and the button can be released to start the factory reset.

4.2. Select a Profile

After starting the system the correct profile will have to be selected. To do this use the commissioning tool (touch screen or PC tool on laptop using the connection cable for PC).

Select a profile in the touch screen or PC tool by going to menu [Systems](#) | [Installer Settings](#) | [Hardware profile](#) | [Change profile](#). Here you can select the profile that best fits the system. After selecting a profile the system will restart and load the selected profile. All the available profiles are shown in the table below. With continues development on the unit check the Sention website for the latest technical handbook with an updated list of profiles.

After the profile has loaded, peripherals can be enrolled and parameters can be set if applicable.

Profile no.	Short application description	Full description in chapter
1.0	UFH together with district heating	4.7
1.1	UFH together a with a boiler / heat pump (On/OFF control)	4.6 / 4.8
1.2	UFH together with a boiler/heat pump (0-10V control)	4.8
1.3.1	UFH together with district heating, and 1 ITC*-circuit	4.7
1.3.2	UFH together with district heating, and district heating, 2 ITC*-circuits	4.7
2.2.1	UFH together with a condensing boiler (ON/OFF or analogue) and 1 ITC*-circuit	4.6 / 4.8
2.2.2	UFH together with a condensing boiler (ON/OFF or analogue) and 2 ITC*-circuits	4.6 / 4.8
3.3.0	UFH/UFC together with a heat pump, manual changeover between heating and cooling	4.6
3.3.1	UFH/UFC together with a heat pump, automatic changeover between heating and cooling	4.6
3.3.2	UFH/UFC together with a heat pump, manual changeover between heating and cooling and 1 ITC* circuit	4.6
3.3.3	UFH/UFC together with a heat pump, automatic changeover between heating and cooling and 1 ITC* circuit	4.6
4.1.1	UFH/UFC together with humidity control and automatic changeover between heating and cooling	4.9
4.1.2	UFH/UFC together with humidity control and automatic changeover between heating and cooling and 1 ITC* circuit	4.9
4.1.3	UFH/UFC together with humidity control and automatic changeover between heating and cooling, 1 ITC* circuit and 1 heating/cooling circuit	4.9
4.1.4	UFH/UFC together with humidity control and automatic changeover between heating and cooling, 2 ITC* circuit and 1 heating/cooling circuit	4.8

All the above mentioned profiles can be combined with the use Smart Radiator Thermostats

* ITC - Inlet Temperature Controller

4.3. Enrolling Peripherals to the System

Before the system can run, all BUS-wired or wireless peripherals, that will give the system its input values, have to be enrolled.

The peripherals are divided into two groups:

1. Global peripherals
2. Local peripherals

Global peripherals are components, whose values are used to control the entire system or peripherals there are used for connecting the different parts of the system.

List of Global Peripherals:

- ▶ Extension Unit A (EU-A)
- ▶ Extension Unit VFR (EU-VFR)
- ▶ Outdoor temperature sensor
- ▶ Touch screen

Local peripherals are peripherals, whose values are used to regulate a single room

List of Local Peripherals:

- ▶ Room thermostats (wired/wireless)
- ▶ Room sensors (wired/wireless)

Enrolling Global Peripherals

Global peripherals need to be enrolled but some of the global peripherals will automatically enroll during the start-up of the system. If there is only one of each of the below mentioned peripherals in a system, the peripheral will be automatically be enrolled during the installation.

Enrolling Extension Units

If you have to enroll an extension unit (EU-A or EU-VFR), please follow the below steps:

1. Press the left arrow button once at the CCU and the "LED for the Global channel"- LED will start flashing red
2. Press the "Return" button at the Extension unit to enroll it. The LED for the Global channel will stop flashing red, and be steady green.

If you have to enroll more than one extension unit, please repeat the above process.

An alternative way of enrolling EUs is enrolling them via their serial number. The number you find on the sticker on the unit.

At the touch screen or the PC tool go to the menu [System | actions | Enroll components | Global channels](#). Press the Next button and tap in the serial number of the EU. After entering in the serial number press "Next" and the unit is enrolled.

Enrolling a Wireless Outdoor Temperature Sensor

To enroll a wireless outdoor temperature sensor, please follow the below steps:

1. Press the left arrow button once at the CCU and the LED for the Global channel will start flashing red.
2. Insert the batteries into the external outdoor temperature sensor. The LED for the Global channel.

An alternative way of enrolling the outdoor temperature sensor is enrolling it via its serial number. The serial number you find on the sticker on the unit.

At the touch screen or the PC tool go to the menu [System | actions | Enroll components | Global channel](#). Press the Next button and tap in the serial number of the outdoor temperature sensor. After entering in the serial number press “Next” and the sensor is enrolled.

Enrolling a Wired Outdoor Temperature Sensor

To enroll a wired outdoor temperature sensor, please follow the below steps:

1. Press the left arrow button once at the CCU and the LED for the Global channel will start flashing red.
2. Assemble the outdoor temperature sensor. Closing it and in consequence connecting it via the bus cable with the CCU will start the learning and the CCU will connect the sensor. The LED for the Global channel will stop flashing red, and be steady green.

An alternative way of enrolling the outdoor temperature sensor is enrolling it via its serial number. The number you find on the sticker on the unit.

At the touch screen or the PC tool go to the menu [System | actions | Enroll components | Global channel](#). Press the Next button and tap in the serial number of outdoor temperature sensor. After entering the serial number press “Next” and the sensor is enrolled.

Enrolling a Touch Screen

If you have to enroll a touch screen, which usually is done automatically, please follow the below steps:

1. Press the left arrow button once at the CCU and the LED for the Global channel will start flashing red.
2. Press the “Learn” button at the touch screen. The LED for the Global channel at the CCU will stop flashing red, and be steady green.

Enrolling Local peripherals

Before the system can function, the local peripherals shall be enrolled to the CCU or an EU-A.

Rules for enrolling local components

You can enroll up to 24 wired or wireless components to the CCU. Multiple components can be enrolled to the same channel. By enrolling one thermostat to more channels, you connect the channels and they act like one channel. If you later enroll another room thermostat/sensor to one of the connected channels, the room thermostat/sensor will be enrolled to all the connected channels.

Enrolling of wireless room thermostats

Wireless room thermostats can be enrolled in several different ways depending on your wish.

Please follow the below steps to enroll wireless room thermostats **without** using the touch screen:

1. Select the channel you want to enroll the room thermostat to by repeatedly pressing either the left or right button at the CCU or the EU-A until the corresponding LED starts flashing red.
2. Insert the batteries into the room thermostat. When the room thermostat is enrolled to the control unit the room thermostats shows the channel number followed by “enrolment OK”.

or

3. Touch and hold the room thermostat's touch area until the room thermostat shows the channel number followed by "enrolment OK".

When the room thermostat is enrolled, the corresponding LED, stops flashing red and turns into steady red or green.

Please follow the below steps to enroll wireless room thermostats using the touch screen:

1. At the Sentio Touch screen or in the PC-software go to the menu [System | Actions | Enroll components | Component to a new room](#). Select here to which CCU or EU you want to enroll the room thermostat to and at what channel or channels. The corresponding LED at the CCU or EU starts flashing red.
2. Press next button. At the display you can now enter the room thermostat's serial number. You can find the serial number on a sticker in the left battery bay (seen from behind) at the room thermostat.. Press the "Next" button at the touch screen.

When the room thermostat is enrolled the corresponding LED stops flashing red and turns into steady red or green.

Enrolling of wireless room sensors

Wireless room sensors can be enrolled in several different ways depending on your wish.

Please follow the below steps to enroll wireless sensors **without** using the touch screen:

1. Select the channel you want to enroll the room sensor to by repeatedly pressing either the left or right button at the CCU or the EU-A until the corresponding LED start flashing red.
2. Insert the batteries into the room sensor. When the room sensor is enrolled to the CCU the LED at the room sensor turns into steady red or green.

or

3. Touch and hold at the room sensor's touch area until the room sensor's LED turns into steady red or green.

When the sensor is enrolled the corresponding LED on the CCU stops flashing red and turns into steady red or green.

Please follow the below step to enroll wireless sensors using the touch screen:

1. At the touch screen or the PC tool go to the menu [System | actions | Enroll components | Component to a new room](#). Select here to which CCU or EU you want to enroll the sensor to and at what channel or channels. The corresponding LED at the CCU or EU starts flashing red.
2. Press next button. At the display you can now tap in the sensors serial number. You can find the serial number on a sticker in the left battery bay (seen from behind) at the sensor. Press the "Next" button at the touch screen. When the sensor is enrolled the corresponding LED, stops flashing red and turns into steady red or green.

Enrolling of wired room thermostats

Wired room thermostats can be enrolled in several different ways depending on your wish.

Please follow the below steps to enroll wired room thermostats without using the touch screen:

1. Select the channel you want to enroll the room thermostat to by repeatedly pressing either the left or right button at the CCU or the EU-A until the corresponding LED start flashing red.
2. Touch and hold at the room thermostat's touch area until the room thermostat shows the "Enrolment OK" icon followed by the "Channel number".

When the room thermostat is enrolled the corresponding LED, stops flashing red and turns into steady red or green.

Please follow the below step to enroll wireless room thermostats using the touch screen:

1. At the touch screen or the PC tool go to the menu [System | actions | Enroll components | Component to a new room](#). Select here to which CCU or EU you want to enroll the room thermostats to and at what channel or channels. The corresponding LED at the CCU or EU starts flashing red.
2. Press next button. At the display you can now enter the room thermostat's serial number. You can find the serial number on a sticker at the backside of the front part of room thermostat. Press the "Next" button at the touch screen.

When the room thermostat is enrolled the corresponding LED, stops flashing red and turns into steady red or green.

Enrolling of Wired Room Sensors

Wired room sensors can be enrolled in several different ways depending on your wish.

Please follow the below steps to enroll wired sensors **without** using the touch screen:

1. Select the channel you want to enroll the sensor to by repeatedly pressing either the left or right button at the CCU or the EU-A until the the corresponding LED start flashing red.
2. Touch and hold at the room sensor's touch area until the room sensor's LED turns into turns into steady red or green.

When the sensor is enrolled, the corresponding LED stops flashing red and turns into steady red or green.

Please follow the below step to enroll wired sensors **using** the touch screen:

1. At the Sentio touch screen or the PC tool go to the menu [System | actions | Enroll components | Component to a new room](#). Select here to which CCU or EU you want to enroll the sensor to and at what channel or channels. The corresponding LED at the CCU or EU starts flashing red.

2. Press next button. At the display you can now enter the room thermostat's serial number. You can find the serial number on a sticker at the backside of the front part of room thermostat. Press the "Next" button at the touch screen.

When the sensor is enrolled, the corresponding LED on the CCU stops flashing red and turns into steady red or green.

Enrolling of Dehumidifiers

Dehumidifiers are only possible to be enrolled in profiles 4. To enroll a dehumidifier, please follow the steps below:

- ① In the touch screen or PC tool navigate to: [System | Actions | Add device/function](#)
- ② Select the Extension Unit that the dehumidifiers are connected to
- ③ Select what is connected to your EU-VFR from a list of pre-defined units or add one unit manually.

If there is a combination of Dehumidifiers and dehumidifiers with thermal integration, first select a pre-set group that fit best for the first few units, then continue adding the other units manually.

Enrolling of Smart Radiator Thermostats

Before the Smart Radiator Thermostat can be used it needs to be enrolled to the CCU. It is possible enroll max. 16 Smart Radiator Thermostats to a single Sentio system.

Rooms without a physical output (actuator) ("Virtual rooms")

As the Smart Radiator Thermostat is not physical connected to the CCU/EU-A, it shall be enrolled to rooms/channels. When correctly enrolled (to an empty room) the CCU/EU-A channel will stop flashing red and show purple.

The Smart Radiator Thermostats can also be enrolled to rooms/channels not shown on the CCU/EU-A by using the touch screen.

Smart Radiator Thermostats can be enrolled in two different ways depending on your preferences.

Please follow the steps below to enroll Smart Radiator Thermostat without using the touch screen:

1. Select the channel you want to enroll the Smart Radiator Thermostat to by repeatedly pressing either the left or right button at the CCU or the EU-A until the corresponding channel LED starts flashing red.
2. Insert the batteries into the Smart Radiator Thermostat. When the Smart Radiator Thermostat is enrolled to the control unit, the corresponding channel LED at the CCU/EU-A will stop flashing red and turns into steady red or purple.

Please follow the steps below to enroll Smart Radiator Thermostat using the touch screen:

1. At the Sentio touch screen or the PC tool go to the menu [System](#) | [Actions](#) | [Enroll components](#). Select here to which room you want to enroll the Smart Radiator Thermostat. The corresponding channel LED at the CCU/EU-A starts flashing red. Press Next button.
2. Select if you want to enroll the Smart Radiator Thermostat to other rooms than the room you first selected. If not, then press the "Skip" button else press the "Next" button.
3. Select the way you want to enroll Smart Radiator Thermostat
4. If you have selected to enroll the Smart Radiator Thermostat by a learn signal from the Smart Radiator Thermostat, insert the batteries into the Smart Radiator Thermostat

or

If you have selected to enroll the Smart Radiator Thermostat by entering the serial number, you can now enter Smart Radiator Thermostat serial number found on a label under the middle battery in the Smart Radiator Thermostat. Press the "Next" button at the touch screen.

When the Smart Radiator Thermostat is enrolled, the corresponding channel LED on the CCU stops flashing red and turns into steady red or purple.

Remove Peripherals

If a peripheral, global or local, has to be replaced or you want to setup the system in a different way, you need first to delete the peripheral from the system. To delete a peripheral, please follow the below steps:

Global Peripherals

If you delete a global peripheral connection it can affect the functionality of the complete system. If you delete e.g. an EU-A from the CCU, all the outputs of the room thermostats/sensors that prior to this have been enrolled to the EU-A will be offline.

If you have to delete an EU-A or EU-VFR using the touch screen or the PC tool, please follow the below steps:

1. At the touch screen or the PC tool go to the menu [System](#) | [Actions](#) | [Remove components](#) | [Global component](#).
2. Chose the extension unit or the units you want to delete and press the "remove" button.

If you don't have a Sentio touch screen or laptop tool it is still possible to delete global peripherals.



By removing a global peripheral as described below, ALL their enrolled peripherals will be offline and this will have impact on the functionality of the whole system.

1. Press the left arrow button once at the CCU and the LED for the Global channel will start flashing red.
2. Press and hold the "Enter" button at the CCU for approx. 3 sec. and the LED for the Global channel will stop flashing and will be turned off.

Local Peripherals

If you delete a local peripheral, it will only affect the channel it is enrolled to. If the local peripheral is enrolled to more than one channel and you delete it, it will be deleted from all the channels it is enrolled to.

If you have to delete a single local peripheral (room thermostat/room sensor) from a room, using the touch screen or the PC tool, please follow the below steps:

1. At the touch screen or the PC tool go to the menu [System | Actions | Remove components | Component associated to a room](#).
2. Chose the peripheral you want to delete and press the "Next" button.

If you have to delete all local peripherals (room thermostat/ room sensor) from a room, using the touch screen or the PC tool, please follow the below steps:

1. At the touch screen or the PC tool go to the menu [System | Actions | Remove components | Room and associated components](#).
2. Chose the room or rooms you want to delete and press the "Next" button.

If a local peripherals must be removed without a LCD, please follow the next steps:

1. On the CCU or EU-A select, by using the arrows, the channel from which the peripherals shall be removed. When a channel is selected, it is indicated by a red flashing LED.
2. Complete the removal by pressing the "Enter"-button for approx. 3 seconds. The removal is completed when the LED of the selected channel stopped LED for the selected channel and turned off.

Remove a Smart Radiator Thermostat from a CCU/EU-A

If you remove a Smart Radiator Thermostat, it will only affect the channel it is enrolled to. If a Smart Radiator Thermostat is enrolled to more than one channel it will be removed from all the channels it is enrolled to when removed.

If you must remove a single Smart Radiator Thermostat from a room, using the touch screen or the PC tool, please follow the steps below:

1. At the touch screen or the PC tool go to the menu [System | Actions | Remove components](#)
2. Select the Smart Radiator Thermostat you want to remove and press the "Next" button.

If a Smart Radiator Thermostat must be removed without using a touch screen, please follow the following steps:



Warning! All components enrolled to the selected channel will be removed, not only the Smart Radiator Thermostat.

1. On the CCU or EU-A select, by using the arrows, the channel from which the Smart Radiator Thermostat shall be removed. When a channel is selected, it is indicated by a red flashing LED.
2. Complete the removal by pressing the "Enter"-button for approx. 3 seconds. The removal is completed when the LED of the selected channel stopped flashing and turns off.

Enrolling of Ventiza ventilation units

Ventilation units can be enrolled in any profile. To enroll a ventilation unit the system has to have Modbus set to Master. This can be done in the touch screen connected to port B by going to: [System | installer settings | Modbus configuration](#)

When Modbus is set to master, follow the steps below to enroll the ventilation: In the touch screen or PC tool navigate to: [System | Actions | Add devices/functions | Ventilation](#)

Select the type of ventilation that is being used from the list, select 'add'.

Ventilation is now enrolled, for more settings see the ventilation settings in the touch screen by going to: [System | Functions | Ventilation](#)

4.3.1 Outdoor temperature sharing

When multiple Sentio systems are installed in the same area, for example in apartment buildings, there is the option to use one Sentio Wireless Outdoor Sensor for all of the systems in range. This way there only has to be a single Wireless Outdoor Sensor installed. For this function the Wireless Outdoor Sensor needs to be at least firmware TQ61108.5 and each connected Central Control Unit needs to be at firmware TM60014 or higher. To update the Wireless Outdoor Sensor, first enroll it to one system (see paragraph 4.3 – enrolling outdoor sensor) and do the automatic update (see paragraph 6.2). When all products have the minimal required firmware, simply enroll the Wireless Outdoor Sensor to all Central Control Units. If the connection cannot be made to multiple units, It is very likely that the other Central Control units are not yet updated to the minimal firmware revision required for this functionality.

4.4. User Interfaces

4.4.1. User interface for the Control Unit (CCU) and the Extension Units (EUs)

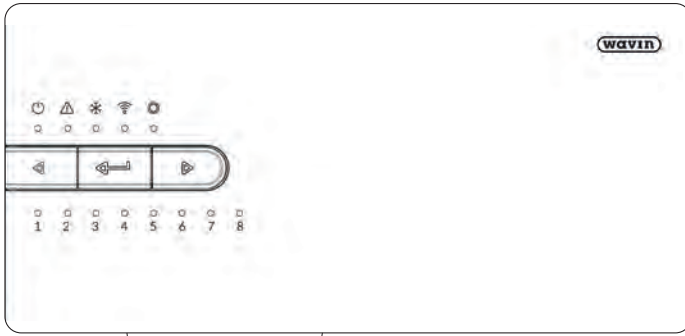

CCU

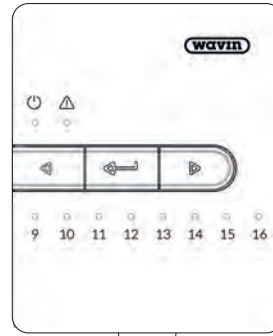

EU-A





EU-VFR



The CCU can be used for heating and cooling buildings systems. The settings of the CCU can be made by using the touch screen. Basic settings and diagnostics can also be made by buttons and LEDs on the units. See paragraph 8.1 for a Frequently asked Questions & Answers table.

Buttons on the CCU and EUs

Basic settings can be made via the CCU and EUs. Three different buttons ensure this functionality.

Sign	Button	Function
	Left arrow	Select a channel by moving it to the left
	Enter	Confirm action, Learn mode to connect to the APP, Reset a channel (hold 10s), Factory Reset (hold 20s)
	Right arrow	Select a channel by moving it to the right

The LEDs on the units give an information about the systems status on a short glance. First diagnostics usually can be done by considering the information shown by the LED as well as using them. Where flash is 0.5 Hz and fast flash 4 Hz.

LED	Function	Light	Meaning
	Status	Off	No power supply of the unit
		Green On	Power on – everything ok
		Red On	Bootloader is working
	Warning	Yellow flash	Error, e.g. connection to peripheral lost
		Yellow slow flash	Bootloader is working / preparing for update
		Yellow fast flash	Update is running
	Cooling	Blue On	Cooling is active
	LAN status	Green On	Connected to LAN and cloud service
		Green flash	Connected to LAN but no cloud service
		Green fast flash	Learn mode active for registering unit to the app
		Red fast flash*	Learn mode active for registering unit to the app
		Blue On	Auto update has found a new version and is ready to update
		Blue flash	Auto update is ready to check for a new version
		Blue fast flash	Auto update is checking a new version
			Global components
Green Flash	Global peripheral missing		
Red flash	Enrolling mode (global peripherals can be enrolled)		
1 – 16	Actuator channels	Red On	Heating
		Green On	Idle – no heating / no cooling
		Blue On	Cooling
		Purple On	Idle – Room without thermal actuator; e.g. room with Smart Radiator Thermostat
		Cyan On	Idle – Output used for special purposes e.g. External Actuator
		Red flash	Enrolling mode (peripherals can be enrolled)
		Red fast flash	Output overloaded, heating demand
		Green flash	Missing periphery
		Green fast flash	Output overloaded, idle, no demand
		Blue fast flash	Output overloaded, cooling demand
		Green/red	Heating is blocked, e.g. because outdoor temperature is too high
		Green/blue	Cooling is blocked, e.g. because outdoor temperature is too low
		Purple/red	Heating is blocked for room without thermal actuator
		Cyan/red	Heating is blocked for an output with special purpose
		Cyan/blue	Cooling is blocked for an output with special purpose
		White slow flash	Periodic activation (preventive maintenance)
		White	First time opening of thermal actuators
		Yellow	Changing profile settings / restart / updating peripheral
A – F	VFR channels	Green On	VFR set and ready
		Red on	VFR active

* Hardware version 8 and higher

4.4.2. User Interface for the Room Thermostats and Sensors

Detailed information about the daily use of the room thermostats/sensors can be found in the manuals supplied with the components and shown in the Appendix 8.2 and 8.3 of this document. In Appendix 8.5 detailed information regarding the room thermostat symbols can be found.

4.4.3. User interface for the Room Thermostats and Sensors

Information for everyday use can be found in the user manual provided with the product. A copy of the user manual for the thermostats and sensors can be found in the Appendix of this manual at paragraph 8.2 and 8.3. When setting up a system it is sometimes necessary to adjust some settings on the room thermostat in order to optimize to the situation. These advanced settings can have influence on the system's way of working and are therefore intended to be set by the installer only. The interface has been split over three levels, with more impactful settings harder to access.

Thermostat Information

Information about the room thermostat is shown here. To access this level hold down any one point on the room thermostat ring for 5 seconds. Here is shown what room it is connected, the battery status and signal strength to the Central Control Unit(CCU). Holding down any point while showing room number will enroll the room thermostat to a room on the CCU if a room has been selected on the CCU.

Common Settings

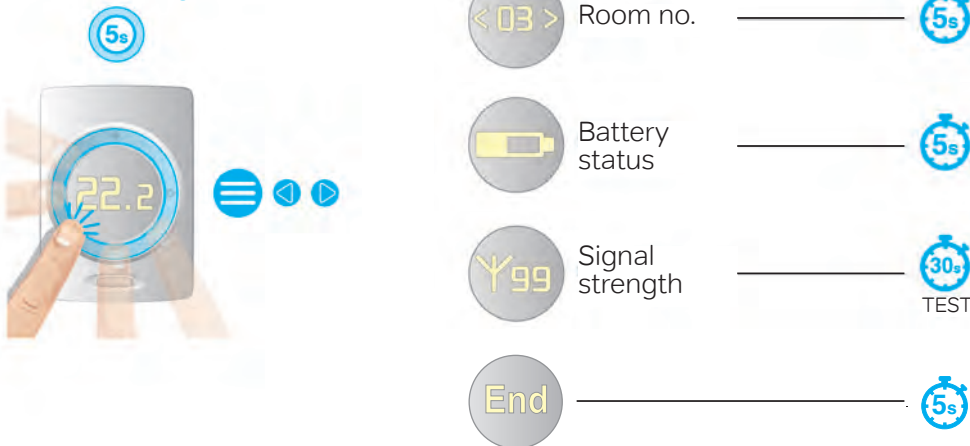

Description	Adaptable Range	Step Size	Default Setting
Correction of room temperature sensor	± 5,0 °C	0,1 °C	0,0 °C
Correction of floor temperature sensor	± 5,0 °C	0,1 °C	0,0 °C
Correction of room humidity sensor	± 5,0 %	1 %	0,0 %
Auto brightness level	1 - 5	1	1 (low), 5 (high)
Touchpad sensitivity	1 - 3	1	2 = Med

Advanced Room Settings

To open these settings hold up and down simultaneously for 5 seconds until a tool symbol appears. Here are some settings that might need to be changed some time after commissioning the system if user experience demands some small adjustments. These options include the allowed range of temperature setting, this will limit the temperatures that can be set on the room thermostat, and the temperature regulation mode (only with a floor temperature sensor). With this regulation mode can be chosen which temperature is leading, by default this is always the air temperature. But when for example sensitive floors are used in combination with underfloor heating having the floor temperature leading might be saver. With the 'Air + Floor' regulation the air temperature will be leading in achieving the selected temperature, while the floor temperature will be kept between a minimum and a maximum limit. These advanced options are also available to the user via the Sentio APP.

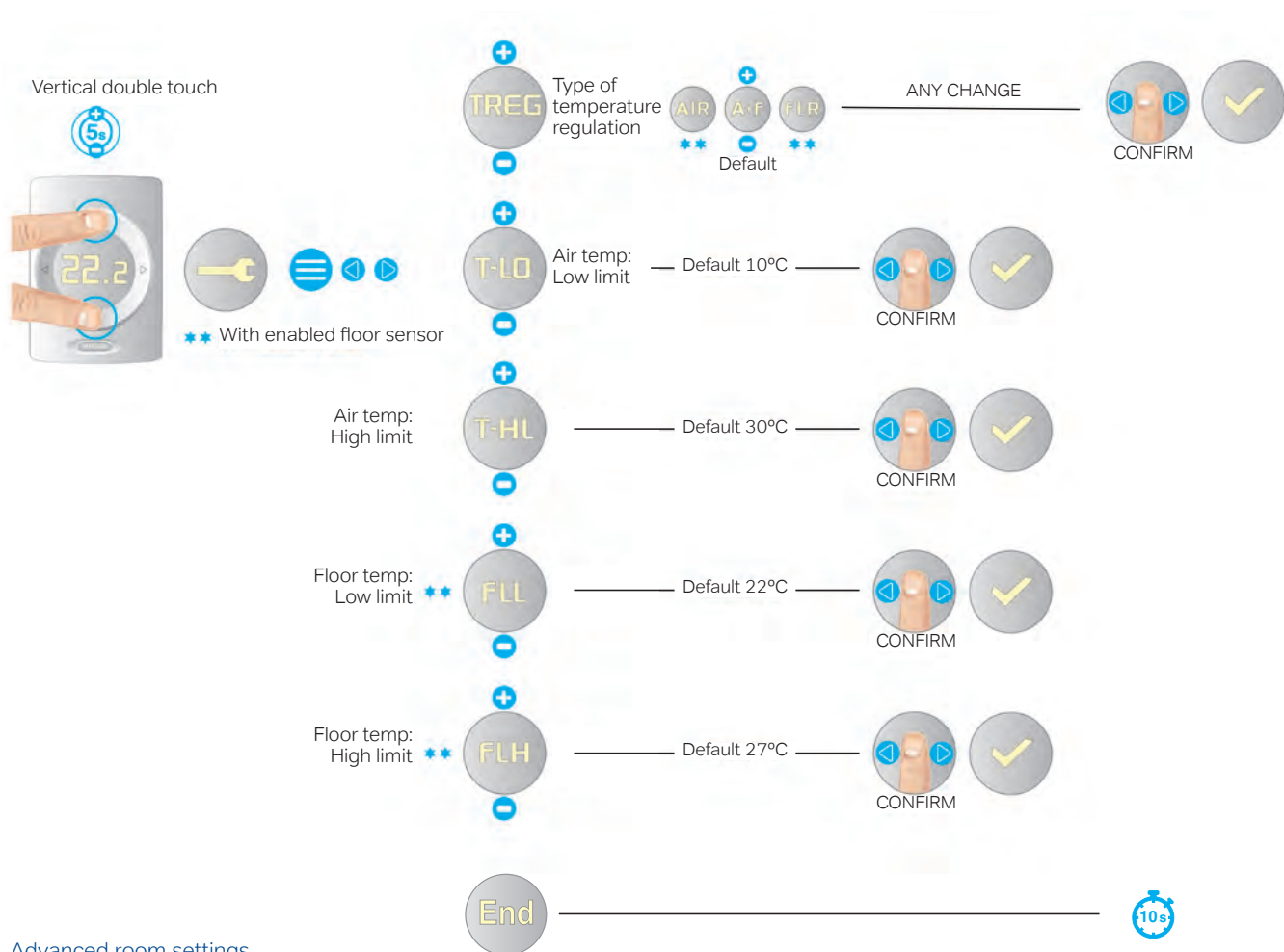

Advanced room settings.

Description	Menu	Setting options	Factory default	Notes
Type of temperature regulation (Only available if a thermostat/sensor with floor temperature is used).	TREG	AIR (OFF)	AIR	Regulation based on the air temperature
		A+F (ON)		Regulation based on the air temperature and floor limits
		FLR (REG)		Regulation based on the floor temperature
Allowed range of user air temperature settings	T-LO	+6°C to T-HI	10.0 °C	1°C step
	T-HI	T-LO to +40°C	30.0 °C	
Floor temperature limit low (min)	FL-LO	6°C to 40°C	22°C	step 0.5°C, 22°C = comfort on tiles floor
Floor temperature limit high (max)	FL-HI	6°C to 40°C	27°C	step 0.5°C, 27°C = floor hygienic limit Rule: FL-LO < FL-HI

Room temperature regulation in heating mode

In heating mode and with room thermostats/sensors with floor sensors, it is possible to select between three types of room temperature regulation.

1. Regulation upon the air temperature
2. Regulation upon the air temperature with floor temperature limits
3. Regulation upon the floor temperature

1. Air temperature regulation:

- Manual, Eco, Comfort, Extra comfort, Holiday and Standby mode.
- The floor sensor is not enabled
- The room temperature is controlled only by the air temperature sensor inside the room thermostats/sensor

2. Air + Floor temperature regulation:

Manuel, Comfort, Extra comfort and Holiday mode

- The floor sensor is enabled
- As long as that the floor temperature is between the “Low floor temp limit” and the “high floor temp limit” the room temperature is controlled only by the air temperature sensor inside the room thermostats/sensor
- If the room temperature is reached but the floor temperature is below the “low floor temp limit” the system will continue heating until the “low floor temp limit” is reached
- If the room temperature is not reached but the floor temperature is over the “high floor temp limit” the system will stop heating. The system will start heating again when the floor temperature is below the “high floor temp limit”

Eco and Standby mode

- The floor sensor is enabled

- The “low floor temp limit” is set lower.
- As long as that the floor temperature is between the “Low floor temp limit” and the “high floor temp limit” the room temperature is controlled only by the air temperature sensor inside the room thermostats/sensor
- If the room temperature is not reached but the floor temperature is over the “high floor limit” the system shall stop heating.

The system shall start heating again when the floor temperature is below the “high floor temp limit”

3. Floor temperature regulation

- Manual, Eco, Comfort, Extra comfort and Hotel mode
- The floor sensor is enabled
- The room temperature is controlled only by the floor sensor
- The air temperature is not used for temperature control. It is shown on room thermostat display, touch screen and Sentio App as an information
- The set temperature for the floor temperature cannot be set lower than “low floor limit” +1 °C
- The set temperature for the floor temperature cannot be set higher than “high floor limit”-1 °C

Thermostat Settings

To enter the settings hold up and down simultaneously for about 10 seconds, when a tool appears keep holding until the tool points to the left. To align all room thermostats and reduce the impact of the specific circumstances of their location the temperature display of air temperature, floor temperature and humidity can be adjusted. These corrections can also be set using the commissioning tool touch screen. Furthermore, the sensitivity of the touchpad can be adjusted to the local circumstances as well. It can be set to three different levels (low, medium, high).

The room thermostats are equipped with an ambient light sensor that provides an appropriate display intensity in accordance with the ambient light and ensures a good visibility on direct day light and not too intense light in darkness. This display dimming can be adapted to the personal preferences. Five different levels of brightness are available. One is the lowest, five the highest. You can as well adapt the lowest level as the highest level that fit to the individual preferences. When lowest and highest level are the same no adaption on ambient light takes place. Furthermore, all room thermostat settings can be reset to the factory defaults. During the reset also the connection to the CCU is checked. If there is no response from the CCU, e.g. the room thermostat is located too far away or the CCU is powered off, the room thermostat is set back to the not connected status.

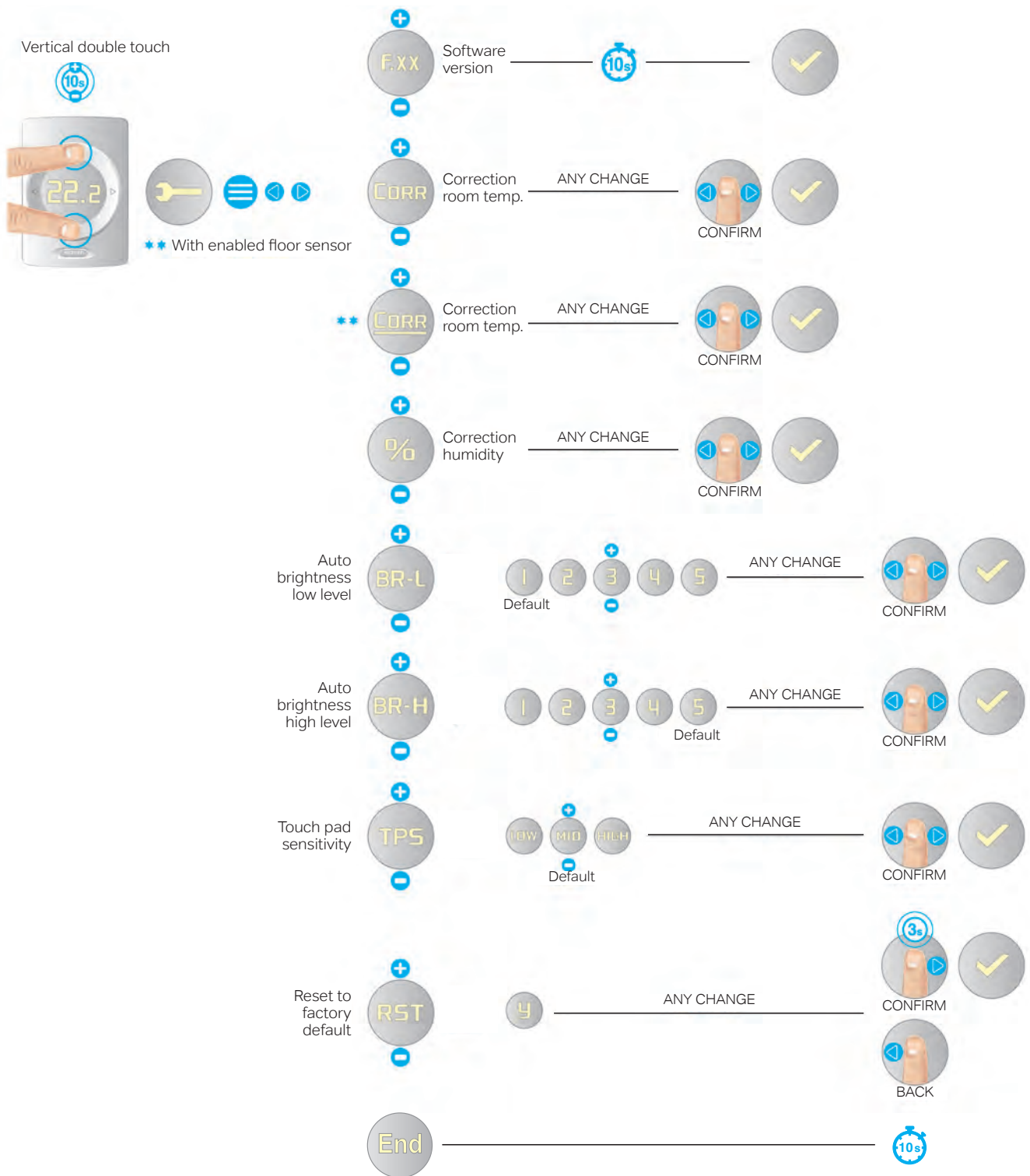

Thermostat settings.

Status Indicator and Symbols for Warnings and Errors

Both the room thermostats and sensors are equipped with an status indicator.
By touching the touch area an LED shows the current status.

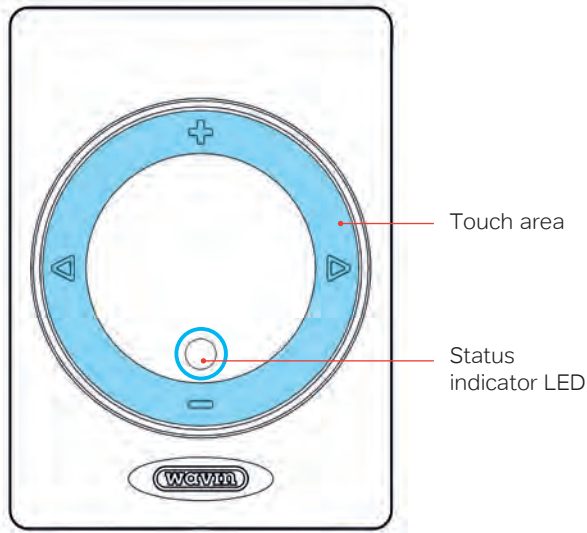

Touch area and status indicator thermostat.

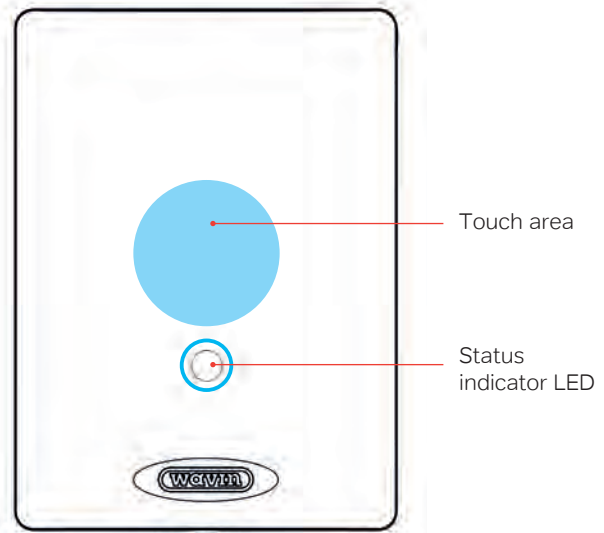

Touch area and status indicator sensor.

Status	Awake mode (after touching the touch area)		
	Colour	Lighting style	
Warning	Yellow	Slow flashing	== == == ==
Low battery	Yellow	Fast double flash	== == == ==
Not enrolled	Red	Fast flashing	== == == ==
CCU not responding	Red	Fast flashing	== == == ==
Error	Red	Fast flashing	== == == ==
Idle - no heating / no cooling	Green	On	=====
Heating	Red	On	=====
Cooling	Blue	On	=====
Heating blocked	Red-green	Alternately	== . == . == . == .
Cooling blocked	Blue-green	Alternately	== . == . == . == .

Warning

Warnings – yellow LED

For the sensor, warning meaning can be found in the touch screen, PC tool or mobile App.

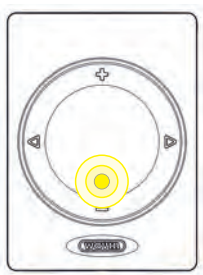

SIGN	MEANING	RECOMMENDED ACTION
	General warning	<ul style="list-style-type: none"> Check the system for abnormalities
	Low battery	<ul style="list-style-type: none"> Replace batteries
	Floor heating blocked by floor security limit (overheating)	<ul style="list-style-type: none"> Reduce the allowed inlet temperature or the set room temperature (depending on the general system settings)
	Cooling blocked by dew point reasons	<ul style="list-style-type: none"> The humidity and temperature conditions in the room would have negative impact on the building. Therefore, cooling is stopped. Choose a higher room or inlet temperature (depending on the general system settings)
	Too low air temperature	<ul style="list-style-type: none"> The current temperature is out the set spectrum of allowed temperatures. Select a higher one.
	Too high air temperature	<ul style="list-style-type: none"> The current temperature is out the set spectrum of allowed temperatures. Select a lower one.

Error

Errors - red LED flashing*



SIGN	MEANING	RECOMMENDED ACTION
	General error	<ul style="list-style-type: none"> Check the system for abnormalities, could indicate a damaged sensor.
	Lost connection, wireless	<ul style="list-style-type: none"> Check if there are radio interferences, local drops or other items disturbing the connection.
	Lost connection, bus powered device	<ul style="list-style-type: none"> Check the bus connections
	Enroll process not successful	<ul style="list-style-type: none"> Check if there are interferences disturbing the connection, locate the peripheral nearby the CCU

*A constant red LED is no error. It indicates that the room is being heated at the moment.

4.4.4. Standby Temperature

The standby mode functions is a ‘building protection’ as described in EN15500. A low temperature can be set for the whole system which will prevent the system from having heat demand or freezing. This temperature cannot be changed on the room thermostats.

The standby mode can be started from the Sention App or the touch screen.

The standby temperature can be set on the App and or on the touch screen via [Room | settings | advanced settings | Standby temperature](#)

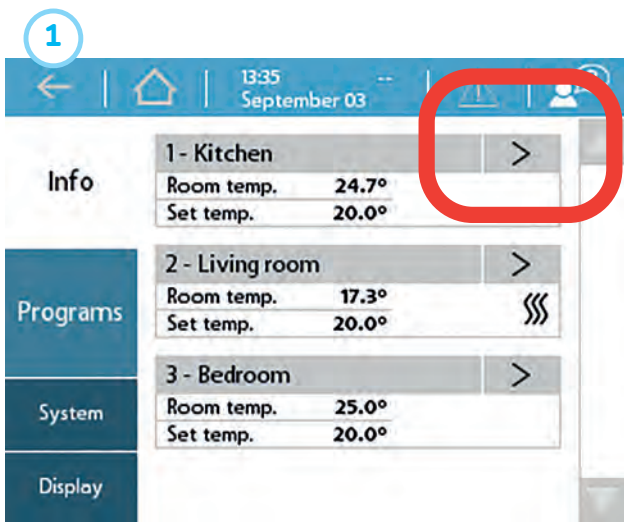

4.4.5. Hotel Mode

A special mode is available for facilities where users shall only be able to adapt the temperature but nothing else as e.g. in hotels.

The room controller can be set to Hotel mode in the central control unit e.g. via the touch screen or laptop.

In this room mode the room thermostat user interface significantly changes its behaviour. It is only possible to see and to set the room temperature. Other selections are suppressed.

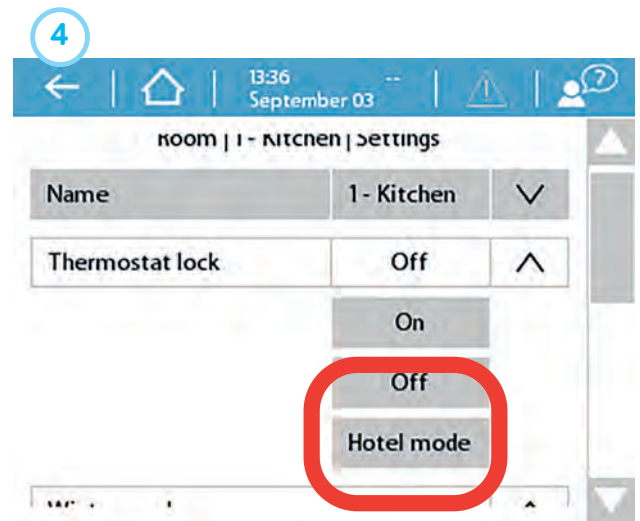
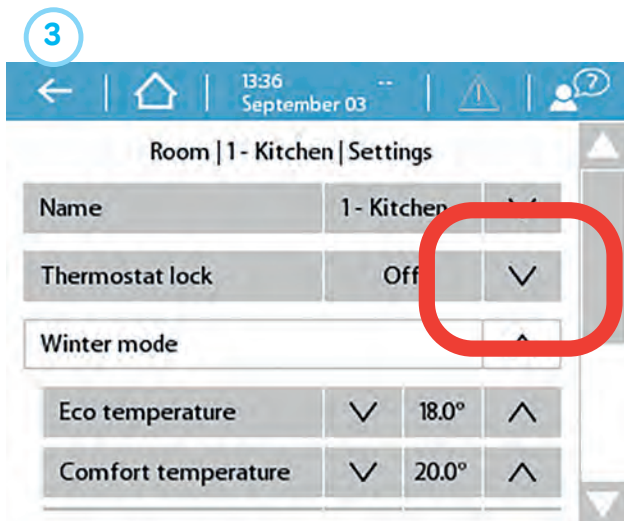
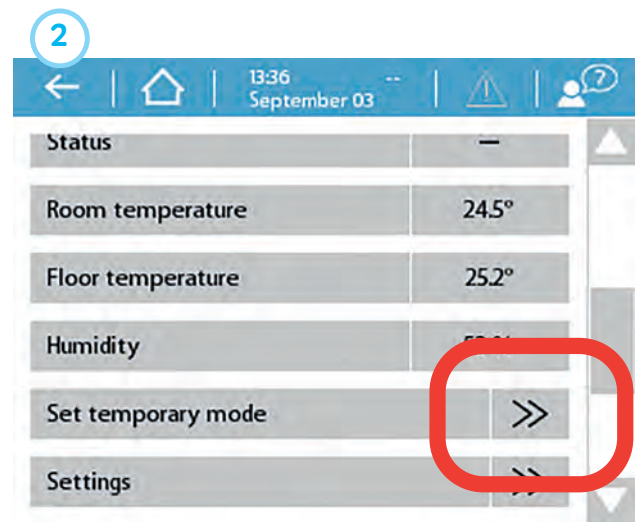

4.4.6. Sentio Modbus RS485

Sentio can be integrated into Building Management Systems (BMS) using a Modbus connection. Sentio's RJ45 port A can be set to Modbus communication using the touch screen. Various modes can be set, but Sentio will always be a Modbus Slave device to the BMS. Sentio is not a BMS itself, so can't integrate other devices as a BMS would. It is not possible to take over the underfloor heating controls, Sentio will still be in control of the heating/cooling system. It is expected from the BMS integrator to know what values need to read out from Sentio.

Setting the system to Modbus 'Master' will allow for connection of Wavin Ventiza ventilation units. Read more on ventilation in chapter 4.10. With Modbus Master activated it will no longer be possible to connect Sentio as slave device to a BMS via Modbus RTU.

To connect to Sentio via Modbus enable Modbus slave on port A by using the touch screen and going to [System | Installer settings | Modbus Configuration | Modbus mode](#). Then connect to Sentio using an RS485 connection, keep in mind that the pin connections are not the same as for common Modbus systems.

For more details on the connection and Sentio's Modbus registers see the dedicated Modbus Manual found in Appendix 8.8.

4.4.7 Sentio Modbus TCP/IP

In firmware version TM60014 and higher it is possible to use Modbus TCP over IP. Both the Central Control Unit (CCU) and touch screen commissioning tool need to be at firmware version 14 or higher. Registers for TCP/IP are the same as for Modbus RTU over RS485. Use the LAN port to make a connection to the network and activate the Modbus TCP function in the touch screen by going to [System | Installer Settings | Modbus configuration | Modbus TCP](#).

4.5. Sentio Applications

4.5.1. Heating & Cooling Services

Why using Sentio & Hydronic Underfloor Heating as an Application

Underfloor heating is a form of central heating (can be combined with cooling) which achieves indoor climate control for thermal comfort using conduction, radiation and convection. The terms radiant heating are commonly used to describe this approach because radiation is responsible for a significant portion of the resulting thermal comfort but this usage is technically correct only when radiation composes more than 50% of the heat exchange between the floor and the rest of the space

The Sentio system is developed dedicated for this heating and cooling of residential and non-residential area's based upon zone-control. In each room a room thermostat or sensor is installed that measures the temperature. Based upon this actual temperature and the desired (SET) temperature the Sentio system takes care for heating (and if the system is equipped with cold water supply also for cooling) of this room.

Heating a room with an underfloor heating system is rather efficient and more and more commonly accepted as it is able to create comfort based upon low temperature (LT) heating water. In general the water temperature is below 50°C. Due to the large contact area the air in the room is heated steadily without creating any airflow (like with high temperature systems). Therefore less movement of dust inside the room.

Conditions of Use

The profiles for underfloor heating are based upon the following conditions:

- ④ The underfloor heating system is connected to a manifold and/or mixing unit
- ④ The underfloor heating pipe is suitable for hydronic heating (water or mixture with water)
- ④ The underfloor heating system is designed (pipe size, pipe design, etc.) in such a way that it creates enough heating capacity for a comfortable indoor climate based upon applicable standards
- ④ The underfloor heating system is installed by qualified installers

How to Connect

The Sentio system comprises the underfloor heating system (pipes/insulation/ etc, see www.wavin.com) and the complete mixing unit (including manifold). The zone-control is installed based upon the design of the underfloor heating system (see chapter 1) and in each room a room thermostat/sensor is located and connected to the corresponding manifold output connection. More than 1 output connection can be linked to one room and to one room thermostat/sensor.

How to Set

The most important aspect is to ensure that each room has its own room thermostat/sensor that is connected (wired or wireless) with the central control unit of the Sentio system. It is important to notice that it is crucial that the underfloor heating zones per room are correctly enrolled/connected to the room thermostat/sensor in that room. If this is not the case heat-demand in a certain room can result in heating another room. Therefore during the commissioning this aspect shall be checked carefully before the system is handed over to the end-user.

Selection of profile and parameter settings to be done by the installer. Future settings are possible via the touch screen (optionally available for the end-user) or via the installer.

NOTE: The installation and commissioning of the underfloor heating system is the responsibility of the installer. Once installed and commissioned Wavin does not advise to change the parameter settings unilaterally.

How to Go

The Sentio system can be controlled via the room thermostats/sensors in each room, via the Sentio app and if required via the touch screen. Once installed the end-user can control the indoor climate comfort in each room.

4.5.2. Sentio & Underfloor cooling (UFC)

Why using Underfloor Cooling as an Application

Underfloor cooling is a form of central cooling which achieves indoor climate control for thermal comfort using conduction, radiation and convection. The terms radiant cooling are commonly used to describe this approach because radiation is responsible for a significant portion of the resulting thermal comfort but this usage is technically correct only when radiation composes more than 50% of the cooling exchange between the floor and the rest of the space. Compared to central heating (in many cases heating & cooling is combined in one system) the design of central underfloor cooling shall be in such a way that cooling capacity is sufficient. Compared to underfloor heating this implies larger diameter, pipes laid closer to each other or a combination of but in principle and more pipe length/meter underfloor cooling system.

In combined heating/cooling systems the cooling efficiency is lower compared to the heating efficiency. This is caused by the smaller temperature difference between inlet and return water temperature that can be achieved. Underfloor cooling is limited by several factors and one of them is the relative humidity in relation with the actual room temperature. This is resulting in a dewpoint temperature that limits the cooling water temperature especially during periods in which high humidity and high air temperature exists. This limits the cooling capacity.

The Sentio system is developed for this type of cooling of residential and non-residential area's based upon zone-control. In each room a room thermostat/sensor is installed that measures the temperature. Based upon this actual temperature and the desired (SET) temperature the Sentio system takes care for cooling in this room.

Cooling a room with an underfloor cooling system is rather efficient and more and more commonly accepted as it is able to create comfort based upon chilled/cold water. Due to the large contact area the air in the room is cooled steadily without creating any airflow (like with high temperature systems). Therefore less movement of dust inside the room.

Conditions of Use

The profiles for underfloor cooling are based upon the following conditions:

- ④ The underfloor cooling system is connected to a manifold and/or mixing unit
- ④ The underfloor cooling pipe is suitable for hydronic heating (water or mixture with water)
- ④ The underfloor cooling system is designed (pipe size, pipe design, etc) in such a way that it creates enough cooling capacity for a comfortable indoor climate based upon applicable standards. In combination with underfloor heating the capacity of the cooling system will be lower.
- ④ The underfloor cooling system is installed by qualified installers
- ④ An inlet sensor needs to be present on the manifold or supply pipe for dewpoint protection based on humidity per room.
- ④ The Sentio system is able to deal with manual switch over between heating and cooling (via external switch, via software or via Modbus) or automatically based on outdoor temperature.

How to Connect

The Sentio system comprises the underfloor cooling system (pipes/insulation/ etc, see www.wavin.com) and the complete mixing unit (including manifold). The zone-control is installed based upon the design of the underfloor cooling system (see chapter 1) and in each room a room thermostat/sensor is located and connected to the corresponding manifold output connection. More than 1 output connection can be linked to one room and to one room thermostat/sensor.

A pipe sensor must be placed on the supply side of the manifold or on the supply pipe of the system. The sensor has to be connected to port T2 for circuit 1 and on T4 for circuit 2. Follow the instructions provided with the sensor for the installation details.

How to Set

The most important aspect is to ensure that each room has its own room thermostat/sensor that is connected (wired or wireless) with the central control unit of the Sentio system.

Selection of profile and parameter settings to be done by the installer. Future settings are possible via the touch screen (optional available for the end-user) or via the installer. It is important to notice that it is crucial that the underfloor heating zones per room are correctly enrolled/connected to the room thermostat/sensor in that room. If this is not the case cooling-demand in a certain room can result in cooling another room. Therefore during the commissioning this aspect shall be checked carefully before the system is handed over to the end-user.

NOTE: The installation and commissioning of the underfloor cooling system is the responsibility of the installer. Once installed and commissioned Wavin does not advise to change the parameter settings unilaterally.

How to Go

The Sentio system can be controlled via the room thermostats/sensors in each room, via the Sentio app and, if and if required, via the touch screen. Once installed the end-user can control the indoor climate comfort in each room.

Switching to cooling can be done automatically based on outdoor temperature or via an external switch. It is possible to switch to cooling via the LCD touch screen and APP once allowed by the installer. To give permission the installer can use the LCD touch screen and go to [System | Installer settings | Hardware profile | Priority of H/C switch](#) and set this to SW for a software switch rather than the external hardware switch.

4.5.3. Sentio & radiators

Why using Sentio & radiators

In many buildings, radiators are either used main source of heat in a room or in combination with under floor heating. By combining both types of heating systems at the same time the benefits from each will be used. Radiators can act fast at heating demand, but also offer very concentrated heat, where under floor heating often will react slower to a heat demand, but often gives a higher comfort in the room. With the Sentio Smart Radiator Thermostat you can control each single radiator and/or combine the two types of heating systems and let

the systems in a smarter way work together to reach optimal comfort temperatures.

Condition of use

It is possible to add Smart Radiator Thermostats to all preset hardware profiles in the Sentio Central Control Unit. Be aware that radiators cannot be used for cooling but can still be a part of the heating system.

Water pressure must be in line with instructions by the radiator valve manufacturer, typically between 1 and 2 bar.



When the Sentio system switch from heating mode to cooling mode, the radiators will be blocked until the system switches back to heating mode again. To have the best performance from the heating system it still requires a correct hydraulic balancing of the system.

How to connect

The Smart Radiator Thermostat must be installed on a thermostatic radiator valve. Radiator valves have different interfaces for the radiator thermostat. To fit to the different brands/types of radiator valves the Smart Radiator Thermostat is supplied together with M28/M30 mm adaptors or a RA adaptor. After the adapter is mounted on the radiator, the Smart Radiator Thermostat can be 'clicked' on the adapter.

How to Set

As the Smart Radiator Thermostat can be used for several purposes it is important that during the setup the right settings for the specific system are made.

If you use the Smart Radiator Thermostat at a radiator and you combine it with a room thermostat or not, the system will automatically setup the system and there is no need change any settings.

If you are using the Smart Radiator Thermostat as an underfloor actuator on a manifold, you need to change a setting for the Smart Radiator Thermostat. Either at the touch screen or the PC tool, go to [Room# | Associated outputs | Output for SRT#](#). Here you change the settings for Output role to "Underfloor"

If you want to use the Smart Radiator Thermostat on a radiator in combination with underfloor heating/cooling in the same room you have to enroll a room thermostats/sensor to

the same room as the Smart Radiator Thermostat and have the underfloor output(s) connected to the same room. In this setup the radiator and underfloor system will cooperate to hold the correct temperature in the room.

Settings for the cooperation can be set, either at the touch screen or PC tool by going to menu [Room# | Settings | Radiator cooperation](#).

NOTE: The installation and commissioning of the total heating system is the responsibility of the installer. Once installed and commissioned Wavin does not advise to change the parameter settings unilaterally.

How to Go

The room temperature can be controlled at the Sentio App or at the touch screen of the Central Control Unit. If the Smart Radiator Thermostats are combined with a room thermostat, the room temperature can also be set at the room thermostat.

Once installed the end-user can control the indoor climate comfort in each room.

4.5.4 Dummy room

Why using Sentio & Dummy room

In some buildings there is a mix of radiators and underfloor heating, where the underfloor heating is controlled by Sentio's room thermostats/sensors and thermal actuators, and the radiators are controlled by manual thermostatic radiator heads. In many instances the underfloor heating circuits and the radiators are supplied by different heating suppliers (ITC/pumps) controlled by the Sentio Control Unit. To be able to supply the radiators the control units need to get a heat demand from either a Sentio smart radiator thermostat or a Sentio room thermostat/sensor, If neither of those are present it is possible to use a "Dummy room" to make the heat demand.

Condition of use

It is possible to add one or more 'Dummy rooms' to all preset hardware profiles in Sentio. Be aware of that radiators cannot be used for cooling, but can still be a part of the heating system. When the Sentio system switches from heating to cooling mode, the supply circuit with a dummy room connected, will be blocked until the system switches back to heating mode again.

To get the best performance from the heating system it requires a correct hydraulic balancing of the system.

How to Connect?

A Dummy room has no room thermostats or room sensors, or other inputs connected.

How to Set?

A Dummy room can be created at the LCD touch screen, go to [System | Action add devices/functions | Dummy room](#). Check the Dummy room box and press 'Add' to continue. The Dummy room will now be created, and you can assign it to a supply circuit.

After the Dummy room has been created, it is shown at the Info screen like a standard room. By "opening" the Dummy room settings can be made. Standard the Dummy room is in Comfort mode. The active mode can be changed manually or a time schedule can be made. The selected mode and its associated temperature are used for calculating the desired inlet temperature.

- ⦿ When a Dummy room is in Standby mode the pump and ICT loop will be running but the desired inlet temperature will be lowered.
- ⦿ When a Dummy room is in vacation mode the pump and ICT loop will be running but the desired inlet temperature will be lowered. A Dummy room can be excluded from the Vacation mode.

How to Go?

In the Sentio App it is possible to create a widget for a Dummy room. In the widget it is possible to see/set the current mode and the week schedule.

4.6. Sentio & Heat pump

Why Connect Sentio & Heat pump

The Sentio system offers the option to use a heat pump as heating/cooling source. In principle all kind of heat pumps can be used as long as the communication interface matches with Sentio standards for control.

Connecting a heat pump as heat source is only possible for low temperature heating system (hydronic radiant systems, underfloor heating system) as the maximum temperature is limited. For high temperature systems other heat sources are required.

The Sentio system will be in control of the heat pump to create enough heating/cooling capacity based upon the Sentio zone-control requirements

When connecting a heat pump the interfacing with the Sentio system requires some attention. As the heat pump operates with a certain minimum capacity a buffer should be installed between the heating/cooling circuit(s) and the heat pump.

A heat pump that offers passive cooling option can be used as cooling source for the underfloor heating system. To make use of this option the Sentio profile dedicated for this needs to be selected during SET phase.

Cooling via an underfloor system requires certain attention and has limitations. First of all, it is less efficient as heating as the temperature differences between the inlet cooling temperature and the return temperature are relatively small compared to heating. Furthermore, the inlet cooling water temperature is limited by the dewpoint (based upon room temperature and relative humidity).

The Sentio system offers various ways of switching between heating and cooling.

- 1) Manual changeover done by the user via a physical switch when the season changes.
- 2) Manual changeover using a software switch via the LCD touch screen or mobile APP.
- 3) Automatic changeover based on outdoor temperature the past few days.
- 4) Manual changeover from a building management system via Modbus. (see Modbus guide in the appendix).

Conditions of Use

When using the heating/cooling option it is important to understand that an underfloor heating/cooling system reacts slow. This implies that switching the system from heating to cooling and vice versa requires a certain responding time. Also, the heat pump shall be able to stabilize after switching. Therefore, the software of this profile is designed in such a way that the frequency of switching is limited based upon the specifications of the heat pump supplier.

In general, Wavin advices not to switch between heating/cooling several times per day as the response time will be slow.

How to Connect

The communication between the heat pump and the Sentio controller can be realized using the two voltage free relays (VFR) and the analog signal (AO/GN) mainly. Development is still ongoing to expand and improve the connection to heat pumps.

When using a heat pump it is required to make use of an outdoor temperature sensor (beside the outdoor temperature sensor of the heat pump) in order to optimize the system. Such an outdoor temperature sensor shall be installed as per the description in the CONNECT chapter.

Sentio has an option for an external error contact. A dry switch from the heat pump can signal it has an error, Sentio will show this in the touch screen and Sentio APP to indicate there is an error on the heat pump.

How to Set

The setting of the correct profile to communicate with the heat pump can be made via the touch screen. By default VFR1 will signal demand and VFR2 will signal cooling mode, these can be given another function to fit your heat pump connection. To change the VFR outputs use the touch screen to go to [System | Installer Settings | Hardware Profile | configure non-profile in/ outputs | VFR | Activation condition](#) and set the function that fits the heat pump connection requirement.

For Sentio in combination with a heat pump the right profile will have to be set. For the list of profiles see paragraph 4.2.

How to Go

The Sentio system can be controlled via the room thermostats in each room, via the Sentio app and if required via the touch screen. For this profile we strongly recommend including the touch screen within the Sentio system as it will give more freedom for the user to monitor the system.

NOTE: Not all heat pumps are yet compatible with the Sentio system. Therefore a check with the heat pump supplier is required or Wavin shall be contacted to check this.

The installation and commissioning of the Nibe heat pump is the responsibility of the installer. In most cases Nibe will install and commission the heat pump themselves. Contact Nibe (www.nibe.com) for this.

For the Nibe heat pump a direct analogue signal will be used in order to control heating & cooling demand.

Connection on the Sentio CCU module is the 0-10V connection terminals coded A0 - GN:

Below the connection schema:

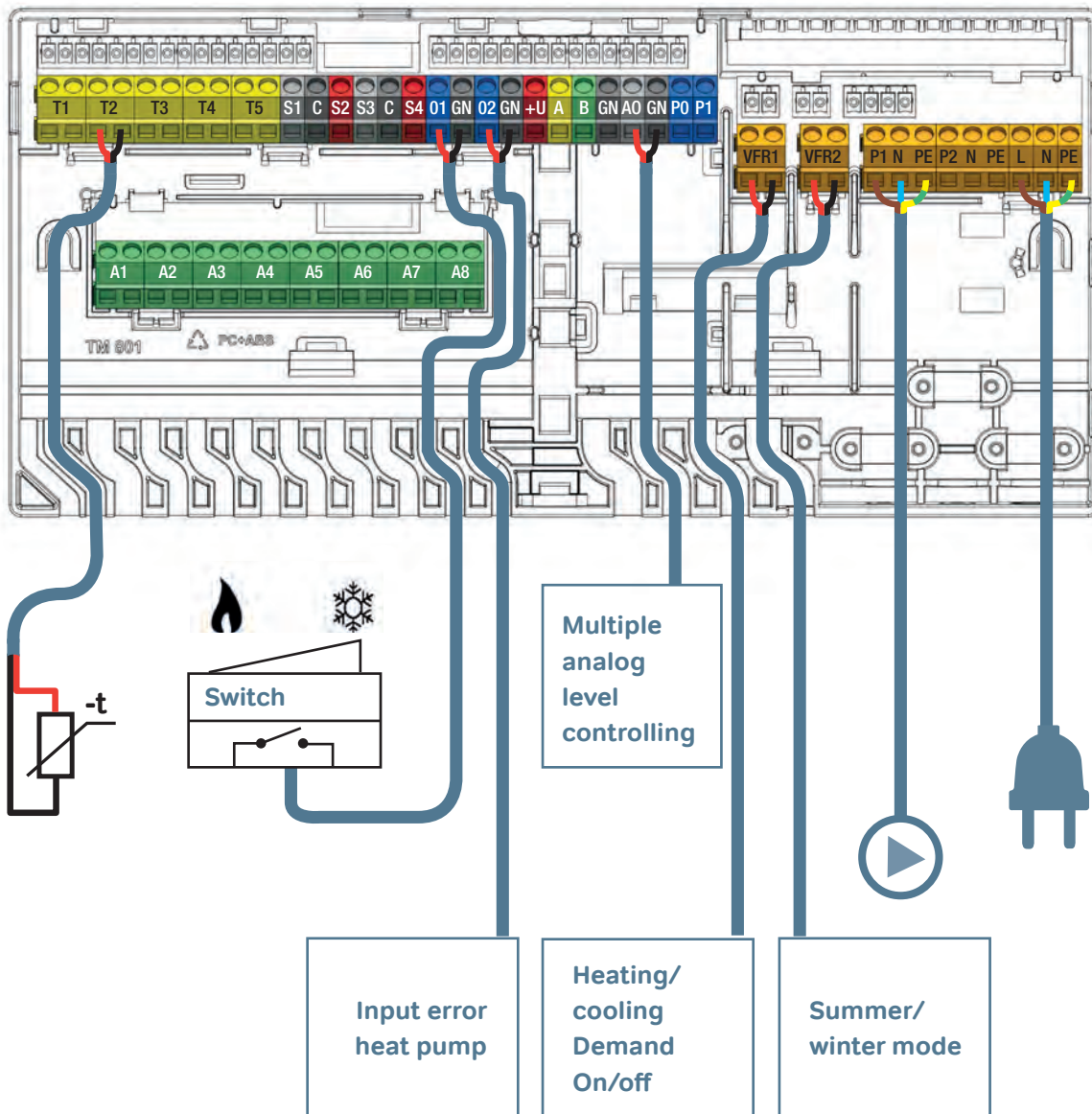

4.7. Sentio & District Heating

4.7.1. Sentio & district heating

Why Connect Sentio & District Heating

The Sentio system enables the use of so called Inlet Temperature Controller (ITC) functionality that enables it to be used for district heating systems. By using this ITC functionality it is possible to comply to the requirements when using district heating as heating source for underfloor heating. It contributes to a very efficient way of heating.

For district heating it is typical that relative hot water (e.g. 80°C) is supplied to residential buildings and used for a) hot tap water and b) underfloor heating.

Sentio can be used in combination with district heating for underfloor heating applications as the ITC functionality controls the inlet and return temperature of the mixing unit and ensures that the inlet temperature is not above the pre-set maximum and that the return water temperature is below a pre-set maximum.

ITC embedded in the Sentio CCU controls a linear servo motor which is installed in the mixing unit (instead of the common used manual room thermostat) of an underfloor heating system. The ITC regulates hot water supply temperature supplied by e.g. district heating system.

Depending on the outdoor temperature, selected heat curve and the water temperature in the return pipe, the central control unit controls the servo valve to achieve the desired temperature.

The ITC can also be used instead of a manual room thermostat in order to automatically control the inlet and return temperature based upon the required heat demand.

As the Sentio system can handle two mixing units at the same time it is also able to deal with two ITC groups simultaneously.

Conditions of Use

When applying the ITC functionality it is mandatory to include an external outdoor temperature sensor and an inlet & return temperature sensor on the mixing unit.

Within the settings for the ICT loop via the PC/touchscreen the parameter settings of the ITC shall be checked and adjusted only when necessary.

At the moment 2 ITC's are used the outputs/rooms associated to each ITC loop shall be defined.

How to Connect

The connection between the district heating supply and return pipes and the mixing unit shall be made by the installer. The ITC servo motor is connected to the mixing unit at the same position as the manual room thermostat. In the Sentio article list this servo motor is listed.

Connection of the servo motor(s) with the CCU is via the ITC terminal connections as explained in the CONNECT part of this manual, please see 3.3.

The inlet temperature sensor is mounted on the inlet of the brass/RVS part just before the inlet of the manifold unit and connected to the CCU as per the information from the CONNECT part. The return temperature sensor is connected to the brass/RVS return side of the return manifold and wired to the CCU as per the CONNECT part of this manual.

Wavin has an existing portfolio of Heat interface Units available for District & Block Heating known as 'Calefa'. These units can be controlled directly by Sentio. For more info about this Calefa product please visit our website.

How to Set

The ITC settings can be checked and adjusted via the touch screen or the PC tool for profiles including an ITC.

Under [System | Functions | Inlet Temperature Control | ITC Settings](#) the settings can be found. If there is an error after connecting the ITC check if there is an inlet temperature sensor connected. For instructions on how to connect an inlet temperature sensor please have a look at paragraph “3.3 Accessories”. If there is still an error, make sure the corrected servo type is selected by going to [System | Installer settings | Hardware profile | Configure required inputs and output | Servos | ITC servo](#). It must be set to “3-point”.

For Sentio in combination with a district heating the right profile will have to be set. For the list of profiles see paragraph 4.2.

An important aspect is to ensure that each room has its own room thermostat/sensor that is connected (wired or wireless) with the central control unit of the Sentio system.

Selection of profile and parameter settings to be done by the installer. Adjustment of the settings is possible via the touch screen (optionally available for the end-user) by the installer. It is important to notice that it is crucial that the underfloor heating zones per room are correctly enrolled/connected to the room thermostat/sensor in that room. If this is not the case heat-demand in a certain room can result in heating another room. Therefore during the commissioning this aspect needs to be checked carefully before the system is handed over to the end-user.

NOTE: The installation and commissioning of the underfloor cooling system is the responsibility of the installer. Once installed and commissioned Wavin does not advise to change the parameter settings unilaterally.

How to Go

The Sentio system can be controlled via the room thermostats/sensors in each room, via the Sentio app and if required via the touch screen. Once installed the end-user can control the indoor climate comfort in each room.

4.7.2. Sentio & serial supplying circuits

Why using serial supplying circuits

The position of heating distributors in a heating system are not always parallel to each other. In some cases a servo will control the heat supply to the complete system, in these cases the Inlet Temperature Control (ITC) function can be used. This controls the inlet temperature based on outdoor temperature and heating/cooling demand in connected rooms.

However, when the ITC is connected as main supply valve the ITC servo of the underfloor manual needs to forward its heating/cooling demand. In systems like this its common that there is a separate flow towards high temperature heating circuits in the system (e.g radiators). The supply ITC will calculate the needed heat for the both systems in the most efficient way. For example if there is no demand from the high temperature circuit, it will lower the main supply temperature to be enough for the just the underfloor heating part of the system.

The minimum demand of the second ITC circuit will have priority over the return temperature limiter of ITC circuit 1. The same can be done for a heating/cooling circuit (HCC) without ITC when available in the profile.

How to connect

Make sure the two servo's are connected in series. The first ITC servo will be connected on the left connection of the CCU and the second ITC servo on the second connection. The order of the servo's does not matter, but it needs to be clear which is which. When setting the order can be turned around.

How to set

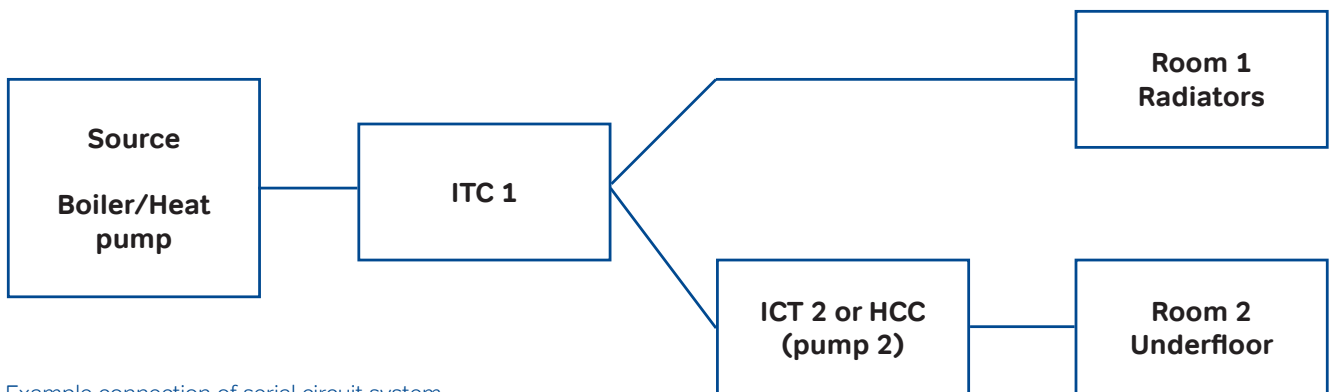

Example connection of serial circuit system.

A profile with two ITC (e.g 1.3.2, 2.2.2 or 4.1.4) is needed for this function. Find the right profile that fits your specific system and set it via the touch screen by going to [System | Installer Settings | Hardware profile | Change profile](#).

The ITC order can be assigned in the touch screen by going to [System | Functions | ITC | Main Supplier](#)

Here the ITC can be assigned to another ITC or heating circuit if available or the heating/cooling source. By default all heating/cooling circuits are assigned to the heating/cooling source directly. When changing the sources stay well aware of your system design.

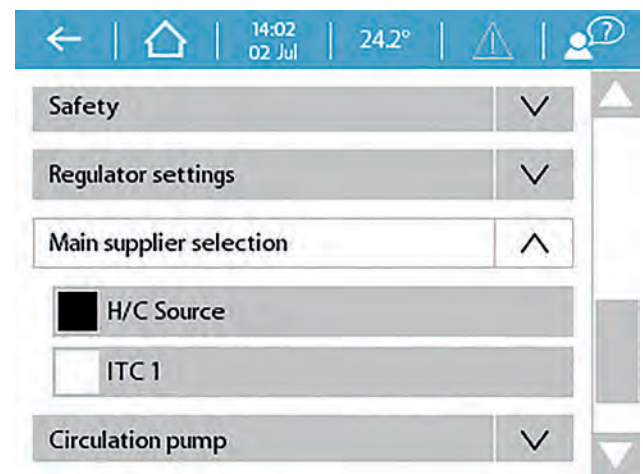

4.8. Sentio & Boiler

Why Connect Sentio & Boiler

The Sentio system offers the option to connect directly to a boiler to support heating. Connecting to a boiler will be the most common application for a hydronic heating system. In general systems like this can supply both high temperature heating systems like radiators and low temperature systems like underfloor heating. Using the Sentio system the simple on/off heating boiler will be transformed into a smart zone-controlled system which only heats the rooms where heating is required. When using a modulating boiler, the Sentio can control it efficiently via a 0-10V analog signal, calculating the exact heat needed to heat all rooms that require heating. Sentio provides a basic outdoor temperature compensation when an outdoor temperature sensor is connected, this will block heating when outdoor temperatures reach a temperature where heating should not be active anymore.

Conditions of Use

When using the Sentio system to control a boiler it is important that the boiler settings are set for hydronic underfloor heating systems. In general, the inlet water temperature for the mixing unit must be reduced to about $<50^{\circ}\text{C}$ in order to optimize energy usage, but also to prevent a too high water temperature in the hydronic heating system that might damage the system or the floor.

How to Connect

The communication between the boiler and the Sentio controller can be realized via the voltage free relay (VFR1) or, in case of a modulating boiler, via the analog output. Most manifolds already have a way to limit the inlet temperature, as an extra precaution an inlet sensor can be connected (one for each manifold) to close outputs when the inlet temperature gets too high.

How to Set

The default profile 1.1 already works with a boiler. In more specific systems with a boiler another profile must be set via the touch screen or via the PC tool (software can be downloaded via the website and the Sentio connection cable can be ordered from Wavin). With all components connected and enrolled to the system not much has to be set unless two separate manifolds are used, in which case the rooms will have to be re-assigned to the second circuit. The basic settings provided by Sentio will work fine for most situations. In rooms with both underfloor heating and radiators controlled by Smart Radiator Thermostats “radiator cooperation” can be set, this will make sure the two systems are used in a smart and efficient way.

For Sentio in combination with a boiler the right profile will have to be set. For the list of profiles see paragraph 4.2.

How to Go

The Sentio system can be controlled via the room thermostats in each room, via the mobile Sentio APP and if required via the touch screen display. For this profile the touch screen display is a helpful tool to within the Sentio system as it will give more freedom for the user to monitor the system.

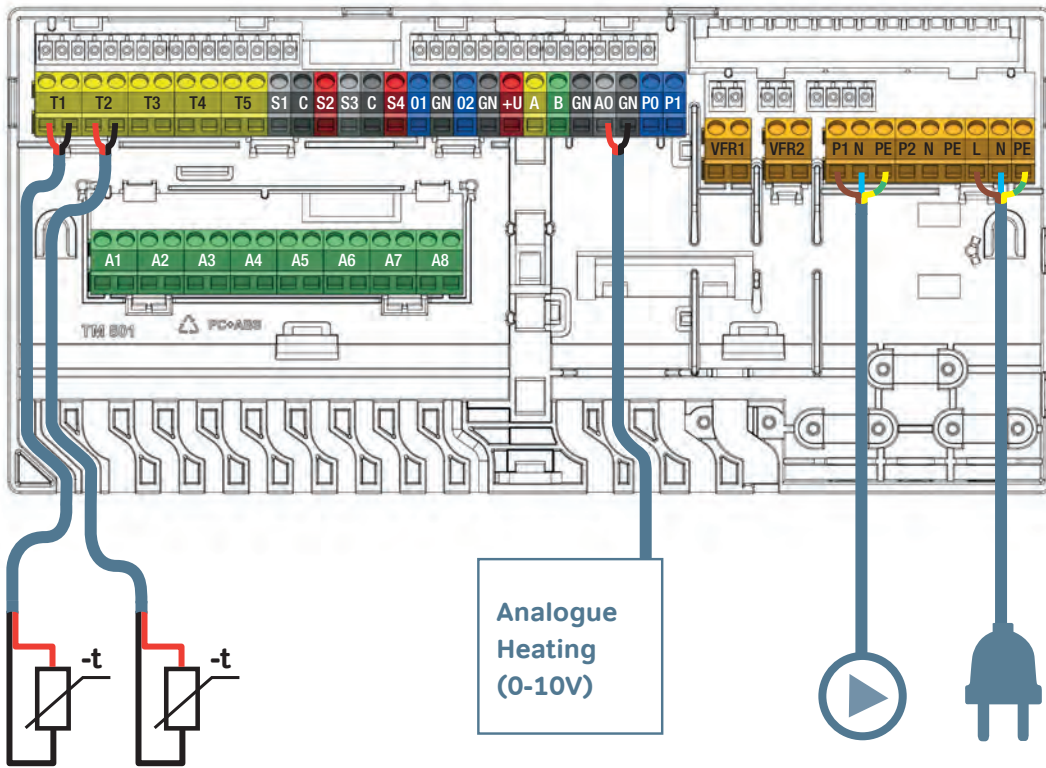

Connections Condensing Boiler.

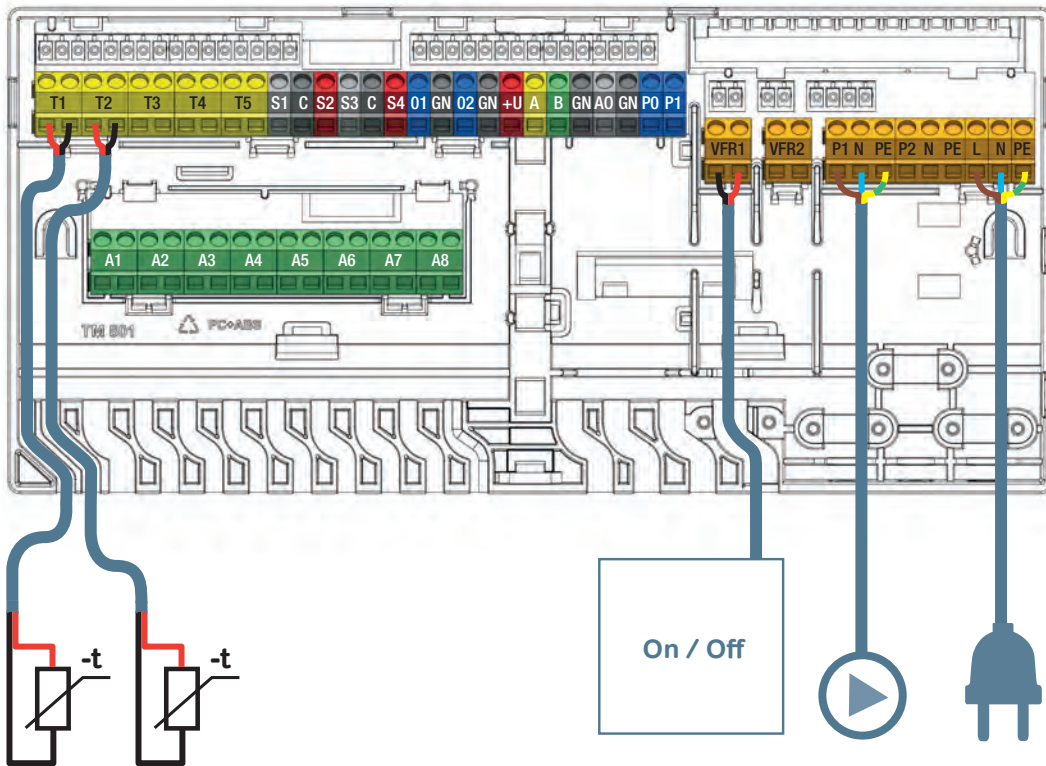

T1 optional

Boiler ON/OFF.

4.9. Sentio & Humidity control

Why using Humidity Control as an Application

In situations where humidity and temperatures are often high a dehumidifier can be added to the system. This unit will extract water from the air when the relative humidity gets above a certain set-point. Lowering the humidity contributes to the thermal comfort as the temperature is experienced as lower than the actual temperature.

Not every room has a dehumidifier, this shouldn't be necessary to lower the humidity. It is possible to add multiple (attached) rooms to the same dehumidifier, because the humidity can equalize between rooms, one dehumidifier might be enough to lower the humidity in multiple rooms or indirectly lower the humidity of a certain room. The dehumidifier can be set to switch ON if relative humidity is too high in one of the connected rooms, or only if all connected rooms have reached the humidity setpoint.

Optimize cooling by adding humidity control to your system as the risk of condensation is reduced. If a servo (ITC) is installed on the mixing valve, the Sentio system will use the dehumidifier and ITC servo to optimize cooling even further. This is done by avoiding reaching the dewpoint by lowering the relative humidity of the room and controlling the inlet temperature to the lowest temperature possible without reaching the dewpoint and the chance of condensation.

Conditions of Use

The profiles for humidity control are based on the following conditions:

- One or two Voltage Free Relay extension modules (EU-VFR) are connected to the CCU.
- Up to four dehumidifier units can be set to the system, for multiple units per room.
- The dehumidifier unit can be set to the same circuit as the underfloor heating/cooling, a separate circuit or directly to the heating/cooling source.
- The dehumidifier water supply, if connected, will be connect to the circuit, a separate circuit, the source or outside the system.
- If the dehumidifiers are not connected to one of the main circuits an extra pump can be connected to a VFR and set for the dryers.

- The system accepts a maximum of 16 thermo-actuators. Each actuator connected for the units water supply will count as one of those.
- A dehumidifier system requires maintenance. Maintenance requirements, like filter inspection and change, will have to be followed as specified by the dehumidifier unit manufacturer.
- Efficient placing dehumidifier units.

How to Connect

The voltage free relays (VFR) on the extension unit (EU-VFR) will function as an ON/OFF switch for the dehumidifier connected, a dehumidifier unit that can be controlled in this way has to be connected. To make setting the system easier a pre-set layout can be loaded for the EU-VFR, in preparation for this the dehumidifiers should be connected in a predefined pattern as mentioned in paragraph 3.6. Wavin can offer the P300, S300, PC300 or S300 which are perfectly compatible with the Sentio and are easily installed and connected.

With the dehumidifier's water supply connected directly on the heating/cooling source it is strongly advised to add a pipe sensor on the supply line on the source (terminal T1), the source temperature will be taken for the heating/cooling circuit if no inlet temperature is available. To control the supply to the dehumidifier an external actuator can be connected to control a valve on the supply line.

The PWM input (pin PI) can be connected to an error signal from the dehumidifier unit. To do this, PI has to be switched by a dry contact (no potential) or by an external Open Collector output (switching to ground). Maximum allowed frequency is 100 Hz, input bias voltage 10 V DC. With the dehumidifier's water supply connected directly on the heating/cooling source it is strongly advised to add a pipe sensor on the supply pipe on the source (terminal T1), the source temperature will be taken for the heating/cooling circuit if no inlet temperature is available. To control the supply to the dehumidifier an external actuator can be connected to control a valve on the supply pipe.

How to Set

After enrolling the dehumidifier unit(s) as mentioned in the 'SET' part of the manual, assign room(s) to the unit, these rooms should have at least have one room thermostat/sensor connected (wired or wireless). If the connected room is not allowed to cool. for example a bathroom, set in the touch screen's room settings 'allow cooling' to OFF. In the touch screen or PC commissioning tool set the correct connections of your system as mentioned above in the "Conditions of use" part.

For further settings for Sentio in combination with humidity control, see profile descriptions for profiles 4.1.x in paragraph 5.1.

How to Go

The Sentio system will control the humidity automatically with the default or set values, this includes the optimal cooling by lowering the humidity and the dewpoint protection. In situations where the relative humidity limit has to be changes the end-user can change the relative humidity set-point in the Sentio mobile app.

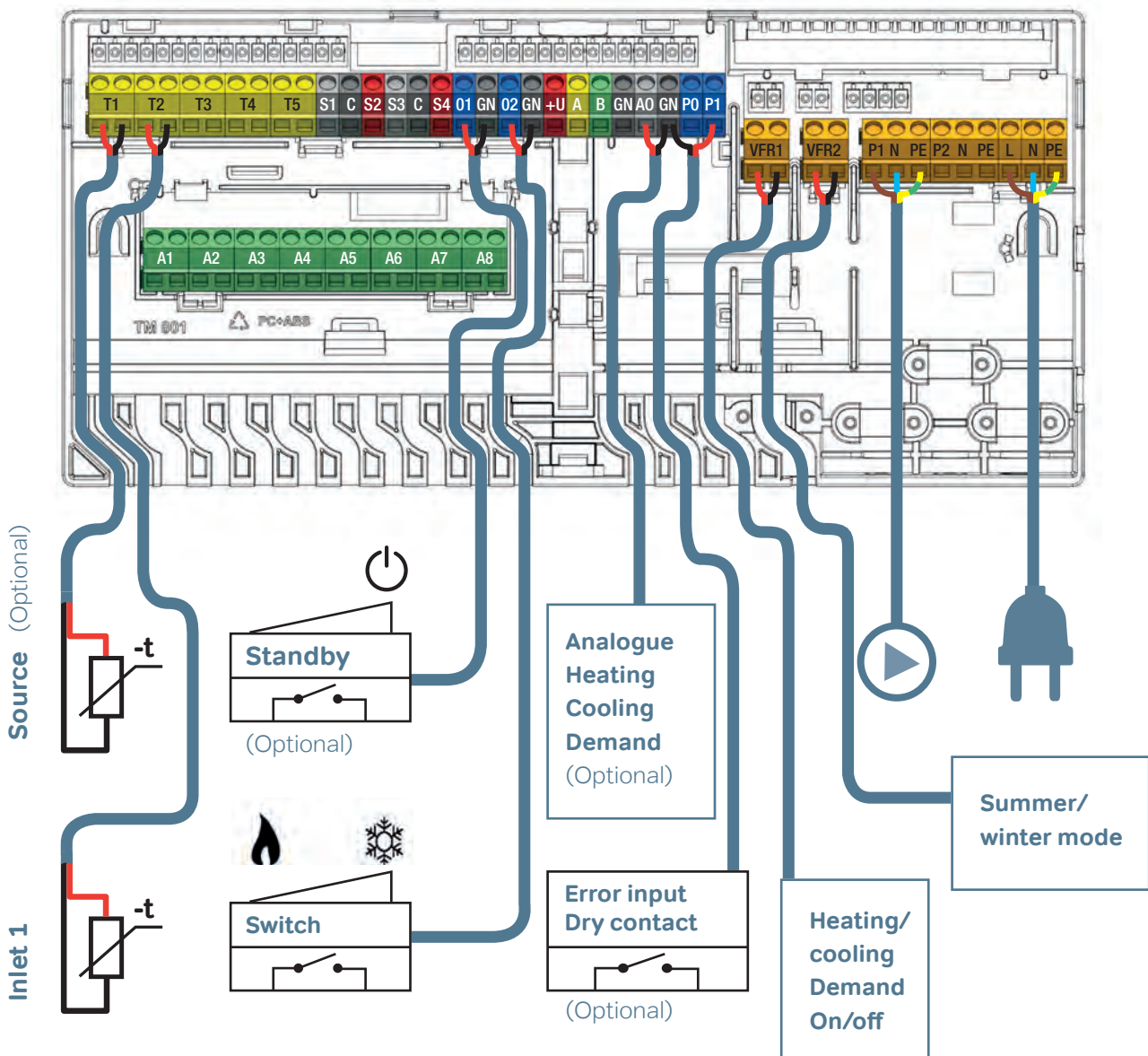

4.10. Sentio & Controlled Mechanical Ventilation

Why using Sentio & Ventilation

Modern houses are built well-insulated and air tight, to minimize energy consumption for heating and cooling. Ventilation is provided mechanically, either by means of extract fans and supply vents, or by means of balanced ventilation systems. Airtightness of dwellings means ventilation must be controlled.

Sentio offers an opportunity to combine heating and ventilation. If the heating is active, passive cooling by ventilation is prevented for. Ventilation and heating both use the same room information of temperature and humidity.

The indoor climate can be controlled via a single APP, the Sentio APP can be used for both ventilation control and temperature control as before. The ventilation widget only is available when a Ventiza unit is connected.

Conditions of Use

Sentio works with Wavin branded mechanical ventilation units equipped with Modbus. To control ventilation, Sentio has to be set to Modbus Master using the touch screen commissioning tool.



The Modbus connection on the Central Control Unit (CCU) is not available to be integrated as a Modbus Slave device to a building management system.

How to Connect

Using the touch screen set Sentio's Modbus mode to 'Master' in the Modbus settings. The CCU will restart and load Modbus Master protocol for port A. Make sure the Modbus settings for the CCU and the ventilation unit are set the same.

When the CCU has restarted the Modbus connection with the ventilation unit can be made using RS485 connector from Port A on the CCU to the Modbus port on the ventilation unit as specified in its instructions.

The ventilation unit can be enrolled to Sentio as instructed in the CONNECT part of this manual. When adding the device, you can select the connected unit, when enrolled Sentio will try to establish a connection and load in all the needed parameters from the ventilation.

How to Set

The controlled mechanical ventilation settings specific to the unit will still have to be set in the ventilation unit itself based on the building and local regulations with the installation manual of the product.

When the ventilation unit has established a connection and is successfully enrolled to Sentio rooms can be assigned, based on these room's relative humidity level the ventilation boost mode can be triggered. So rooms where excessive humidity can occur (e.g. bathroom and kitchen) can be connected in order to automatically trigger the boost mode. The ventilation device settings can be found in the touch screen or PC tool by going to [System | Functions | Ventilation](#)

The humidity setpoint can be found in the touch screen or PC by going to [Info | Room | Settings | Humidity Control](#) when the room as been assigned to the ventilation unit.

In Sentio there are multiple ventilation modes that can be used to control ventilation: Unoccupied, Economy, Comfort, Boost and Stop mode. Stop mode is only available based on country specific regulations. Air flow for the ventilation modes can be set using the touch screen or PC tool by going to [Systems | Functions | Ventilation | Ventilation mode settings](#). The ventilation modes should be set according to the building design and local law.

A time scheduler can be set for the ventilation via the touch screen or the Sentio APP. By default comfort mode is used, unoccupied hours or busy hours can be manually inserted as intervals. It's important to have enough ventilation when people are present in the building, especially at night. Healthy environment requires 40m³/h of ventilation for each person. Therefore its advised to use comfort mode as default besides the exception intervals.

How to Go

To control ventilation a special widget is available in the Sentio APP. Here the user can set schedules or a temporary ventilation mode. A temporary ventilation mode will override the schedule until the next change in the schedule, similar to the heating schedule.

Boost mode will activate automatically when relative humidity in the connected rooms gets too high. It will deactivate automatically if the relative humidity is at an acceptable level, or if boost cannot reduce the relative humidity due to outdoor conditions. The boost mode can also be activated from the Sentio APP.

The filter lifetime will notify the end-user in the Sentio APP when the filter needs to be replaced. The specific filter needed depends on the mechanical ventilation unit type. For the right filter, please check the manual of the device.

When the filter is replaced the filter time has to be reset. This can be done in the APP or in the touch screen by going to [System | Functions | Ventilation | Air Filter Management](#) and clicking on the 'replace filter' button. This will pause the ventilation unit in order for the filter to be replaced.

If filter replacement isn't performed in time, the energy consumption will increase and the air quality will decrease. Mould growth may occur at the filter surface if filter replacement is postponed for too long.



For the right filter, please check the manual of the device or contact a ventilation installer to replace the filter according to the device's instructions.

5. Profiles description

5.1. Profile descriptions

Profile 1.0 - Underfloor Heating Together with District Heating

Profile 1.0 is the simplest profile and used for a standard under floor heating systems without Inlet Temperature Control. If more than 8 outputs are required, an extension unit (EU-A) should be added to the system

- It is possible to control up to 2 standard pumps, On/Off
- Both wired and wireless room thermostats and sensors can be used
- It is possible to add Smart Radiator Thermostats
- By connecting one (two) pipe sensor to the CCU, it is possible to protect the system against a too high inlet temperature. This can be done separately for the two different manifolds
- It is optional to install the Sentio touch screen.

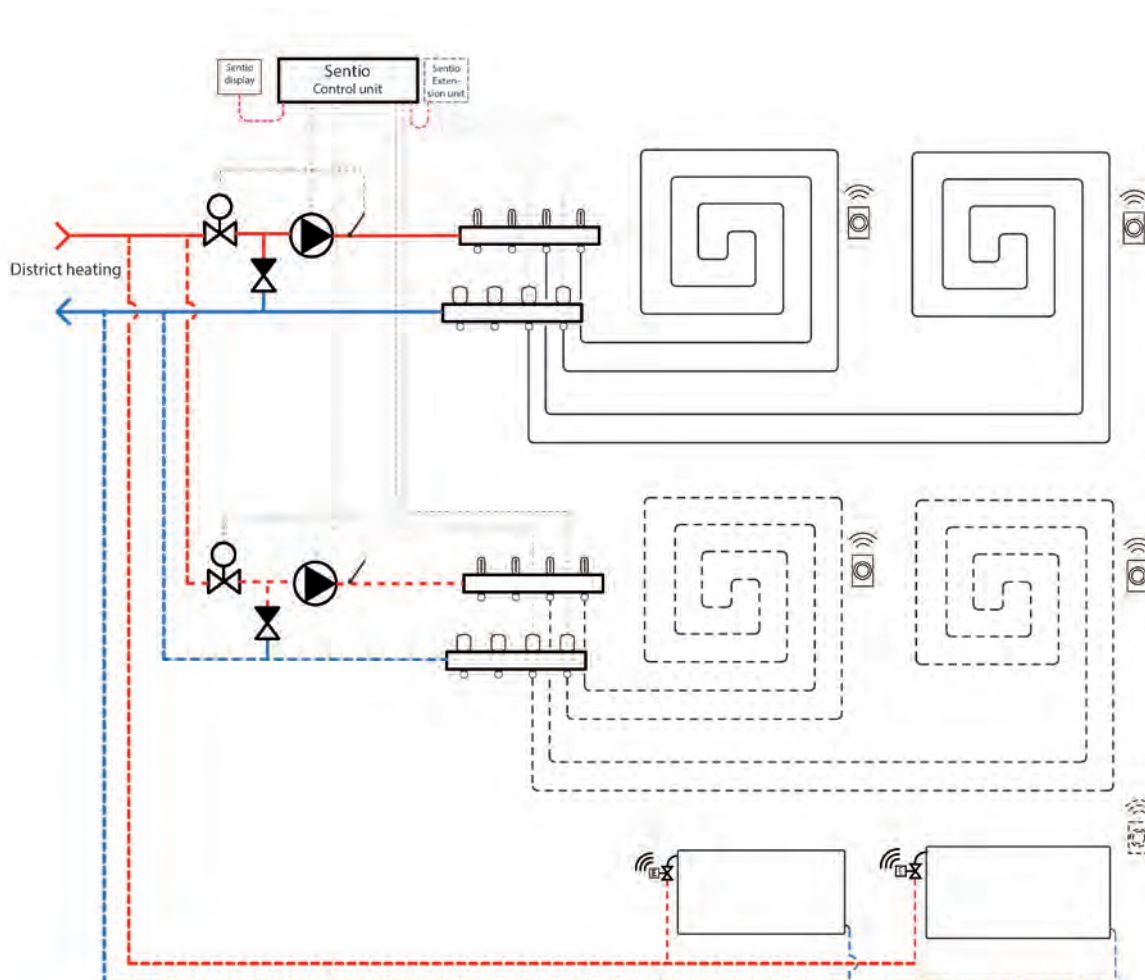

Wiring for profile 1.0

All the wiring should be done according to the description in the CONNECT chapter of this manual, please see paragraph 3.4.

Setup of Profile 1.0

To be able to set/adjust the settings for the Sentio system you need either the Sentio touch screen or the Sentio connection cable for PC.

In order to use profile 1.0, use the touch screen or the PC tool via the connection cable and follow the steps below:

- Change profile in the touch screen or the PC tool by going to the menu [System | Installer settings | Hardware profile | Change profile](#), select: "1.0 District heating".

The system will restart and load the new profile.

If you have two manifolds for underfloor heating and/or have Smart Radiator Thermostat's connected to the system the correct supply circuit will have to be set. By default, both the underfloor outputs and radiators are assigned to Heating/Cooling circuit 1 (pump 1). In rooms with both underfloor heating and radiators, the two can have the same or different supply circuits, re-assign the underfloor and radiators to fit your system. When two underfloor circuits are being used or the supply for radiators is directly connected to the heating source, radiators will have to be assigned to H/C source. To re-assign outputs to a different supply circuit they will first need to be removed from the default circuit.

- Assign the room's outputs in the touch screen or PC tool by going to menu [System | Functions | Heating circuit 1\(2\) | Room assignment for this circuit](#) and select the rooms you want to control the pump.
- Assign radiators to the H/C source in the touch screen or PC tool by going to menu [System | Functions | H/C source | Room assignment](#) and select the room's radiators that are connected directly to the heating source.

Personal preference settings of profile 1.0

The High Temperature Cut Off feature is disabled by default. If the inlet temperature gets too high, heating will be blocked to protect the circuit.

- Change the High Temperature Cut Off feature in the touch screen or the PC-tool by going to the menu [System | Functions | Heating circuit 1\(2\) | Cut-Off temperatures](#). Enable the High Temperature Cut-Off, set the desired Cut-Off temperature and the delay, expressed in K.s (Kelvin/second).

If you have more than one manifold, you must set the High Temperature Cut-Off for both manifolds.

By default, the start signal to the pump(s) is delayed by 5 minutes, to allow the thermal actuators to open, before the pump starts. You can shorten or lengthen this delay.

- Change the pump's delay in the touch screen or the PC-tool by going to the menu [System | Installer settings | Hardware profile | Configure required inputs and outputs | Relays | Pump 1\(2\)](#) and change the "Start delay" value to the value you need.

If you have more than one pump, you must set the "Start delay" for both pumps.

By default, the stop signal to the pump(s) is delayed by 3 minutes, to allow the thermal actuator to close, before the pump stops. You can shorten or lengthen this delay.

- Change the pump's delay in the touch screen or the PC-tool by going to the menu [System | Installer settings | Hardware profile | Configure required inputs and outputs | Relays | Pump 1\(2\)](#) and change the "stop delay" value to the value you need.

If you have more than one pump, you must set the "Stop delay" for both pumps.

Profile 1.1 - Underfloor Heating Together with a Boiler / Heat pump (On/Off)

Profile 1.1 is the default profile used for a standard under floor heating systems without Inlet Temperature Control and with the possibility to give a signal to a boiler/heat pump if there is a heat demand.

- If more than 8 outputs are required, an extension unit (EU-A) should be added to the system.
- It is possible to control up to two standard pumps, On/Off.
- Both wired and wireless room thermostats and sensor(s) can be used.
- It is possible to add Smart Radiator Thermostats
- By connecting temperature sensors to the manifold, it is possible to protect the circuit against a too high inlet temperature. This can be done separately for the two different manifolds
- It is optional to install the Sentio touch screen.

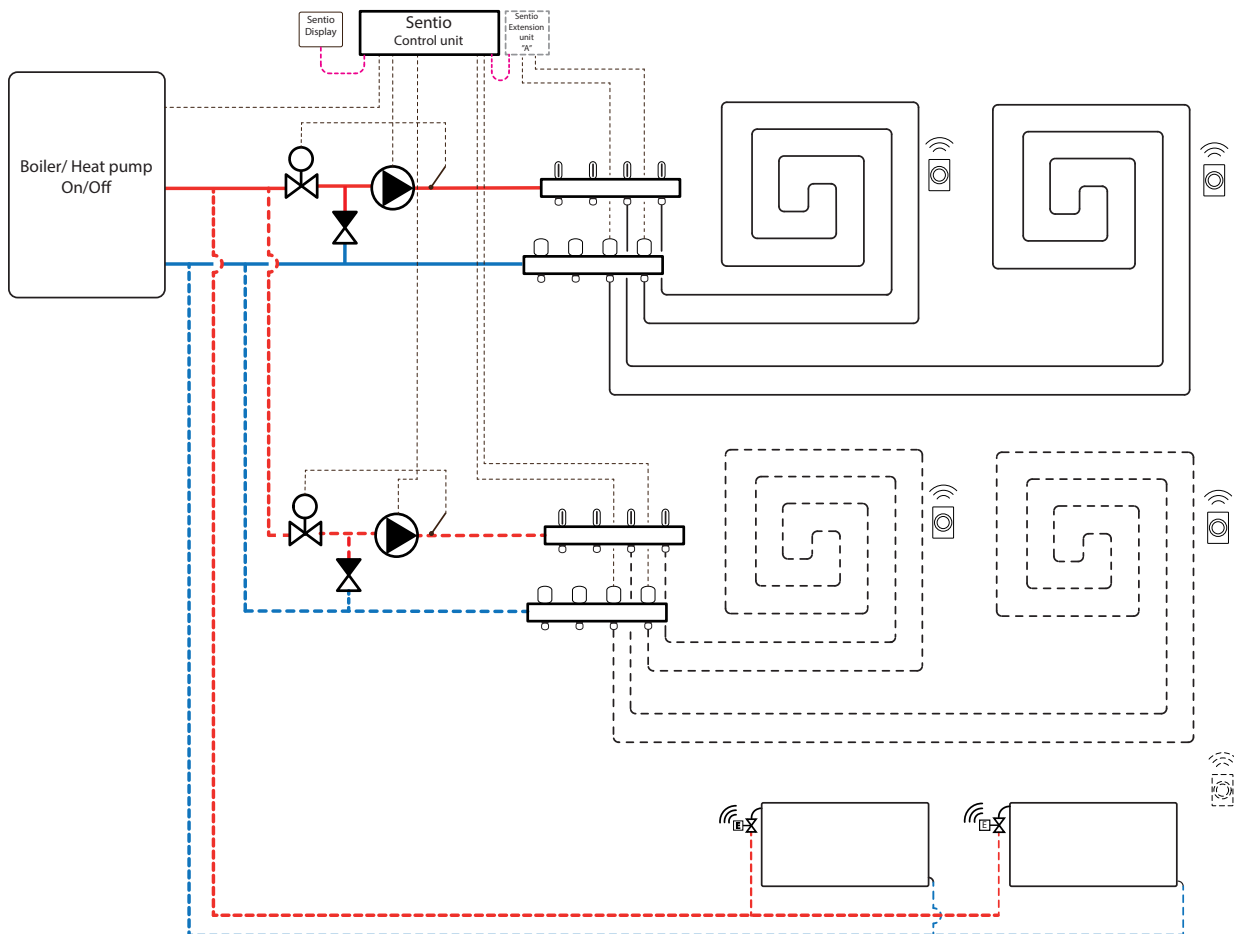

Wiring for profile 1.1

All the wiring shall be done according the drawing in paragraph 4.8.

Setup of Profile 1.1

To be able to set/adjust the settings for the Sentio system you need either the Sentio touch screen or the Sentio connection cable for PC.

If you have two manifolds for underfloor heating and/or have Smart Radiator Thermostat's connected to the system the correct supply circuit will have to be set. By default, all underfloor outputs will be connected to the heating/cooling circuit 1 (pump 1) and all Smart Radiator Thermostats to heating/cooling circuit 2 (pump 2).

In rooms with both underfloor heating and radiators, the two can have the same or different supply circuits, re-assign the underfloor and radiators to fit your system. When two underfloor circuits are being used or the supply for radiators is directly connected to the heating source, radiators will have to be assigned to H/C source.

- Assign the room's outputs in the touch screen or PC tool by going to menu [System](#) | [Functions](#) | [Heating circuit 1\(2\)](#) | [Room assignment for this circuit](#) and select the rooms you want to control the pump.
- Assign radiators to the H/C source in the touch screen or PC tool by going to menu [System](#) | [Functions](#) | [H/C source](#) | [Room assignment](#) and select the room's radiators that are connected directly to the heating source.

Personal preference settings of profile 1.1

When using outdoor thermometer on input T1 the sensor input must be selected as outdoor source in the settings. When Sentio's wired or wireless outdoor temperature sensor is enrolled to the system, it will be selected automatically.

- Set the outdoor thermometer in the touch screen or in the PC tool by going to the menu [System](#) | [Installer settings](#) | [Hardware profile](#) | [Set outdoor temperature source](#).

The High Temperature Cut Off feature is disabled by default. If the inlet temperature gets too high, heating will be blocked to protect the circuit.

- Change the High Temperature Cut Off feature in the touch screen or the PC-tool by going to the menu [System](#) | [Functions](#) | [Heating circuit 1\(2\)](#) | [Cut-Off temperatures](#). Enable the High Temperature Cut-Off, set the desired Cut-Off temperature and the delay, expressed in K.s (Kelvin/second).

If you have more than one manifold, you must set the High Temperature Cut-Off for both manifolds.

When there is a heat demand to the boiler/Heat pump, the boiler relay will be "closed". If you need the relay to be "open" during a heat demand the settings can be changed:

- Invert the heat demand relay in the touch screen or the PC tool by going to the menu [System](#) | [Installer settings](#) | [Hardware profile](#) | [Configure required inputs and output](#) | [Relays](#) | [Voltage free relays](#) | [Boiler VFR](#) and change the "Not inverted value" to "Inverted". Now the relay will be "Open" when there is a heat demand.

By default, the start signal to the boiler is delayed by 5 minutes, to allow the thermal actuators to open, before the boiler starts. You can shorten or lengthen this delay.

- Change the boiler start delay the touch screen or in the PC tool by going to the menu [System](#) | [Installer settings](#) | [Hardware profile](#) | [Configure required inputs and output](#) | [Voltage free relays](#) | [Boiler VFR](#) and change the "Start delay" value to the value you need.

By default, the start signal to the pump/s is delayed by 5 minutes, to allow the thermal actuators to open, before the pump starts. If you need either to shorten or lengthen this delay. Please follow the steps below to do the changes:

- Change the pumps start delay in the touch screen or the PC tool by going to the menu [System](#) | [Installer settings](#) | [Hardware profile](#) | [Configure required inputs and output](#) | [Relays](#) | [Pump 1\(2\)](#) and change the "Start delay" value to the desired value.

If you have more than one pump, you must set the "Start delay" for both pumps.

By default, the stop signal to the pump(s) is delayed by 3 minutes, to allow the thermal actuators to close, before the pump stops. If you need either to shorten or lengthen this delay. Please follow the steps below to do the changes:

- Change the pumps stop delay in the touch screen or the PC tool by going to the menu [System](#) | [Installer settings](#) | [Hardware profile](#) | [Configure required inputs and output](#) | [Relays](#) | [Pump 1\(2\)](#) and change the "stop delay" value to the desired value.

If you have more than one pump, you must set the "Stop delay" for both pumps.

Profile 1.2 - Underfloor Heating Together with a Condensing Boiler (0-10V Control)

Profile 1.2 is a profile used for a standard under floor heating systems without Inlet Temperature Control and with the possibility to give an analog (0-10V) signal to a boiler/heat pump, reflecting the desired set temperature.

- If more than 8 outputs are required, an extension unit (EU-A) should be added to the system.
- It is possible to control up to 2 standard pumps, On/Off.
- Both wired and wireless room thermostats and sensors can be used.
- It is possible to add Smart Radiator Thermostats
- By connecting temperature sensors to the manifold it is possible to protect the circuit against a too high inlet temperature. This can be done separately for the two different manifolds.

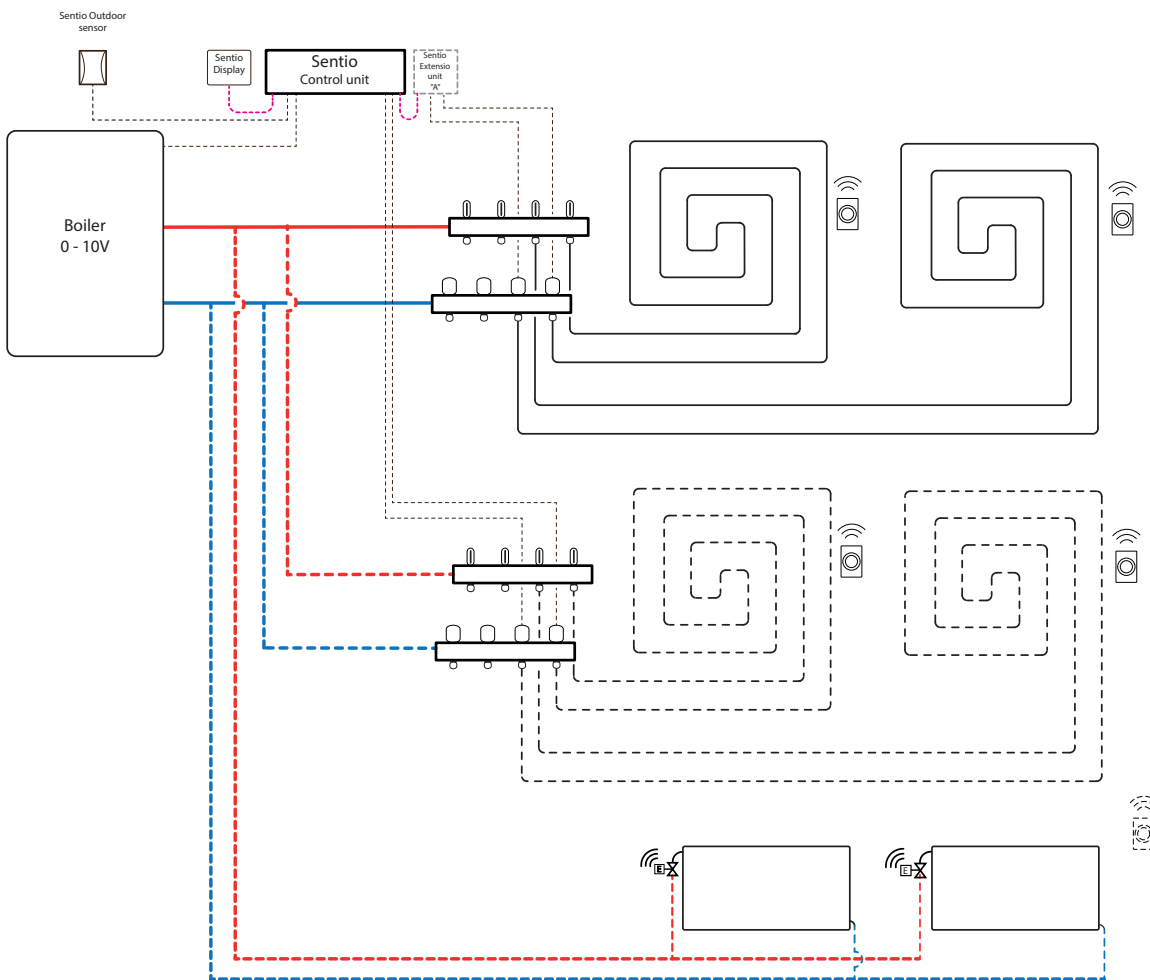

Wiring for profile 1.2

All the wiring should be done according to the drawing in paragraph 4.8.

Setup of Profile 1.2

To be able to set/adjust the settings for the Sentio system you need either the Sentio touch screen or the Sentio connection cable for PC.

In order to use profile 1.2, use the touch screen or the PC tool via the connection cable and follow the steps below:

- Change profile in the touch screen or the PC tool by going to the menu [System | Installer settings | Hardware profile | Change profile](#), select: 1.2 Condensing boiler 0-10V. The system will restart and load profile 1.2.

Before this profile can be used some specific settings must be set. Please follow the steps below to set the required parameters:

- Change the heat curve settings in the touch screen or in the PC tool by going to the menu [System | Functions | Heating/cooling circuit 1\(2\) | Heat curve settings](#). Please select the type of heat curve you want or set your own curve, by selecting "Manual".
- Set the analog demand signal to the boiler in the touch screen or the PC tool by going to the menu [System | Installer settings | Hardware profile | Configure inputs and outputs | Analog outputs | Boiler 0-10V](#).
- At the row "Temperature threshold" you can setup the outdoor temperature where the Central Control Unit stops the heat demand to the boiler.
- Specify the lowest voltage the boiler can accept and at which inlet temperature this voltage represents.
- Specify the highest voltage the boiler can accept and at which temperature this voltage represents.

If you have two manifolds for underfloor heating and/or have Smart Radiator Thermostat's connected to the system the correct supply circuit will have to be set. By default, both the underfloor outputs and radiators are assigned to Heating/Cooling circuit 1 (pump 1).

In rooms with both underfloor heating and radiators, the two can have the same or different supply circuits, re-assign the underfloor and radiators to fit your system. When two underfloor circuits are being used or the supply for radiators is directly connected to the heating source, radiators will have to be assigned to H/C source. To re-assign outputs to a different supply circuit they will first need to be removed from the default circuit.

- Assign the room's outputs in the touch screen or PC tool by going to menu [System | Functions | Heating circuit 1\(2\) | Room assignment for this circuit](#) and select the rooms you want to control the pump.
- Assign radiators to the H/C source in the touch screen or PC tool by going to menu [System | Functions | H/C source | Room assignment](#) and select the room's radiators that are connected directly to the heating source.

When using outdoor thermometer on input T1 the sensor input must be selected as outdoor source in the settings. When Sentio's wired or wireless outdoor temperature sensor is enrolled to the system, it will be selected automatically. the sensor input must be selected as outdoor source in the settings. Sentio's wired and wireless outdoor temperature sensors will be selected automatically.

- Set the outdoor thermometer in the touch screen or in the PC tool by going to the menu [System | Installer settings | Hardware profile | Set outdoor temperature source](#).

Personal preference settings of profile 1.2

The High Temperature Cut Off feature is disabled by default. If the inlet temperature gets too high, heating will be blocked to protect the circuit.

- Change the High Temperature Cut Off feature in the touch screen or the PC-tool by going to the menu [System | Functions | Heating circuit 1\(2\) | Cut-Off temperatures](#). Enable the High Temperature Cut-Off, set the desired Cut-Off temperature and the delay, expressed in K.s (Kelvin/second).

If you have more than one manifold, you must set the High Temperature Cut-Off for both manifolds.

By default, the start signal to the pump/s is delayed by 5 minutes, to allow the thermal actuators to open, before the pump starts. If you need either to shorten or lengthen this delay. Please follow the steps below to do the changes:

- Change the pumps start delay in the touch screen or the PC tool by going to the menu [System | Installer settings | Hardware profile | Configure required inputs and output | Relays | Pump 1\(2\)](#) and change the “start delay” value to the desired value.

If you have more than one pump, you must set the “Start delay” for both pumps.

By default, the stop signal to the pump(s) is delayed by 3 minutes, to allow the thermal actuators to close, before the pump stops. If you need either to shorten or lengthen this delay. Please follow the steps below to do the changes:

- Change the pumps stop delay in the touch screen or the PC tool by going to the menu [System | Installer settings | Hardware profile | Configure required inputs and output | Relays | Pump 1\(2\)](#) and change the “stop delay” value to the desired value.

NOTE: By doing the wiring for the analog signal please take care for the correct use of the wires and terminals as described in paragraph 3.4.

A0 (0-10V output): “+”

GN (Ground – neutral): “-“

Profile 1.3.1 – District Heating, 1 ITC (Inlet Temperature Control) circuit

Profile 1.3.1 is a profile used for underfloor heating systems with district heating and Inlet Temperature Control that contains one manifold (circuit) to be controlled.

- If more than 8 outputs are required, an extension unit (EU-A) should be added to the system.
- Both, wired and wireless room thermostats and sensors can be used.
- It is possible to add Smart Radiator Thermostats
- It is mandatory to add an outdoor temperature sensor to the system so the ITC can work with a weather depended heat curve.
- In order for the ITC to adjust to the correct mixing temperature, both the inlet and return temperatures on the manifold are required to be measured.

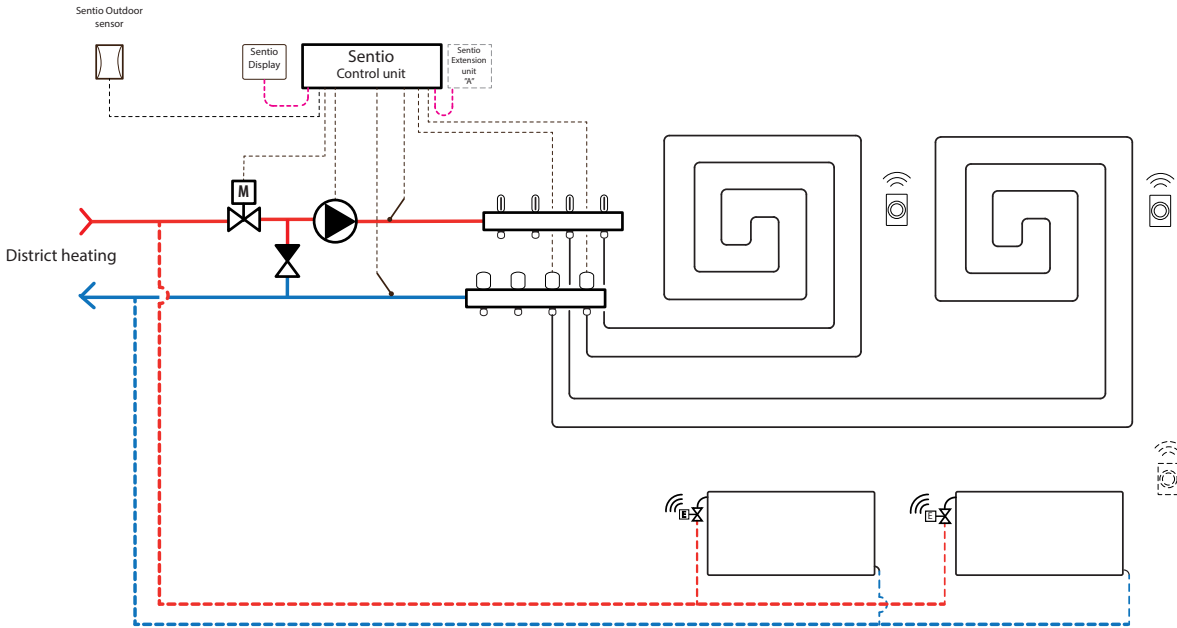

Wiring for profile 1.3.1

It is required to install an inlet and an return temperature sensor on the manifold in order to control the ITC servo (3-point control by default). The ITC servo should be installed as shown in the CCU Input/output list displayed in paragraph 3.4.

Setup of profile 1.3.1

To be able to set/adjust the settings for the Sentio system you need either the Sentio touch screen or the Sentio connection cable for PC.

In order to use profile 1.3.1 use the touch screen or the PC tool via the connection cable and follow the steps below:

- Change profile in the touch screen or the PC tool by going to the menu [System | Installer settings | Hardware profile | Change profile](#), select: 1.3.1 District heating with 1 ITC. The system will restart and load profile 1.3.1.

When using outdoor thermometer on input T1 the sensor input must be selected as outdoor source in the settings. When Sentio's wired or wireless outdoor temperature sensor is enrolled to the system, it will be selected automatically. the sensor input has to be selected as outdoor source in the settings. Sentio's wired and wireless outdoor temperature sensors will be selected automatically.

- Set the outdoor thermometer in the touch screen or in the PC tool by going to the menu [System | Installer settings | Hardware profile | Set outdoor temperature source](#).
- Select the type of servo connected in the touch screen or in the PC tool by going to the menu [System | Installer settings | Hardware profile | Configure required inputs and output | Servos | ITC Servo](#). By default, a 3-point servo type is selected. If a 0-10V servo is used, check if the selected mode fits the characteristic of the connected servo.

If you have rooms with both underfloor heating and Smart radiator thermostats, the two can have the same or different supply circuits, re-assign the underfloor outputs and radiators to fit your system. By default, both the underfloor and radiators are assigned to ITC 1 (pump 1). In rooms with both underfloor heating and radiators, the two can have the same or different supply circuits, re-assign the underfloor and radiators to fit your system. To re-assign outputs to a different supply circuit they will first need to be removed from the default circuit.

- Assign the room's outputs in the touch screen or PC tool by going to menu [System | Functions | ITC 1 | Room assignment for this circuit](#) and select the rooms you want to control the pump.
- Assign radiators to the H/C source in the touch screen or PC tool by going to menu [System | Functions | H/C source | Room assignment](#) and select the room's radiators that are connected directly to the heating source.

Personal preference settings of profile 1.3.1

When using an outdoor temperature sensor, the outdoor temperature cut-off will be active, this will stop the system from unnecessary heating when temperatures outdoor reach a certain threshold.

- Change the outdoor temperature cut-off in the touch screen or the PC tool by going to the menu [Programs | Winter & Summer mode | Heating settings](#) and set a maximum outdoor temperature.

The "Frost protection temperature" is used to protect the system from freezing. This setting keeps the minimum temperature above the set value to prevent freezing. If the temperature drops below the minimum, the system will ask for a temporary heat demand which will pump water around and create a flow through the system protecting it from freezing.

- Adjust frost protection settings in the touch screen or the PC tool by going to the menu [Programs | Winter & Summer mode | Global settings](#) and adjust the "Frost protection temperatures" to personal preferences.

The High Temperature Cut Off feature is disabled by default. If the inlet temperature gets too high, heating will be blocked to protect the circuit.

- Change the High Temperature Cut Off feature in the touch screen or the PC-tool by going to the menu [System | Functions | ITC 1 | Cut-Off temperatures](#). Enable the High Temperature Cut-Off, set the desired Cut-Off temperature and the delay, expressed in K.s (Kelvin/second).

By default, the start signal to the mixing pump is delayed by 5 minutes, to allow the thermal actuators to open, before the mixing pump(s) starts.

- Adjust the pump delay in the touch screen or the PC tool by going to the menu [System](#) | [Installer settings](#) | [Hardware profile](#) | [Configure required inputs and output](#) | [Relays](#) | [Pump 1](#) and change the “Start delay” value to the preferred value.

By default, the stop signal to the mixing pump is delayed by 3 minutes, to allow the mixing valve to close, before the mixing pump(s) stops.

- Adjust the pump stop delay in the touch screen or the PC tool by going to the menu [System](#) | [Installer settings](#) | [Hardware profile](#) | [Configure required inputs and output](#) | [Relays](#) | [Pump 1](#) and change the “Stop delay” value to the preferred value.

By default, the heat curve for the Inlet Temperature Controller (ITC) mixing circuit is set with a slope of 0.6.

- Change the heat curve in the touch screen or the PC tool by going to the menu [System](#) | [Functions](#) | [Inlet temperature control](#) | [ITC](#) | [Heat curve settings](#) | [Heat curve type](#). Select between different ways to set the heat curve:

Manual: Set the desired heating curve yourself.

Underfloor: Fixed heating curve with a slope of 0.6, optimized for underfloor heating systems.

Radiators: Fixed heating curve with a slope of 1.2.

By default, a maximum return temperature limit from the mixing circuit is set. This can be changed or switched off

- Find the return temperature limiter settings in the touch screen or the PC tool by going to the menu [System](#) | [Functions](#) | [Inlet temperature control](#) | [ITC](#) | [Return temperature limiter](#). Here you can select which kind of return restriction you want to use:

Off: There is no restriction on the return temperature

Maximum: Ensures that the return temperature does not exceed the set maximum temperature

Minimum: Ensures that the return temperature does not fall below the set minimum temperature.

Profile 1.3.2 – District Heating, 2 ITC (Inlet Temperature Control) circuits

Profile 1.3.2 is a profile used for underfloor heating systems with district heating and Inlet Temperature Control that contains two manifolds (loops) to be controlled.

- If more than 8 outputs are required, an extension unit (EU-A) shall be added to the system.
- It is possible to control up to 2 standard pumps, On/Off.
- Both, wired and wireless room thermostats and sensors can be used.
- By connecting two temperature sensors to the CCU, it is possible to protect your system against a too high inlet temperature.
- It is advised for this profile to have a Sentio touch screen included connected to the Sentio system in order to be able to monitor the total system.
- In order for the ITC to adjust to the correct mixing temperature, both, the inlet and return temperatures on the mixing unit are required to be measured.

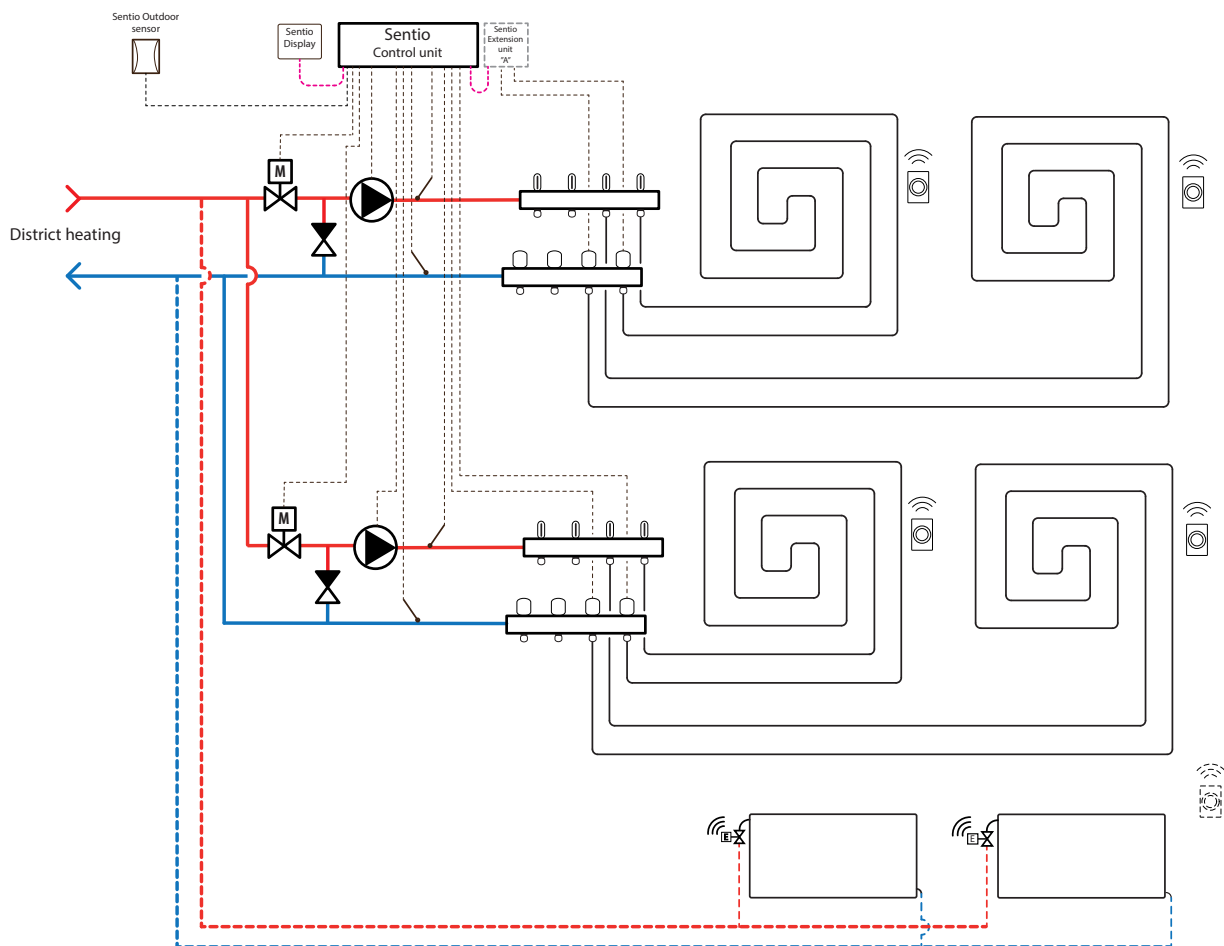

Wiring for profile 1.3.2

It is required to install an inlet and an return temperature sensor on the manifold in order to control the ITC servo (3-point control by default), this is required for each circuit separately, where circuit 1 inlet and return will be connected to T2 and T3 respectively. For circuit 2 this is T4 and T5 for its inlet and return respectively. The ITC servo should be installed as shown in the CCU Input/output list displayed in paragraph 3.4.

Setup of profile 1.3.2

To be able to set/adjust the settings for the Sentio system you need either the Sentio touch screen or the Sentio connection cable for PC.

In order to use profile 1.3.2 use the touch screen or the PC tool via the connection cable and follow the steps below:

- Change profile in the touch screen or in the PC tool by going to the menu [System | Installer settings | Hardware profile | Change profile](#), select: 1.3.2 District heating with 2 ITC. The system will restart and load profile 1.3.2.

When using outdoor thermometer on input T1 the sensor input must be selected as outdoor source in the settings. When Sentio's wired or wireless outdoor temperature sensor is enrolled to the system, it will be selected automatically. the sensor input must be selected as outdoor source in the settings. Sentio's wired and wireless outdoor temperature sensors will be selected automatically.

- Set the outdoor thermometer in the touch screen or in the PC tool by going to the menu [System | Installer settings | Hardware profile | Set outdoor temperature source](#).
- Select the type of servo(s) connected in the touch screen or in the PC tool by going to the menu [System | Installer settings | Hardware profile | Configure required inputs and output | Servos | ITC Servo](#). By default, a 3-point servo type is selected. If a 0-10V servo is used, check if the selected mode fits the characteristic of the connected servo. This setting must be done for each servo connected.

If you have rooms with both underfloor heating and Smart radiator thermostats, the two can have the same or different supply circuits, re-assign the underfloor outputs and radiators to fit your system. By default, both the underfloor and radiators are assigned to ITC 1 (pump 1). In rooms with both underfloor heating and radiators, the two can have the same or different supply circuits, re-assign the underfloor and radiators to fit your system. To re-assign outputs to a different supply circuit they will first need to be removed from the default circuit.

- Assign the room's outputs in the touch screen or PC tool by going to menu [System | Functions | ITC 1 | Room assignment for this circuit](#) and select the rooms you want to control the pump.
- Assign radiators to the H/C source in the touch screen or PC tool by going to menu [System | Functions | H/C source | Room assignment](#) and select the room's radiators that are connected directly to the heating source.

Personal preference settings of profile 1.3.2

When using an outdoor temperature sensor, the outdoor temperature cut-off will be active, this will stop the system from unnecessary heating when temperatures outdoor reach a certain threshold.

- Change the outdoor temperature cut-off in the touch screen or the PC tool by going to the menu [Programs | Winter & Summer mode | Heating settings](#) and set a maximum outdoor temperature.

The "Frost protection temperature" is used to protect the system from freezing. This setting keeps the minimum temperature above the set value to prevent freezing. If the temperature drops below the minimum, the system will ask for a temporary heat demand which will pump water around and create a flow through the system protecting it from freezing.

Adjust frost protection settings in the touch screen or the PC tool by going to the menu [Programs | Winter & Summer mode | Global settings](#) and adjust the "Frost protection temperatures" to personal preferences.

The High Temperature Cut Off feature is disabled by default. If the inlet temperature gets too high, heating will be blocked to protect the circuit.

- Change the High Temperature Cut Off feature in the touch screen or the PC-tool by going to the menu [System | Functions | Heating circuit 1\(2\) | Cut-Off temperatures](#). Enable the High Temperature Cut-Off, set the desired Cut-Off temperature and the delay, expressed in K.s (Kelvin/second).

If you have more than one manifold, you must set the High Temperature Cut-Off for both manifolds.

By default, the start signal to the mixing pump is delayed by 5 minutes, to allow the thermal actuators to open, before the mixing pump(s) starts.

- Adjust the pump start delay in the touch screen or the PC tool by going to the menu [System](#) | [Installer settings](#) | [Hardware profile](#) | [Configure required inputs and output](#) | [Relays](#) | [Pump 1\(2\)](#) and change the “Start delay” value to the preferred value.

By default, the stop signal to the mixing pump is delayed by 3 minutes, to allow the mixing valve to close, before the mixing pump(s) stops.

- Adjust the pump stop delay in the touch screen or the PC tool by going to the menu [System](#) | [Installer settings](#) | [Hardware profile](#) | [Configure required inputs and output](#) | [Relays](#) | [Pump 1](#) and change the “Stop delay” value to the preferred value.

Mixing pumps start/stop delay is set separately for each ITC circuit (ITC1 and ITC 2) make sure to set the desired value for both circuits.

By default, the heat curve for the Inlet Temperature Controller (ITC) mixing circuit is set with a slope of 0.6.

- Change the heat curve in the touch screen or the PC tool by going to the menu [System](#) | [Functions](#) | [Inlet temperature control](#) | [ITC 1\(2\)](#) | [Heat curve settings](#) | [Heat curve type](#). Select between different ways to set the heat curve:

Manual: Set the desired heating curve yourself.

Underfloor: Fixed heating curve with a slope of 0.6, optimized for underfloor heating systems.

Radiators: Fixed heating curve with a slope of 1.2.

Here you can also set any parallel displacement and minimum/maximum flow temperature.

The heat curve settings must be adapted separately for both ITC circuits (ITC1 and ITC 2). Make sure to set the desired value for both circuits.

By default, a maximum return temperature limit from the mixing circuit is set. This can be changed or switched off

- Find the return temperature limiter settings in the touch screen or the PC tool by going to the menu [System](#) | [Functions](#) | [Inlet temperature control](#) | [ITC 1\(2\)](#) | [Return temperature limiter](#). Here you can select which kind of return restriction you want to use:

Off: There is no restriction on the return temperature

Maximum: Ensures that the return temperature does not exceed the set maximum temperature

Minimum: Ensures that the return temperature does not fall below the set minimum temperature.

The return temperature limit is set separately for each ITC circuit (ITC1 and ITC 2) make sure to set the desired value for both circuits

Profile 2.2.1 - Condensing boiler, 1 ITC (Inlet Temperature Control) circuit

Profile 2.2.1 is a profile used for underfloor heating systems with a condensing boiler and one Inlet Temperature Control circuit.

- If more than 8 outputs are required, an extension unit (EU-A) should be added to the system.
- It is possible to control up to 2 standard pumps, On/Off.
- Both, wired and wireless room thermostats and sensors can be used.
- It is possible to add Smart Radiator Thermostats.
- It is mandatory to add an outdoor temperature sensor to the system so the ITC can work with a weather depended heat curve.
- For the ITC to adjust to the correct mixing temperature, both the inlet and return temperatures on the mixing unit are required to be measured.

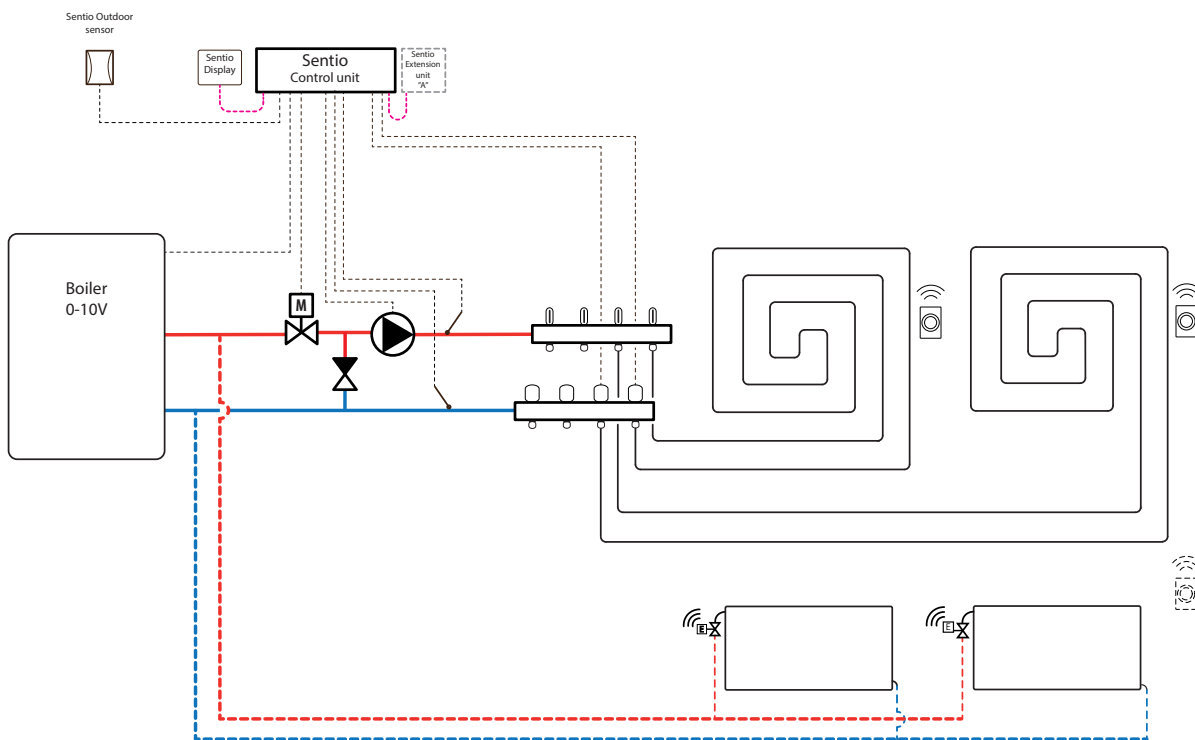

Wiring for profile 2.2.1

It is required to install an inlet and an return temperature sensor on the manifold to control the ITC servo (3-point control by default). The ITC servo should be installed as shown in the CCU Input/output list displayed in paragraph 3.4. The condensing boiler can be connected as shown in paragraph 4.8

Setup of profile 2.2.1

In order to be able to set/adjust the settings for the Sentio system you need either the Sentio touch screen or the Sentio connection cable for PC.

In order to use profile 2.2.1 use the touch screen or the PC tool via the connection cable and follow the steps below:

- Change profile in the touch screen or in the PC tool by going to the menu [System | Installer settings | Hardware profile | Change profile](#), select: 2.2.1 Condensing Boiler with ITC. The system will restart and load profile 2.2.1

When using outdoor thermometer on input T1 the sensor input must be selected as outdoor source in the settings. When Sentio's wired or wireless outdoor temperature sensor is enrolled to the system, it will be selected automatically. The sensor input must be selected as outdoor source in the settings. Sentio's wired and wireless outdoor temperature sensors will be selected automatically.

- Set the outdoor thermometer in the touch screen or in the PC tool by going to the menu [System | Installer settings | Hardware profile | Set outdoor temperature source](#)
- Select the type of servo(s) connected in the touch screen or in the PC tool by going to the menu [System | Installer settings | Hardware profile | Configure required inputs and output | Servos | ITC Servo](#). By default, a 3-point servo type is selected. If a 0-10V servo is used, check if the selected mode fits the characteristic of the connected servo.

If you have rooms with both underfloor heating and Smart radiator thermostats, the two can have the same or different supply circuits, re-assign the underfloor outputs and radiators to fit your system. By default, both the underfloor and radiators are assigned to ITC 1 (pump 1). In rooms with both underfloor heating and radiators, the two can have the same or different supply circuits, re-assign the underfloor and radiators to fit your system. To re-assign outputs to a different supply circuit they will first need to be removed from the default circuit.

- Assign the room's outputs in the touch screen or PC tool by going to menu [System | Functions | ITC 1 | Room assignment for this circuit](#) and select the rooms you want to control the pump.
- Assign radiators to the H/C source in the touch screen or PC tool by going to menu [System | Functions | H/C source | Room assignment](#) and select the room's radiators that are connected directly to the heating source.

Personal preference settings of profile 2.2.1

When using an outdoor temperature sensor, the outdoor temperature cut-off will be active, this will stop the system from unnecessary heating when temperatures outdoor reach a certain threshold.

- Change the outdoor temperature cut-off in the touch screen or the PC tool by going to the menu [Programs | Winter & Summer mode | Heating settings](#) and set a maximum outdoor temperature.

The "Frost protection temperature" is used to protect the system from freezing. This setting keeps the minimum temperature above the set value to prevent freezing. If the temperature drops below the minimum, the system will ask for a temporary heat demand which will pump water around and create a flow through the system protecting it from freezing.

- Adjust frost protection settings in the touch screen or the PC tool by going to the menu [Programs | Winter & Summer mode | Global settings](#) and adjust the "Frost protection temperatures" to personal preference.

The High Temperature Cut Off feature is disabled by default. If the inlet temperature gets too high, heating will be blocked to protect the circuit.

- Change the High Temperature Cut Off feature in the touch screen or the PC-tool by going to the menu [System | Functions | Heating circuit 1\(2\) | Cut-Off temperatures](#). Enable the High Temperature Cut-Off, set the desired Cut-Off temperature and the delay, expressed in K.s (Kelvin/second).

By default, the start signal to the mixing pump is delayed by 5 minutes, to allow the thermal actuators to open, before the mixing pump(s) starts.

- Adjust the pump start delay in the touch screen or the PC tool by going to the menu [System](#) | [Installer settings](#) | [Hardware profile](#) | [Configure required inputs and output](#) | [Relays](#) | [Pump 1](#) and change the “Start delay” value to the preferred value.

By default, the stop signal to the mixing pump is delayed by 3 minutes, to allow the mixing valve to close, before the mixing pump(s) stops.

- Adjust the pump stop delay in the touch screen or the PC tool by going to the menu [System](#) | [Installer settings](#) | [Hardware profile](#) | [Configure required inputs and output](#) | [Relays](#) | [Pump 1](#) and change the “Stop delay” value to the preferred value.

By default, the heat curve for the Inlet Temperature Controller (ITC) mixing circuit is set with a slope of 0.6.

- Change the heat curve in the touch screen or the PC tool by going to the menu [System](#) | [Functions](#) | [Inlet temperature control](#) | [ITC](#) | [Heat curve settings](#) | [Heat curve type](#). Select between different ways to set the heat curve:

Manual: Set the desired heating curve yourself.

Underfloor: Fixed heating curve with a slope of 0.6, optimized for underfloor heating systems.

Radiators: Fixed heating curve with a slope of 1.2.

By default, a maximum return temperature limit from the mixing circuit is set. This can be changed or switched off

- Find the return temperature limiter settings in the touch screen or the PC tool by going to the menu [System](#) | [Functions](#) | [Inlet temperature control](#) | [ITC](#) | [Return temperature limiter](#). Here you can select which kind of return restriction you want to use:

Off: There is no restriction on the return temperature

Maximum: Ensures that the return temperature does not exceed the set maximum temperature

Minimum: Ensures that the return temperature does not fall below the set minimum temperature.

Profile 2.2.2 - Condensing boiler, 2 ITC (Inlet Temperature Control) circuits

Profile 2.2.2 is used for an underfloor heating system with a condensing boiler and two Inlet Temperature Control circuits.

- If more than 8 outputs are required, an extension unit (EU-A) should be added to the system.
- It is possible to control up to 2 standard pumps, On/Off.
- Both wired and wireless room thermostats and sensors can be used.
- It is possible to add Smart Radiator Thermostats.
- It is advised for this profile to have a Sentio touch screen included connected to the Sentio system in order to be able to monitor the total system.
- It is mandatory to add an outdoor temperature sensor to the system so the ITC(s) can work with a weather depended heat curve.
- For the ITC(s) to adjust to the correct mixing temperature, both the inlet and return temperatures on the mixing unit are required to be measured.

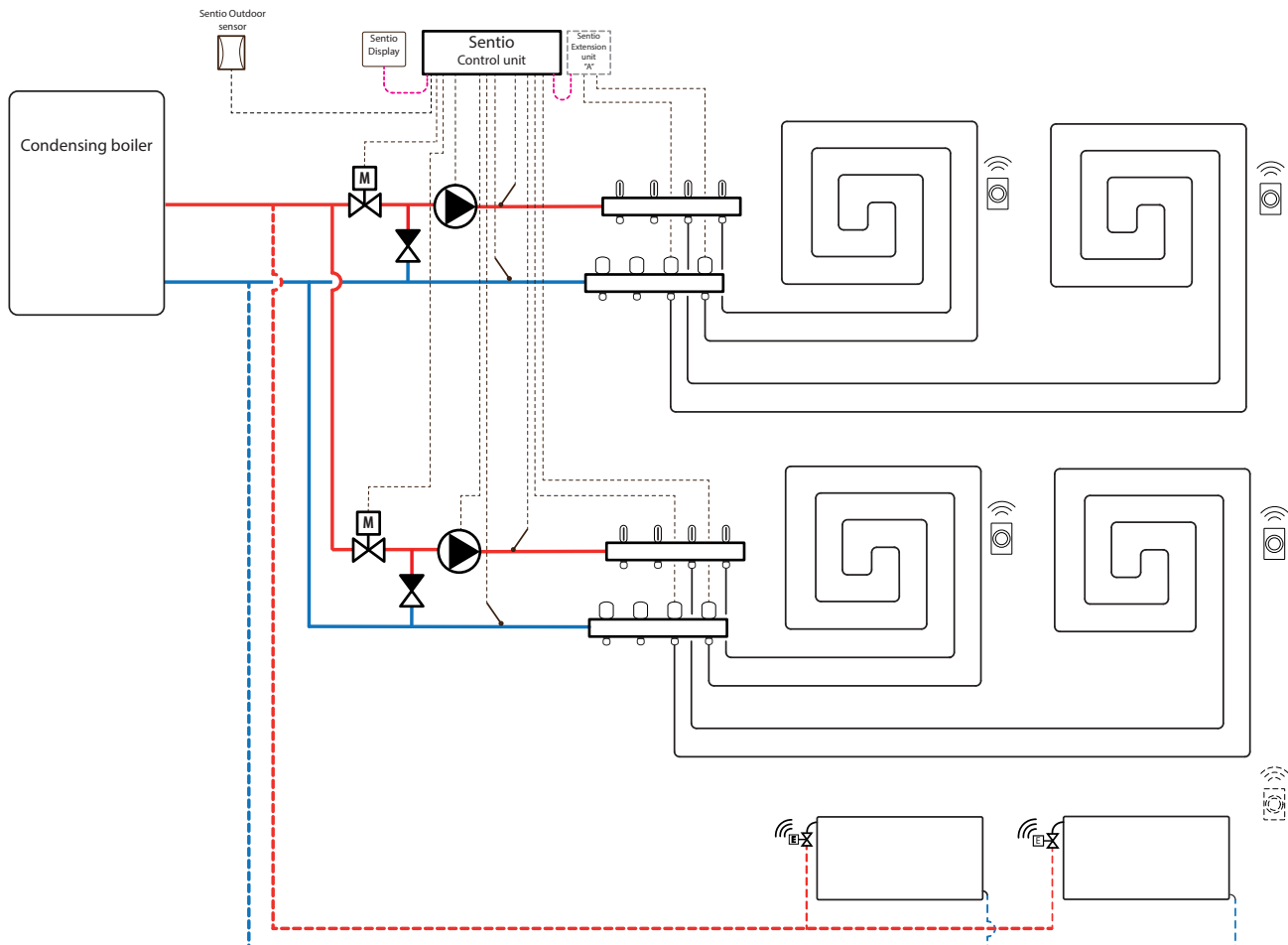

Wiring for profile 2.2.2

It is required to install an inlet and an return temperature sensor on the manifold in order to control the ITC servo (3-point control by default), this is required for each circuit separately, where circuit 1 inlet and return will be connected to T2 and T3 respectively. For circuit 2 this is T4 and T5 for its inlet and return respectively. The ITC servo should be installed as shown in the CCU Input/output list displayed in paragraph 3.4. The condensing boiler can be connected as shown in paragraph 4.8

Setup of profile 2.2.2

To be able to set/adjust the settings for the Sentio system you need either the Sentio touch screen or the Sentio connection cable for PC.

In order to use profile 2.2.2 use the touch screen or the PC tool via the connection cable and follow the steps below:

- Change profile in the touch screen or in the PC tool by going to the menu [System | Installer settings | Hardware profile | Change profile](#), select: 2.2.2 condensing boiler with 2 ITC. The system will restart and load profile 2.2.2.

When using outdoor thermometer on input T1 the sensor input must be selected as outdoor source in the settings. When Sentio's wired or wireless outdoor temperature sensor is enrolled to the system, it will be selected automatically. the sensor input must be selected as outdoor source in the settings. Sentio's wired and wireless outdoor temperature sensors will be selected automatically.

- Set the outdoor thermometer in the touch screen or in the PC tool by going to the menu [System | Installer settings | Hardware profile | Set outdoor temperature source](#).
- Select the type of servo(s) connected in the touch screen or in the PC tool by going to the menu [System | Installer settings | Hardware profile | Configure required inputs and output | Servos | ITC Servo](#). By default, a 3-point servo type is selected. If a 0-10V servo is used, check if the selected mode fits the characteristic of the connected servo. This setting must be done for each servo connected.

If you have rooms with both underfloor heating and Smart radiator thermostats, the two can have the same or different supply circuits, re-assign the underfloor outputs and radiators to fit your system. By default, both the underfloor and radiators are assigned to ITC 1 (pump 1). In rooms with both underfloor heating and radiators, the two can have the same or different supply circuits, re-assign the underfloor and radiators to fit your system. To re-assign outputs to a different supply circuit they will first need to be removed from the default circuit.

- Assign the room's outputs in the touch screen or PC tool by going to menu [System | Functions | ITC 1 | Room assignment for this circuit](#) and select the rooms you want to control the pump.
- Assign radiators to the H/C source in the touch screen or PC tool by going to menu [System | Functions | H/C source | Room assignment](#) and select the room's radiators that are connected directly to the heating source.

Personal preference settings of profile 2.2.2

When using an outdoor temperature sensor, the outdoor temperature cut-off will be active, this will stop the system from unnecessary heating when temperatures outdoor reach a certain threshold.

- Change the outdoor temperature cut-off in the touch screen or the PC tool by going to the menu [Programs | Winter & Summer mode | Heating settings](#) and set a maximum outdoor temperature.

The "Frost protection temperature" is used to protect the system from freezing. This setting keeps the minimum temperature above the set value to prevent freezing. If the temperature drops below the minimum, the system will ask for a temporary heat demand which will pump water around and create a flow through the system protecting it from freezing.

- Adjust frost protection settings in the touch screen or the PC tool by going to the menu [Programs | Winter & Summer mode | Global settings](#) and adjust the "Frost protection temperatures" to personal preference.

The High Temperature Cut Off feature is disabled by default. If the inlet temperature gets too high, heating will be blocked to protect the circuit.

- Change the High Temperature Cut Off feature in the touch screen or the PC-tool by going to the menu [System | Functions | Heating circuit 1\(2\) | Cut-Off temperatures](#). Enable the High Temperature Cut-Off, set the desired Cut-Off temperature and the delay, expressed in K.s (Kelvin/second).

If you have more than one manifold, you must set the High Temperature Cut-Off for both ITC circuits.

By default, the start signal to the mixing pump is delayed by 5 minutes, to allow the thermal actuators to open, before the mixing pump(s) starts.

- Adjust the pump start delay in the touch screen or the PC tool by going to the menu [System](#) | [Installer settings](#) | [Hardware profile](#) | [Configure required inputs and output](#) | [Relays](#) | [Pump 1\(2\)](#) and change the “Start delay” value to the preferred value.

By default, the stop signal to the mixing pump is delayed by 3 minutes, to allow the mixing valves to close, before the mixing pump(s) stops.

- Adjust the pump stop delay in the touch screen or the PC tool by going to the menu [System](#) | [Installer settings](#) | [Hardware profile](#) | [Configure required inputs and output](#) | [Relays](#) | [Pump 1\(2\)](#) and change the “Stop delay” value to the preferred value.

Mixing pumps start/stop delay is set separately for each ITC circuit (ITC1 and ITC 2) make sure to set the desired value for both circuits.

By default, the heat curve for the Inlet Temperature Controller (ITC) mixing circuit is set with a slope of 0.6.

- Change the heat curve in the touch screen or the PC tool by going to the menu [System](#) | [Functions](#) | [ITC 1\(2\)](#) | [Heat curve settings](#) | [Heat curve type](#). Select between different ways to set the heat curve:

Manual: Set the desired heating curve yourself.temperature.

Underfloor: Fixed heating curve with a slope of 0.6, optimized for underfloor heating systems.

Radiators: Fixed heating curve with a slope of 1.2.

By default, a maximum return temperature limit from the mixing circuit is set. This can be changed or switched off/

- Find the return temperature limiter settings in the touch screen or the PC tool by going to the menu [System](#) | [Functions](#) | [Inlet temperature control](#) | [ITC 1\(2\)](#) | [Return temperature limiter](#). Here you can select which kind of return restriction you want to use:

Off: There is no restriction on the return temperature.

Maximum: Ensures that the return temperature does not exceed the set maximum temperature.

Minimum: Ensures that the return temperature does not fall below the set minimum temperature.

Profile 3.3.0 – Heat Pump with Manual H/C changeover

Profile 3.3.0 is a profile used as well for underfloor heating as cooling with a heat pump. The switch over between heating and cooling has to be done manually.

- If more than 8 outputs are required, an extension unit (EU-A) should be added to the system.
- It is possible to control up to 2 standard pumps, On/Off.
- Both wired and wireless room thermostats and sensors can be used.
- It is possible to add Smart Radiator Thermostats.
- By connecting temperature sensors to the manifold, it is possible to protect the circuit against a too high inlet temperature. This can be done separately for the two different manifolds.
- It is advised for this profile to have a Sentio touch screen included connected to the Sentio system to be able to monitor the total system.
- It is mandatory to have an inlet temperature sensor connected for cooling.

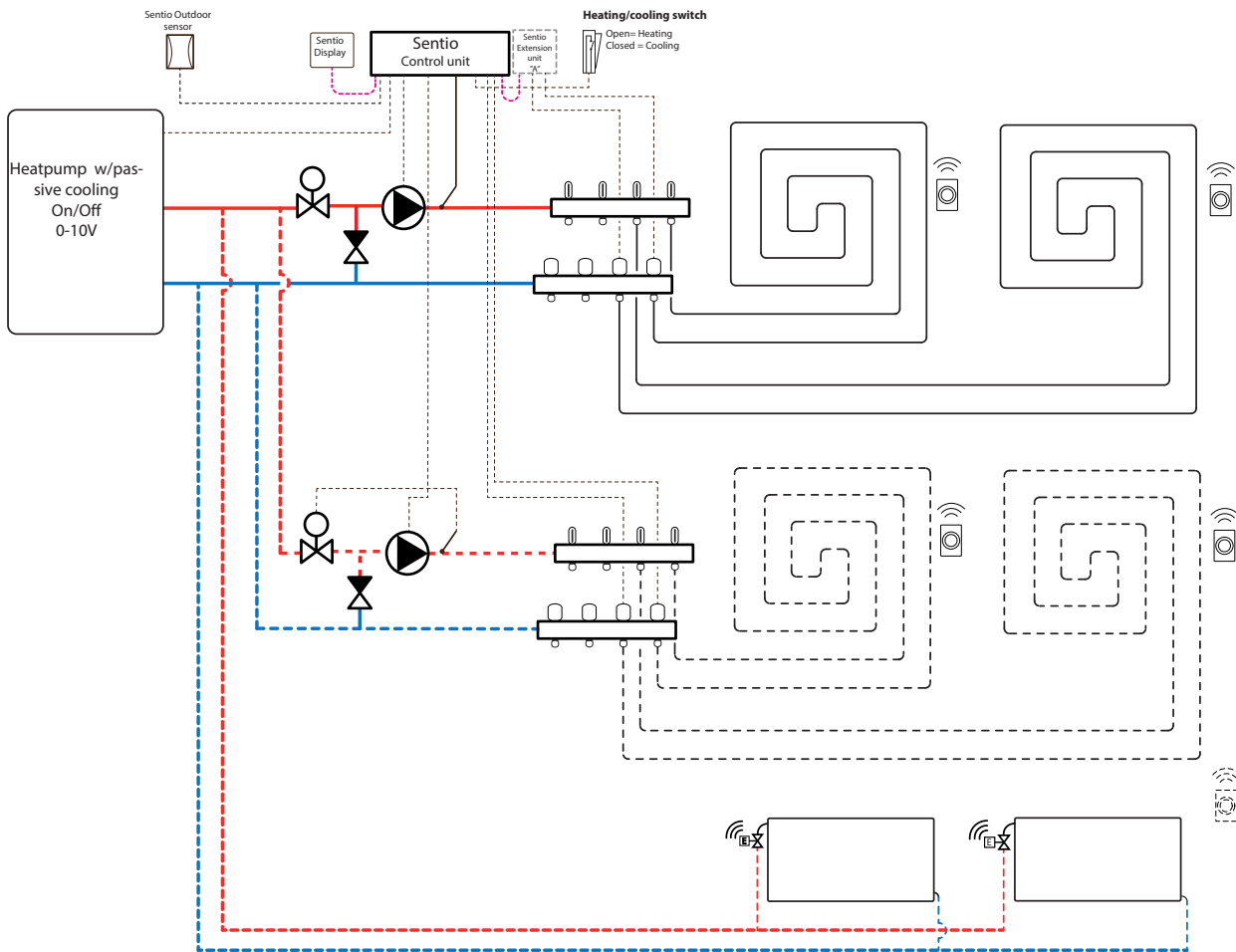

Wiring for profile 3.3.0

All the wiring for profile 3.3.0 is done according to the drawing found in paragraph 4.6.

Setup of profile 3.3.0

To be able to set/adjust the settings for the Sentio system you need either the Sentio touch screen or the Sentio connection cable for PC.

In order to use profile 3.3.0 use the touch screen or the PC tool via the connection cable and follow the steps below:

- Change profile in the touch screen or in the PC tool by going to the menu [System | Installer settings | Hardware profile | Change profile](#), select: 3.3.0 Heat pump with manual H/C changeover. The system will restart and load profile 3.3.0.

Before profile 3.3.0 can be used some specific settings must be set. Please follow the steps below to set the required parameters:

- Set the control specific to the heat pump in the touch screen or PC tool to the menu [System | Installer settings | Hardware profile | Configure required inputs and output | Analog outputs | Heat pump 0-10 V](#). With these analog outputs the heat pump will be set to cooling, idle or heating mode. The exact settings must be made with input from the heat pump supplier. Compatible heat pumps are listed in chapter 4.6 'Sentio & Heat pump' under 'Note'. By default, the Nibe heat pump settings are set.
- It is highly recommended to install a pipe sensor on the supply pipe.. This allows the system to calculate the dewpoint and prevent it from being reached while the system is in cooling mode.

When using outdoor thermometer on input T1 the sensor input must be selected as outdoor source in the settings. When Sentio's wired or wireless outdoor temperature sensor is enrolled to the system, it will be selected automatically. the sensor input has to be selected as outdoor source in the settings. Sentio's wired and wireless outdoor temperature sensors will be selected automatically.

- Set the outdoor thermometer in the touch screen or in the PC tool by going to the menu [System | Installer settings | Hardware profile | Set outdoor temperature source](#)

If you have two manifolds for underfloor heating/cooling and/or have Smart Radiator Thermostat's connected to the system the correct supply circuit will have to be set. By default, both the underfloor outputs and radiators are assigned to Heating/Cooling circuit 1 (pump 1). In rooms with both underfloor heating/cooling and radiators, the two can have the same or different supply circuits, re-assign the underfloor and radiators to fit your system. When two underfloor circuits are being used or the supply for radiators is directly connected to the heating/cooling source, radiators will have to be assigned to H/C source. To re-assign outputs to a different supply circuit they will first need to be removed from the default circuit.

- Assign the room's outputs in the touch screen or PC tool by going to menu [System | Functions | Heating circuit 1\(2\) | Room assignment for this circuit](#) and select the rooms you want to control the pump.
- Assign radiators to the H/C source in the touch screen or PC tool by going to menu [System | Functions | H/C source | Room assignment](#) and select the room's radiators that are connected directly to the heating/cooling source.

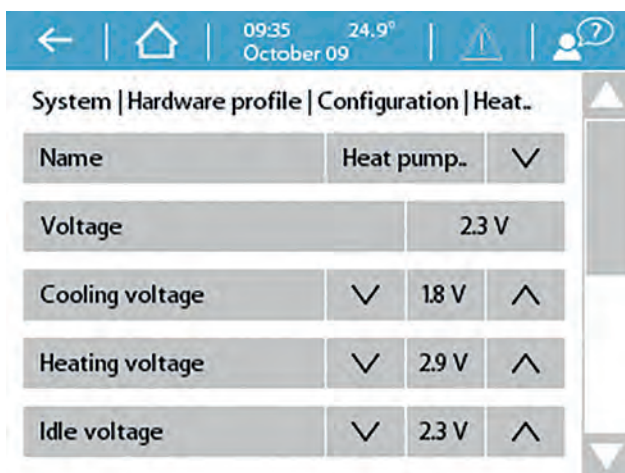

Personal preference settings of profile 3.3.0

If two mixing units are used instead of one the settings below need to be set separately for both mixing units.

By default, the start signal to the heat pump is delayed by 5 minutes to allow the thermal actuators to open before the heat pump starts.

- Adjust the heat pump start delay in the touch screen or the PC tool by going to the menu [System | Installer settings | Hardware profile | Configure required inputs and output | Voltage free relays | Heat pump](#) and change the “Start delay” value to the preferred value.

Profile 3.3.0 protects the connected rooms with a humidity measurement against condensation. When the difference between the inlet temperature and the calculated dewpoint gets too small, cooling will be blocked until there is no more risk of condensation. This difference can be changed, however lowering this value increases the risk of condensation, while increasing this value might lower the cooling efficiency.

- Adjust the default safety margin and minimum outdoor temperature in the touch screen or in the PC tool by going to the menu [Programs | Winter & Summer mode | Cooling settings](#) and change the “Room dew point band” to the preferred value.

When using an outdoor temperature sensor, the outdoor temperature cut-off will be active, this will stop the system from unnecessary heating or cooling when temperatures outdoor reach a certain threshold.

- Change the outdoor temperature cut-off in the touch screen or the PC tool by going to the menu [Programs | Winter & Summer mode | Heating settings/cooling settings](#) and set a maximum and a minimum outdoor temperature.

When using an inlet temperature sensor, it is possible to set a high temperature cut-off, if the inlet reaches a too high temperature, heating will be blocked to protect the underfloor heating system.

- Enable the high temperature cut-off, set the desired Cut-Off temperature and the delay, expressed in K.s (Kelvin/second) in the touch screen or the PC tool by going to the menu [System | Functions | heating/cooling circuit 1 \(2\) | Cut-off temperatures](#).

If you have more than one manifold, you must set the High Temperature Cut-Off for each manifold separately.

By default, the start signal to the mixing pump(s) is delayed by 5 minutes, to allow the thermal actuators to open, before the mixing pump(s) starts. This delay can be adjusted via:

- Change the start delay of the pump in the touch screen or in the PC tool by going to the menu [System | Hardware profile | Configure required inputs and output | Relays | Pump 1\(2\)](#) and change the “Start delay” value to the preferred value.

If more than one heating/cooling circuit is used, it is required to set the “Start delay” for both pumps (pump 1 and pump 2). By default, the stop signal to the mixing pump(s) is delayed by 3 minutes, to allow the thermal actuators to close, before the mixing pump(s) stops. This delay can be adjusted via:

- Change the stop delay of the pump in the touch screen or the PC tool by going to the menu [System | Hardware profile | Configure required inputs and output | Relays | Pump 1\(2\)](#) and change the “Stop delay” value to the value required.

If more than one heating/cooling circuit is used, it is required to set the “stop delay” for both pumps (pump 1 and pump 2).

Profile 3.3.1 – Heat Pump with Automatic H/C changeover

Profile 3.3.1 is a profile used as well for underfloor heating as cooling with a heat pump. The switch over between heating and cooling is done automatically depending on the outdoor temperature.

- If more than 8 outputs are required, an extension unit (EU-A) should be added to the system.
- It is possible to control up to 2 standard pumps, On/Off.
- Both wired and wireless room thermostats and sensors can be used.
- It is possible to add Smart Radiator Thermostats.
- By connecting temperature sensors to the manifold, it is possible to protect the circuit against a too high inlet temperature. This can be done separately for the two different manifolds.
- It is mandatory to have an outdoor temperature sensor connected.
- It is mandatory to have an inlet temperature sensor connected for cooling.

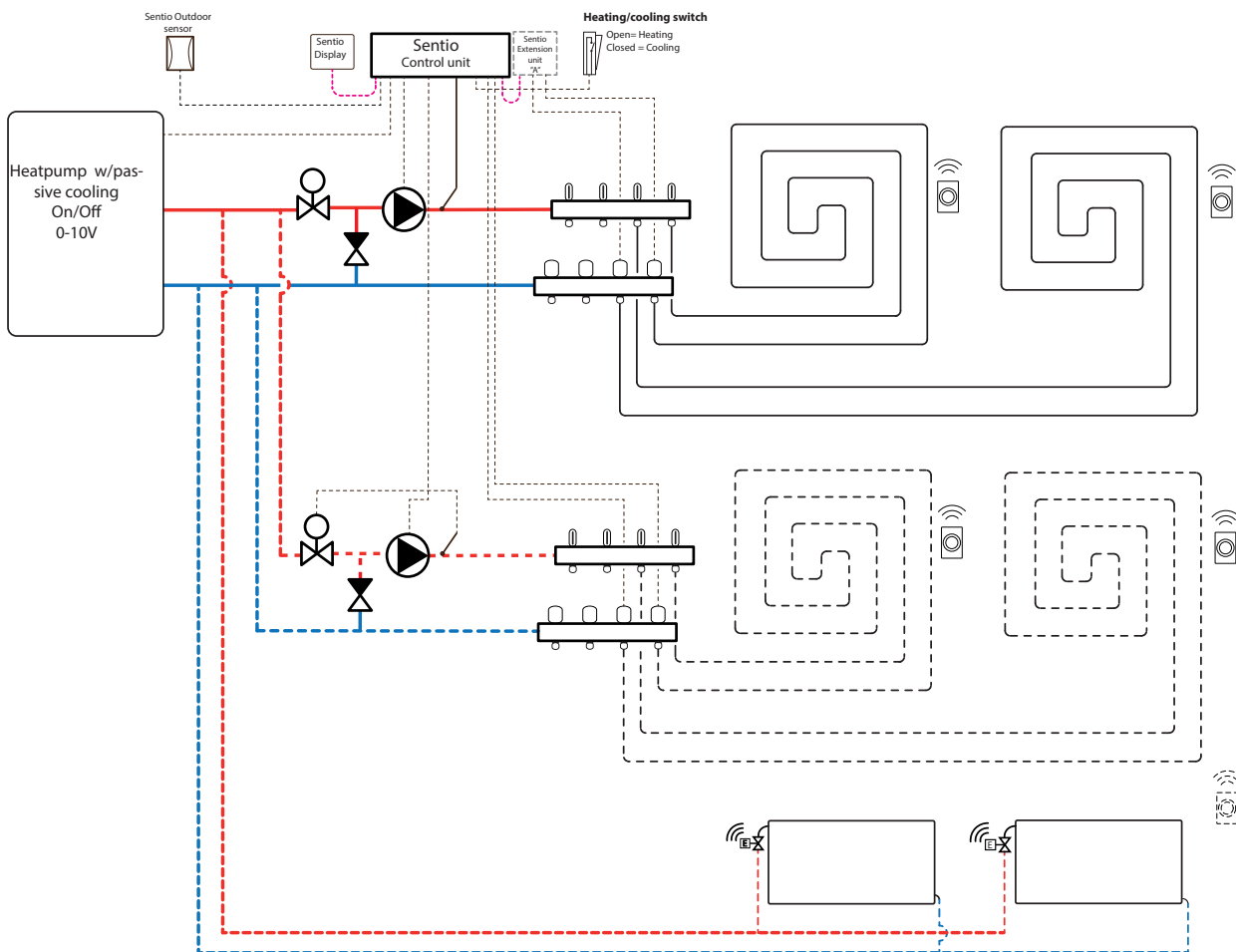

Wiring for profile 3.3.1

Wiring for profile 3.3.1 is done according to the drawing found in paragraph 4.6.

Setup of profile 3.3.1

To be able to set/adjust the settings for the Sentio system you need either the Sentio touch screen or the Sentio connection cable for PC.

In order to use profile 3.3.1 use the touchscreen or the connection cable in order to use the PC tool and follow the steps below:

- Change the profile in the touch screen or in the PC tool by going to the menu [System](#) | [Installer settings](#) | [Hardware profile](#) | [Change profile](#), select: 3.3.1 Heat pump with Automatic H/C changeover. The system shall restart and load profile 3.3.1.

Before profile 3.3.1 can be used some specific settings must be set. Please follow the steps below to set the required parameters:

- Set the control specific to the heat pump in the touch screen or PC tool to the menu [System](#) | [Installer settings](#) | [Hardware profile](#) | [Configure required inputs and output](#) | [Analog outputs](#) | [Heat pump 0-10 V](#). With these analog outputs the heat pump will be set to cooling, idle or heating mode. The exact settings must be made with input from the heat pump supplier. Compatible heat pumps are listed in paragraph 4.6 'Sentio & Heat pump' under 'Note'. By default, the Nibe heat pump settings are set.

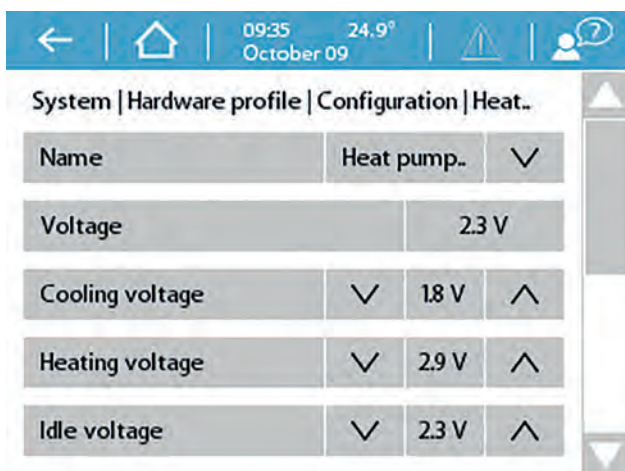

When using outdoor thermometer on input T1 the sensor input must be selected as outdoor source in the settings. When Sentio's wired or wireless outdoor temperature sensor is enrolled to the system, it will be selected automatically.

the sensor input has to be selected as outdoor source in the settings. Sentio's wired and wireless outdoor temperature sensors will be selected automatically.

- Set the outdoor thermometer in the touch screen or in the PC tool by going to the menu [System](#) | [Installer settings](#) | [Hardware profile](#) | [Set outdoor temperature source](#)

If you have two manifolds for underfloor heating/cooling and/or have Smart Radiator Thermostat's connected to the system the correct supply circuit will have to be set. By default, both the underfloor outputs and radiators are assigned to Heating/Cooling circuit 1 (pump 1). In rooms with both underfloor heating/cooling and radiators, the two can have the same or different supply circuits, re-assign the underfloor and radiators to fit your system. When two underfloor circuits are being used or the supply for radiators is directly connected to the heating/cooling source, radiators will have to be assigned to H/C source. To re-assign outputs to a different supply circuit they will first need to be removed from the default circuit.

- Assign the room's outputs in the touch screen or PC tool by going to menu [System](#) | [Functions](#) | [Heating circuit 1\(2\)](#) | [Room assignment for this circuit](#) and select the rooms you want to control the pump.
- Assign radiators to the H/C source in the touch screen or PC tool by going to menu [System](#) | [Functions](#) | [H/C source](#) | [Room assignment](#) and select the room's radiators that are connected directly to the heating/cooling source.

Personal preference settings of profile 3.3.1

If two mixing units are used instead of one the settings below need to be set separately for both mixing units.

Profile 3.3.1 protects the connected rooms with a humidity measurement against condensation. When the difference between the inlet temperature and the calculated dewpoint gets too small, cooling will be blocked until there is no more risk of condensation. This difference can be changed, however lowering this value increases the risk of condensation, while increasing this value might lower the cooling efficiency.

- Adjust the default safety margin and minimum outdoor temperature in the touch screen or in the PC tool by going to the menu [Programs](#) | [Winter & Summer mode](#) | [Cooling settings](#) and change the "Room dew point band" to the preferred value.

The minimum outdoor temperature to switch from heating to cooling or vice versa by default is set to 22 °C. The system is switched to heating for all the heat demands, under the set "minimum outdoor temperature" value with the corresponding outdoor temperature. To cool with lower outdoor temperature, lower this value. To heat with higher outdoor temperature, increase this value.

- Adjust the switchover to cooling temperature limit in the touch screen or the PC tool by going to the menu [Programs | Winter & Summer mode | Cooling settings](#) and change the "Minimum outdoor temperature" to the preferred value.

A cooldown time between switching between heating and cooling mode is introduced in the system to keep the heat pump clear from errors. A heat pump needs some time to stabilize from switching from heating to cooling and back. It is not advised to change this value only when necessary. Lowering this could severely damage the heat pump.

- Change the switching cooldown time in the touch screen or the PC tool by going to the menu [Programs | Winter & Summer mode | Cooling settings](#) and change the "Switching cooldown" to the preferred value.

The "deadband temperature" also called neutral temperature, is the temperature range around the "set-temperature" in which the system remains idle. This prevents the system from constantly switching on and off resulting in a less energy consuming system. By default, the deadband temperature is set to 4 °C

- Adjust the deadband temperature in the touch screen or the PC tool by going to the menu [Programs | Winter & Summer mode | Cooling settings](#) and change the "Deadband temperature" to the preferred value.

By default, the start signal to the heat pump is delayed by 5 minutes to allow the thermal actuators to open before the heat pump starts. This delay can be adjusted via:

- Change profile in the touch screen or the PC tool via the start screen by going to the menu [System | Installer settings | Hardware profile | Configure required inputs and outputs | Voltage free relays | Heat pump](#) and change the "Start delay" value to the preferred value.

When using an outdoor temperature sensor, the outdoor temperature cut-off will be active, this will stop the system from unnecessary heating or cooling when outdoor temperatures reach a certain threshold.

- Change the outdoor temperature cut-off in the touch screen or the PC tool by going to the menu [Programs | Winter & Summer mode | Heating settings/cooling settings](#) and set a maximum and minimum outdoor temperature.

When using an inlet temperature sensor, it is possible to set a high temperature cut-off, if the inlet reaches a too high temperature heating will be blocked to protect the underfloor heating system.

- Enable the high temperature cut-off, set the desired Cut-Off temperature and the delay, expressed in K.s (Kelvin/second) in the touch screen or the PC tool by going to the menu [System | Functions | heating/cooling circuit 1 \(2\) | Cut-off temperatures](#)

If you have more than one manifold, you must set the High Temperature Cut-Off for each manifold separately.

By default, the start signal to the mixing pump(s) is delayed by 5 minutes, to allow the thermal actuators to open, before the mixing pump(s) starts. This delay can be adjusted via:

- Change the start delay of the pump in the touch screen or in the PC tool by going to the menu [System | Hardware profile | Configure required inputs and output | Relays | Pump 1\(2\)](#) and change the "Start delay" value to the preferred value.

If more than one heating/cooling circuit is used, it is required to set the "Start delay" for both pumps (pump 1 and pump 2).

By default the stop signal to the mixing pump(s) is delayed by 3 minutes, to allow the thermal actuators to close, before the mixing pump(s) stops. This delay can be adjusted via:

- Change the stop delay of the pump in the touch screen or the PC tool by going to the menu [System | Hardware profile | Configure required inputs and output | Relays | Pump 1\(2\)](#) and change the "stop delay" value to the value required.

If more than one heating/cooling circuit is used, it is required to set the "Stop delay" for both pumps (pump 1 and pump 2).

Profile 3.3.2 – Heat Pump with Manual H/C changeover, 1 ITC (Inlet Temperature Control) circuit

Profile 3.3.2 is a profile used as well for underfloor heating as cooling with a heat pump. The switch over between heating and cooling must be done manually.

- If more than 8 outputs are required, an extension unit (EU-A) should be added to the system;
- Both wired and wireless room thermostats and sensors can be used;
- It is possible to add Smart Radiator Thermostats.
- It is advised for this profile to have a Sentio touch screen included connected to the Sentio system in order to be able to monitor the total system.
- It is mandatory to add an outdoor temperature sensor to the system so the ITC can work with a weather depended heat curve.
- In order for the ITC to adjust to the correct mixing temperature, both the inlet and return temperatures on the mixing unit are required to be measured.

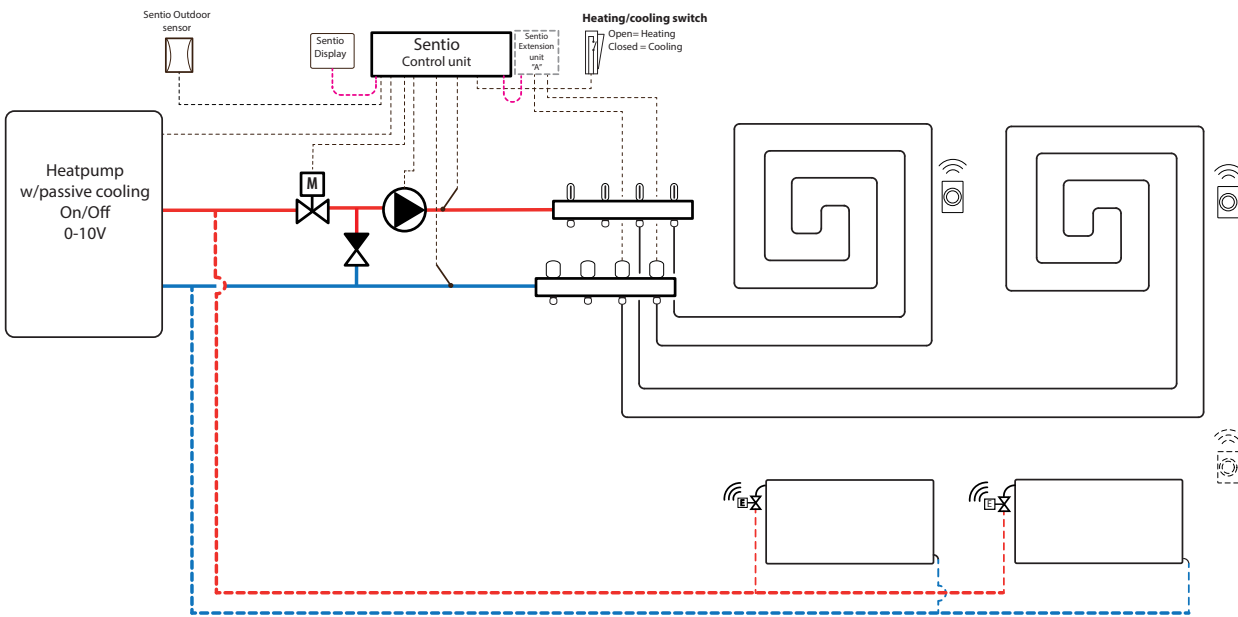

Wiring for profile 3.3.2

It is required to install an inlet and an return temperature sensor on the manifold in order to control the ITC servo (3-point control by default). The ITC servo should be installed as shown in the CCU Input/output list displayed in paragraph 3.4. If an extension unit is required due to the number of outputs the extension unit shall also be connected to the Sentio CCU.

Other wiring for profile 3.3.2 is done according to the drawing found in paragraph 4.6.

Setup of profile 3.3.2

To be able to set/adjust the settings for the Sentio system you need either the Sentio touch screen or the Sentio connection cable for PC.

In order to use profile 3.3.2 use the touch screen or the PC tool via the connection cable and follow the steps below:

- Change the profile in the touch screen or in the PC tool by going to the menu [System | Installer settings | Hardware profile | Change profile](#), select: 3.3.2 Heat pump with manual H/C changeover, 1 ITC. The system will restart and load profile 3.3.2.

Before profile 3.3.2 can be used some specific settings must be set. Please follow the steps below to set the required parameters:

- Set the control specific to the heat pump in the touch screen or PC tool to the menu [System | Installer settings | Hardware profile | Configure required inputs and output | Analog outputs | Heat pump 0-10 V](#). With these analog outputs the heat pump will be set to cooling, idle or heating mode. The exact settings must be made with input from the heat pump supplier. Compatible heat pumps are listed in chapter 4.6 'Sentio & Heat pump' under 'Note'. By default, the Nibe heat pump settings are set.

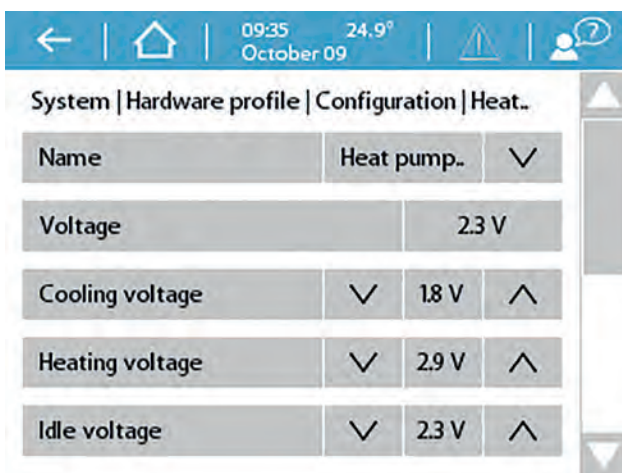

When using outdoor thermometer on input T1 the sensor input must be selected as outdoor source in the settings. When Sentio's wired or wireless outdoor temperature sensor is enrolled to the system, it will be selected automatically. the sensor input has to be selected as outdoor source in the settings. Sentio's wired and wireless outdoor temperature sensors will be selected automatically.

- Set the outdoor thermometer in the touch screen or in the PC tool by going to the menu [System | Installer settings | Hardware profile | Set outdoor temperature source](#).
- Select the type of servo connected in the touch screen or in the PC tool by going to the menu [System | Installer settings | Hardware profile | Configure required inputs and output | Servos | ITC Servo](#). By default a 3-point servo is selected. If a 0-10V servo is used, check if the selected mode fits the characteristic of the connected servo.

If you have rooms with both underfloor heating/cooling and Smart radiator thermostats, the two can have the same or different supply circuits, re-assign the underfloor outputs and radiators to fit your system. By default, both the underfloor and radiators are assigned to ITC 1 (pump 1). In rooms with both underfloor heating and radiators, the two can have the same or different supply circuits, re-assign the underfloor and radiators to fit your system. To re-assign outputs to a different supply circuit they will first need to be removed from the default circuit.

- Assign the room's outputs in the touch screen or PC tool by going to menu [System | Functions | ITC 1 | Room assignment for this circuit](#) and select the rooms you want to control the pump.
- Assign radiators to the H/C source in the touch screen or PC tool by going to menu [System | Functions | H/C source | Room assignment](#) and select the room's radiators that are connected directly to the heating/cooling source.

Personal preference settings of profile 3.3.2

By default, the start signal to the heat pump is delayed by 5 minutes in order to allow the thermal actuators to open before the heat pump starts.

- Adjust the heat pump delay in the touch screen or the PC tool by going to the menu [System | Installer settings | Hardware profile | Configure required inputs and output | Voltage free relays | Heat pump](#) and change the "Start delay" value to the preferred value.

Profile 3.3.2 protects the connected rooms with a humidity measurement against condensation. When the difference between the inlet temperature and the calculated dewpoint gets too small, the inlet temperature will be raised until there is no more risk of condensation. This difference can be changed, however lowering this value increases the risk of condensation, while increasing this value might lower the cooling efficiency.

- Adjust the default safety margin and minimum outdoor temperature in the touch screen or in the PC tool by going to the menu [Programs | Winter & Summer mode | Cooling settings](#) and change the "Room dew point band" to the preferred value.

When using an outdoor temperature sensor, the outdoor temperature cut-off will be active, this will stop the system from unnecessary heating or cooling when the outdoor temperature reach a certain threshold.

- Change the outdoor temperature cut-off in the touch screen or the PC tool by going to the menu [Programs | Winter & Summer mode | Heating settings/ Cooling settings](#) and set a maximum and minimum outdoor temperature.

The High Temperature Cut Off feature is disabled by default. If the inlet temperature gets too high, heating will be blocked to protect the circuit.

- Change the High Temperature Cut Off feature in the touch screen or the PC-tool by going to the menu [System | Functions | Heating circuit 1\(2\) | Cut-Off temperatures](#). Enable the High Temperature Cut-Off, set the desired Cut-Off temperature and the delay, expressed in K.s (Kelvin/second).

The "Frost protection temperature" is used to protect the system from freezing. This setting keeps the minimum temperature above the set value to prevent freezing. If the temperature drops below the minimum, the system will ask for a temporary heat demand which will pump water around and create a flow through the system protecting it from freezing.

- Adjust frost protection settings in the touch screen or the PC tool by going to the menu [System | Functions | ITC | Safety](#). And adjust the "Frost protection temperature" to personal preference.

By default, the start signal to the mixing pump is delayed by 5 minutes, to allow the thermal actuators to open, before the mixing pump(s) starts.

- Adjust the pump delay in the touch screen or the PC tool by going to the menu [System | Installer settings | Hardware profile | Configure required inputs and output | Relays | Pump 1](#) and change the "Start delay" value to the preferred value.

By default, the heat curve for the Inlet Temperature Controller (ITC) mixing circuit is set with a slope of 0.6.

- Change the heat curve in the touch screen or the PC tool by going to the menu [System | Functions | ITC | Heat curve settings | Heat curve type](#). Select between different ways to set the heat curve:

Manual: Set the desired heating curve yourself.

Underfloor: Fixed heating curve with a slope of 0.6, optimized for underfloor heating systems.

Radiators: Fixed heating curve with a slope of 1.2.

By default, a maximum return temperature limit from the mixing circuit is set. This can be changed or switched off.

- Find the return temperature limiter settings in the touch screen or the PC tool by going to the menu [System | Functions | ITC | Return temperature limiter](#). Here you can select which kind of return restriction you want to use:

Off: There is no restriction on the return temperature.

Maximum: Ensures that the return temperature does not exceed the set maximum temperature.

Minimum: Ensures that the return temperature does not fall below the set minimum temperature.

Profile 3.3.3 – Heat Pump with Automatic H/C changeover, 1 ITC (Inlet Temperature Control) circuit

Profile 3.3.3 is a profile used as well for underfloor heating as cooling with a heat pump. The switch over between heating and cooling is done automatically depending on the outdoor temperature.

- If more than 8 outputs are required, an extension unit (EU-A) should be added to the system.
- Both wired and wireless room thermostats and sensors can be used.
- It is possible to add Smart Radiator Thermostats.
- It is advised for this profile to have a Sention touch screen included connected to the Sention system in order to be able to monitor the total system.
- In order for the ITC to adjust to the correct mixing temperature, both the inlet and return temperatures on the mixing unit are required to be measured.
- It is mandatory to have an outdoor temperature sensor connected.

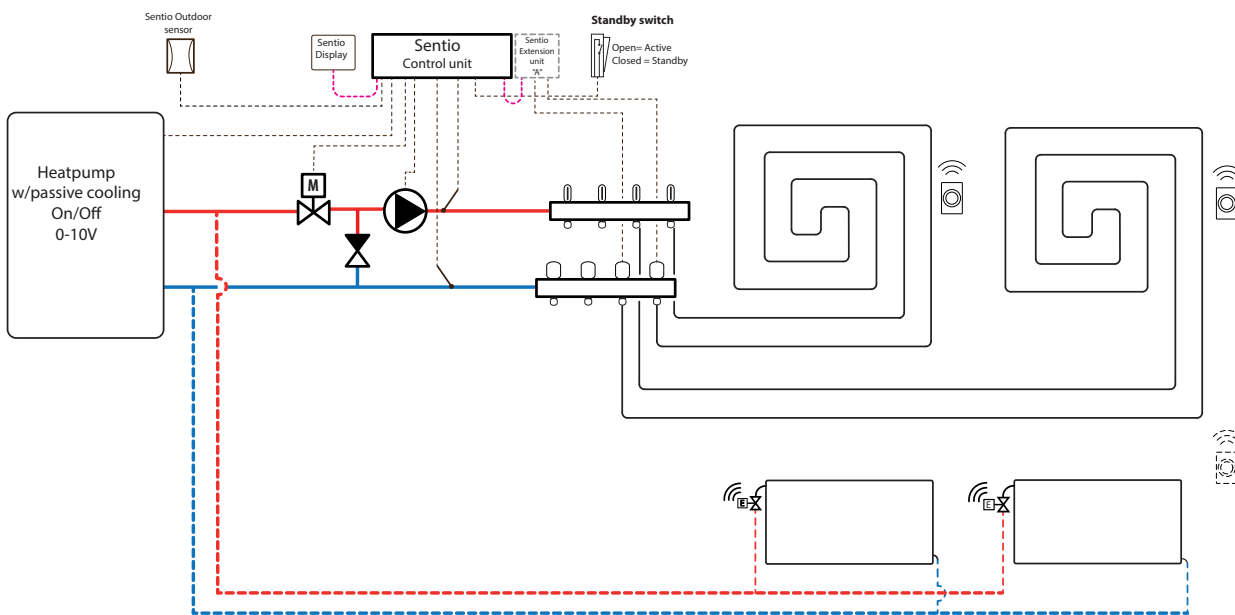

Wiring for profile 3.3.3

It is required to install an inlet and a return temperature sensor on the manifold in order to control the ITC servo (3-point control by default). The ITC servo should be installed as shown in the CCU Input/output list displayed in paragraph 3.4. If an extension unit is required due to the number of outputs the extension unit shall also be connected to the Sention CCU.

Other wiring for profile 3.3.3 is done according to the drawing found in paragraph 4.6.

Setup of profile 3.3.3

To be able to set/adjust the settings for the Sentio system you need either the Sentio touch screen or the Sentio connection cable for PC.

In order to use profile 3.3.3 use the touch screen or the PC tool via the connection cable and follow the steps below:

- Change the profile in the touch screen or in the PC tool by going to the menu [System | Installer settings | Hardware profile | Change profile](#), select: 3.3.3 Heat pump with Automatic H/C changeover, 1 ITC. The system will restart and load profile 3.3.3.

Before profile 3.3.3 can be used some specific settings must be set. Please follow the steps below to set the required parameters:

- Set the control specific to the heat pump in the touch screen or PC tool to the menu [System | Installer settings | Hardware profile | Configure required inputs and output | Analog outputs | Heat pump 0-10 V](#). With these analog outputs the heat pump will be set to cooling, idle or heating mode. The exact settings must be made with input from the heat pump supplier. Compatible heat pumps

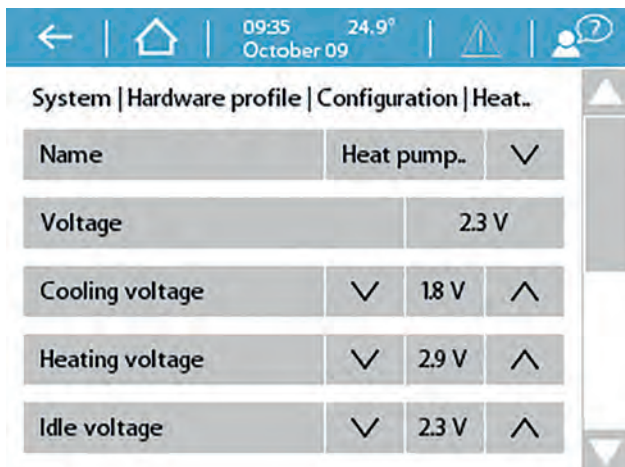

When using outdoor thermometer on input T1 the sensor input must be selected as outdoor source in the settings. When Sentio's wired or wireless outdoor temperature sensor is enrolled to the system, it will be selected automatically. the sensor input must be selected as outdoor source in the settings. Sentio's wired and wireless outdoor temperature sensors will be selected automatically.

- Set the outdoor thermometer in the touch screen or in the PC tool by going to the menu [System | Installer settings | Hardware profile | Set outdoor temperature source](#)
- Select the type of servo connected in the touch screen or in the PC tool by going to the menu [System | Installer settings | Hardware profile | Configure required inputs and output | Servos | ITC Servo](#). By default, a 3-point servo is selected. If a 0-10V servo is used, check if the selected mode fits the characteristic of the connected servo.

If you have rooms with both underfloor heating/cooling and Smart radiator thermostats, the two can have the same or different supply circuits, re-assign the underfloor outputs and radiators to fit your system. By default, both the underfloor and radiators are assigned to ITC 1 (pump 1). In rooms with both underfloor heating and radiators, the two can have the same or different supply circuits, re-assign the underfloor and radiators to fit your system. To re-assign outputs to a different supply circuit they will first need to be removed from the default circuit.

- Assign the room's outputs in the touch screen or PC tool by going to menu [System | Functions | ITC 1 | Room assignment for this circuit](#) and select the rooms you want to control the pump.
- Assign radiators to the H/C source in the touch screen or PC tool by going to menu [System | Functions | H/C source | Room assignment](#) and select the room's radiators that are connected directly to the heating/cooling source.

Personal preference settings of profile 3.3.3

By default, the start signal to the heat pump is delayed by 5 minutes to allow the thermal actuators to open before the heat pump starts.

- Adjust the heat pump start delay in the touch screen or the PC tool by going to the menu [System | Installer settings | Hardware profile | Configure required inputs and output | Voltage free relays | Heat pump](#) and change the “Start delay” value to the preferred value.

Profile 3.3.3 protects the connected rooms with a humidity measurement against condensation. When the difference between the inlet temperature and the calculated dewpoint gets too small, the inlet temperature will be raised until there is no more risk of condensation. This difference can be changed, however lowering this value increases the risk of condensation, while increasing this value might lower the cooling efficiency.

- Adjust the default safety margin and minimum outdoor temperature in the touch screen or in the PC tool by going to the menu [Programs | Winter & Summer mode | Cooling settings](#) and change the “Room dew point band” to the preferred value.

The minimum outdoor temperature to switch from heating to cooling or vice versa by default is set to 22 °C. The system is switched to heating for all the heat demands, under the set “minimum outdoor temperature” value with the corresponding outdoor temperature. To cool with lower outdoor temperature, lower this value. To heat with higher outdoor temperature, increase this value.

- Adjust the switchover to cooling temperature limit in the touch screen or the PC tool by going to the menu [Programs | Winter & Summer mode | Cooling settings](#) and change the “Minimum outdoor temperature” to the preferred value.

A cooldown time between switching between heating and cooling mode is introduced in the system to keep the heat pump clear from errors. A heat pump needs some time to stabilize from switching from heating to cooling and back. It is not advised to change this value only when necessary. Lowering this could severely damage the heat pump.

- Change the switching cooldown time in the touch screen or the PC tool by going to the menu [Programs | Winter & Summer mode | Cooling settings](#) and change the “Switching cooldown” to the preferred value.

The “deadband temperature” also called neutral temperature, is the temperature range around the “set-temperature” in which the system remains idle. This prevents the system from constantly switching on and off resulting in a less energy consuming system. By default, the deadband temperature is set to 4 °C

- Adjust the deadband temperature in the touch screen or the PC tool by going to the menu [Programs | Winter & Summer mode | Cooling settings](#) and change the “Deadband temperature” to the preferred value.

The High Temperature Cut Off feature is disabled by default. If the inlet temperature gets too high, heating will be blocked to protect the circuit.

- Change the High Temperature Cut Off feature in the touch screen or the PC-tool by going to the menu [System | Functions | Heating circuit 1\(2\) | Cut-Off temperatures](#). Enable the High Temperature Cut-Off, set the desired Cut-Off temperature and the delay, expressed in K.s (Kelvin/second).

The “Frost protection temperature” is used to protect the system from freezing. This setting keeps the minimum temperature above the set value to prevent freezing. If the temperature drops below the minimum, the system will ask for a temporary heat demand which will pump water around and create a flow through the system protecting it from freezing.

- Adjust frost protection settings in the touch screen or the PC tool by going to the menu [System | Functions | ITC | Safety](#). And adjust the “Frost protection temperature” to personal preference.

By default, the start signal to the mixing pump is delayed by 5 minutes, to allow the thermal actuators to open, before the mixing pump(s) starts.

- Adjust the pump delay in the touch screen or the PC tool by going to the menu [System | Installer settings | Hardware profile | Configure required inputs and output | Relays | Pump 1](#) and change the “Start delay” value to the preferred value.

By default, the heat curve for the Inlet Temperature Controller (ITC) mixing circuit is set with a slope of 0.6.

- Change the heat curve in the touch screen or the PC tool by going to the menu [System | Functions | ITC | Heat curve settings | Heat curve type](#). Select between different ways to set the heat curve:

Manual: Set the desired heating curve yourself.

Underfloor: Fixed heating curve with a slope of 0.6, optimized for underfloor heating systems.

Radiators: Fixed heating curve with a slope of 1.2.

By default, a maximum return temperature limit from the mixing circuit is set. This can be changed or switched off.

- Find the return temperature limiter settings in the touch screen or the PC tool by going to the menu [System | Functions | ITC | Return temperature limiter](#). Here you can select which kind of return restriction you want to use:

Off: There is no restriction on the return temperature.

Maximum: Ensures that the return temperature does not exceed the set maximum temperature.

Minimum: Ensures that the return temperature does not fall below the set minimum temperature.

Profile 4.1.1 – Dehumidifier with any single source and Manual H/C changeover

Profile 4.1.1 is a profile used for systems with dehumidifiers (including those with thermal integration). Any heating/cooling source can be added; for example a Heat pump, Condensing boiler ON/OFF or boiler 0-10V control.

- If more than 8 outputs are required, an extension unit (EU-A) should be added to the system.
- Both wired and wireless room thermostats and sensors can be used.
- It is possible to add Smart Radiator Thermostats.
- By connecting temperature sensors to the manifold it is possible to protect the circuit against a too high inlet temperature. This can be done separately for the two different manifolds.
- By connecting an extension unit with Voltage Free Relays (EU-VFR) it is possible to connect up to 4 separate dehumidifier units to control humidity in a room(s). Rooms with a dehumidifier connected require a humidity measurement from a room thermostat or sensor.
- By connection a sensor to terminal T1 it is possible to measure the source supply temperature, when for example dehumidifiers are connected directly on the supply pipe. This temperature will be taken as inlet temperature if no inlet temperature sensor is connected.
- It is advised for this profile to have a Sentio touch screen included connected to the Sentio system in order to be able to monitor the total system.
- It is mandatory to have an inlet temperature sensor connected for cooling.

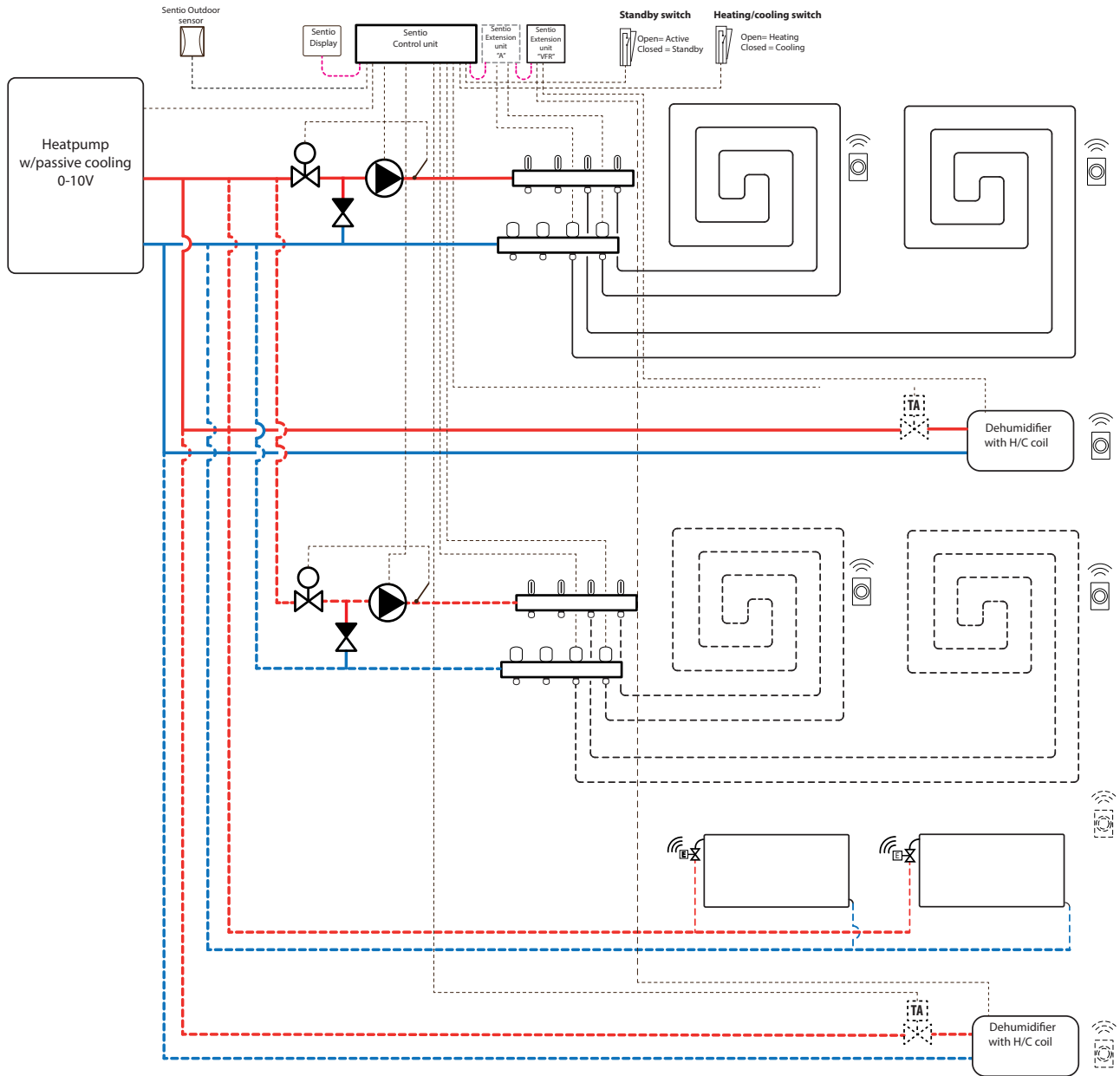

Wiring for profile 4.1.1

Depending on the source wiring can be done according to the drawings found in paragraphs 4.6 to 4.8. For connecting dehumidifiers follow instructions in paragraph 3.6.

Setup of profile 4.1.1

To be able to set/adjust the settings for the Sentio system you need either the Sentio touch screen or the Sentio connection cable for PC.

In order to use profile 4.1.1 use the touch screen or the PC tool via the connection cable and follow the steps below:

- Change the profile in the touch screen or in the PC tool by going to the menu [System](#) | [Installer settings](#) | [Hardware profile](#) | [Change profile](#), select 4.1.1 Dehumidifier, any source and manual H/C changeover. The system will restart and load profile 4.1.1

Before profile 4.1.1 can be used some specific settings must be set. As more heat/cooling sources are possible to be set in these profiles not all required settings are applicable to your system. Please follow the steps below to set the required parameters:

In case a 0-10V modulating heating/cooling source is connected, the desired heat curve must be set and the specific voltage output for analog signal corrected, this is by default 0V at 0% and 10V at 100%.

- Change the heat-curve settings in the touch screen or in the PC tool by going to the menu [System](#) | [Functions](#) | [Heating circuit 1\(2\)](#) | [Heat curve settings](#). Please select the type of heat curve you want to use or setup your own curve, by selecting “Manual”.
- Set the analog signal in the touch screen or the PC tool by going to the menu [System](#) | [Installer settings](#) | [Hardware profile](#) | [Configure inputs and outputs](#) | [Analog outputs](#) | [heat pump 0-10V](#)
- At the row “Temperature threshold” you can setup the outdoor temperature where the Central Control Unit stops the heat demand to the source.
- Specify the lowest voltage the boiler can accept and at which inlet temperature this voltage represents.
- Specify the highest voltage the boiler can accept and at which temperature this voltage represents.
- Specify the desired start and stop delays for the heat source.

When using outdoor thermometer on a free sensor input (terminals T3 or T5), the sensor input must be selected as outdoor source in the settings. When Sentio's wired or wireless outdoor temperature sensor is enrolled to the system, it will be selected automatically.

- Set the outdoor thermometer in the touch screen or in the PC tool by going to the menu [System](#) | [Installer settings](#) | [Hardware profile](#) | [Set outdoor temperature source](#)

To setup the dehumidifier unit connect the following steps must be done. The steps are depended on the dehumidifier's water supply connection and its location in the building. The correct water source must be set in the commissioning tool, an error will appear if this is not set.

- Set the water source in the touch screen or PC tool by going to the menu [System](#) | [Functions](#) | [Dehumidifier 1 \(4\)](#) | [Heating / cooling water source](#) and select the circuit that the dehumidifier is connected to. If there are multiple dehumidifiers connected this setting must be done for each of them.

When a dehumidifier is enrolled as “manual output assignment” (outside of the pre-set function of the extension unit) outputs must be assigned manually, these can be unused voltage free relays on the extension unit or unused outputs of the Central Control Unit. For any dehumidifier an extra pump and external thermal actuator(s) to control the water flow to the unit can be assigned.

- Assign outputs manually in the touch screen or PC tool by going to the menu [System](#) | [Functions](#) | [Dehumidifier 1 \(4\)](#) | [Output assignment](#) | [Drying/Thermal Integration demand](#) and assign the desired output.
- Assign an extra pump in the touch screen or PC tool by going to the menu [System](#) | [Functions](#) | [Dehumidifier 1 \(4\)](#) | [Output assignment](#) | [Pump demand \(optional\)](#) and select the output to which the extra pump is connected.
- Assign an external thermal actuator(EXTA) in the touch screen or PC tool by going to the menu [System](#) | [Functions](#) | [Dehumidifier 1 \(4\)](#) | [Output assignment](#) | [EXTA demand \(optional\)](#) and select the output to which the EXTA is connected.

By default, the filter lifetime of the dehumidifier is set to 2000 running hours, if this does not correspond with the filter used in the connected dehumidifier this time can be adjusted

- Change the filter time in the touch screen or PC tool by going to the menu [Systems | Functions | Dehumidifier 1 \(4\) | Air filter Management](#) and change the lifetime to the value fitting the selected filter type.

Each of the dehumidifier units must be assigned to the rooms that they are connected to. The unit can be connected to one room or multiple rooms, depending on how the unit is placed in the building.

- Assign rooms to the dehumidifier in the touch screen or PC tool by going to the menu [System | Functions | Dehumidifier 1 \(4\) | Room assignment](#) and select the rooms you want to connect to this unit.

Please repeat the steps above for the other dehumidifier units.

If you have two manifolds for underfloor heating/cooling and/or have Smart Radiator Thermostat's connected to the system the correct supply circuit will have to be set. By default, both the underfloor outputs and radiators are assigned to Heating/Cooling circuit 1 (pump 1). In rooms with both underfloor heating/cooling and radiators, the two can have the same or different supply circuits, re-assign the underfloor and radiators to fit your system. When two underfloor circuits are being used or the supply for radiators is directly connected to the heating/cooling source, radiators will have to be assigned to H/C source. To re-assign outputs to a different supply circuit they will first need to be removed from the default circuit.

- Assign the room's outputs in the touch screen or PC tool by going to menu [System | Functions | Heating circuit 1\(2\) | Room assignment for this circuit](#) and select the rooms you want to control the pump.
- Assign radiators to the H/C source in the touch screen or PC tool by going to menu [System | Functions | H/C source | Room assignment](#) and select the room's radiators that are connected directly to the heating/cooling source.

Personal Preference settings of profile 4.1.1

By default, the start signal to the source (boiler/heat pump) is delayed by 5 minutes to allow the thermal actuators to open, before the source starts. This default time can be adjusted to shorten or lengthen this delay with respect to the minimum required opening time for thermal actuators.

Change the source (boiler/heat pump) start delay in the touch screen or in the PC tool by going to the menu [System | Installer settings | Hardware profile | Configure required inputs and output | Voltage free relays | Boiler/ Heat pump](#) and change the "Start delay" value to the value you need.

Profile 4.1.1 protects the connected rooms with a humidity measurement against condensation. When the difference between the inlet temperature and the calculated dewpoint gets too small, cooling will be blocked until there is no more risk of condensation. This difference can be changed, however lowering this value increases the risk of condensation, while increasing this value might lower the cooling efficiency.

- Adjust the default safety margin and minimum outdoor temperature in the touch screen or in the PC tool by going to the menu [Programs | Winter & Summer mode | Cooling settings](#) and change the "Room dew point band" to the preferred value.

When using an outdoor temperature sensor the outdoor temperature cut-off will be active, this will stop the system from unnecessary heating or cooling when the outdoor temperature reach a certain threshold.

- Change the outdoor temperature cut-off in the touch screen or the PC tool by going to the menu [Programs | Winter & Summer mode | Heating settings/cooling settings](#) and set a maximum and minimum outdoor temperature.

When using an inlet temperature sensor it is possible to set a high temperature cut-off, if the inlet reaches a too high temperature heating will be blocked to protect the underfloor heating system.

- Enable the high temperature cut-off, set the desired Cut-Off temperature and the delay, expressed in K.s (Kelvin/second) in the touch screen or the PC tool by going to the menu [System | Functions | heating/cooling circuit 1 \(2\) | Cut-off temperatures](#).

If you have more than one manifold, you must set the High Temperature Cut-Off for each manifold separately.

When a dehumidifier unit is connected to the system, there are specific setting per unit and per room. For the unit it is possible to set the allowed supply temperature. Per room it is possible to set the desired relative humidity and control parameters for both drying and thermal integration.

- Change the units drying/integration settings in the touch screen or the PC-tool by going to the menu [System | Functions | Dehumidifier 1 \(4\) | Drying settings/ Thermal integration](#) Settings. Set the supply temperatures as desired.

If you have more than one dehumidifier, this setting must be done for each unit. However, the limitations to the supply temperature can affect all units connected to the same heating/cooling circuit.

- Change the rooms drying/integration settings in the touch screen or the PC-tool by going to the menu [Info | Room | Settings | Drying settings/ Thermal integration](#) Settings.

In case a room is not allowed to cool. This can be switched off; the room will not open its outputs when the system is in cooling mode.

- Change the allowed cooling in a room in the touch screen or the PC-tool by going to the menu [Info | Room | Settings | Summer Mode | Allow cooling](#) . Switch the setting to OFF if the room is not allowed to cool.

Profile 4.1.2 – Dehumidifier with any single source, Manual H/C changeover and one ITC (Inlet Temperature Control) circuit

Profile 4.1.2 is a profile used for systems with dehumidifiers (including those with thermal integration). Any heating/cooling source can be added; for example, a Heat pump, Condensing boiler ON/OFF or boiler 0-10V control.

- If more than 8 outputs are required, an extension unit (EU-A) should be added to the system.
- Both wired and wireless room thermostats and sensors can be used.
- It is possible to add Smart Radiator Thermostats.
- By connecting an extension unit with Voltage Free Relays (EU-VFR) it is possible to connect up to 4 separate dehumidifier units to control humidity in a room(s). Rooms with a dehumidifier connected need a humidity measurement from a thermostat or sensor.
- By connection a sensor to terminal T1 it is possible to measure the source supply temperature, when for example dehumidifiers are connected directly on the supply pipe. This temperature will be taken as inlet temperature if no inlet temperature sensor is connected.
- It is mandatory to add an outdoor temperature sensor to the system so the ITC can work with a weather depended heat curve.
- For the ITC to adjust to the correct mixing temperature, both the inlet and return temperatures on the mixing unit are required to be measured.
- It is advised for this profile to have a Sentio touch screen included connected to the Sentio system to be able to monitor the total system.

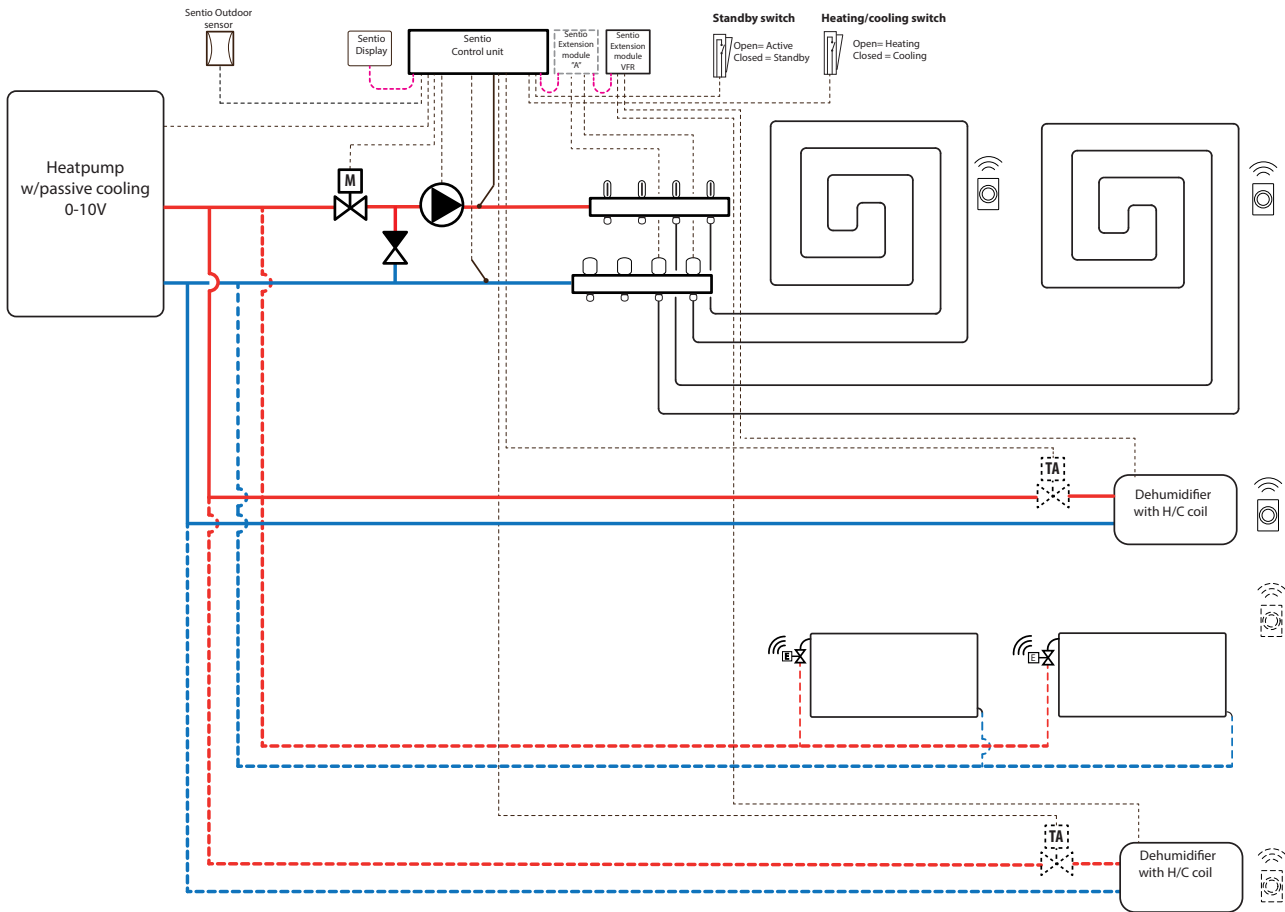

Wiring for profile 4.1.2

Depending on the heat source wiring can be done according to the drawings found in paragraphs 4.6 to 4.8. For connecting dehumidifiers follow instructions in paragraph 3.6.

Setup of profile 4.1.2

To be able to set/adjust the settings for the Sentio system you need either the Sentio touch screen or the Sentio connection cable for PC.

In order to use profile 4.1.2 use the touch screen or the PC tool via the connection cable and follow the steps below:

- Change the profile in the touch screen or in the PC tool by going to the menu [System | Installer settings | Hardware profile | Change profile](#), select '4.1.2 Dehumidifier, any source, 1 ITC, manual H/C changeover'. The system will restart and load profile 4.1.2

Before profile 4.1.2 can be used some specific settings must be set. As more heat/cooling sources are possible to be set in these profiles not all required settings are applicable to your system. Please follow the steps below to set the required parameters:

In case a 0-10V modulating heat source is connected, the desired heat curve has to be set and the specific voltage output for analog signal corrected, this is by default 0V at 0% and 10V at 100%.

- Set the analog signal in the touch screen or the PC tool by going to the menu [System | Installer settings | Hardware profile | Configure in- and outputs | Analog outputs](#).
- At the row "Temperature threshold" you can setup the outdoor temperature where the Central Control Unit stops the heat demand to the source.
- Specify the lowest voltage the boiler can accept and at which inlet temperature this voltage represents.
- Specify the highest voltage the boiler can accept and at which temperature this voltage represents.
- Specify the desired start and stop delays for the heat source.

When using outdoor thermometer on a free sensor input (terminals T4 or T5), the sensor input must be selected as outdoor source in the settings. When Sentio's wired or wireless outdoor temperature sensor is enrolled to the system, it will be selected automatically.

- Set the outdoor thermometer in the touch screen or in the PC tool by going to the menu [System | Installer settings | Hardware profile | Set outdoor temperature source](#).
- Select the type of servo connected in the touch screen or in the PC tool by going to the menu [System | Installer settings | Hardware profile | Configure required inputs and output | Servos | ITC Servo](#). By default, a 3-point servo is selected. If a 0-10V servo is used, check if the selected mode fits the characteristic of the connected servo.

To setup the dehumidifier unit connect the following steps must be done. The steps are depended on the dehumidifier's water supply connection and its location in the building. The correct water source must be set in the commissioning tool, an error will appear if this is not set.

- Set the water source in the touch screen or PC tool by going to the menu [System | Functions | Dehumidifier 1 \(4\) | Heating/ cooling water source](#) and select the circuit that the dehumidifier is connected to. If there are multiple dehumidifiers connected this setting must be done for each of them.

When a dehumidifier is enrolled as "manual output assignment" (outside of the pre-set function of the extension unit) outputs must be assigned manually, these can be unused voltage free relays on the extension unit or unused outputs of the Central Control Unit. For any dehumidifier an extra pump and external thermal actuator(s) to control the water flow to the unit can be assigned.

- Assign outputs manually in the touch screen or PC tool by going to the menu [System | Functions | Dehumidifier 1 \(4\) | Output assignment | Drying/Thermal Integration demand](#) and assign the desired output.
- Assign an extra pump in the touch screen or PC tool by going to the menu [System | Functions | Dehumidifier 1 \(4\) | Output assignment | Pump demand \(optional\)](#) and select the output to which the extra pump is connected.
- Assign an external thermal actuator(EXTA) in the touch screen or PC tool by going to the menu [System | Functions | Dehumidifier 1 \(4\) | Output assignment | EXTA demand \(optional\)](#) and select the output to which the EXTA is connected.

By default, the filter lifetime of the dehumidifier is set to 2000 hours, if this does not correspond with the filter used in the connected dehumidifier this time can be adjusted

- Change the filter time in the touch screen or PC tool by going to the menu [Systems | Functions | Dehumidifier 1 \(4\) | Air filter Management](#) and change the lifetime to the value fitting the selected filter type.

Each of the dehumidifier units must be assigned to the rooms that they are connected to. The unit can be connected to one room or multiple rooms, depending on how the unit is placed in the building.

- Assign rooms to the dehumidifier in the touch screen or PC tool by going to the menu [System | Functions | Dehumidifier 1 \(4\) | Room assignment](#) and select the rooms you want to connect to this unit.

Please repeat the steps above for the other dehumidifier units.

If you have rooms with both underfloor heating/cooling and Smart radiator thermostats, the two can have the same or different supply circuits, re-assign the underfloor outputs and radiators to fit your system. By default, both the underfloor and radiators are assigned to ITC 1 (pump 1). In rooms with both underfloor heating and radiators, the two can have the same or different supply circuits, re-assign the underfloor and radiators to fit your system. To re-assign outputs to a different supply circuit they will first need to be removed from the default circuit.

- Assign the room's outputs in the touch screen or PC tool by going to menu [System | Functions | ITC 1 | Room assignment for this circuit](#) and select the rooms you want to control the pump.
- Assign radiators to the H/C source in the touch screen or PC tool by going to menu [System | Functions | H/C source | Room assignment](#) and select the room's radiators that are connected directly to the heating/cooling source.

Personal Preference settings of profile 4.1.2

By default, the start signal to the source (boiler/heat pump) is delayed by 5 minutes to allow the thermal actuators to open, before the source starts. This default time can be adjusted to shorten or lengthen this delay with respect to the minimum required opening time for thermal actuators.

Change the source (boiler/heat pump) start delay in the touch screen or in the PC tool by going to the menu [System | Installer settings | Hardware profile | Configure required inputs and output | Voltage free relays | Boiler/ Heat pump](#) and change the "Start delay" value to the value you need.

Profile 4.1.2 protects the connected rooms with an humidity measurement against condensation. When the difference between the inlet temperature and the calculated dewpoint gets too small, the inlet temperature will be raised until there is no more risk of condensation. This difference can be changed, however lowering this value increases the risk of condensation, while increasing this value might lower the cooling efficiency.

- Adjust the default safety margin and minimum outdoor temperature in the touch screen or in the PC tool by going to the menu [Programs | Winter & Summer mode | Cooling settings](#) and change the "Room dew point band" to the preferred value.

When using an outdoor temperature sensor the outdoor temperature cut-off will be active, this will stop the system from unnecessary heating or cooling when temperatures outdoor reach a certain threshold.

- Change the outdoor temperature cut-off in the touch screen or the PC tool by going to the menu [Programs | Winter & Summer mode | Heating settings/ Cooling settings](#) and set a maximum and minimum outdoor temperature.

High temperature cut-off is always active for the ITC, the limit can be changed to fit your specific system. This limit stops the heat-flow if the maximum inlet temperature is exceeded by the set value to protect the underfloor heating circuit.

- Adjust the High temperature cut-off in the touch screen or the PC tool by going to the menu [System | Functions | ITC 1 | Safety](#), set the desired Cut-Off temperature and the delay, expressed in K.s (Kelvin/second).

The “Frost protection temperature” is used to protect the system from freezing. This setting keeps the minimum temperature above the set value to prevent freezing. If the temperature drops below the minimum, the system will ask for a temporary heat demand which will pump water around and create a flow through the system protecting it from freezing.

- Adjust frost protection settings in the touch screen or the PC tool by going to the menu [System](#) | [Functions](#) | [ITC](#) | [Safety](#). And adjust the “Frost protection temperature” to personal preference.

By default, the start signal to the mixing pump is delayed by 5 minutes, to allow the thermal actuators to open, before the mixing pump(s) starts.

- Adjust the pump delay in the touch screen or the PC tool by going to the menu [System](#) | [Installer settings](#) | [Hardware profile](#) | [Configure required inputs and output](#) | [Relays](#) | [Pump 1](#) and change the “Start delay” value to the preferred value.

By default, the heat curve for the Inlet Temperature Controller (ITC) mixing circuit is set with a slope of 0.6.

- Change the heat curve in the touch screen or the PC tool by going to the menu [System](#) | [Functions](#) | [ITC](#) | [Heat curve settings](#) | [Heat curve type](#). Select between different ways to set the heat curve:

Manual: Set the desired heating curve yourself.

Underfloor: Fixed heating curve with a slope of 0.6, optimized for underfloor heating systems.

Radiators: Fixed heating curve with a slope of 1.2.

By default, a maximum return temperature limit from the mixing circuit is set. This can be changed or switched off.

- Find the return temperature limiter settings in the touch screen or the PC tool by going to the menu [System](#) | [Functions](#) | [ITC](#) | [Return temperature limiter](#). Here you can select which kind of return restriction you want to use:

Off: There is no restriction on the return temperature

Maximum: Ensures that the return temperature does not exceed the set maximum temperature.

Minimum: Ensures that the return temperature does not fall below the set minimum temperature.

When a dehumidifier unit is connected to the system, there are specific settings per unit and per room. For the unit it is possible to set the allowed supply temperature. Per room it is possible to set the desired relative humidity and control parameters for both drying and thermal integration.

- Change the units drying/integration settings in the touch screen or the PC-tool by going to the menu [System](#) | [Functions](#) | [Dehumidifier 1 \(4\)](#) | [Drying settings/ Thermal integration Settings](#). Set the supply temperatures as desired.

If you have more than one dehumidifier, this setting must be done for each unit. However, the limitations to the supply temperature will affect all units connected to the same heating/cooling circuit.

- Change the rooms drying/integration settings in the touch screen or the PC-tool by going to the menu [Info](#) | [Room](#) | [Settings](#) | [Drying settings/ Thermal integration Settings](#).

In case a room is not allowed to cool. This can be switched off, the room will not open its outputs when the system is in cooling mode.

- Change the allowed cooling in a room in the touch screen or the PC-tool by going to the menu [Info](#) | [Room](#) | [Settings](#) | [Summer Mode](#) | [Allow cooling](#) . Switch the setting to OFF if the room is not allowed to cool.

Profile 4.1.3 – Dehumidifier with any single source, Manual H/C changeover, one ITC circuit and one heating/cooling circuit

Profile 4.1.3 is a profile used for systems with dehumidifiers (including those with thermal integration). Any heating/cooling source can be added; for example a Heat pump, Condensing boiler ON/OFF or boiler 0-10V control. This profile contains one ITC (inlet temperature control) circuit and one HCC (heating/cooling circuit)

- If more than 8 outputs are required, an extension unit (EU-A) should be added to the system.
- Both wired and wireless room thermostats and sensors can be used.
- It is possible to add Smart Radiator Thermostats.
- By connecting an extension unit with Voltage Free Relays (EU-VFR) it is possible to connect up to 4 separate dehumidifier units to control humidity in a room(s). Rooms with a dehumidifier connected need a humidity measurement from a room thermostat or sensor.
- By connection a sensor to terminal T1 it is possible to measure the source supply temperature, when for example dehumidifiers are connected directly on the supply pipe. This temperature will be taken as inlet temperature if no inlet temperature sensor is connected.
- It is mandatory to add an outdoor temperature to the system so the ITC can work with a weather depended heat curve.
- For the ITC to adjust to the correct mixing temperature, both the inlet and return temperatures on the mixing unit are required to be measured.
- By connecting a temperature sensor to the heating/cooling circuit, it is possible to protect the system against a too high inlet temperature.
- It is advised for this profile to have a Sentio touch screen included connected to the Sentio system to be able to monitor the total system.

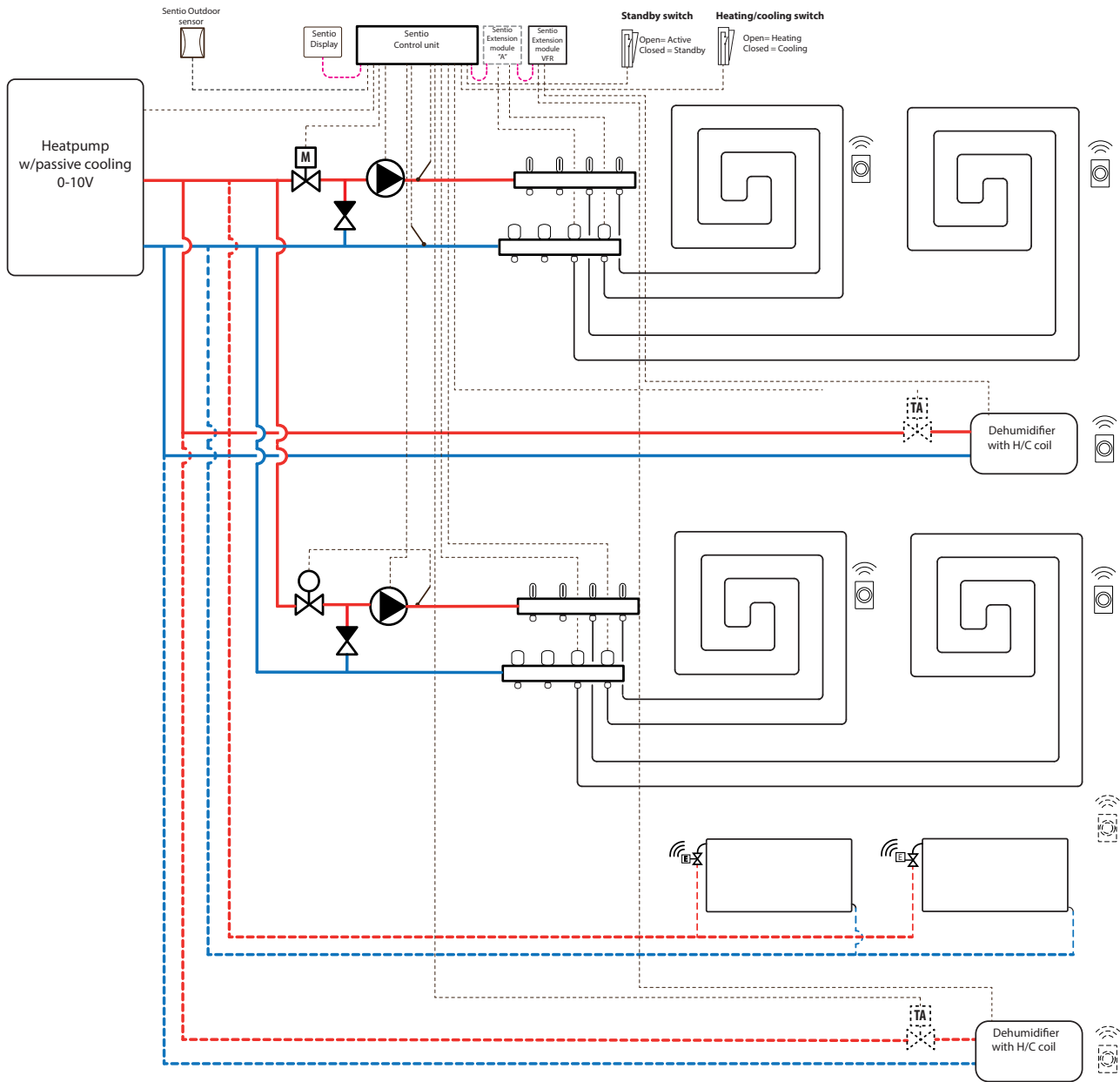

Wiring for profile 4.1.3

Depending on the heat source wiring can be done according to the drawings found in paragraphs 4.6 to 4.8. For connecting dehumidifiers follow instructions in paragraph 3.6.

Setup of profile 4.1.3

To be able to set/adjust the settings for the Sentio system you need either the Sentio touch screen or the Sentio connection cable for PC.

In order to use profile 4.1.3 use the touch screen or the PC tool via the connection cable and follow the steps below:

- Change the profile in the touch screen or in the PC tool by going to the menu [System | Installer settings | Hardware profile | Change profile](#), select '4.1.3 Dehumidifier, any source, 1 ITC, 1HCC, manual H/C changeover'. The system will restart and load profile 4.1.3.

Before profile 4.1.3 can be used some specific settings must be set. As more heat/cooling sources are possible to be set in these profiles not all required settings are applicable to your system. Please follow the steps below to set the required parameters:

In case a 0-10V modulating heat source is connected, the desired heat curve has to be set and the specific voltage output for analog signal corrected, this is by default 0V at 0% and 10V at 100%.

- Change the heat-curve settings in the touch screen or in the PC tool by going to the menu [System | Functions | Heating/cooling circuits | Heating circuit 1 | Heat curve settings](#). Please select the type of heat curve you want to use or setup your own curve, by selecting "Manual".
- Set the analog signal in the touch screen or the PC tool by going to the menu [System | Installer settings | Hardware profile | Configure in- and outputs | Analog outputs](#).
- At the row "Temperature threshold" you can setup the outdoor temperature where the Central Control Unit stops the heat demand to the source.
- Specify the lowest voltage the boiler can accept and at which inlet temperature this voltage represents.
- Specify the highest voltage the boiler can accept and at which temperature this voltage represents.
- Specify the desired start and stop delays for the heat source.

When using outdoor thermometer on a free sensor input

(terminals T5), the sensor input must be selected as outdoor source in the settings. When Sentio's wired or wireless outdoor temperature sensor is enrolled to the system, it will be selected automatically.

- Set the outdoor thermometer in the touch screen or in the PC tool by going to the menu [System | Installer settings | Hardware profile | Set outdoor temperature source](#).
- Select the type of servo connected in the touch screen or in the PC tool by going to the menu [System | Installer settings | Hardware profile | Configure required inputs and output | Servos | ITC Servo](#). By default, a 3-point servo is selected. If a 0-10V servo is used, check if the selected mode fits the characteristic of the connected servo.

To setup the dehumidifier unit connect the following steps must be done. The steps are depended on the dehumidifier's water supply connection and its location in the building. The correct water source must be set in the commissioning tool, an error will appear if this is not set.

- Set the water source in the touch screen or PC tool by going to the menu [System | Functions | Dehumidifier 1 \(4\) | Heating/cooling water source](#) and select the circuit that the dehumidifier is connected to. If there are multiple dehumidifiers connected this setting must be done for each of them.

When a dehumidifier is enrolled as "manual output assignment" (outdoor of the pre-set function of the extension unit) outputs must be assigned manually, these can be unused voltage free relays on the extension unit or unused outputs of the Central Control Unit. For any dehumidifier an extra pump and external thermal actuator(s) to control the water flow to the unit can be assigned.

- Assign outputs manually in the touch screen or PC tool by going to the menu [System | Functions | Dehumidifier 1 \(4\) | Output assignment | Drying/Thermal Integration demand](#) and assign the desired output.
- Assign an extra pump in the touch screen or PC tool by going to the menu [System | Functions | Dehumidifier 1 \(4\) | Output assignment | Pump demand \(optional\)](#) and select the output to which the extra pump is connected.

- Assign an external thermal actuator(EXTA) in the touch screen or PC tool by going to the menu [System | Functions | Dehumidifier 1 \(4\) | Output assignment | EXTA demand \(optional\)](#) and select the output to which the EXTA is connected.

By default, the filter lifetime of the dehumidifier is set to 2000 hours, if this does not correspond with the filter used in the connected dehumidifier this time can be adjusted.

- Change the filter time in the touch screen or PC tool by going to the menu [Systems | Functions | Dehumidifier 1 \(4\) | Air filter Management](#) and change the lifetime to the value fitting the selected filter type.

Each of the dehumidifier units must be assigned to the rooms that they are connected to. The unit can be connected to one room or multiple rooms, depending on how the unit is placed in the building.

- Assign rooms to the dehumidifier in the touch screen or PC tool by going to the menu [System | Functions | Dehumidifier 1 \(4\) | Room assignment](#) and select the rooms you want to connect to this unit.

Please repeat the steps above for the other dehumidifier units.

If you have rooms with both underfloor heating/cooling and Smart radiator thermostats, the two can have the same or different supply circuits, re-assign the underfloor outputs and radiators to fit your system. By default, both the underfloor and radiators are assigned to ITC 1 (pump 1). In rooms with both underfloor heating and radiators, the two can have the same or different supply circuits, re-assign the underfloor and radiators to fit your system. To re-assign outputs to a different supply circuit they will first need to be removed from the default circuit.

- Assign the room's outputs in the touch screen or PC tool by going to menu [System | Functions | ITC 1 | Room assignment for this circuit](#) and select the rooms you want to control the pump.
- Assign rooms to the Heating/cooling circuit in the touch screen or the PC tool by going to the menu [System | Functions | HCC 1 | Room assignment for this circuit](#). Select the rooms you want connected to the circuit and pump 2.

- Assign radiators to the H/C source in the touch screen or PC tool by going to menu [System | Functions | H/C source | Room assignment](#) and select the room's radiators that are connected directly to the heating/cooling source.

Personal Preference settings of profile 4.1.3

By default, the start signal to the source (boiler/heat pump) is delayed by 5 minutes to allow the thermal actuators to open, before the source starts. This default time can be adjusted to shorten or lengthen this delay with respect to the minimum required opening time for thermal actuators.

Change the source (boiler/heat pump) start delay in the touch screen or in the PC tool by going to the menu [System | Installer settings | Hardware profile | Configure required inputs and output | Voltage free relays | Boiler/ Heat pump](#) and change the "Start delay" value to the value you need.

Profile 4.1.3 protects the connected rooms with a humidity measurement against condensation. When the difference between the inlet temperature and the calculated dewpoint gets too small, the inlet temperature will be raised or blocked until there is no more risk of condensation. This difference can be changed, however lowering this value increases the risk of condensation, while increasing this value might lower the cooling efficiency.

- Adjust the default safety margin and minimum outdoor temperature in the touch screen or in the PC tool by going to the menu [Programs | Winter & Summer mode | Cooling settings](#) and change the "Room dew point band" to the preferred value.

When using an outdoor temperature sensor the outdoor temperature cut-off will be active, this will stop the system from unnecessary heating or cooling when the outdoor temperature reach a certain threshold.

- Change the outdoor temperature cut-off in the touch screen or the PC tool by going to the menu [Programs | Winter & Summer mode | Heating settings/ Cooling settings](#) and set a maximum and minimum outdoor temperature.

High temperature cut-off is always active for the ITC, the limit can be changed to fit your specific system. This limit stops the heat-flow if the maximum inlet temperature is exceeded by the set value to protect the underfloor heating circuit.

- Adjust the High temperature cut-off in the touch screen or the PC tool by going to the menu [System | Functions | ITC / HCC | Safety](#), set the desired Cut-Off temperature and the delay, expressed in K.s (Kelvin/second).

The High Temperature Cut-Off must be set for each manifold separately.

The “Frost protection temperature” is used to protect the system from freezing. This setting keeps the minimum temperature above the set value to prevent freezing. If the temperature drops below the minimum, the system will ask for a temporary heat demand which will pump water around and create a flow through the system protecting it from freezing.

- Adjust frost protection settings in the touch screen or the PC tool by going to the menu [System | Functions | ITC | Safety](#). And adjust the “Frost protection temperature” to personal preference.

By default, the start signal to the mixing pump is delayed by 5 minutes, to allow the thermal actuators to open, before the mixing pump(s) starts.

- Adjust the pump delay in the touch screen or the PC tool by going to the menu [System | Installer settings | Hardware profile | Configure required inputs and output | Relays | Pump 1 \(2\)](#) and change the “Start delay” value to the preferred value. This must be set for each pump separately.

By default, the heat curve for the Inlet Temperature Controller (ITC) mixing circuit is set with a slope of 0.6.

- Change the heat curve in the touch screen or the PC tool by going to the menu [System | Functions | ITC | Heat curve settings | Heat curve type](#). Select between different ways to set the heat curve:

Manual: Set the desired heating curve yourself.

Underfloor: Fixed heating curve with a slope of 0.6, optimized for underfloor heating systems.

Radiators: Fixed heating curve with a slope of 1.2.

By default, a maximum return temperature limit from the mixing circuit is set. This can be changed or switched off.

- Find the return temperature limiter settings in the touch screen or the PC tool by going via the start screen to the menu [System | Functions | ITC | Return temperature limiter](#). Here you can select which kind of return restriction you want to use:

Off: There is no restriction on the return temperature
Maximum: Ensures that the return temperature does not exceed the set maximum temperature.

Minimum: Ensures that the return temperature does not fall below the set minimum temperature.

When a dehumidifier unit is connected to the system, there are specific settings per unit and per room. For the unit it is possible to set the allowed supply temperature. Per room it is possible to set the desired relative humidity and control parameters for both drying and thermal integration.

- Change the units drying/integration settings in the touch screen or the PC-tool by going to the menu [System | Functions | Dehumidifier 1 \(4\) | Drying settings/ Thermal integration Settings](#). Set the supply temperatures as desired.

If you have more than one dehumidifier, this setting must be done for each unit. However, the limitations to the supply temperature can affect all units connected to the same heating/cooling circuit.

- Change the rooms drying/integration settings in the touch screen or the PC-tool by going to the menu [Info | Room | Settings | Drying settings/ Thermal integration Settings](#).

In case a room is not allowed to cool. This can be switched off, the room will not open its outputs when the system is in cooling mode.

- Change the allowed cooling in a room in the touch screen or the PC-tool by going to the menu [Info | Room | Settings | Summer Mode | Allow cooling](#). Switch the setting to OFF if the room is not allowed to cool.

Profile 4.1.4 – Dehumidifier with any single source, Manual H/C changeover, two ITC circuits and one heating/cooling circuit

Profile 4.1.4 is a profile used for systems with dehumidifiers (including those with thermal integration). Any heating/cooling source can be added; for example a Heat pump, Condensing boiler ON/OFF or boiler 0-10V control. This profile contains two ITC (inlet temperature control) circuits and one HCC (heating/cooling circuit).

- If more than 8 outputs are required, an extension unit (EU-A) should be added to the system.
- Both wired and wireless room thermostats and sensors can be used.
- It is possible to add Smart Radiator Thermostats.
- By connecting a pipe sensor on the heating/cooling circuit (HCC) to the CCU, it is possible to protect this circuit against a too high inlet temperature.
- By connecting an extension unit with Voltage Free Relays (EU-VFR) it is possible to connect up to 4 separate dehumidifier units to control humidity in a room(s). Rooms with a dehumidifier connected need a humidity measurement from a room thermostat or sensor.
- By connection a sensor to terminal T1 it is possible to measure the source supply temperature, when for example dehumidifiers are connected directly on the supply pipe. This temperature will be taken as inlet temperature if no inlet temperature sensor is connected.
- It is mandatory to add an outdoor temperature sensor to the system so the ITC(s) can work with a weather depended heat curve.
- In order for the ITC servos to adjust to the correct mixing temperature, all the inlet and return temperatures on the mixing units with ITC are required to be measured.
- To measure outdoor temperature, only a wired or wireless outdoor temperature sensor can be connected, as all sensor inputs on the CCU are reserved for pipe sensors.
- It is advised for this profile to have a Sentio touch screen included connected to the Sentio system to be able to monitor the total system.

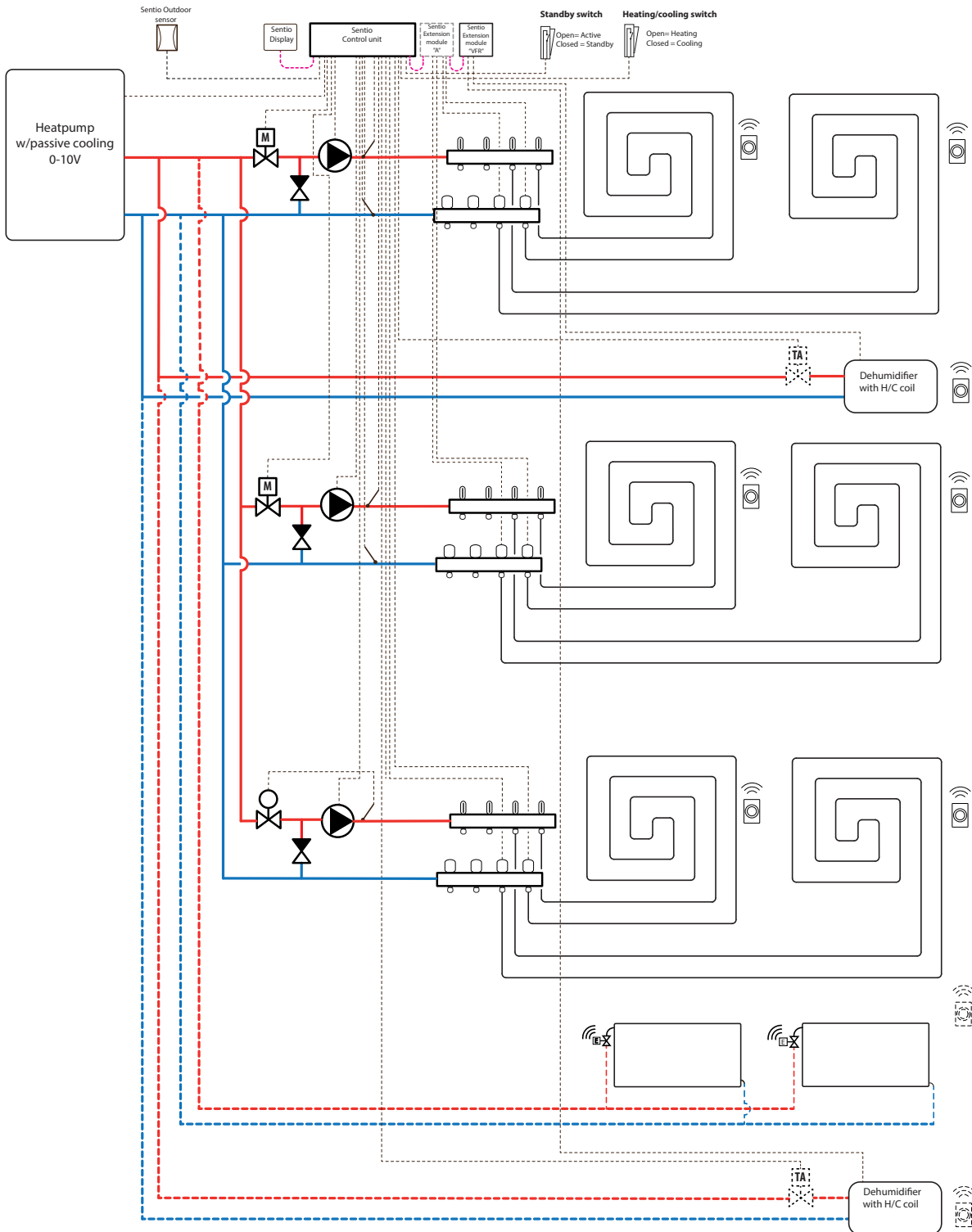

Wiring for profile 4.1.4

Depending on the heat source wiring can be done according to the drawings found in paragraphs 4.6 to 4.8. For connecting dehumidifiers follow instructions in paragraph 3.6.

Setup of profile 4.1.4

To be able to set/adjust the settings for the Sentio system you need either the Sentio touch screen or the Sentio connection cable for PC.

In order to use profile 4.1.4 use the touch screen or the PC tool via the connection cable and follow the steps below:

- Change the profile in the touch screen or in the PC tool by going via the start screen to the menu [System](#) | [Installer settings](#) | [Hardware profile](#) | [Change profile](#), select '4.1.4 Dehumidifier, any source, 2 ITC, 1HCC, manual H/C change-over'. The system will restart and load profile 4.1.4

Before profile 4.1.4 can be used some specific settings must be set. As more heat/cooling sources are possible to be set in these profiles not all required settings are applicable to your system. With the great flexibility this profile has to offer, keep the layout of your system in mind when setting the parameters. Please follow the steps below to set the required parameters:

In case a 0-10V modulating heat source is connected, the desired heat curve has to be set and the specific voltage output for analog signal corrected, this is by default 0V at 0% and 10V at 100%.

- Change the heat-curve settings in the touch screen or in the PC tool by going to the menu [System](#) | [Functions](#) | [Heating/cooling circuits](#) | [Heating circuit 1](#) | [Heat curve settings](#). Please select the type of heat curve you want to use or setup your own curve, by selecting "Manual".
- Set the analog signal in the touch screen or the PC tool by going to the menu [System](#) | [Installer settings](#) | [Hardware profile](#) | [Configure in- and outputs](#) | [Analog outputs](#).
- At the row "Temperature threshold" you can setup the outdoor temperature where the Central Control Unit stops the heat demand to the source.
- Specify the lowest voltage the boiler can accept and at which inlet temperature this voltage represents.
- Specify the highest voltage the boiler can accept and at which temperature this voltage represents.

- Specify the desired start and stop delays for the heat source.
- Select the type of servo connected in the touch screen or in the PC tool by going via the start screen to the menu [System](#) | [Installer settings](#) | [Hardware profile](#) | [Configure required inputs and output](#) | [Servos](#) | [ITC Servo](#). By default, a 3-point servo is selected. If a 0-10V servo is used, check if the selected mode fits the characteristic of the connected servo.

To setup the dehumidifier unit connect the following steps must be done. The steps are depended on the dehumidifier's water supply connection and its location in the building. The correct water source must be set in the commissioning tool, an error will appear if this is not set.

- Set the water source in the touch screen or PC tool by going to the menu [System](#) | [Functions](#) | [Dehumidifier 1 \(4\)](#) | [Heating/cooling water source](#) and select the circuit that the dehumidifier is connected to. If there are multiple dehumidifiers connected this setting must be done for each of them.

When a dehumidifier is enrolled as "manual output assignment" (outdoor of the pre-set function of the extension unit) outputs must be assigned manually, these can be unused voltage free relays on the extension unit or unused outputs of the Central Control Unit. For any dehumidifier an extra pump and external thermal actuator(s) to control the water flow to the unit can be assigned.

- Assign outputs manually in the touch screen or PC tool by going to the menu [System](#) | [Functions](#) | [Dehumidifier 1 \(4\)](#) | [Output assignment](#) | [Drying/Thermal Integration demand](#) and assign the desired output.
- Assign an extra pump in the touch screen or PC tool by going to the menu [System](#) | [Functions](#) | [Dehumidifier 1 \(4\)](#) | [Output assignment](#) | [Pump demand \(optional\)](#) and select the output to which the extra pump is connected.
- Assign an external thermal actuator(EXTA) in the touch screen or PC tool by going to the menu [System](#) | [Functions](#) | [Dehumidifier 1 \(4\)](#) | [Output assignment](#) | [EXTA demand \(optional\)](#) and select the output to which the EXTA is connected.

By default, the filter lifetime of the dehumidifier is set to 2000 hours, if this does not correspond with the filter used in the connected dehumidifier this time can be adjusted.

- Change the filter time in the touch screen or PC tool by going to the menu [Systems | Functions | Dehumidifier 1 \(4\) | Air filter Management](#) and change the lifetime to the value fitting the selected filter type.

Each of the dehumidifier units must be assigned to the rooms that they are connected to. The unit can be connected to one room or multiple rooms, depending on how the unit is placed in the building.

- Assign rooms to the dehumidifier in the touch screen or PC tool by going to the menu [System | Functions | Dehumidifier 1 \(4\) | Room assignment](#) and select the rooms you want to connect to this unit.

Please repeat the steps above for the other dehumidifier units.

If you have rooms with both underfloor heating/cooling and Smart radiator thermostats, the two can have the same or different supply circuits, re-assign the underfloor outputs and radiators to fit your system. By default, both the underfloor and radiators are assigned to ITC 1 (pump 1). In rooms with both underfloor heating and radiators, the two can have the same or different supply circuits, re-assign the underfloor and radiators to fit your system. To re-assign outputs to a different supply circuit they will first need to be removed from the default circuit.

- Assign the room's outputs in the touch screen or PC tool by going to menu [System | Functions | ITC 1 | Room assignment for this circuit](#) and select the rooms you want to control the pump.
- Assign rooms to the Heating/cooling circuit in the touch screen or the PC tool by going to the menu [System | Functions | HCC 1 | Room assignment for this circuit](#). Select the rooms you want connected to the circuit and pump 2.
- Assign radiators to the H/C source in the touch screen or PC tool by going to menu [System | Functions | H/C source | Room assignment](#) and select the room's radiators that are connected directly to the heating/cooling source.

Personal Preference settings of profile 4.1.4

By default, the start signal to the source (boiler/heat pump) is delayed by 5 minutes to allow the thermal actuators to open, before the source starts. This default time can be adjusted to shorten or lengthen this delay with respect to the minimum required opening time for thermal actuators.

Change the source (boiler/heat pump) start delay in the touch screen or in the PC tool by going to the menu [System | Installer settings | Hardware profile | Configure required inputs and output | Voltage free relays | Boiler/ Heat pump](#) and change the "Start delay" value to the value you need.

Profile 4.1.4 protects the connected rooms with a humidity measurement against condensation. When the difference between the inlet temperature and the calculated dewpoint gets too small, the inlet temperature will be raised or blocked until there is no more risk of condensation. This difference can be changed, however lowering this value increases the risk of condensation, while increasing this value might lower the cooling efficiency.

- Adjust the default safety margin and minimum outdoor temperature in the touch screen or in the PC tool by going to the menu [Programs | Winter & Summer mode | Cooling settings](#) and change the "Room dew point band" to the preferred value.

When using an outdoor temperature sensor the outdoor temperature cut-off will be active, this will stop the system from unnecessary heating or cooling when the outdoor temperature reach a certain threshold.

- Change the outdoor temperature cut-off in the touch screen or the PC tool by going to the menu [Programs | Winter & Summer mode | Heating settings/ Cooling settings](#) and set a maximum and minimum outdoor temperature.

High temperature cut-off is always active for the ITC, the limit can be changed to fit your specific system. This limit stops the heat-flow if the maximum inlet temperature is exceeded by the set value to protect the underfloor heating circuit.

- Adjust the High temperature cut-off in the touch screen or the PC tool by going to the menu [System | Functions | ITC 1\(2\) / HCC | Safety](#), set the desired Cut-Off temperature and the delay, expressed in K.s (Kelvin/second).

The High Temperature Cut-Off must be set for each manifold separately.

The "Frost protection temperature" is used to protect the system from freezing. This setting keeps the minimum temperature above the set value to prevent freezing. If the temperature drops below the minimum, the system will ask for a temporary heat demand which will pump water around and create a flow through the system protecting it from freezing.

- Adjust frost protection settings in the touch screen or the PC tool by going to the menu [System | Functions | ITC | Safety](#). And adjust the "Frost protection temperature" to personal preference.

By default, the start signal to the mixing pump is delayed by 5 minutes, to allow the thermal actuators to open, before the mixing pump(s) starts.

- Adjust the pump delay in the touch screen or the PC tool by going to the menu [System | Installer settings | Hardware profile | Configure required inputs and output | Relays | Pump 1 \(2\)](#) and change the "Start delay" value to the preferred value. This has to be set for each pump separately.

By default, the heat curve for the Inlet Temperature Controller (ITC) mixing circuit is set with a slope of 0.6.

- Change the heat curve in the touch screen or the PC tool by going to the menu [System | Functions | ITC | Heat curve settings | Heat curve type](#). Select between different ways to set the heat curve:

Manual: Set the desired heating curve yourself.

Underfloor: Fixed heating curve with a slope of 0.6, optimized for underfloor heating systems.

Radiators: Fixed heating curve with a slope of 1.2.

By default, a maximum return temperature limit from the mixing circuit is set. This can be changed or switched off.

- Find the return temperature limiter settings in the touch screen or the PC tool by going to the menu [System | Functions | ITC | Return temperature limiter](#). Here you can select which kind of return restriction you want to use:

Off: There is no restriction on the return temperature.

Maximum: Ensures that the return temperature does not exceed the set maximum temperature.

Minimum: Ensures that the return temperature does not fall below the set minimum temperature.

When a dehumidifier unit is connected to the system, there are specific settings per unit and per room. For the unit it is possible to set the allowed supply temperature. Per room it is possible to set the desired relative humidity and control parameters for both drying and thermal integration.

- Change the units drying/integration settings in the touch screen or the PC-tool by going to the menu [System | Functions | Dehumidifier 1 \(4\) | Drying settings/ Thermal integration Settings](#). Set the supply temperatures as desired.

If you have more than one dehumidifier, this setting has to be done for each unit. However, the limitations to the supply temperature can affect all units connected to the same heating/cooling circuit.

- Change the rooms drying/integration settings in the touch screen or the PC-tool by going to the menu [Info | Room | Settings | Drying settings/ Thermal integration Settings](#).

In case a room is not allowed to cool. This can be switched off, the room will not open its outputs when the system is in cooling mode.

- Change the allowed cooling in a room in the touch screen or the PC-tool by going to the menu [Info | Room | Settings | Summer Mode | Allow cooling](#). Switch the setting to OFF if the room is not allowed to cool.

NOTE: Because all sensor inputs (T1 – T5) are occupied in profile 4.1.4, the outdoor temperature cannot be measured by an outdoor thermometer and will have to be measured by a wired or wireless outdoor temperature sensor.

6. GO

When using zone-control in residential applications each zone can be controlled via the room thermostat in that particular room. An alternative is to control each room from a distance (so no need to be present in the room) via the Wavin Sentio app. Make sure the Sentio system is up-to-date by using the auto-update function after the installation is complete.

6.1. Using the Sentio App

Go to the Google Play or iOS App Store and download the Sentio app. After the registration process the app is ready for use.

The CCU only has the option for a wired internet connection via the LAN port. For a Wi-Fi connection an external connection point must be added. Wavin is recommending the TP-Link repeater (Art. 4065599) with a dedicated connection manual found in the appendix 8.6.

After installing and commissioning of the total system the registration of the CCU to the app can be done and the app can be configured based upon the requirements of the user. The User can decide to grant access to the CCU to other people as well. Granting access to other people also implies that more than one person simultaneously can adjust the required settings. The Sentio app enables you to take control of your Sentio system and to adjust the settings.

The features are beyond the settings that can be made via the room thermostat and are adapted to the daily use demand. Installer-level changes to the system can only be made via the touch screen or the PC tool.

At the start screen you can add widgets for an easy access and adaption of the different rooms. Each user can select different rooms, so that you have an easy overview and access to the rooms that are important for you. For a fast temperature choice three comfort levels are predefined in the app. Eco (18°C), comfort (21°C) and extra-comfort (23°C). In the settings you can adapt the preset temperatures according to your demand.

The room thermostats can be locked/unlocked via the touch screen or app. Then set temperature cannot be changed by using the room thermostats. With the app the user is allowed to set schedules, chose temporary modes e.g. for holiday and adapt the pre-set temperatures for the system. These functions are also available for the installer using the touch screen.

Adaptive mode

In the APP, under room settings, it is possible to enable adaptive mode. When a schedule is active this mode will collect data on the heating capability of the room over a period of two weeks. After these two weeks heating will start heating some minutes before there is a setpoint change in the schedule and reach the desired temperature just in time.

Time-zone selection

When first connecting the mobile APP to an installed Sentio system the time-zone will be compared between the unit and APP, if this is not the same there will be a notification alerting the user he/she might want to set the local time-zone. This can be done in the APP settings.

6.2 Auto-update functionality

The Wavin Sentio system is ever evolving. New features are constantly being added. To access the new features a firmware update is required, the system will continue working as is if not updated. It is possible that components such as room thermostats or room sensors contain older firmware versions, the control unit will automatically check all components and will raise a warning if any should be updated to avoid compatibility issues due to version mismatches.

Updating from file

The system can be updated by inserting a SD card with the firmware file into the touch screen commissioning tool. By pressing the buttons on the Central Control Unit (CCU) twice to the left, to the network LED, the file will be loaded on the unit and the update can be started afterwards via the touch screen by going to [System | Actions | Update | Automatic update](#) or buttons on the CCU to trigger the auto-update function.

For the firmware file please contact your local Wavin support via www.Wavin.com/Sentio.

Auto-update functionality

CCUs with the firmware TM60006.2 current or later version will be able to update automatically. To do this, the CCU has to be connected to the internet. If a new update is available, there will be a notification on the Sentio App. In the app go to [Sentio app | Settings | Status and updates](#). Another way to start an update is to navigate via the arrow buttons to the network LED on the CCU and press the “Enter” button, if the LED turns steady blue press the “Enter” button again to start the update.

The CCU, when connected to the internet, will check for new updates once every month. The updates will be downloaded onto the memory of the CCU and wait for the user to start the update. All components connected to the CCU will be checked and updated to the latest version when the update-run is started by the user. If in a rare case the update fails, CCU or components will be set back to the old firmware version and await a new start of the update.

Offline auto-update

Every unit leaving the factory will have a package of the latest firmware already downloaded. In case the unit is not connected to the internet it will still be possible to start the auto-update function to check and update connected components (e.g. room thermostats) just to make sure everything is at the latest version.



- During the update limited functionalities of the system are available.
- Do not do any changes in the set-up of the Sentio system during updating.

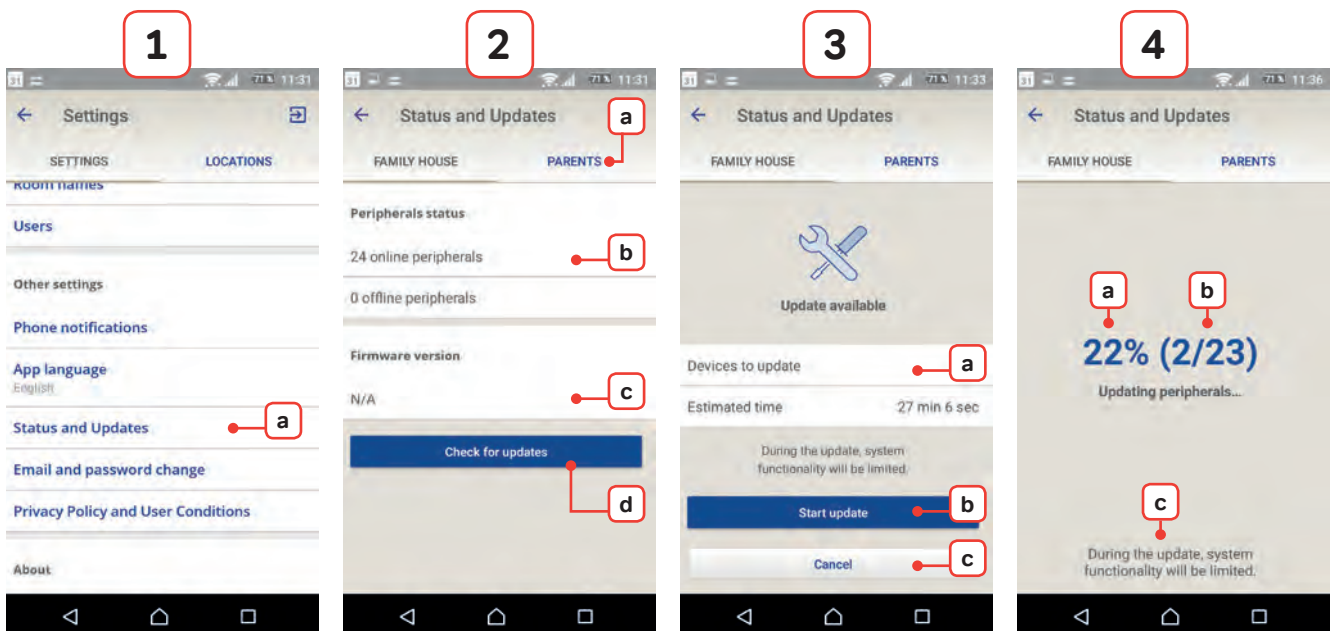

Screenshots of Sentio app on Android.

1) Settings

- a) Find 'Status and Updates' in the settings tab.

2) Status and Updates + pop-up peripheral offline

- a) Select the location you want to check for updates.
- b) Here you see how many peripherals are connected.
Only online peripherals can and will be checked for updates.
- c) Here you see the firmware version already downloaded on to the CCU.
- d) Press the button 'Check for updates' to start checking for updates. If any peripherals are offline a pop-up will appear, warning the user that offline peripherals will not be checked, this does not hinder the checking of the other devices.
CCU network LED will flash blue when checking for updates.

3) Checking for updates/update found

If there is a new update it gets automatically downloaded to the CCU.

- a) Number of devices with available update and estimated time updating all devices.
- b) To start the update press the 'Start update' button.
First the CCU will update and restart, then all the other peripherals for which an update is available will be updated.
- c) To cancel the update, press cancel.
CCU network LED will light up steady blue when updates are found

If an update for the CCU starts, the CCU will restart: Output LEDs flashing yellow and decrease from right to left. After all output LEDs are off, Power LED lights steady red and Error LED flash fast yellow. CCU is now updating: Output LEDs flash yellow and move from left to right.

4) Update running

- a) Status of the current update running.
- b) Number of peripherals left to update.
- c) Keep in mind that the system loses some functionalities during updating.
While waiting the set temperature cannot be changed for some rooms.

6.3. Maintenance

The Sentio Central Control Unit for underfloor heating/cooling requires no planned maintenance. The control unit, extension units and room thermostats/sensors can be cleaned with a damp cloth. Do not use cleaning products!

It is important to ensure that the control unit and extension units are not blocked/covered by anything. This in order to ensure proper cooling of the units and to avoid damaging. Furthermore, to ensure a normal functioning of the temperature and humidity sensor the opening of the room thermostats/sensors on the bottom side shall not be covered.

Periodic activation (preventive maintenance)

If a component has not been activated for a while (by default 1 week), the output(s), circulation pump(s), servo(s) and Smart Radiator Thermostat(s) will be activated for to prevent jamming. By default outputs will be opened for 10 minutes, pumps for 5 minutes and servos and Smart Radiator Thermostats will do one full open – close movement. This periodic activation will take place once per week unless set differently. The actuator channel LED(s) on the CCU will flash white, indicating that the periodic activation is active. Changes to the output's periodic activation can be made in the touch screen or PC tool by going to the menu [Info | Room | Associated outputs | Output](#).

The weekly day and time for periodic activation can be set to a specific time in the menu [System | Installer settings | Periodic activation](#), by default this is set for Wednesday at 9:00 AM.

Frost Protection (building protection)

In case the outside temperature, room temperature or supply temperature is close to freezing point the frost protection is activated. This function prevents the system from freezing by activating heating for 15 minutes every hour. In systems with Inlet Temperature Control (ITC) the heating will be controlled to the minimum required inlet temperature to prevent freezing. Frost Protection will also be activated if the connection with a room thermostat/sensor or Smart Radiator Thermostat has been lost.

If the CCU's backup battery runs out or the fuse blows, this can be easily replaced. First remove power from the CCU, then remove the front panel. At the back of the front plate you find the CR2032 battery in the middle and on the side, inside the box 'FUSE 5x20', the broken fuse. The Sentio comes with a spare fuse of type 'T1.6A/250V size 5 x 20'.

Air Filter Maintenance

For systems with a dehumidifier the Sentio has a build in filter lifetime clock. When the dehumidifier has been active for (default) 2000 hours, the dehumidifier will be put inactive until its air filter has been replaced. To replace the air filter, follow the instructions of the dehumidifier unit. Once the filter has been replaced the filter lifetime can be reset in the touch screen or PC tool by going to menu [Functions | Dehumidifier | Air filter management](#).

Temporary Remote Access

Using the Sentio Smart Connect PC program it is possible to connect remotely to a Sentio system connected to the internet. With this tool it is possible to see the system errors and make changes where needed. The interface is the identical to as the commissioning touch screen, so no need to learn a new tool.

A connection can only be made with the end-user's permission. Permission can be given via the APP, touch screen or by holding both the left and right button at the same time for 3 seconds. The channel lights will light up forming an access code that can be used to make a temporary remote connection for one day. In the Wavin Sentio APP the end-user can prolong the time allowed to connect or stop the remote connection.

For this function the Central Control unit needs to be at firmware TM60014 or higher, a quick update might be needed before connecting.

In the APP go to [Settings | Temporary access management | Create access](#) In the touch screen go to [System | Temporary remote access](#)

6.4. Commissioning Touch screen

Help screens

For some direct information about the current screen help is available by clicking the top right button in the screen. This will show help for each button of the screen for whatever screen you are currently on. If a language does not have the help screens available then English will be used instead.

Test mode

With the system up and running the test mode can be used to check each output if it is functioning correctly. This mode can be used after commissioning to see if the boiler/heat pump is switched on correctly or the pumps will run smoothly for example. Test mode can be found for each output in the menu [System](#) | [Installer settings](#) | [Hardware profile](#) | [configure required inputs and outputs](#). When there are doubts that a connection is not working properly the test mode can be a handy tool in finding bad connections.

Installer level PIN

When a touch screen is left at the location it is advised to set a PIN code to block access to critical installer settings. A PIN can be set in the menu [System](#) | [Installer settings](#) | [Change PIN code](#) and will block anyone trying to go into the menu 'Installer settings' and (accidentally) change settings.

NOTE: Please make sure to remember the PIN code, as it is not possible to recover this PIN. To reset it the whole system will have to be reset.

Room status

Under Room info it is possible to see the current status of the room; Heating/cooling or blocked. The status of the various sources in the room is expressed in icons, as underfloor heating and radiators aren't always on at the same time for example. Only the status icons that apply to the current situation are shown. If an icon is missing, the source is probably not correctly connected or set. To see a list of all the status icons see paragraph 8.7.

Room Schedule

A room schedule can be set in the room info under the menu 'Room schedule'. When there is no internet to set the schedule via the App this is where a schedule can be set after commissioning. A schedule is set by setting Comfort/Extra comfort intervals for time when the system should be heating or cooling to the desired comfort temperatures, outside these intervals the system room will be set to Eco mode. Day schedules can be copied to other days and room schedules can be copied to other rooms.

Remote access password

When something is not working correctly and needs maintenance, remote maintenance can be used to solve most issues. This can be done by setting a password and communicating this password to Wavin support to connect remotely. Development is still ongoing to improve and expand remote maintenance for installers.

The remote access password can be found in menu [System](#) | [Installer settings](#) | [Remote access management](#).

6.5. Sentio Modbus

Sentio can be integrated into Building Management Systems (BMS) using a Modbus connection. Sentio's RJ45 port A can be set to Modbus RTU communication using the touch screen. It is not possible for an external system to take over Sentio's thermostats or outputs, these will always be controlled by Sentio's secure communication.

The Modbus master RTU function can be activated on port A in the touch screen and can only be used to connect Wavin Ventiza Ventilation units. With the Modbus Master function active it is no longer possible to use Modbus RTU Slave for BMS. Sentio is not a BMS itself, so can't integrate other external devices over Modbus.

Modbus TCP/IP Slave is possible in firmware TM60014 and higher. Modbus TCP uses the wired ethernet connection to make a connection to the BMS. Registers are all the same as for Modbus RTU. Both TCP Slave and the Modbus Master over RTU can be used at the same time. Sentio uses DHCP networking configuration and does not have the possibility to manually set a static IP address on the unit via the touch screen.

For installation details and Sentio's Modbus registers see the dedicated Modbus Manual found in Appendix 8.8.

7. Copyright & Disclaimer

This technical handbook is intended for information purposes only. No rights can be derived from the content of this technical handbook.

All intellectual property rights in respect of this technical handbook shall remain with Wavin, and you shall not obtain any right in Wavin's IPR. Wavin's IPR in general and specifically Wavin's IPR on this technical handbook may not be used, copied or made available to third parties by you for any other purpose without Wavin's express prior written consent.

You shall comply with all copyright laws and regulations applicable. Furthermore, you shall inform Wavin immediately and in full of any actual, expected or envisaged infringement of Wavin's IPR that comes to your attention.

When designing with, installing and/or using the Wavin Sentio system, you should fully comply with:

- ⦿ the safety measures as set out in this technical handbook or otherwise communicated with you in regard to (the installation and/or use of) the Wavin Sentio system;
- ⦿ all applicable laws and regulations of any jurisdiction regarding safety;
- ⦿ the installation instructions provided by Wavin and other applicable instructions;
- ⦿ the installation instructions provided by 3rd Parties of components used in combination with the Wavin Sentio system.

Furthermore, you should take care that the Wavin Sentio system, the components thereof and the components to which the Wavin Sentio system shall be connected are:

- a) Stored in such a way that they are not exposed to e.g. moisture, temperature, pressure, voltages, etc. that are outside the allowed range/tolerances/limits mentioned on the products via stickers/labels/printing or stated in any manual/instruction/video as supplied by Wavin
- b) Checked/inspected before they are installed and put into operation in order to judge if they do not show signs of damage or mishandling of any kind
- c) Designed, selected, installed and commissioned by a competent and licensed designer and installer who works in full compliance with up-to-date technical manuals, installations instructions provided by Wavin (available at the time of installation) as well as in

compliance with all applicable building and plumbing regulations, codes and other requirements and guidelines

- d) Used only in combination with compatible products approved and specified by Wavin suitable for the application being heating/cooling
- e) Used only in combination with hydronic systems that are designed and installed according to the state of art application guidelines
- f) Not combined/connected to or used in any other way with non-Wavin products, parts or components except for those approved or specified by Wavin
- g) Located, installed and commissioned and used during its lifetime without being relocated from this original installation location, modified, repaired or changed.

Wavin has to its best knowledge secured that the content of this technical handbook is accurate but does not issue any guaranty or warranty in respect thereof. In case you discover that the content is not correct in any way, please notify Wavin immediately.

Wavin reserves the right to modify the content of this manual. Furthermore, Wavin reserves the right to discontinue manufacturing of the Wavin Sentio system described at any time without prior notice or obligation.

This technical handbook does not give any guaranty or warranty (expressed or implied) in general, nor regarding in specific the conformity of the Wavin Sentio system, the quality of the Wavin Sentio system and any IP rights. All liability is excluded to the fullest extent permitted by law. Wavin shall under no circumstances be liable for pure economic loss, loss of profits, loss of contracts, loss of business, depletion of goodwill and similar loss in each case whether direct, indirect or consequential, and even if foreseeable by Wavin, or any claims for consequential compensation whatsoever (howsoever caused) which arise out of or in connection with the Wavin Sentio system.

Nothing in this technical handbook excludes or limits the liability of Wavin for death or personal injury caused by Wavin's negligence, fraud or fraudulent misrepresentation and/or any other matter in which it would be illegal for Wavin to exclude or attempt to exclude its liability. This disclaimer and any provisions in the technical handbook do not limit the rights of consumers insofar as pursuant to mandatory rules of law.

8. Appendix

8.1. Frequently Asked Questions

Before you view this overview, it is recommended that you read this installation manual thoroughly. Read in particular the above paragraph on maintenance and view the LED lights of the control unit on the basis of the overview of the LED lights in 'User Guide – general'. You may find an explanation for the symptom without further investigation.

SYMPTOM	PROBLEM	SOLUTION
<p>The LED light on the control unit of a channel shows overload.</p> <p>Flashing red fast.</p>	<p>More than the max 2 thermo-actuators or other device connected to the output</p> <p>The power consumption of the device is too high</p>	<ul style="list-style-type: none"> ④ The connected device consumes too much power. Connect max. 2 thermal actuator to separate outputs of the CCU and max. 1 thermal actuator per channel of the EU-A. ④ Check that the connected device operates with 24 V/DC with a load of no more than 1W/0.4 A. Replace the connected thermo-actuator in case of bad/damaged/broken wiring.
<p>The LED display of the thermostat/sensor does not 'awake' at touching.</p> <p>Not responding.</p>	<p>No input of that particular room/zone to the control unit.</p> <p>Wrong type of BUS cable is used or BUS cable connected in a wrong way.</p> <p>The batteries are empty for the wireless room thermostats/sensors</p>	<ul style="list-style-type: none"> ④ Fault in wired connection between the control unit and the wired room thermostat/sensor. ④ Check for correct connections at the control unit and the wired room thermostat/sensor, and check if the wiring is of the correct type and in good condition (not twisted or damaged) and well connected to the control/extension unit. ④ Replace the batteries.
<p>Connection with thermostat/sensor lost / temporary interrupted.</p>	<p>Fault in wired connection between the control unit and the room thermostat/sensor.</p> <p>Use of incorrect cable type.</p> <p>Weak wireless signal.</p>	<ul style="list-style-type: none"> ④ Check for correct connections at the control unit and the room thermostat/sensor and check if the cable is connected correctly. ④ Check for continuity from one end of the wire to the other end and make sure there is no short circuit between individual wires. ④ Check that the room thermostat or control unit is not mounted on a metal surface or housing. ④ Check for non-certified wireless products within the range of their control system. ④ In case situation continues an external antenna is available to improve the signal strength.

SYMPTOM	PROBLEM	SOLUTION
Room thermostat/sensor cannot be enrolled/connected to the control unit.	<p>The control unit does not receive the link signal.</p> <p>The room thermostat does not send a link signal.</p>	<ul style="list-style-type: none"> ④ Check that the LED light of the output channel indicates that the control unit is ready to be paired (paragraph 4.1.1). ④ Place the batteries inside the wireless thermostat/sensor, check correct battery position and start enrolling proves (paragraph 4.4). ④ See symptom “Connection with thermostat lost / temporarily interrupted”
One or more rooms become overheated.	Room thermostats/sensors control the wrong outputs.	<ul style="list-style-type: none"> ④ Reset incorrectly linked outputs and connect them to the correct room thermostat. ④ Label the output on the manifold and check corresponding thermostats/sensors in the room.
Thermostat is showing a “no entry sign”	Thermostat is in synchronization mode	<ul style="list-style-type: none"> ④ Wait a little bit for the thermostats to initialize (paragraph 8.5)
Pump is not starting	<p>Pump delay is active</p> <p>Pump 2 is not assigned</p>	<ul style="list-style-type: none"> ④ Pump will be delayed so outputs can open first. Change pump delay in LCD commissioning tool System Installer Settings Hardware profile Configure Outputs ④ Assign rooms and outputs to pump 2 (default pump 1) in LCD commissioning tool System Functions HCC/ITC Room Assignment
The Smart Radiator Thermostat is giving an error “installation incorrect” ?	Calibration function did not detect valve	<ul style="list-style-type: none"> ④ Make sure the the Smart Radiator Thermostat is connected to the radiator valve and re-insert batteries to restart the calibration function.
My control unit is showing white LEDs during installation?	First Opening of Actuators function is active	<ul style="list-style-type: none"> ④ This functions makes sure the actuators will close properly. Our actuators have an easy to install function, they are delivered half open, to close they will need to fully open first. Commissioning of the system can continue as normal, the FOA function will take about 10-20min. After that testing can be done if needed. There is no way to switch off this function. (Paragraph 4.1)

SYMPTOM	PROBLEM	SOLUTION
Cooling blocked / room LED blinking blue on the control unit?	Dew point protection is active. Inlet sensor missing, cooling not protected.	<ul style="list-style-type: none"> In cooling mode Sentio is protected against risk of condensation. Dew point is calculated per room and compared to the inlet temperature or floor temperature. If the inlet temperature would go below the dew point cooling will be blocked to avoid condensation. For cooling mode there is always a inlet sensor needed to ensure the system will be safe. The function cannot be switched off but the safety margin can be changed in the LCD commissioning tool: Programs Summer/winter mode Cooling settings
The Control unit is showing purple room LED?	Room with only radiator control using Smart Radiator Thermostats	<ul style="list-style-type: none"> Room only has SRT (no actuator, PID control), there is no clear ON/OFF control. The radiators can be a bit open and still feel warm, although it is not expected to be fully heating. (Paragraph 4.4)
Warning message saying "Incompatible periphery detected please update software"	Component firmware version is lower than control unit firmware version	<ul style="list-style-type: none"> Control unit should have firmware available to update all components to the same firmware version to avoid any unexpected issues. Activate the auto-update function to update components where needed, even without internet connection. (Paragraph 6.2)

QUESTION	INFO	SOLUTION
Can Sentio work via an BMS? External thermostats via modbus?	Modbus Manual in Appendix 8.8.	<ul style="list-style-type: none"> • Sentio can be connected as slave to a Building Management System via Modbus RTU and TCP/IP. The Sentio system itself will still be in charge of the underfloor heating. It is not possible for the BMS to take over Sentio's outputs, that would take away the functionality of Sentio.
Does the Smart Radiator Thermostat (SRT) need a room thermostat?	SRT Manual in Appendix 8.4	<ul style="list-style-type: none"> • Depends on the situation, the Smart Radiator Thermostat can work stand alone but requires the APP to set the temperature. In cases where it cannot accurately estimate the temperature a room thermostat can be added. When both are added to the same room the Smart Radiator Thermostat will automatically switch its controll to the room thermostat.
How do I rename rooms?		<ul style="list-style-type: none"> • Renaming rooms in the commisioning touch screen makes it easier for future maintenace and remembering where UFH loops go. The set name will be imported to the APP. The end user can change the display name of the room as desired. Often there are some question marks when changing the name in the APP, it will not update the display name, this is because the two are seperate names, to update the names the APP widgets will need to be removed and re-added with the new name.
What is the maximum number of components that can be added into one Sentio system?	Paragraph 3.0	<ul style="list-style-type: none"> • See the list for maximum components in paragraph 3.0 or the Sentio Quick Guide.

8.2. Sentio Room Thermostat

Via the room thermostat different settings can be made and information about the room are provided.

1. Room settings

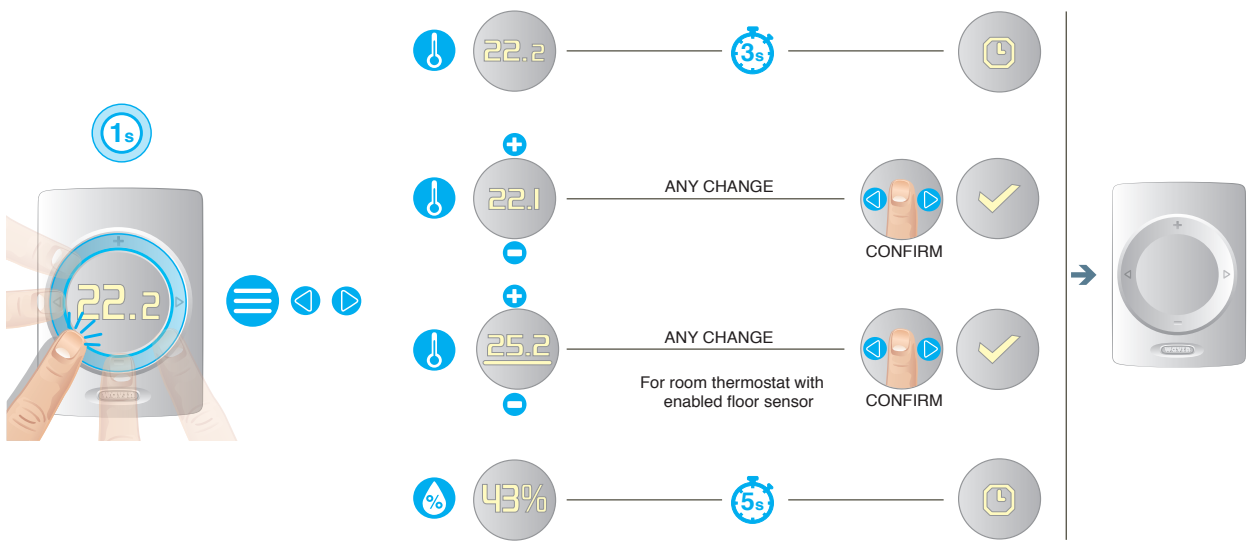

2. Room comfort settings

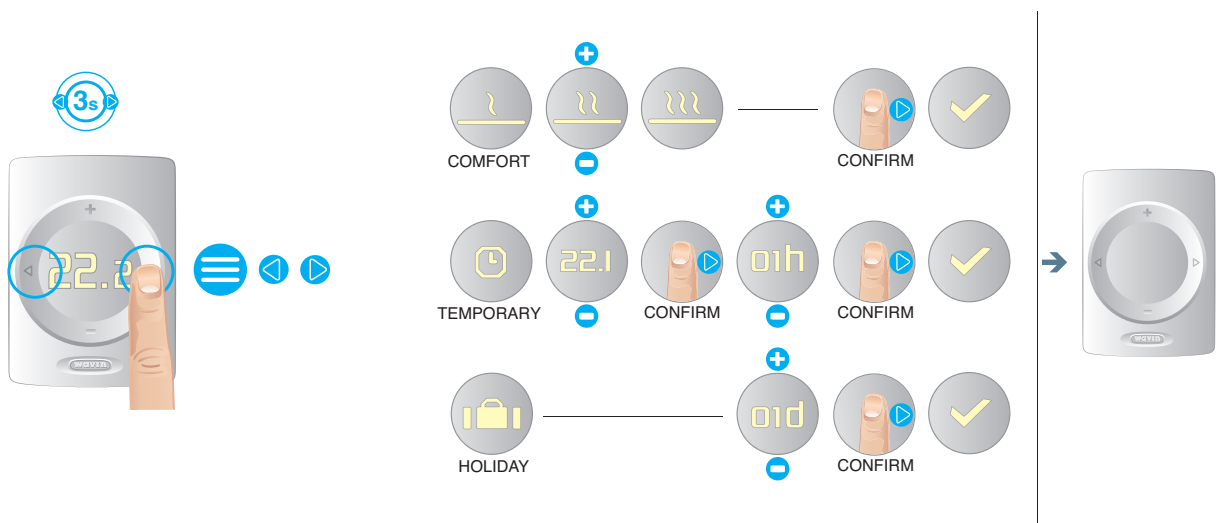

3. Advanced settings

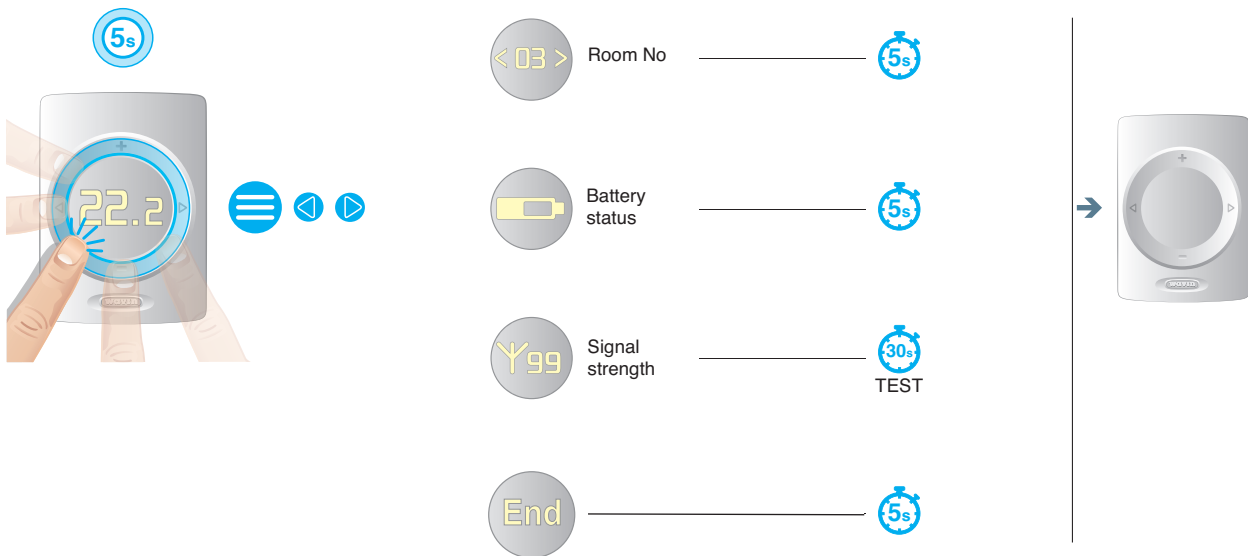

4. Lock | Unlock

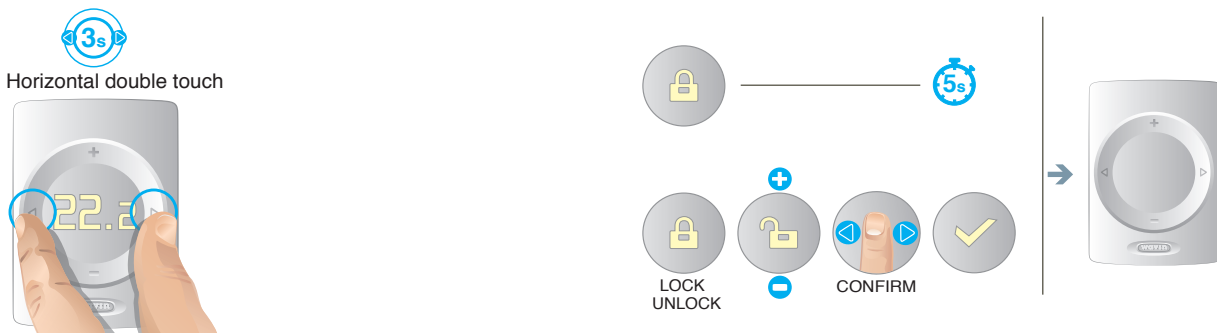

5. Warning

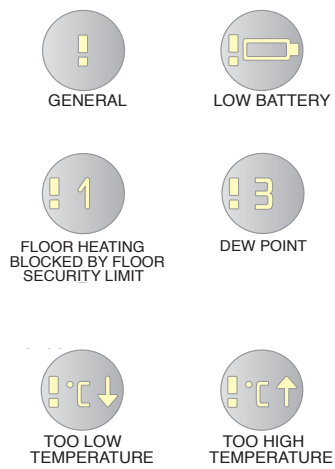

→ See
chapter
8.5

6. Error



FLASHING LED

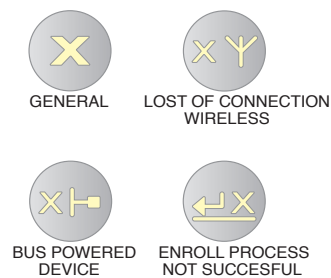

→ See
chapter
8.5

7a. How to replace the batteries | Wall mounted | wireless

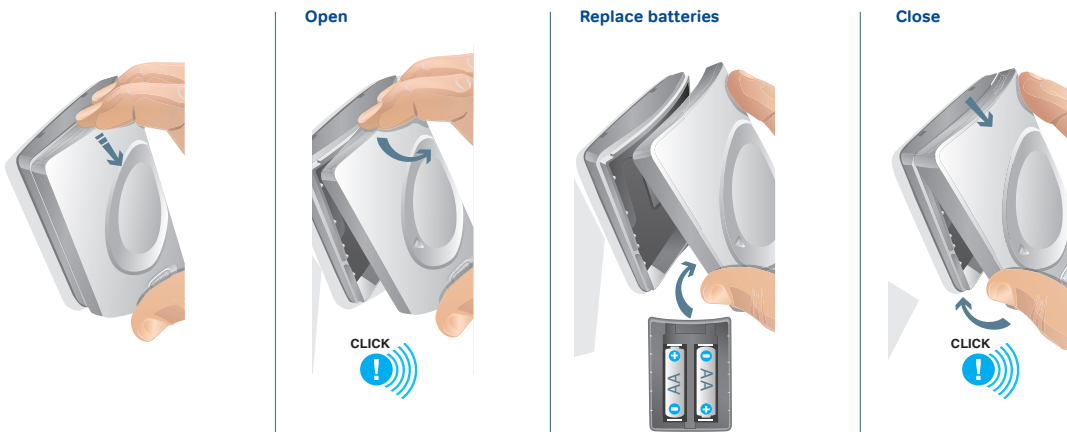

7b. How to replace the batteries | Hand Held | wireless

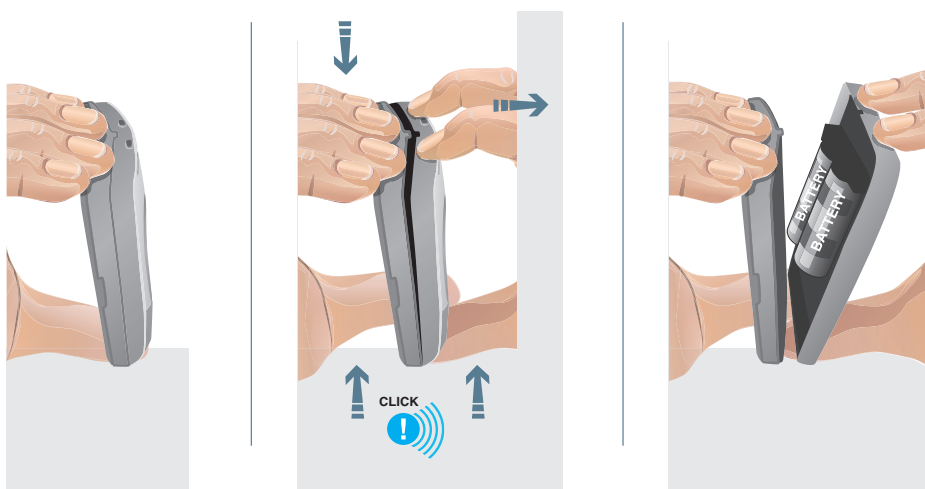

8.3. User Manual Sentio Sensor

1. Warning



**See
chapter
8.5**

2. Error



FLASHING LED



**See
chapter
8.5**

3a. How to replace the batteries | Wall mounted | wireless 📶

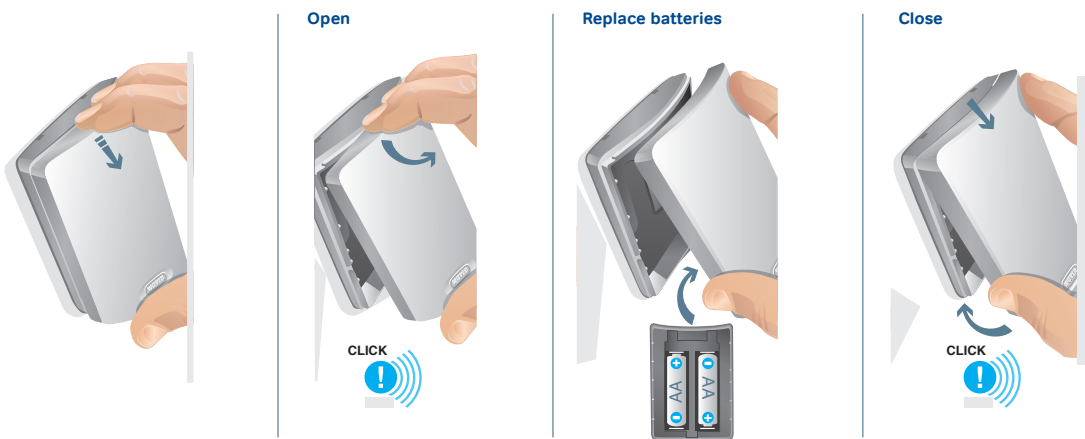

3b. How to replace the batteries | Hand Held | wireless 📶

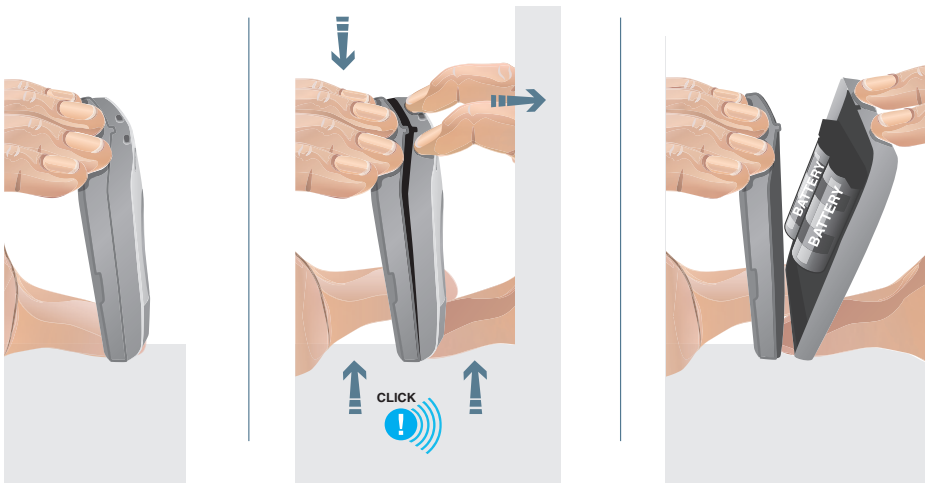

8.4. User Manual Smart Radiator Thermostat

Preparation

System Requirements

For controlling Smart Radiator Thermostats a Central Control Unit is needed. For instructions on installing these products please see the Technical Handbook at www.wavin.com/Sentio.

Limitations

	Max
⊕ Rooms available on the Central Control unit	8
⊕ Rooms total (with extension module or via commissioning tool)	24
⊕ Number of thermostats and sensors	24
⊕ Smart Radiator Thermostats	16

Compatibility

M28 and M30 valves	Art. 4063805
RA valves	Art. 4063804

Technical Information

Radio frequency	868.5 MHz
Power supply	3 x AA Alkaline 1.5V Battery
Battery life	Up to 3 years
Dimensions	L = 85 mm, \varnothing = 50 mm
IP protection	IP30
Operation environment	0°C - 40°C
Ambient humidity	Humidity 5 - 95%
Storage temperature	-10°C - 40°C
Valve stroke	Max. 4.5 mm

Compliance

Installation must comply to (local) guidance and regulation. The Smart Radiator Thermostat is developed in Europe and is CE approved according to following EU directives:

2014/53/EU, 2014/35/EU, 2014/30/EU and 2011/65/EU

Safety: ETSI EN 300 220-1 V3.1.1:2017; ETSI EN 300 220-2 V3.2.1:2018
EN 60730-1:2011; EN 60730-2-8 ed
2:2002/A1; EN 55016-2-3 ed.4:2017; EN 55032 ed 2:2016;
EN 61000-4-2 3d 2:2008; EN 61000-4-3 ed
3:2006/A1/A2; EN 61000-4-8 ed 2:2010; EN 61000-6-1 ed 3:2019;
EN61000-6-3 ed 2: 2007/A1.



Dispose of the device and batteries according to local regulations.

Connect

Situations in which the Smart Radiator Thermostat can be used:

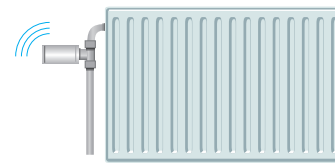

- ⊕ Mounted in horizontal position
- ⊕ Radiator Thermostat is not covered

1. Stand alone.

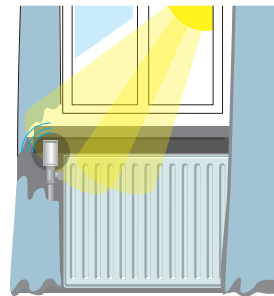

Add room thermostat in case:

- ⊕ Mounted vertical
- ⊕ Covered by objects
- ⊕ Hidden behind curtains
- ⊕ In direct sunlight

2. Dependent on room thermostat to compensate for reduced temperature measurement accuracy.

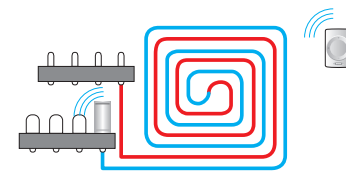

3. Wireless actuator function on a manifold.

To use the Smart Radiator Thermostat as an underfloor heating actuator, set the output to "Underfloor" in the commissioning tool.

For more detailed instructions follow the Technical Handbook at www.wavin.com/Sentio.

Adapter M28 / M30

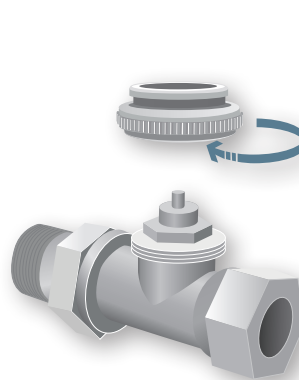

Adapter RA

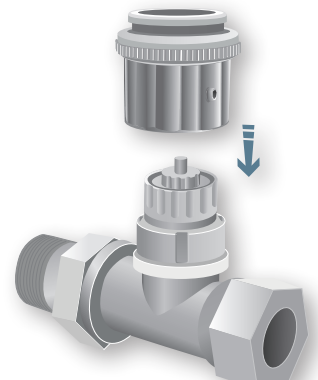

Check the valve compatibility list at www.wavin.com/Sentio.

With the correct adapter connected, click the Smart Radiator Thermostat on the radiator.

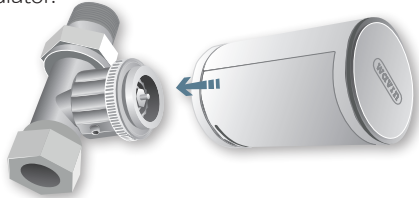

Set

To enroll the Smart Radiator Thermostat to the Central Control unit, select one of the 8 channel outputs on the unit and insert the batteries in the device. Or enroll via the Commissioning tool as instructed in the Technical Handbook.

When the Smart Radiator Thermostat is installed and enrolled the battery cover can be closed, this will start the automatic calibration sequence where the Smart Radiator thermostat adapts to the thermostatic valve.

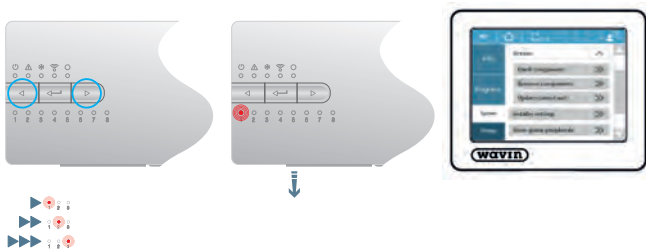

Opening battery cover

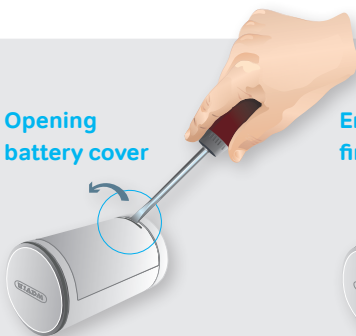

Enrolling first time

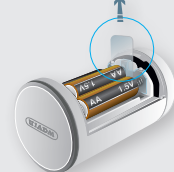

Dismounting:



Go!

How to connect to the APP

1

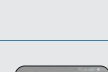

2

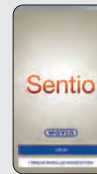

3



Registration Key (RK) is found on a sticker on the CCU, usually on the front.

4



Press the learn button on the CCU.



Warnings

Warning/error led meaning →
Check info in APP or Commissioning tool

Signals

Meaning

Yellow		Battery almost empty
Green		Enrolling successful*
Red		Lost signal
		Battery cover open
		Valve detection not yet finished

* Only available with Smart Radiator Thermostat firmware version 4.0 or higher



8.5. User Manual WiFi Bridge

WiFi Bridge (4065599) can be used to connect the Sentio Central Control Unit to a router via WiFi.

1. Power on device

- Plug the WiFi Bridge in a power socket close to the Sentio Central Control Unit.



2a. Set-up via WPS

- Press WPS button on router
- Press WPS button on WiFi bridge device

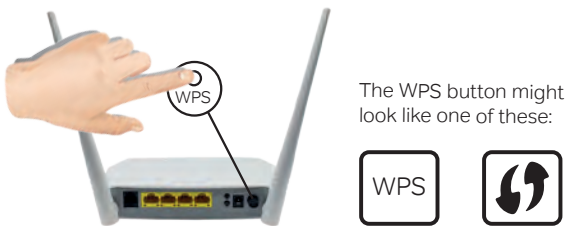

2b. Set-up via PC

- Connect PC or mobile to WiFi bridge (preferred ethernet cable to PC)
- Go to tplinkrepeater.net
- Make an account and/or login
- Follow the instructions on the site



3. Connect to the Sentio Control Unit

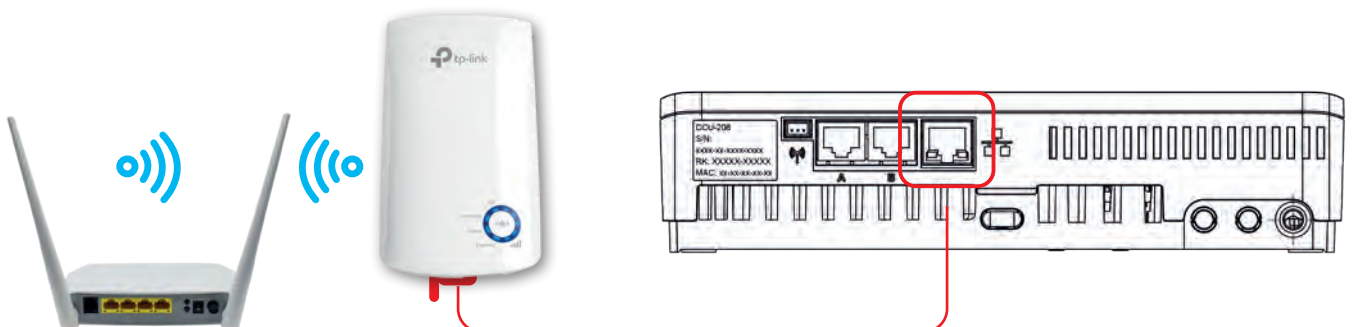

Wavin Sentio App

1. Download the app
2. Make an account
3. Scan the QR on the control unit
4. Press the learn button(H) once

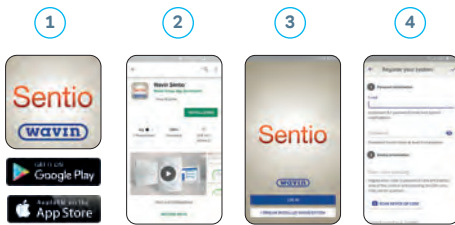

Sentio Control Unit LED Info

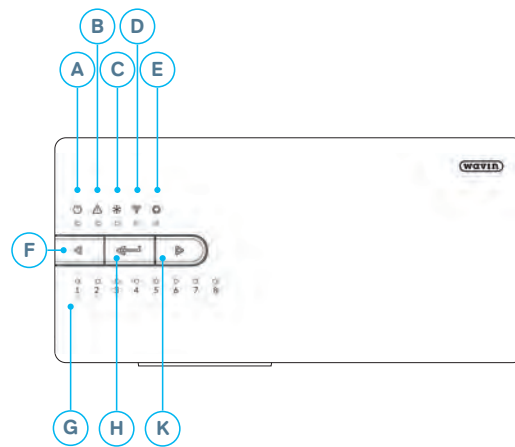

WiFi Bridge LED info

For more information on the WiFi Bridge see the instructions by the manufacturer by scanning the QR.



LED	Status	Indication (for range extender mode)
RE	On/Off	The extender is connected or not connected to your router's wireless network
	Blinking	WPS connection is in progress
Wireless	On/Off	The extender's wireless function is enabled or disabled
Power	On/Off	The extender is on or off
	Blinking	The system is starting up or firmware upgrade is in progress
(Signal strength)	On/Off	Indicates the WiFi connection between the extender and router. More lit LEDs indicates a better signal strength
Ethernet	On/Off	The Ethernet port is connected or not connected to a powered-on device

For more information on Sentio see the Technical Manual at www.Wavin.com/Sentio

Letter	LED/Button	Function	Light	Meaning
A		Status	Off Green On Red On	No power supply of the unit Power on – everything ok Bootloader is working
B		Warning	Yellow flash Yellow slow flash Yellow fast flash	Error, e.g. connection to peripheral lost Bootloader is working / preparing for update Update is running
C		Cooling	Blue On	Cooling is active
D		LAN status	Green On Green flash Green fast flash Blue On	Connection to LAN and cloud service Connected to LAN but no cloud service Learn mode active for registering unit to the app Auto update has found a new version and is ready to update
			Blue flash Blue fast flash	Auto update is ready to check for a new version Auto update is checking a new version
E		Global Peripheral channel	Green On Red flash	Global peripherals enrolled Enrolling mode (global peripherals can be connected)
F		Channel Selection	-	Select a channel by moving it to the left
G	1 - 16	Actuator channels	Red On Green On Blue On Purple On Cyan On	Heating Idle – no heating / no cooling Cooling Idle – Room without thermal actuator; e.g. room with Smart Radiator Thermostat Idle – Output used for special purposes E.g. External Actuator
			Red flash Red fast flash Green flash	Enrolling mode (peripherals can be connected) Output overloaded, heating demand Missing periphery
H		Enter		Confirm action, Learn mode to connect to the APP, Reset a channel (hold 10s), Factory Reset (hold 20s)
K		Channel Selection		Select a channel by moving it to the right

8.6. User Manual Sentio Outdoor Thermostat Sensor

How to install the Sentio Outdoor Temperature Sensor

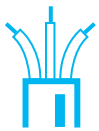
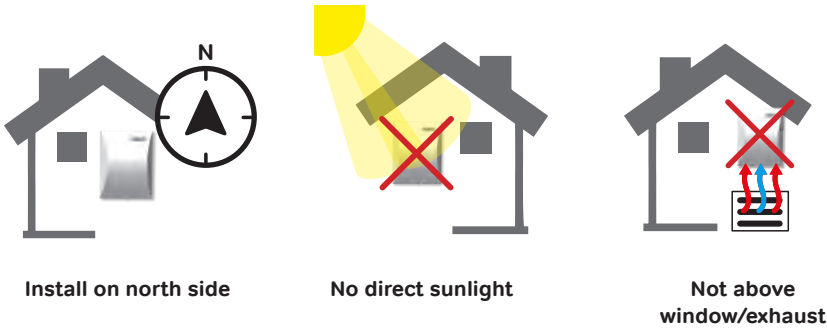

1. Wired Outdoor Temperature Sensor

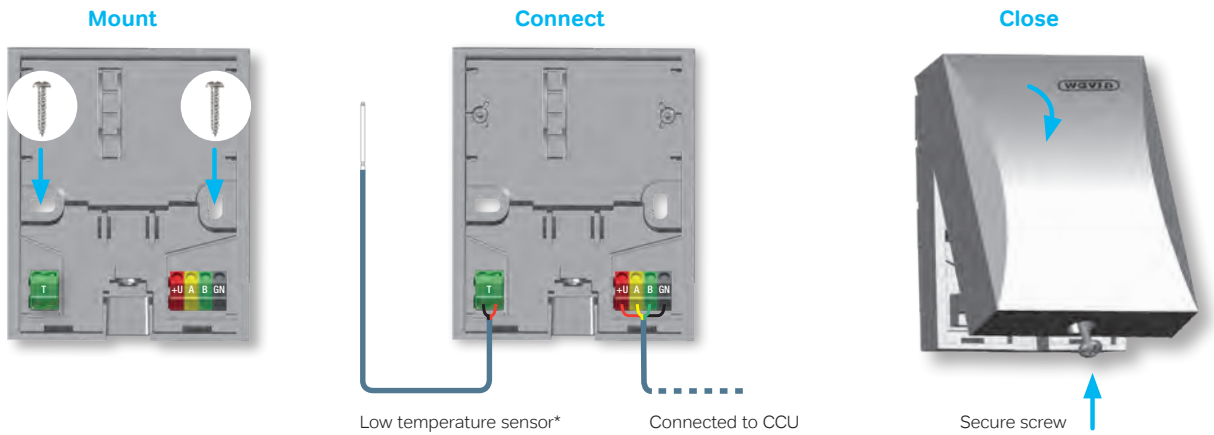

2. Wireless Outdoor Temperature Sensor

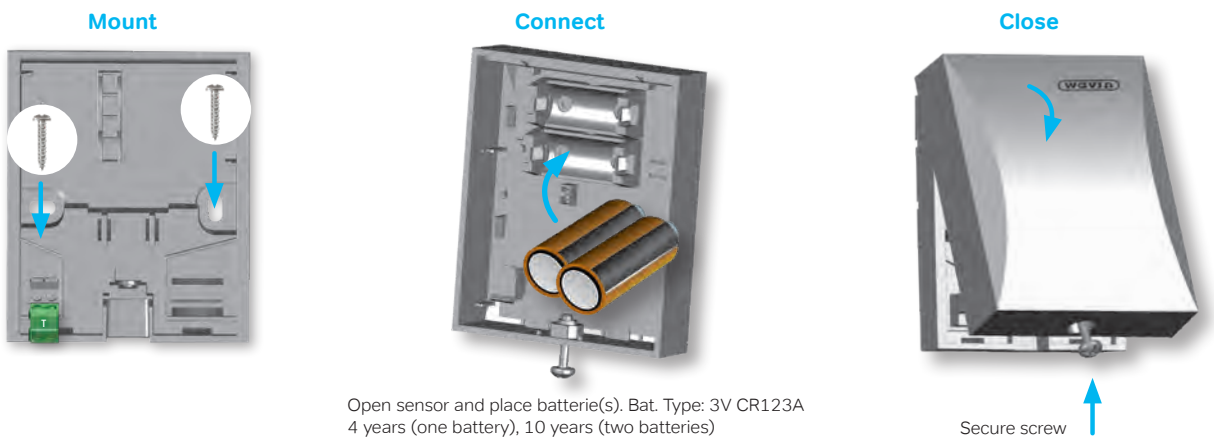

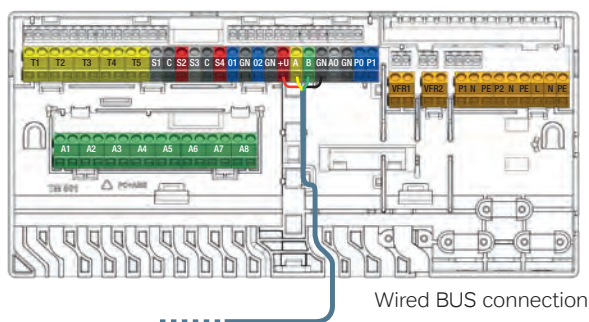

Enroll by navigating to the global channel.
Wired outdoor sensor is enrolled automatically.



Technical specifications Wired outdoor sensor

Power supply	10 V DC-30 V DC, typically 24 V DC
Device consumption	Max. 2mA in standby mode Avg. 1,2mA with PT1000
Control range temperature	25T60 (-25°C to +60°C)
Operational temperature	40T70 (-40°C to +70°C)
Dimensions	90 x 110 x 35mm
Weight	125g
Protection	IP53 (EN 60529)
Operation environment	humidity 0-99%, outdoor, no condensation
Complies with	EN 60730-1:2011, EN 55032:2012, EN 55024:2010 / A1:2015, EN 50581:2012, Directive 2014/30/EU, Directive 2011/65/EU

* Optional external sensor (type PT 1000) can be connected to enlarge the temperature control range from -50 °C to +200 °C (accuracy ±1°C).

Technical specifications Wireless outdoor sensor

Power supply	2,0-3,5V (3,0V Lithium battery type CR123A, 2 can be connected in parallel)
Battery service life	Typically 4 years (one battery) / 10 years (two batteries) Default one battery
Max. device consumption	50 mA, 20 µA Standby
Communication band	868,5 MHz
Communication range	Up to 200m (open area)
Control range temperature	25T60 (-25°C to +60°C)
Operational temperature	25T60 (-25°C to +60°C) (recommended for CR123A)
Dimensions	90 x 110 x 35mm
Weight	145g (without batteries)
Protection	IP53 (EN 60529)
Operation environment	humidity 0-99%, outdoor, no condensation
Complies with	EN 62368-1:2014 / Cor 1:2015/ A11:2017, ETSI EN 300 220-2 V3.1.1.2017, EN 60730-1:2011, EN 55032:2012, EN 55024:2010 / A1:2015, EN 50581:2012, Directive 2014/53/EU, Directive 2014/35/EU, Directive 2014/30/EU, Directive 2011/65/EU

* Optional external sensor (type PT 1000) can be connected to enlarge the temperature control range from -50 °C to +200 °C (accuracy ±1°C).













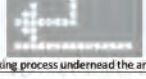

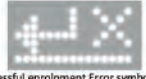









Thermostat Symbols

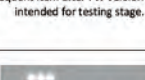
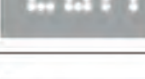
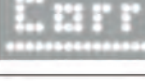
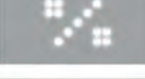

8.7. List of symbols (room thermostat)

Abreviation	Description	Heating	Cooling
[ECO]	Economic mode		
[CMF]	Comfort mode		
[XCMF]	Extra comfort mode		
[WAR]	Warning - general		
[WLB]	Warning - Low battery <10% Battery symbol		
[WFL]	Warning, floor heating blocked by floor security limit		
[WDP]	Warning -Dew point		
[WTL]	Too low temperature		
[WTH]	Too high temperature		
[TMP]	Temporary mode		
[TMP-CANC]	Temporary mode cancelation		
[HOL]	Holiday holiday symbol		
[STB]	Standby mode		

Abreviation	Description	Heating	Cooling
[TMP-CANC]	Holiday mode cancelation		
[LCK]	Locked		
[ULCK]	Unlocked		
[CRT]	Current room temperature		
[SRT]	Set room temperature		
[CFT]	Current floor temperature		
[SFT]	Set floor temperature		
[HUM]	Humidity		
[BAT]	Battery status A space inside the battery symbol is filled in accordance with current battery status.	 100% 50% 20%	
[RSS]	Radio Signal Strength (00 – 99) 00 = no signal 99 = extremely good signal		
[ELCW]	Lost of connection For Wireless device		
[ELCB]	Lost of connection For BUS powered device		

Abbreviation	Description	Heating	Cooling
[ERR]	General Error - Error symbol		
[OK]	Value saved or action was successful - OK symbol		
[REFUSE]	Access refused - No entry symbol Thermostat synchronizing data		
[ENR]	Enroll symbol - Enroll process is executing.		
[ENR-OK]	Successful enroll symbol		
	displayed after successful enroll		
[ENR-KO]	Unsuccessful enroll symbol displayed is CCU not respons		
[RNR]	Room Number number of room where thermostat is enrolled		
[R-SET]	Installer level 2 Common settings		
[REG]	Type of temperature regulation		
[AIR]	Air = Regulation by air temperature (floor sensor disabled)		
[A+F]	Air+Floor = Regulation by air temperature with floor limits		
[FLR]	Floor = Regulation by floor temperature		
[TLO]	Allowed user range for temperature settings Low limit		
[THI]	Allowed user range for temperature settings High limit		
[FLL]	Floor limit low		

Abbreviation	Description	Heating	Cooling
[FLH]	Floor limit high		
[L-SET]	Installer level 3 Thermostat settings		
[FWV]	Firmware version From original FW number are displayed two last numbers as FW version.		
[FWB]	Firmware beta version not for production used for FW testing purpose only		
	Displayed as consequent item after FW version [FWV] if firmware is intended for testing stage.		
[T-CD]	Correction of room (air) temperature sensor		
[FL-CO]	Correction of floor temperature sensor		
[H-CO]	Correction of room humidity sensor		
[BR-L]	Display brightness Low Selections: 1-2-3-4-5-6		
[BR-H]	Display brightness High Options: 1-2-3-4-5-6		
[TPS]	Touch pad sensitivity Options: Hi - Mid - Low		
			

Abreviation	Description	Heating	Cooling
			
[RST]	Reset to factory def. Options: YES – NO YES is underlined by progress bar. For successful confirmation the ">" button must be hold till progress bar is finished.		

8.8 List of compatible valves

Below you find a list of thermostatic valves there is tested and compatible with the Smart Radiator Thermostat

Manufacturer	Valve type	Thread	Adapter	Code
Oventrop	AF	M30x1,5	Grey	VA50
Oventrop	AV9	M30x1,5	Grey	VA50
Oventrop	EQ	M30x1,5	Grey	VA50
Danfoss	RA-N	-	White	VA72
Honeywell	V2000DBB20	M30x1,5	Grey	VA50
Comap	R809606	M28x1,5	Red	VA16
Comap	R859624B	M28x1,5	Red	VA16
Comap	R855424	M30x1,5	Grey	VA50
Comap	R869404B	M30x1,5	Grey	VA50
Herz	TS-98-V	M28x1,5	Red	VA16
Herz	TS-90	M28x1,5	Red	VA16
Heimeier	V-exact II	M30x1,5	Grey	VA50
Heimeier	Standard	M30x1,5	Grey	VA50
Heimeier	Verkort	M30x1,5	Grey	VA50
Heimeier	V-exakt	M30x1,5	Grey	VA50
Giacomini	R402H	M30x1,5	Grey	VA50
SIEMENS	VDN 215	M30x1,5	Grey	VA50

List of compatible radiator valves. An actual list can be found on the Sentio landing page www.wavin.com/sentio
If the actual brand/type of radiator valve is not found in the table, then please contact your local Wavin representative.

8.9 List of room status icons (Touch screen)

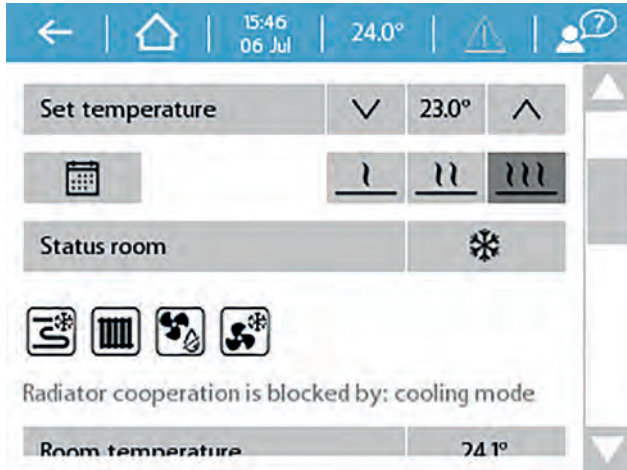

Example of room status icons for room. Icons are only visible if the associated device is connected to the room.

Mode or Device	Appliance	Idle	Active	Blocked
Heating	Status Room	-		
	Underfloor heating			
	Radiators			
	Thermal Integration (H/C coil)	-		
Cooling	Status Room	-		
	Underfloor cooling			
	Radiators		N/A	N/A
	Thermal Integration (H/C coil)	-		
Air handling	Dehumidifier			
Condensation risk	No appliance, calculated state of the air (dew point)	N/A		N/A

Wavin Sentio Modbus manual

8.10 . Wavin Sentio Modbus manual

Contents

Requirements	1
Bus parameters	1
Modbus connection on Sentio control unit	2
RJ-45 pin layout in Wavin Sentio control unit	2
Activating and setup of the Modbus	2
Modbus values	2
List of values	2
Versioning	2
Modbus registers	3
Modbus commands	3
Error handling and return codes	3
Modbus error codes	3
Device booting	4
Invalid value	4
Data validation	4
Data types	4
Reading and writing text values (datatype val_utf8)	4
Appendix	5

Requirements

This manual covers the Modbus specification for Sentio control units with firmware version TM60006.0 or higher.
For the Modbus TCP/IP function the control unit needs to be firmware version TM60014 or higher.

Bus parameters

Parameter	Values	
Transmission mode	RTU	TCP
Supported baud rates	9600,19200(default),38400, 57600 bps	-
Default address	1(default) - 247	IP ADDRESS:502 (unit ID 255 (0xFF) if needed)
Data bits	8	-
Parity	None, odd, even	-
Stop bit	0, 1, 2	-
Possible modes	Disabled (Default), Read only, Read/write, write with password, Master	Disabled (Default), Read only, Read/write, write with password
Physical interface	RS-485 on port A	RJ-45 on LAN port
Reply time limit	Timeout = 500 mS	Timeout = 500 mS
Max reading volume at once:	Max 32 pcs register or 256 bits	Max 32 pcs register or 256 bits

Modbus RTU connection on Sention control unit

The Modbus RTU shall be connected to the most left RJ-45 connector at the bottom of the Sention Control unit. The RJ-45 connector is marked with an "A". This is the only port able to do Modbus RTU.

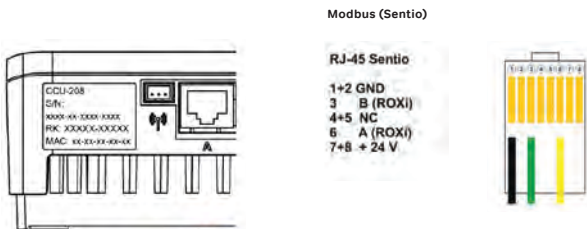

RJ-45 pin layout in Wavin Sention control unit

Pin no.	
1	GND
2	GND
3	B
4	Not connected
5	Not connected
6	A
7	+ 24 V
8	+ 24 V

Activating and setup of the Modbus RTU

By default is the Modbus RTU connection deactivated. It is only possible to activate the Modbus RTU RJ-45 port A by using a Sention Display. To activate the Modbus, go to [System | Installer settings | Modbus configuration | Modbus RTU](#) and select the desired mode. After selection of Modbus mode, the Sention control unit is restarted.

Remark: After activating the Modbus mode it not possible to use the RJ-45 A connector for the Sention display.

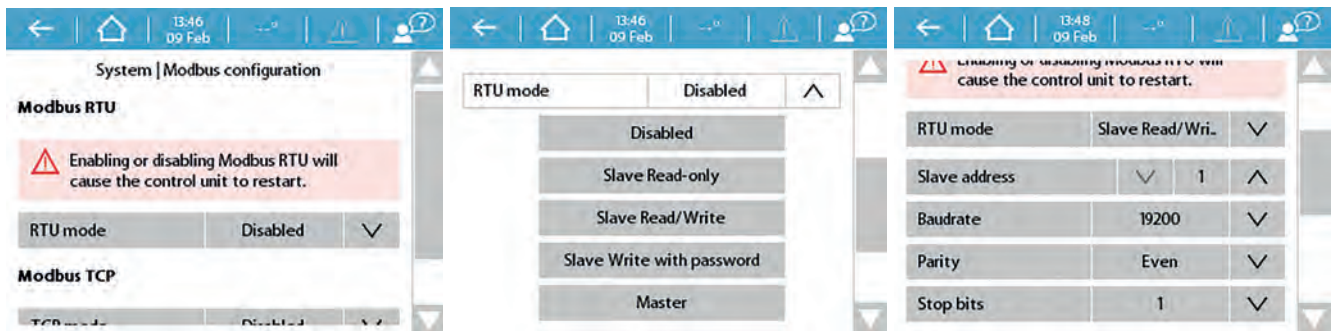

Connection to Sentio Modbus TCP/IP

For Modbus TCP/IP an ethernet connection will be made using the RJ-45 LAN port .

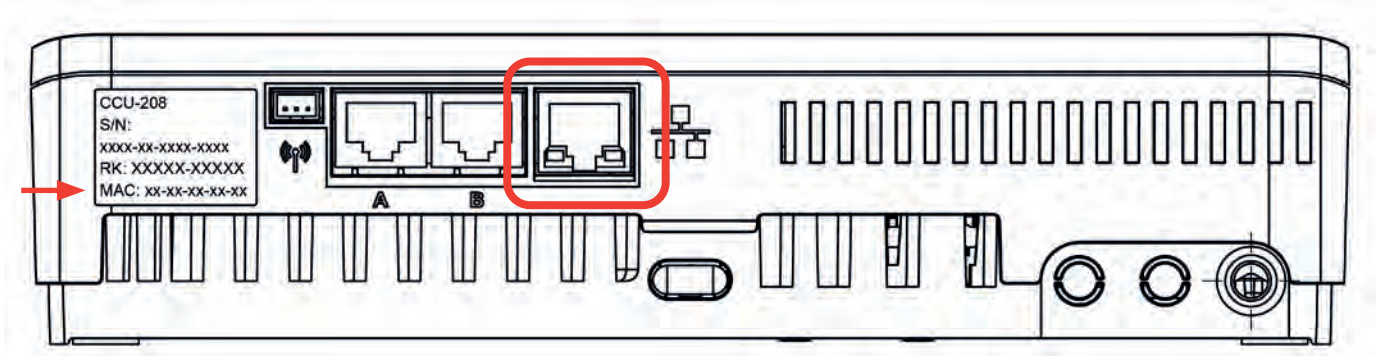

Activation and setup of Modbus TCP/IP

Activate the Modbus TCP/IP via the Sentio display by going to [System | Installer Settings | Modbus settings - Modbus TCP](#). After selecting the TCP mode, the function is activated.

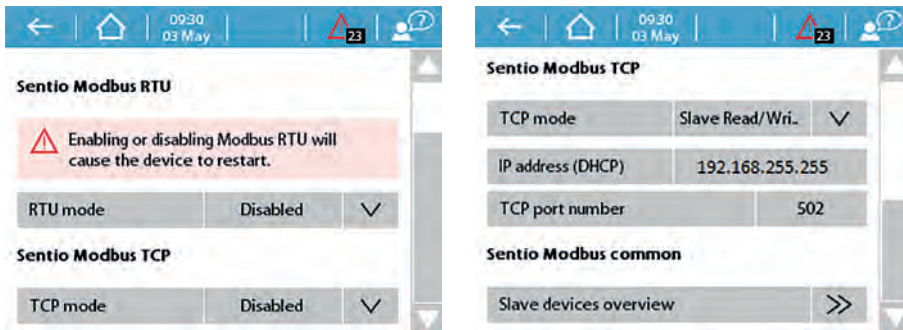

The Sentio device uses a dynamic IP address obtained via an DHCP request. If the IP address requires to be static for the network this can be achieved by configuring the applicable switch or router to serve a static IP address based on MAC address or hostname. The MAC address can be obtained via the sticker on the unit, the hostname used by the Sentio system is:

DHCP: Wavin Sentio CCU#[last four S/N digits]

When using Modbus RTU master to connect to an external device (e.g. Ventiza mechanical ventilation) it is still possible to use the Modbus TCP/IP slave function to connect to a building management system.

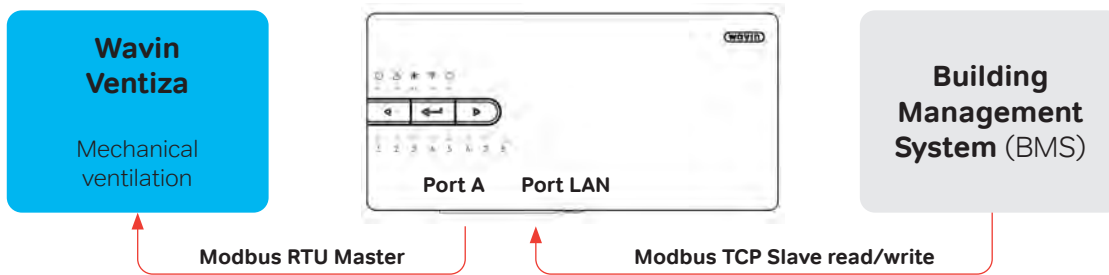

Modbus values

List of values

The complete list of values is described appendix 1 in this manual.

Versioning

The list of Modbus values is not finite. As new features are implemented, new values are added. If you want to know exactly which values are offered by your system:

- a. Read following Modbus registers or check the 'system information' in the touch screen.

Modbus adress	Value name	Description
00001	Adress space major version	Incremented on incompatible change E.g. when changing format or removing values
00002	Adress space minor version	Incremented on compatible change E.g. when adding new values

- b. Find the FW-version at the right side of the 2. row in Appendix 1.
- c. The values marked as Yes in this column are supported by your system. If a value is needed that is not supported by the current version, please update the central control unit or contact Wavin support.

Modbus registers

The Modbus offers several types of registers. Following types are supported by Sentio.

Area name	Access width	Access type	Usage
Discrete inputs	1-bit	Read only	Read system alarms and warnings
Input registers	16-bit registers	Read only	Read state values
Holding registers	16-bit registers	Read / Write	Read/write configuration

Modbus commands

The registers described in the previous chapter can be accessed using following commands.

See Modbus specification for packet format - http://modbus.org/docs/Modbus_Application_Protocol_V1_1b3.pdf

Code	Command	Area
0x02	Read discrete inputs	Discrete inputs
0x03	Read holding registers	Holding registers
0x04	Read input registers	Input registers
0x06	Write single register	Holding register
0x10	Write multiple registers	Holding registers

Error handling and return codes

Modbus error codes

Exception code	Command	Area
01	Illegal function	Returned when unknown command is used. See Modbus Commands for list of supported commands.
02	Illegal data address	Returned when reading or writing to register, which does not exist. NOTE: This is also the case when multiple registers are accessed in a function and one or more registers don't exist and some registers might exist.
03	Illegal data value	Returned when writing register by a value, which is not supported. See appendix 1 for list of supported values.
04	Slave device failure	Returned when reading of writing register, which contains values from a peripheral, which is disconnected - e.g. the Calefa controller.
06	Server device busy	Returned during device start-up, or when data integrity cannot be guaranteed.

Device booting

Device returns exception code SERVER DEVICE BUSY (06) during start-up, because data integrity cannot be guaranteed during start-up. Please wait for the system to finish its start-up.

Invalid value

If a measured value is not initialized -e.g. due to failure or long response time from wireless peripherals -then INVALID_VALUE is returned as a response to read command.

Data validation

When a configuration data is set, then it is validated and can be modified by system to meet the system requirements or it can be rejected.

- ⦿ If value is lower than minimum, then it is set to minimum
- ⦿ If value is higher than maximum, then it is set to maximum
- ⦿ If value is not aligned to step, it is aligned (e.g. temperature 15.2 is aligned to 15.0)
- ⦿ If a string value (val_utf8) is longer than the device can store, the string is shortened

Data types

All Modbus registers consist of 16 bits of data. The meaning of this data can be different and multiple registers can be combined to hold more data. Following data types are supported:

Type	Length	Range	Invalid value
val_enum	1B	0..255	0xFF
val_u	1B	0..255	0xFF
val_u2	2B	0..65535	0xFFFF
val_u4	4B	0..4294967295	0xFFFFFFFF
val_utf8	2b LEN + UTF8	Utf8. max 256B	LEN= 0xFFFF, no data
val_d2_fp100	2B	Fixed-point (-327,68..327,67)	0x7FFF

Reading and writing text values (datatype val_utf8)

val_utf8 is composed by multiple 16 bits holding registers, but the data itself is an array of bytes. When for instance the string "Hello" is stored in the array the first byte is placed first in the packet etc. This results in a read response of:

Command

Command code	Byte count	Reg X Hi	Reg X Lo	Reg X+1 Hi	Reg X+1 Lo	Reg X+2 Hi	Reg X+2 Lo	Reg X+3 Hi	Reg X+3 Lo
0x03	0x08	"H"	"e"	"l"	"l"	"o"	"0x00"	"0x00"	"0x00"

It is also possible to store UTF-8 strings – e.g. "Blå Værelse". In this case, the national characters are encoded into multiple bytes. We see that 13 bytes will be needed to save the entire text.

Character	Value
B	0x42
l	0x6c
å	0xc3
	0xa5
v	0x56
æ	0xc3
	0xa6
r	0x72
e	0x65
l	0x6c
s	0x73
e	0x65

Appendix

Object	Parameter	R/W	Modbus Table	Modbus Address	Data type	Description	Address space version			
							3.0 FW 8	3.1 FW 10	3.2 FW 12	3.3 FW 14
LOCATION										
Location				000xx						
	Aggregated warning	R	Discrete Inputs	00001		A problem is pending in whole system (Location)	YES	YES	YES	YES
	Aggregated error	R	Discrete Inputs	00002		A critical problem is pending in whole system (Location)	YES	YES	YES	YES
	Address space major version	R	Input Register	00001	val_u1	= 3 (Incremented on incompatible change)	CHANGED		YES	YES
	Address space minor version	R	Input Register	00002	val_u1	= 1 (Incremented on compatible change)	YES	CHANGED	YES	YES
	Dev type	R	Input Register	00010	val_u1	1 - CCU-208 2 - DHW-201 (Calefa)	YES	YES	YES	YES
	Dev hw version	R	Input Register	00011	val_u1		YES	YES	YES	YES
	Dev sw version	R	Input Register	00012	val_u1		YES	YES	YES	YES
	Dev sw version minor	R	Input Register	00013	val_u1		YES	YES	YES	YES
	Dev serial number prefix	R	Input Register	00014	val_u2	= 1530	YES	YES	YES	YES
	Dev serial number	R	Input Register	00015-00016	val_u4		YES	YES	YES	YES
	Heating/Cooling mode	R	Input Register	00020	val_u1	0 - HEATING 1 - COOLING	-	YES	YES	YES
	Address space major version	R/W	Holding register	00001	val_u1	= 3 (Incremented on incompatible change)	CHANGED	YES	YES	YES
	Address space minor version	R/W	Holding register	00002	val_u1	= 1 (Incremented on compatible change)	YES	CHANGED	YES	YES
	Modbus slave address	R/W	Holding register	00003	val_u1	Allowed values: 1 to 247 Default: 1	YES	YES	YES	YES
	Modbus baudrate	R/W	Holding register	00004	val_u2	Allowed values: 9600, 19200, 38400, 57600 Default: 19200	YES	YES	YES	YES
	Modbus mode	R/W	Holding register	00005	val_u1	0 DISABLED 1 READ_ONLY 2 READ_WRITE 3 WRITE_WITH_PASSWORD Default: 0	EXTENDED	YES	YES	YES
	Modbus password	W	Holding register	00006	val_u2	When Modbus mode = WRITE_WITH_PASSWORD, the write commands are disabled until this register is written by a valid password. Once the password is written, the write commands are accepted for next 11 minutes. Then the password has to be set again. Two steps are required for password change: 1. Write the old password 2. Write the new password before 11 minutes elapses. Default password: 1234, Write only, range for passwd is 1 - 65535	YES	YES	YES	YES
	Modbus parity	R/W	Holding register	00007	val_u1	0 - NONE 1 - ODD 2 - EVEN	-	YES	YES	YES
	Modbus stop bits	R/W	Holding register	00008	val_u1	0 - 1 STOP BIT 1 - 2 STOP BITS	-	YES	YES	YES
	Location name	R/W	Holding register	00010-00025	val_ut8	Placeholder for 32 bytes of location description. See "working with strings" chapter for more info.	YES	YES	YES	YES
	Standby	R/W	Holding register	00026	val_u1	0 OFF 1 ON	YES	YES	YES	YES
	Vacation	R/W	Holding register	00027	val_u1	0 OFF 1 ON	YES	YES	YES	YES
	Datetime	R/W	Holding register	00028-00029	val_u4	Current time - unit timestamp format - localtime including DST (if enabled)	YES	YES	YES	YES
	Daylight saving time allowed	R/W	Holding register	00030	val_u1	0 Disabled 1 Enabled	YES	YES	YES	YES
	Cooling minimum outdoor temperature	R/W	Holding register	00031	val_d2_fp100	Cooling is blocked, when outdoor temperature is lower than this value.	YES	YES	YES	YES
	Heating maximum outdoor temperature	R/W	Holding register	00032	val_d2_fp100	Heating is blocked, when outdoor temperature is higher than this value.	YES	YES	YES	YES
	Update mode	R/W	Holding register	00033	val_u1	0 Dont allow from mobile app 1 Enabled 2 Disabled entirely	-	YES	YES	YES
	Heating/Cooling mode BMS override	R/W	Holding register	00034	val_u1	Note: Only available in hardware profiles, which support manual H/C change-over. In other profiles override is set to DISABLED. 0 - DISABLED 1 - HEATING MODE 2 - COOLING MODE 3 - H/C MODE SET BY EXTERNAL SWITCH (only when HW input is available)	-	-	YES	YES
	Timezone number	R/W	Holding register	00035	val_u2	For list of supported timezones see tab "Timezone list"	-	-	YES	YES
ROOMS (INDOOR ZONES)										
Room 1										
ROOM TYPE				001xx		Note: Dummy room is special type of room, where no thermostat or sensor is installed. Dummy room does not support cooling mode. To find out room type, check input register 127.				
NORMAL, DUMMY	Aggregated warning	R	Discrete Inputs	00101		A problem is pending in Room	YES	YES	YES	YES
NORMAL, DUMMY	Aggregated error	R	Discrete Inputs	00102		A critical problem is pending in Room	YES	YES	YES	YES
NORMAL	Warning - low battery	R	Discrete Inputs	00103		There are one or more peripherals in the room with low battery.	YES	YES	YES	YES
NORMAL	Error - peripheral lost	R	Discrete Inputs	00104		There are one or more peripherals in the room which are not responding.	YES	YES	YES	YES
NORMAL, DUMMY	Desired temp	R	Input Register	00101	val_d2_fp100	Shows the desired temperature in the room.	YES	YES	YES	YES
NORMAL, DUMMY	General Heating/Cooling state (radiator underfloor integration)	R	Input Register	00102	val_u1	1 IDLE 2 HEATING 3 COOLING 4 BLOCKED_HEATING 5 BLOCKED_COOLING	EXTENDED	YES	YES	YES
NORMAL, DUMMY	General Heating/Cooling blocking source (radiator underfloor integration)	R	Input Register	00103	val_u1	Please check top of the document - GENERAL BLOCKING SOURCES	EXTENDED	YES	YES	YES
NORMAL	Air temperature	R	Input Register	00104	val_d2_fp100	Current air temperature measured in the room.	YES	YES	YES	YES
NORMAL	Floor temperature	R	Input Register	00105	val_d2_fp100	Current floor temperature measured in the room.	YES	YES	YES	YES
NORMAL	Relative humidity	R	Input Register	00106	val_d2_fp100	Current humidity measured in the room.	YES	YES	YES	YES
NORMAL	Calculated dew point	R	Input Register	00107	val_d2_fp100	Current calculated dewpoint	YES	YES	YES	YES
NORMAL	Associated to Radiators	R	Input Register	00111	val_u1	0 .. NONE 73 .. ITC1 (Address of modbus object) 74 .. ITC2 (Address of modbus object) 77 .. HCC1 (Address of modbus object) 78 .. HCC2 (Address of modbus object) 79 .. HCC3 (Address of modbus object) 81 .. H/C Source (Address of modbus object)	YES	CHANGED	YES	YES
NORMAL	Associated to UFHC	R	Input Register	00112	val_u1	0 .. NONE 73 .. ITC1 (Address of modbus object) 74 .. ITC2 (Address of modbus object) 77 .. HCC1 (Address of modbus object) 78 .. HCC2 (Address of modbus object) 79 .. HCC3 (Address of modbus object)	YES	CHANGED	YES	YES
NORMAL	Associated to Drying (humidity control)	R	Input Register	00114	val_u1	0 .. NONE 650 .. AHU 1 (Address of modbus object) 651 .. AHU 2 (Address of modbus object) 652 .. AHU 3 (Address of modbus object) 653 .. AHU 4 (Address of modbus object)	-	YES	YES	YES
NORMAL	Associated to Thermal integration (thermal, integ control)	R	Input Register	00115	val_u1	0 .. NONE 650 .. AHU 1 (Address of modbus object) 651 .. AHU 2 (Address of modbus object) 652 .. AHU 3 (Address of modbus object) 653 .. AHU 4 (Address of modbus object)	-	YES	YES	YES
NORMAL	Associated to Ventilation (air quality control)	R	Input Register	00116	val_u1	0 .. NONE 610 .. Ventilation 1 (Address of modbus object) 611 .. Ventilation 2 (Address of modbus object)	-	-	-	YES

NORMAL	Radiators state (air temperature)	R	Input Register	00117	val_u1	0 NONE (not used in this room or load was not detected on at least one output) 1 IDLE 2 HEATING 3 COOLING 4 BLOCKED_HEATING 5 BLOCKED_COOLING	-	YES	YES	YES
NORMAL	Underfloor Heating/Cooling state (floor temperature)	R	Input Register	00118	val_u1	0 NONE (not used in this room or load was not detected on at least one output) 1 IDLE 2 HEATING 3 COOLING 4 BLOCKED_HEATING 5 BLOCKED_COOLING	-	YES	YES	YES
NORMAL	Drying state (relative humidity)	R	Input Register	00119	val_u1	0 NONE (not used in this room) 1 IDLE 2 DRYING 3 BLOCKED_DRYING	-	YES	YES	YES
NORMAL	Thermal integration state (air temperature)	R	Input Register	00120	val_u1	0 NONE (not used in this room) 1 IDLE 2 HEATING 3 COOLING 4 BLOCKED_HEATING 5 BLOCKED_COOLING	-	YES	YES	YES
NORMAL	Ventilation state	R	Input Register	00121	val_u1	0 NONE (not used in this room) 1 STOPPED 2 UNOCCUPIED 3 ECONOMY 4 COMFORT 5 BOOST 6 BLOCKED	-	-	-	YES
NORMAL	Blocking source - Radiators	R	Input Register	00122	val_u1	Same as Heating/Cooling blocking source	-	YES	YES	YES
NORMAL	Blocking source - Underfloor Heating/Cooling	R	Input Register	00123	val_u1	Same as Heating/Cooling blocking source	-	YES	YES	YES
NORMAL	Blocking source - Drying	R	Input Register	00124	val_u1	Same as Heating/Cooling blocking source	-	YES	YES	YES
NORMAL	Blocking source - Integration	R	Input Register	00125	val_u1	Same as Heating/Cooling blocking source	-	YES	YES	YES
NORMAL	Blocking source - Ventilation	R	Input Register	00126	val_u1	Same as Heating/Cooling blocking source	-	-	-	YES
NORMAL, DUMMY	Room type	R	Input Register	00127	val_u1	0 - NORMAL (DEFAULT) 1 - DUMMY (no thermostat or sensor installed)	-	-	-	YES
DUMMY	Associated Heating Source	R	Input Register	00128	val_u1	0 .. NONE 73 .. ITC1 (Address of modbus object) 74 .. ITC2 (Address of modbus object) 77 .. HCC1 (Address of modbus object) 78 .. HCC2 (Address of modbus object) 79 .. HCC3 (Address of modbus object) 81 .. H/C Source (Address of modbus object)	-	-	YES	YES
NORMAL, DUMMY	Room name	R/W	Holding register	00101-00116	val_utf8	String description (32 Bytes, UTF8, NULL terminated)	YES	YES	YES	YES
NORMAL, DUMMY	Room mode	R/W	Holding register	00117	val_u1	0 SCHEDULE 1 MANUAL In SCHEDULE mode, the "Room temperature setpoint" is not used and the room temperature is controlled by scheduler.	YES	YES	YES	YES
NORMAL, DUMMY	Room mode override	R/W	Holding register	00118	val_u1	0 NONE 1 TEMPORARY 2 VACATION_AWAY 3 ADJUST In override mode (> NONE), the "Room temperature setpoint" is not used. The requested temperature is corrected by user via room thermostat or mobile application. You can disable the override mode by setting this value to 0 (NONE)	YES	YES	YES	YES
NORMAL	Room temperature setpoint	R/W	Holding register	00119	val_d2_fp100	Temperature requested by user. This value is not used when - Room mode = SCHEDULE (Scheduler temperature is used) - Location.Vacation = ON (Vacation temperature is used) - Location.Standby = ON (Standby temperature is used) - Temporary mode is activated (User defined temperature is used)	YES	YES	YES	YES
NORMAL	User Interface access level (thermostat lock)	R/W	Holding Register	00120	val_u1	8 LOCKED (Read Only) 16 HOTEL 32 UNLOCKED	YES	YES	YES	YES
NORMAL, DUMMY	Standby temperature	R/W	Holding Register	00121	val_d2_fp100	Room temperature setpoint used when the system is in Standby mode	YES	YES	YES	YES
NORMAL, DUMMY	Vacation temperature	R/W	Holding Register	00122	val_d2_fp100	Room temperature setpoint used when the system is in Vacation mode	YES	YES	YES	YES
NORMAL, DUMMY	Exclude from vacation	R/W	Holding Register	00123	val_u1	Do not allow the Vacation mode in this room	YES	YES	YES	YES
NORMAL	Adaptive mode	R/W	Holding Register	00124	val_u1	Allow adaptive mode	YES	YES	YES	YES
NORMAL	Thermal integration heating offset	R/W	Holding Register	00125	val_d2_fp100	Thermal integration heating offset	-	YES	YES	YES
NORMAL	Thermal integration hysteresis	R/W	Holding Register	00126	val_d2_fp100	Thermal integration hysteresis	-	YES	YES	YES
NORMAL	Humidity threshold heating	R/W	Holding Register	00127	val_d2_fp100	Humidity threshold heating	-	YES	YES	YES
NORMAL	Humidity threshold cooling	R/W	Holding Register	00128	val_d2_fp100	Humidity threshold cooling	-	YES	YES	YES
NORMAL	Humidity hysteresis	R/W	Holding Register	00129	val_d2_fp100	Humidity hysteresis	-	YES	YES	YES
NORMAL	Drying - cooling water offset	R/W	Holding Register	00130	val_d2_fp100	Drying - cooling water offset	-	YES	YES	YES
NORMAL	Drying - cooling water offset hysteresis	R/W	Holding Register	00131	val_d2_fp100	Drying - cooling water offset hysteresis	-	YES	YES	YES
NORMAL	Dew point cooling threshold	R/W	Holding Register	00132	val_d2_fp100	Dew point threshold temp when cooling	-	YES	YES	YES
NORMAL	Dew point cooling threshold hysteresis	R/W	Holding Register	00133	val_d2_fp100	Dew point threshold temp hysteresis when cooling	-	YES	YES	YES
NORMAL	Humidity high alarm limit	R/W	Holding Register	00134	val_d2_fp100	Humidity high alarm limit	-	YES	YES	YES
DUMMY	Room temperature preset	R/W	Holding register	00135	val_u1	0 - ECO 1 - COMFORT 2 - EXTRA COMFORT Temperature preset requested by user. This value is not used when - Room mode = SCHEDULE (Scheduler temperature is used) - Location.Vacation = ON (Vacation temperature is used) - Location.Standby = ON (Standby temperature is used) - Temporary mode is activated (User defined temperature is used)	-	-	YES	YES
Room 2	Same as Room 1			002xx						
Room 3	Same as Room 1			003xx						
---				---						
Room 24	Same as Room 1			024xx						
OUTDOOR ZONES										
Outdoor 1										
	Aggregated warning	R	Discrete Inputs	03301		A problem is pending in Outdoor zone	YES	YES	YES	YES
	Aggregated error	R	Discrete Inputs	03302		A critical problem is pending in Outdoor zone	YES	YES	YES	YES
	Warning - low battery	R	Discrete Inputs	03303		There are one or more peripherals in the Outdoor zone with low battery.	YES	YES	YES	YES
	Error - peripheral lost	R	Discrete Inputs	03304		There are one or more peripherals in the Outdoor zone which are not responding.	YES	YES	YES	YES
	Air Temp	R	Input Register	03301	val_d2_fp100	Used for Frost protection, Cooling blocking, H/C mode switching	YES	YES	YES	YES
	Air Temp Filtered	R	Input Register	03302	val_d2_fp100	Used in Heat curve calculations, H/C blocking (to be changed)	YES	YES	YES	YES
	Air Temp Geometrical	R	Input Register	03303	val_d2_fp100	Not yet used in the code (pending issue)	YES	YES	YES	YES
	Name	R/W	Holding Register	03301-03316	val_utf8	String description (32 Bytes, UTF8, NULL terminated)	YES	YES	YES	YES
	Air Temp BMS Override	R/W	Holding Register	3317	val_d2_fp100	Enables to put artificial external temperature used for ITC1 INVALID ... it will not be used	YES	YES	YES	YES

DHW CONTROLLERS									
DHW Calefa									
Aggregated warning	R	Discrete Inputs	065xx						
Aggregated error	R	Discrete Inputs	06501		A problem is pending in DHW	YES	YES	YES	YES
Warning - Retentive Low Energy	R	Discrete Inputs	06503		A critical problem is pending in DHW	YES	YES	YES	YES
Error - DHW temp high	R	Discrete Inputs	06504			YES	YES	YES	YES
Error - Motor failure	R	Discrete Inputs	06505			YES	YES	YES	YES
Error - DHI sensor failure (source inlet)	R	Discrete Inputs	06506			YES	YES	YES	YES
Error - DHO sensor failure (source return)	R	Discrete Inputs	06507			YES	YES	YES	YES
Error - DHW sensor failure	R	Discrete Inputs	06508			YES	YES	YES	YES
Error - DCW sensor failure	R	Discrete Inputs	06509			YES	YES	YES	YES
Warning - Pressure high	R	Discrete Inputs	06510			YES	YES	YES	YES
Warning - Pressure low	R	Discrete Inputs	06511			YES	YES	YES	YES
Error - Pressure critical low	R	Discrete Inputs	06512			YES	YES	YES	YES
Desired DHW temp	R	Input Register	06501	val_d2_fp100	Shows the desired temperature of the domestic hot water.	YES	YES	YES	YES
State	R	Input Register	06502	val_u1	1 IDLE 2 HEATING (hot water is consumed by user) 3 BYPASS (keeping heat exchanger hot for circulation) 4 BLOCKED_HEATING 5 BLOCKED_BYPASS Shows, whether the system wants to heat or to have bypass activated.	CHANGED	YES	YES	YES
Blocking source	R	Input Register	06503	val_u1	Same as Heating/Cooling blocking source	YES	YES	YES	YES
Circulation state	R	Input Register	06504	val_u1	0 NONE (disabled) 1 IDLE 2 ON	CHANGED	YES	YES	YES
Measured DHW temp	R	Input Register	06505	val_d2_fp100	Current temperature of the domestic hot water flowing from DHW	YES	YES	YES	YES
Source - Inlet temp	R	Input Register	06506	val_d2_fp100	Current temperature of the water incoming from the heat source.	YES	YES	YES	YES
Source - Return temp	R	Input Register	06507	val_d2_fp100	Current temperature of the water returning to the heat source.	YES	YES	YES	YES
Pressure	R	Input Register	06508	val_d2_fp100	Current pressure of the secondary system	YES	YES	YES	YES
Name	R/W	Holding Register	06501 - 06516	val_utf8	String description (32 Bytes, UTF8, NULL terminated)	YES	YES	YES	YES
Mode	R/W	Holding Register	06517	val_u1	0 SCHEDULE 1 SCHEDULE_ADAPTIVE 2 ECO 3 COMFORT Eco = circulation and hot bypass are disabled Comfort = circulation and hot bypass are enabled	YES	YES	YES	YES
User interface access level (calefa display lock)	R/W	Holding Register	06518	val_u1	<40 USER (user menu) >=40 INSTALLER (inst. menu)	YES	YES	YES	YES
Block request	R/W	Holding Register	06519	val_u1	0 NONE 1 BLOCK_REQUEST When BLOCK_REQUEST is set, then the system blocks heating and bypass to eliminate consumption from heat supplier.	YES	YES	YES	YES
Power consumption limit	R/W	Holding Register	06520	val_u2		YES	YES	YES	YES
DHW temp set	R/W	Holding Register	06521	val_d2_fp100	Requested temperature of domestic hot water.	YES	YES	YES	YES
DHW bypass temp	R/W	Holding Register	06522	val_d2_fp100		YES	YES	YES	YES
Circulation - Pump present	R/W	Holding Register	06523	val_u1	0 DISABLED 1 ENABLED (scheduler)	YES	YES	YES	YES
Circulation - Inlet temp	R/W	Holding Register	06524	val_d2_fp100	When circulation is enabled and there is NO dhw consumption, then the DHW temperature is regulated to this value.	YES	YES	YES	YES
Exclude from vacation	R/W	Holding Register	06525	val_u1	Do not allow the Vacation mode	YES	YES	YES	YES
Exclude from standby	R/W	Holding Register	06526	val_u1	Do not allow the Standby mode	YES	YES	YES	YES
ITC CONTROLLERS									
ITC1									
Aggregated warning	R	Discrete Inputs	073xx						
Aggregated error	R	Discrete Inputs	07301		A problem is pending in ITC	YES	YES	YES	YES
Error - Inlet Sensor Failure	R	Discrete Inputs	07302		A critical problem is pending in ITC	YES	YES	YES	YES
Error - Servo Failure	R	Discrete Inputs	07303		Missing or broken sensor	YES	YES	YES	YES
Error - Return Sensor Failure	R	Discrete Inputs	07304		Missing or broken sensor	YES	YES	YES	YES
Error - Outdoor Sensor Failure	R	Discrete Inputs	07305		Missing or broken sensor	YES	YES	YES	YES
Error - High temp cut-off activated	R	Discrete Inputs	07306		Safety mechanism "high temp cut-off" is activated	YES	YES	YES	YES
Error - Frost protection activated	R	Discrete Inputs	07307		Safety mechanism "frost protection" is activated	YES	YES	YES	YES
State	R	Input Register	07301	val_d1	1 IDLE 2 HEATING 3 COOLING 4 BLOCKED_HEATING 5 BLOCKED_COOLING	YES	YES	YES	YES
Blocking source	R	Input Register	07302	val_u1	Same as Heating/Cooling blocking source	YES	YES	YES	YES
Pump - Demand	R	Input Register	07303	val_u1	1 IDLE 2 ON	YES	YES	YES	YES
Pump - State	R	Input Register	07304	val_u1	1 IDLE 2 ON	YES	YES	YES	YES
Measured inlet temperature	R	Input Register	07305	val_d2_fp100	Measured temperature of the inlet heating/cooling water.	YES	YES	YES	YES
Desired inlet temperature	R	Input Register	07306	val_d2_fp100	Desired temperature of the inlet heating/cooling water. The value which the ITC regulator wants to meet.	YES	YES	YES	YES
Measured return temperature	R	Input Register	07307	val_d2_fp100	Measured return temperature	YES	YES	YES	YES
Main supplier temperature	R	Input Register	07308	val_d2_fp100	Main supplier temperature	-	YES	YES	YES
Name	R/W	Holding Register	7301-7316	val_utf8	String description (32 Bytes, UTF8, NULL terminated)	YES	YES	YES	YES
Regulator - P value	R/W	Holding Register	07317	val_d2_fp10	Proportional gain of temperature regulator	YES	YES	YES	YES
Regulator - I value	R/W	Holding Register	07318	val_u2	Integrating time of temperature regulator	YES	YES	YES	YES
Regulator - Hysteresis	R/W	Holding Register	07319	val_d2_fp100	Hysteresis	YES	YES	YES	YES
Heat curve - type	R/W	Holding Register	07320	val_u1	0 MANUAL 1 CALCULATED 2 UNDERFLOOR 3 RADIATORS	YES	YES	YES	YES
Heat curve - manual slope	R/W	Holding Register	07321	val_d2_fp10	Curve slope. Used only in MANUAL	YES	YES	YES	YES
Heat curve - parallel displacement	R/W	Holding Register	07322	val_d2_fp100	Shifts calculated temperature up/down	YES	YES	YES	YES
Heat curve - min inlet	R/W	Holding Register	07323	val_d2_fp100	Lowest possible temperature	YES	YES	YES	YES
Heat curve - max inlet	R/W	Holding Register	07324	val_d2_fp100	Highest possible temperature	YES	YES	YES	YES
Heat curve - gain	R/W	Holding Register	07325	val_d2_fp10	Static gain of desired temperature calculation	YES	YES	YES	YES
Return temp limiter - function	R/W	Holding Register	07326	val_u1	0 OFF 1 MIN 2 MAX	YES	YES	YES	YES
Return temp max limiter - Limit	R/W	Holding Register	07327	val_d2_fp100	Maximum allowed return temperature (limits inlet temperature)	YES	YES	YES	YES
Return temp max limiter - Gain	R/W	Holding Register	07328	val_d2_fp10	Return limiter proportional gain. Use high value fast acting system, low value for slow acting system.	YES	YES	YES	YES
Return temp max limiter - Priority over inlet	R/W	Holding Register	07329	val_u1	0 NO_PRIORITY 1 PRIORITY (return limiter can override "Heat curve - min inlet")	YES	YES	YES	YES
Return temp min limiter - Limit	R/W	Holding Register	07330	val_d2_fp100	Minimal allowed return temperature (limits inlet temperature)	YES	YES	YES	YES
Return temp min limiter - Gain	R/W	Holding Register	07331	val_d2_fp10	Return limiter proportional gain. Use high value fast acting system, low value for slow acting system.	YES	YES	YES	YES
Optimization - boost	R/W	Holding Register	07332	val_u1	Boost desired temperature by "Optimization - boost percent" for 1 hour 0 DISABLED 1 ENABLED	YES	YES	YES	YES
Optimization - boost percent	R/W	Holding Register	07333	val_u1	Boost percent	YES	YES	YES	YES
Optimization - ramping	R/W	Holding Register	07334	val_u1	Rise desired temperature over ramping time. 0 DISABLED 1 ENABLED	YES	YES	YES	YES
Optimization - ramping time	R/W	Holding Register	07335	val_u1	Ramping time	YES	YES	YES	YES
Frost protection - Mode	R/W	Holding Register	07336	val_u1	Activate heating in assigned loops when inlet temperature drops below "Frost protection - Temp"	YES	YES	YES	YES
Frost protection - Temp	R/W	Holding Register	07337	val_d2_fp100	Frost protection limit	YES	YES	YES	YES

	High Temp Cut-Off - Mode	R/W	Holding Register	07338	val_u1	Heating is blocked, when inlet temperature exceeds the limit. Alarm is raised, pump is switched off (ignoring all pump delay). 0 DISABLED 1 ENABLED	YES	YES	YES	YES
	High Temp Cut-Off - Temp	R/W	Holding Register	07339	val_d2_fp100	Limit temperature for High Temp Cut-Off	YES	YES	YES	YES
	Cooling Regulator - P value	R/W	Holding Register	07340	val_d2_fp10	Proportional gain of temperature regulator in cooling mode	-	YES	YES	YES
	Cooling Regulator - I value	R/W	Holding Register	07341	val_u2	Integrating time of temperature regulator in cooling mode	-	YES	YES	YES
	Cooling Regulator - Hysteresis	R/W	Holding Register	07342	val_d2_fp100	Hysteresis in cooling mode	-	YES	YES	YES
	Cooling inlet temp min	R/W	Holding Register	07343	val_d2_fp100	Lowest possible temperature in cooling mode	-	YES	YES	YES
	Cooling inlet temp max	R/W	Holding Register	07344	val_d2_fp100	Highest possible temperature in cooling mode	-	YES	YES	YES
ITC2	Same as ITC1			074xx			YES	YES	YES	YES
HCC CONTROLLERS										
HCC1										
	Aggregated warning	R	Discrete Inputs	07701		A problem is pending in ITC	YES	YES	YES	YES
	Aggregated error	R	Discrete Inputs	07702		A critical problem is pending in ITC	YES	YES	YES	YES
	Error - inlet sensor failure		Discrete Inputs	07703			YES	YES	YES	YES
	Error - High temp cut-off activated	R	Discrete Inputs	07704		Safety mechanism "high temp cut-off" is activated	YES	YES	YES	YES
	State	R	Input Register	07701	val_d1	1 IDLE 2 HEATING 3 COOLING 4 BLOCKED_HEATING 5 BLOCKED_COOLING	CHANGED	YES	YES	YES
	Blocking source	R	Input Register	07702	val_u1	Same as Heating/Cooling blocking source	YES	YES	YES	YES
	Pump - Demand	R	Input Register	07703	val_u1	1 IDLE 2 ON	YES	YES	YES	YES
	Pump - State	R	Input Register	07704	val_u1	1 IDLE 2 ON	YES	YES	YES	YES
	Measured inlet temperature	R	Input Register	07705	val_d2_fp100	Measured temperature of the inlet heating/cooling water.	YES	YES	YES	YES
	Desired inlet temperature	R	Input Register	07706	val_d2_fp100	Desired temperature of the inlet heating/cooling water. The value which the ITC regulator wants to meet.	YES	YES	YES	YES
	Name	R/W	Holding Register	07701-07716	val_utf8	String description (32 Bytes, UTF8, NULL terminated)	YES	YES	YES	YES
	Heat curve - type	R/W	Holding Register	07717	val_u1	0 MANUAL 1 CALCULATED 2 UNDERFLOOR 3 RADIATORS	YES	YES	YES	YES
	Heat curve - manual slope	R/W	Holding Register	07718	val_d2_fp10	Curve slope. Used only in MANUAL	YES	YES	YES	YES
	Heat curve - parallel displacement	R/W	Holding Register	07719	val_d2_fp100	Shifts calculated temperature up/down	YES	YES	YES	YES
	Heat curve - min inlet	R/W	Holding Register	07720	val_d2_fp100	Lowest possible temperature	YES	YES	YES	YES
	Heat curve - max inlet	R/W	Holding Register	07721	val_d2_fp100	Highest possible temperature	YES	YES	YES	YES
	Heat curve - gain	R/W	Holding Register	07722	val_d2_fp10	Static gain of desired temperature calculation	YES	YES	YES	YES
	High Temp Cut-Off - Mode	R/W	Holding Register	07723	val_u1	Heating is blocked, when inlet temperature exceeds the limit. Alarm is raised, pump is switched off (ignoring all pump delay). 0 DISABLED 1 ENABLED	YES	YES	YES	YES
	High Temp Cut-Off - Temp	R/W	Holding Register	07724	val_d2_fp100	Limit temperature for High Temp Cut-Off	YES	YES	YES	YES
HCC2	same as HCC1			078xx			YES	YES	YES	YES
HCC3	same as HCC1			079xx			-	YES	YES	YES
H/C Source										
H/C Source										
	Aggregated warning	R	Discrete Inputs	08101		A problem is pending in H/C Source	-	YES	YES	YES
	Aggregated error	R	Discrete Inputs	08102		A critical problem is pending in H/C Source	-	YES	YES	YES
	Error general failure	R	Discrete Inputs	08103		General failure	-	YES	YES	YES
	State	R	Input Register	08101	val_d1	1 IDLE 2 HEATING 3 COOLING 4 BLOCKED_HEATING 5 BLOCKED_COOLING	-	YES	YES	YES
PERIPHERAL LIST										
Peripheral 1										
	Aggregated warning	R	Discrete Inputs	51201		A problem is pending in Room	YES	YES	YES	YES
	Aggregated error	R	Discrete Inputs	51202		A critical problem is pending in Room	YES	YES	YES	YES
	Warning - low battery	R	Discrete Inputs	51203		Battery is low in the peripheral.	YES	YES	YES	YES
	Error - peripheral lost	R	Discrete Inputs	51204		Peripheral is not responding.	YES	YES	YES	YES
	Type	R	Input Register	51201	val_u2	Peripheral type - Sensor, Thermostat, ... (product number)	YES	YES	YES	YES
	SN	R	Input Register	51202-51203	val_u4	Serial number	YES	YES	YES	YES
	Owner	R	Input Register	51204	val_u2	000 - Location 001 - Room 1 ... 016 - Room 16 NOTE: Object address in this modbus table is used as owner_id	YES	YES	YES	YES
	Signal strength	R	Input Register	51205	val_d1	Peripheral Signal strength	YES	YES	YES	YES
	Peripheral name	R/W	Holding register	51201 - 51216	val_utf8	String description (32 Bytes, UTF8, NULL terminated)	YES	YES	YES	YES
Peripheral 2				513xx						
Peripheral 3				514xx						
...										
Peripheral 2-64				575xx						
EXTERNAL DEVICES - Ventilation (see note)										
Ventilation 1										
	Aggregated warning	R	Discrete Inputs	61001		A problem is pending in device	-	-	-	YES
	Aggregated error	R	Discrete Inputs	61002		A critical problem is pending in device	-	-	-	YES
	Warning - air filter lifetime expired	R	Discrete Inputs	61003		Air filter lifetime expired	-	-	-	YES
	Warning - air filter solar year passed	R	Discrete Inputs	61004		Air filter solar year passed from last air filter change	-	-	-	YES
	Warning - device specific	R	Discrete Inputs	61005		Read code from input register - Warning-device-specific	-	-	-	YES
	Error - device fault	R	Discrete Inputs	61006		General problem	-	-	-	YES
	Error - communication error	R	Discrete Inputs	61007		Communication error	-	-	-	YES
	Error - not compatible	R	Discrete Inputs	61008		Not compatible	-	-	-	YES
	Error - device specific	R	Discrete Inputs	61009		Read code from input register - Error-device-specific	-	-	-	YES
	Device model	R	Input Register	61001-61016	val_utf8	Device model	-	-	-	YES
	Warning - device specific code	R	Input Register	61017-61018	val_u4	Device specific warning code	-	-	-	YES
	Error - device specific code	R	Input Register	61019-61020	val_u4	Device specific error code	-	-	-	YES
	Device feature bits	R	Input Register	61021-61022	val_u4	Specific features (capabilities) device has 0x0001 - ALLOW_UNOCCUPIED 0x0002 - ALLOW_ECO 0x0004 - ALLOW_COMFORT 0x0008 - ALLOW_STOPPED 0x0010 - ALLOW_BOOST 0x0020 - ALLOW_BYPASS 0x0040 - FAN_PWM_CONTROL 0x0080 - FAN_BINARY_CONTROL 0x0100 - TEMP_INTAKE 0x0200 - TEMP_SUPPLY 0x0400 - TEMP_EXTRACT 0x0800 - TEMP_EXHAUST 0x1000 - HUMIDITY_INTAKE 0x2000 - HUMIDITY_EXTRACT 0x4000 - FAN_SPEED_FEEDBACK	-	-	-	YES

Note: Ventilation devices are connected using the Modbus RTU master function, this means for a Modbus slave connection only the TCP/IP option is available. More info in the TCP/IP chapter of this manual.

Ventilation state	R	Input Register	61023	val_u1	0 - STOPPED 1 - UNOCCUPIED 2 - ECONOMY 3 - COMFORT 4 - BOOST 5 - BLOCKED_STOPPED 6 - BLOCKED_UNOCCUPIED 7 - BLOCKED_ECONOMY 8 - BLOCKED_COMFORT 9 - BLOCKED_BOOST 10 - FAILURE 11 - MAINTENANCE	-	-	-	YES
Ventilation blocking	R	Input Register	61024	val_u1	Please check top of the document - GENERAL BLOCKING SOURCES	-	-	-	YES
Supply fan speed actual [rpm]	R	Input Register	61025	val_u2	Supply fan speed actual [rpm]	-	-	-	YES
Exhaust fan speed actual [rpm]	R	Input Register	61026	val_u2	Exhaust fan speed actual [rpm]	-	-	-	YES
Supply fan speed setpoint [%]	R	Input Register	61027	val_d2_fp100	Supply fan speed setpoint [%]	-	-	-	YES
Exhaust fan speed setpoint [%]	R	Input Register	61028	val_d2_fp100	Exhaust fan speed setpoint [%]	-	-	-	YES
Supply volume flow setpoint [m³/h]	R	Input Register	61029	val_u2	Supply volume flow setpoint [m³/h]	-	-	-	YES
Exhaust volume flow setpoint [m³/h]	R	Input Register	61030	val_u2	Exhaust volume flow setpoint [m³/h]	-	-	-	YES
Intake air temperature	R	Input Register	61031	val_d2_fp100	Intake air temperature	-	-	-	YES
Supply air temperature	R	Input Register	61032	val_d2_fp100	Supply air temperature	-	-	-	YES
Extract air temperature	R	Input Register	61033	val_d2_fp100	Extract air temperature	-	-	-	YES
Exhaust air temperature	R	Input Register	61034	val_d2_fp100	Exhaust air temperature	-	-	-	YES
Heat recovery bypass damper position [%]	R	Input Register	61035	val_d2_fp100	Heat recovery bypass damper position [%]	-	-	-	YES
Free cooling enabled	R	Input Register	61036	val_u1	Free cooling enabled	-	-	-	YES
Air filter last change	R	Input Register	61037-61038	val_u4	Timestamp, updates when register "Air filter lifetime used" is set to zero	-	-	-	YES

Device name	R/W	Holding register	61001-61016	val_utf8	String description (32 Bytes, UTF8, NULL terminated)	-	-	-	YES
Air filter lifetime	R/W	Holding Register	61017-61018	val_u4	Air filter lifetime (minutes) - maximum value is dependent on device model	-	-	-	YES
Air filter lifetime used	R/W	Holding Register	61019-61020	val_u4	Write 0 to reset timer	-	-	-	YES
Exhaust Fan Level Unoccupied [%]	R/W	Holding register	61021	val_d2_fp100	Exhaust Fan Level Unoccupied [%]	-	-	-	YES
Exhaust Fan Level Eco [%]	R/W	Holding register	61022	val_d2_fp100	Exhaust Fan Level Eco [%]	-	-	-	YES
Exhaust Fan Level Comfort [%]	R/W	Holding register	61023	val_d2_fp100	Exhaust Fan Level Comfort [%]	-	-	-	YES
Exhaust Fan Level Boost [%]	R/W	Holding register	61024	val_d2_fp100	Exhaust Fan Level Boost [%]	-	-	-	YES
Supply Fan Level Unoccupied [%]	R/W	Holding register	61025	val_d2_fp100	Supply Fan Level Unoccupied [%]	-	-	-	YES
Supply Fan Level Eco [%]	R/W	Holding register	61026	val_d2_fp100	Supply Fan Level Eco [%]	-	-	-	YES
Supply Fan Level Comfort [%]	R/W	Holding register	61027	val_d2_fp100	Supply Fan Level Comfort [%]	-	-	-	YES
Supply Fan Level Boost [%]	R/W	Holding register	61028	val_d2_fp100	Supply Fan Level Boost [%]	-	-	-	YES
Exhaust Fan Level Unoccupied [m³/h]	R/W	Holding register	61029	val_u2	Exhaust Fan Level Unoccupied [m³/h]	-	-	-	YES
Exhaust Fan Level Eco [m³/h]	R/W	Holding register	61030	val_u2	Exhaust Fan Level Eco [m³/h]	-	-	-	YES
Exhaust Fan Level Comfort [m³/h]	R/W	Holding register	61031	val_u2	Exhaust Fan Level Comfort [m³/h]	-	-	-	YES
Exhaust Fan Level Boost [m³/h]	R/W	Holding register	61032	val_u2	Exhaust Fan Level Boost [m³/h]	-	-	-	YES
Supply Fan Level Unoccupied [m³/h]	R/W	Holding register	61033	val_u2	Supply Fan Level Unoccupied [m³/h]	-	-	-	YES
Supply Fan Level Eco [m³/h]	R/W	Holding register	61034	val_u2	Supply Fan Level Eco [m³/h]	-	-	-	YES
Supply Fan Level Comfort [m³/h]	R/W	Holding register	61035	val_u2	Supply Fan Level Comfort [m³/h]	-	-	-	YES
Supply Fan Level Boost [m³/h]	R/W	Holding register	61036	val_u2	Supply Fan Level Boost [m³/h]	-	-	-	YES
Allow Stopped level	R/W	Holding register	61037	val_u1	Allow Stopped level 0 - NOT ALLOWED 1 - ALLOWED	-	-	-	YES
Allow Unoccupied level	R/W	Holding register	61038	val_u1	Allow Unoccupied level 0 - NOT ALLOWED 1 - ALLOWED	-	-	-	YES
Standby mode level	R/W	Holding register	61039	val_u1	0 - STOPPED 1 - UNOCCUPIED 2 - ECONOMY	-	-	-	YES
Vacation mode level	R/W	Holding register	61040	val_u1	0 - STOPPED 1 - UNOCCUPIED 2 - ECONOMY	-	-	-	YES
Heat exchange mode (recovery bypass)	R/W	Holding register	61041	val_u1	0 - ALWAYS ON 1 - AUTOMATIC	-	-	-	YES
Ventilation 2 reserved			611xx-613xx			-	-	-	YES

EXTERNAL DEVICES - Dehumidifier									
Dehumidifier Device 1									
Aggregated warning	R	Discrete Inputs	65001		A problem is pending in device	-	YES	YES	YES
Aggregated error	R	Discrete Inputs	65002		A critical problem is pending in device	-	YES	YES	YES
Warning - air filter lifetime expired	R	Discrete Inputs	65003		Air filter lifetime expired	-	YES	YES	YES
Warning - air filter solar year passed	R	Discrete Inputs	65004		Air filter solar year passed from last air filter change	-	YES	YES	YES
Error - HCW supplier	R	Discrete Inputs	65005		Heating/Cooling water supplier is not set	-	YES	YES	YES
Error - device fault	R	Discrete Inputs	65006		Device fault - general signal from device	-	YES	YES	YES
Type	R	Input Register	65001	val_u1	Device type 0 GENERIC 1 P300_S300 2 PC300_SC300	-	YES	YES	YES
Drying status	R	Input Register	65003	val_u1	0 NONE (function not available) 1 IDLE 2 DRYING 3 BLOCKED_DRYING	-	YES	YES	YES
Drying blocking	R	Input Register	65004	val_u1	Please check top of the document - GENERAL BLOCKING SOURCES	-	YES	YES	YES
Thermal integration status	R	Input Register	65005	val_u1	0 NONE (function not available) 1 IDLE 2 HEATING 3 COOLING 4 BLOCKED_HEATING 5 BLOCKED_COOLING	-	YES	YES	YES
Thermal integration blocking	R	Input Register	65006	val_u1	Please check top of the document - GENERAL BLOCKING SOURCES	-	YES	YES	YES
Thermal Integ. demand condition	R	Holding Register	65007	val_u1	100 - IN ANY ROOM 101 - IN ALL ROOMS 1-32 - PARTICULAR ROOM (Address of modbus object)	-	YES	YES	YES
Air filter last change	R	Input Register	65010-11	val_u4	Timestamp, updates when register "Air filter lifetime used" is set to zero	-	YES	YES	YES
Associated HCW supplier	R	Input Register	65012	val_u1	0 - NONE 73 .. TC1 (Address of modbus object) 74 .. TC2 (Address of modbus object) 77 .. HCC1 (Address of modbus object) 78 .. HCC2 (Address of modbus object) 79 .. HCC3 (Address of modbus object) 81 .. H/C Source (Address of modbus object)	-	YES	YES	YES

	Device name	R/W	Holding register	65001-65016	val_utf8	String description (32 Bytes, UTF8, NULL terminated)	-	YES	YES	YES
	Air filter lifetime	R/W	Holding Register	65017-65018	val_u4	Air filter lifetime (minutes)	-	YES	YES	YES
	Air filter lifetime used	R/W	Holding Register	65019-65020	val_u4	Write 0 to reset timer	-	YES	YES	YES
	Drying allow in mode	R/W	Holding Register	65021	val_u1	0 - IN COOLING MODE 1 - IN HEATING MODE 2 - IN BOTH	-	YES	YES	YES
	Drying cooling water	R/W	Holding Register	65022	val_d2_fp100	Desired cooling water temperature	-	YES	YES	YES
	Thermal integ. allow in mode	R/W	Holding Register	65023	val_u1	0 - IN COOLING MODE 1 - IN HEATING MODE 2 - IN BOTH	-	YES	YES	YES
	Thermal integ. heating water temp	R/W	Holding Register	65024	val_d2_fp100	Desired heating water temperature	-	YES	YES	YES
	Thermal integ. cooling water temp	R/W	Holding Register	65025	val_d2_fp100	Desired cooling water temperature	-	YES	YES	YES
	Dehumidifier Device 2			651xx			-	YES	YES	YES
	Dehumidifier Device 3			652xx			-	YES	YES	YES
	Dehumidifier Device 4			653xx			-	YES	YES	YES
	GENERAL BLOCKING SOURCES									
	0 NONE					Purpose of the modbus interface (Use cases)				
	1 UNKNOWN					* it is NOT a user interface				
	2 CONTACT					* it is NOT an installer interface				
	3 FLOOR_TEMP					* It shall allow following:				
	4 LOW_ENERGY					1. See all warnings and errors				
	5 AIR_TEMP					2. Optimize the system by expert (tuning)				
	6 DEW_POINT					a. Power consumption				
	7 OUTDOOR_TEMP					b. Reliability				
	8 FAULT (general fault, e.g. missing sensors)					c. Suppress activity of system parts (e.g. circulation)				
	9 FAULT_HTCO					3. Restrict user possibilities & reset user settings				
	10 PERIODIC_ACTIVATION					a. Set UI access levels				
	11 BMS					b. Reset temperature correction made by user (hotel)				
	12 DEADBAND					c. Basic setup - manual control				
	13 DRYING									
	14 HEATING/COOLING MODE									
	15 INSUFFICIENT DEMAND									
	16 COOLDOWN PERIOD									
	17 HCW SOURCE NOT RELEASED									
	18 ROOM MODE									
	19 SYSTEM IS INITIALIZING									
	20 SYSTEM IS SHUTTING DOWN									
	21 NO OUTPUT									
	22 FIRST OPEN ACTIVATION									
	23 ROOM WITH NO TEMPERATURE									
	The number of blocking sources is still growing. There can be another values than listed in this documentation.									

General blocking sources

Table 1

- 1 UNKNOWN
- 2 CONTACT
- 3 FLOOR_TEMP
- 4 LOW_ENERGY
- 5 AIR_TEMP
- 6 DEW_POINT
- 7 OUTDOOR_TEMP
- 8 FAULT (general fault, e.g. missing sensors)
- 9 FAULT_HTCO
- 10 PERIODIC_ACTIVATION
- 11 BMS
- 12 DEADBAND
- 13 DRYING
- 14 HEATING/COOLING MODE
- 15 INSUFFICIENT DEMAND
- 16 COOLDOWN PERIOD
- 17 HCW SOURCE NOT RELEASED
- 18 ROOM MODE
- 19 SYSTEM IS INITIALIZING
- 20 SYSTEM IS SHUTTING DOWN
- 21 NO OUTPUT
- 22 FIRST OPEN ACTIVATION
- 23 ROOM WITH NO TEMPERATURE

The number of blocking sources is still growing.
There can be another values than listed in this documentation.

Purpose of the modbus interface

(Use cases)

- * it is NOT a user interface
- * it is NOT an installer interface
- * It shall allow following:
 1. See all warnings and errors
 2. Optimize the system by expert (tuning)
 - a. Power consumption
 - b. Reliability
 - c. Suppress activity of system parts (e.g. circulation)
 3. Restrict user possibilities & reset user settings
 - a. Set UI access levels
 - b. Reset temperature correction made by user (hotel)
 - c. Basic setup - manual control

NOTE: Ventilation devices are connected using the Modbus RTU master function, this means for a Modbus slave connection only the TCP/IP option is available. More info in the TCP/IP chapter of this manual.

Value Component type

Table 2

0	Calefa controller
4	Sentio Display
5	Sentio Wired room thermostat
6	Sentio Wireless room thermostat
7	Sentio wired room sensor
8	Sentio wireless room sensor
9	Sentio wireless room thermostat w/IR-sensor
10	Sentio Extension module f/8 actuators
11	Sentio Extension module w/6 relays
12	Sentio wireless outdoor temperature sensor
13	Sentio wired outdoor temperature sensor
14	Sentio Smart radiator thermostat

List of supported IANA time zones

Table 3

Area/Town	UTC offset	Zone number
Factory		0
Europe/Amsterdam	+01:00	1024
Europe/Astrakhan	+04:00	1025
Europe/Berlin	+01:00	1026
Europe/Bratislava	+01:00	1027
Europe/Brussels	+01:00	1028
Europe/Budapest	+01:00	1029
Europe/Copenhagen	+01:00	1030
Europe/Dublin	+00:00	1031
Europe/Helsinki	+02:00	1032
Europe/Istanbul	+03:00	1033
Europe/Kaliningrad	+02:00	1034
Europe/Kirov	+03:00	1035
Europe/London	+00:00	1036
Europe/Madrid	+01:00	1037
Europe/Moscow	+03:00	1038
Europe/Oslo	+01:00	1039
Europe/Paris	+01:00	1040
Europe/Prague	+01:00	1041
Europe/Riga	+02:00	1042
Europe/Rome	+01:00	1043
Europe/Samara	+04:00	1044
Europe/Saratov	+04:00	1045
Europe/Stockholm	+01:00	1046
Europe/Ulyanovsk	+04:00	1047
Europe/Vilnius	+02:00	1048
Europe/Volgograd	+03:00	1049
Europe/Warsaw	+01:00	1050
Atlantic/Faroe	+00:00	2048
Atlantic/Reykjavik	+00:00	2049
America/Cancun	-05:00	3072

Area/Town	UTC offset	Zone number
Factory		0
America/Chihuahua	-07:00	3073
America/Danmarkshavn	+00:00	3074
America/Godthab	-03:00	3075
America/Hermosillo	-07:00	3076
America/Matamoros	-06:00	3077
America/Mexico_City	-06:00	3078
America/Ojinaga	-07:00	3079
America/Scoresbysund	-01:00	3080
America/Thule	-04:00	3081
America/Tijuana	-08:00	3082
Asia/Anadyr	+12:00	4096
Asia/Barnaul	+07:00	4097
Asia/Chita	+09:00	4098
Asia/Irkutsk	+08:00	4099
Asia/Kamchatka	+12:00	4100
Asia/Khandyga	+09:00	4101
Asia/Krasnoyarsk	+07:00	4102
Asia/Magadan	+11:00	4103
Asia/Novokuznetsk	+07:00	4104
Asia/Novosibirsk	+07:00	4105
Asia/Omsk	+06:00	4106
Asia/Sakhalin	+11:00	4107
Asia/Srednekolymsk	+11:00	4108
Asia/Tomsk	+07:00	4109
Asia/Ust-Nera	+10:00	4110
Asia/Vladivostok	+10:00	4111
Asia/Yakutsk	+09:00	4112
Asia/Yekaterinburg	+05:00	4113

Factory timezone

Factory timezone is read-only. It is used for compatibility reasons. E.g. When updating from SW which didnt support timezones. UTC offset is last known, DST rules are same as for Europe. When Factory is set, you should change it to supported timezone.

9. Technical specifications

Usable in all Europe 

9.1. Technical specifications Central Control Unit (CCU)

General

Power supply	195 – 250 V AC, typically 230 V AC
Current consumption	0,25 A max., 6 mA standby
Communication band	868,5 MHz
Communication range	Up to 500m (line of sight)
Control range temperature inputs (T1-T5)	30T105 (-30 - 105 °C), NTC10k B3977
Backup battery (inside CCU near fuse)	CR2032
Dimensions	230 x 110 x 54 mm
Weight	825 g (775 g without plug)
Fuse	T1.6A/250 V size 5 x 20 mm
Protection	IP 31 (EN 60529)
Mechanical resistance	IK 07 (EN 50102)
Operation environment	T40 (0 - 40 °C) indoor general, without condensation
Storage Conditions	-10°C to 50°C, 5% to 95% relative humidity, without condensation
Complies with	EN 62311:2008 (2004/40/EC), ETSI EN 300 220-2 V3.1.1.2017, EN 60730-1:2011, EN 60730-2-9:2011, EN 55032:2015 / Cor. 1:2018, EN 55024:2010 / A1:2015, EN 50581:2012, Directive 2014/53/EU, Directive 2014/35/EU, Directive 2014/30/EU, Directive 2011/65/EU, Directive 2009/125/EU, (EU) No 813/2013, (EU) No 81172013 EU-bac license



Outputs

RS485 (ROXi BUS) Terminal +RJ45	24 V DC / 1,5 A (current in all buses)*
Valve (S1,S3,S2,S4)	24 V DC / 100 mA (power outputs = 3 point mode)
Valve (S1,S3)	0 – 10 V DC/ 2 mA (analog outputs)
Actuators outputs	24 V DC / 170 mA max., 85 mA typically
GPO 1,2 outputs	5 – 24 V DC / 100 mA open drain, shortcut protection
Relay VFR	230 V AC/ 1 A max.
Relays ITC Pumps	1 A max., 230 V AC from power supply

*RJ45 (100mA) is not recommended for power supply



Application: Water Floor Heating Systems
License no: 219870
Control Accuracy CA=0,5°C

9.2. Technical specifications Extension Unit A

General

Power supply	20 – 25 V DC, typically 24 V DC (ROXi BUS)
Current consumption	20 mA max., 2 mA standby (Actuators off)
Dimensions	90 x 110 x 54mm
Weight	220 g
Protection	IP 31 (EN 60529)
Mechanical resistance	IK 07 (EN50102)
Operation environment	T40 (0 - 40°C) indoor general, without condensation
Storage Conditions	-10°C to 50°C, 5% to 95% relative humidity, without condensation
Complies with	EN 62368-1:2014, EN 60730-1:2011, EN 55032:2012, EN 55024:2010 / A1:2015, EN 50581:2012, Directive 2014/35/EU, Directive 2014/30/EU, Directive 2011/65/EU



Outputs

RS485 (ROXi BUS) Terminal +RJ45	24 V DC / 1,5 A (current in all buses)*
Actuator outputs 9-16	24 V DC / max 300mA or relay 24V max 50mA

*RJ45 is not recommended to use these terminals for current drawing higher than 100mA

9.3. Technical specifications Extension Unit VFR

General

Power supply	20 – 25 V DC, typically 24 VDC (ROXiBUS)
Current consumption	0,06 A max., 5 mA standby (relays off)
Dimensions	90 x 110 x 54mm
Weight	220 g
Protection	IP 31 (EN 60529)
Mechanical resistance	IK 07 (EN50102)
Operation environment	T40 (0 - 40°C) indoor general, without condensation
Storage Conditions	-10°C to 50°C, 5% to 95% relative humidity, without condensation
Complies with	EN 62368-1:2014, EN 60730-1:2011, EN 55032:2012, EN 55024:2010 / A1:2015, EN 50581:2012, Directive 2014/35/EU, Directive 2014/30/EU, Directive 2011/65/EU



Outputs

RS485 (ROXi BUS) Terminal +RJ45	24 V DC / 1,3 A (current in all buses)
Relays A-B	24 V AC/DC 1 A max, Voltage free relay
Relays C-F	230 V AC/ 24 V DC 1 A max, Voltage free relay

*RJ45 is not recommended to use these terminals for current drawing higher than 100mA

9.4. Technical specifications Wireless thermostat, Wireless thermostat with infrared floor sensor and Wireless sensor

Power supply	2,2 V – 3,5 V, typically 3 V (2xAA 1,5 V alkaline batteries)
Battery service life	Typically 2 years
Max. device consumption	Wireless thermostat, wireless thermostat with infrared floor sensor: 150 mA (fully illuminated display) Wireless sensor: 40 mA
Communication band	868,5 MHz
Communication range	Up to 100m (line of sight)
Control range air temperature	T50 (0 - 50°C), accuracy $\pm 0,5$ °C, step 0,1 °C
Control range floor temperature	Wireless thermostat with infrared floor sensor: T40 (0 - 40°C) accuracy ± 1 °C at 25 °C, step 0,1 °C
Control range humidity	10 – 90 % rH, accuracy ± 3 % rH, step 1 % rH
Dimensions	62 x 85 x 22mm
Protection	IP 31 (EN 60529)
Operation environment	T40 (0-40°C), indoor general, without condensation
Storage Conditions	-10°C to 50°C, 5% to 95% relative humidity, without condensation Storage temperature including batteries +5°C to +30°C
Complies with	EN 62368-1:2014 / Cor 1:2015 / A11:2017, EN 62311:2008 (2004/40/EC), ETSI EN 300 220-2 V3.1.1.2017, EN 60730-1:2011, EN 55032:2012, EN 55024:2010 / A1:2015, EN 50581:2012, Directive 2015/53/EU, Directive 2014/35/EU, Directive 2014/30/EU, Directive 2011/65/EU EU-bac license



9.5. Technical specifications Wired thermostat, wired sensor

Power supply	8 to 30 V DC, typically 24 V DC
Max. device consumption	2 mA (24 V DC/ minimum use of the thermostat) 30 mA (24 V DC/fully illuminated display)
Control range air temperature	T50 (0 - 50°C), accuracy $\pm 0,5$ °C, step 0,1 °C
Control range floor temperature	T40 (0 - 40°C), accuracy ± 1 °C, step 0,1 °C
Control range humidity	10 – 90 % rH, accuracy ± 3 % rH, step 1 % rH
Dimensions	62 x 85 x 22mm
Protection	IP 31 (EN 60529)
Operation environment	T40 (0 - 40 °C) indoor general, without condensation
Storage Conditions	-10°C to 50°C, 5% to 95% relative humidity, without condensation
Complies with	EN 60730-1:2011, EN 55032:2012, EN 55024:2010 / A1:2015, EN 50581:2012, Directive 2014/30/EU, Directive 2011/65/EU EU-bac license



9.6. Technical specifications Wireless outdoor sensor

Power supply	2,0-3,5V (3,0V Lithium battery type CR123A, 2 can be connected in parallel)
Battery service life	Typically 4 years (one battery) / 10 years (two batteries) Default one battery
Max. device consumption	50 mA, 20 μ A Standby
Communication band	868,5 MHz
Communication range	Up to 200m (open area)
Control range temperature	25T60 (-25°C to +60°C)
Operational temperature	25T60 (-25°C to +60°C) (recommended for CR123A)
Dimensions	90 x 110 x 35mm
Weight	145g (without batteries)
Protection	IP53 (EN 60529)
Operation environment	humidity 0-99%, outdoor, no condensation
Storage Conditions	-10°C to 50°C, 5% to 95% relative humidity, without condensation Storage temperature including batteries +5°C to +30°C
Complies with	EN 62368-1:2014 / Cor 1:2015/A11:2017, ETSI EN 300 220-2 V3.1.1.2017, EN 60730-1:2011, EN 55032:2012, EN 55024:2010 / A1:2015, EN 50581:2012, Directive 2014/53/EU, Directive 2014/35/EU, Directive 2014/30/EU, Directive 2011/65/EU



An external sensor (type PT 1000) can be complemented to enlarge the temperature control range from -50 °C to +200 °C (accuracy $\pm 1^\circ\text{C}$).

9.7. Technical specifications Wired outdoor sensor

Power supply	10 V DC-30 V DC, typically 24 V DC
Device consumption	Max. 2mA in standby mode Avg. 1,2mA with PT1000
Control range temperature	25T60 (-25°C to +60°C)
Operational temperature	40T70 (-40°C to +70°C)
Dimensions	90 x 110 x 35mm
Weight	125g
Protection	IP53 (EN 60529)
Operation environment	humidity 0-99%, outdoor, no condensation
Storage Conditions	10°C to 50°C, 5% to 95% relative humidity, without condensation
Complies with	EN 60730-1:2011, EN 55032:2012, EN 55024:2010 / A1:2015, EN 50581:2012, Directive 2014/30/EU, Directive 2011/65/EU



An external sensor (type PT 1000) can be complemented to enlarge the temperature control range from -50 °C to +200 °C (accuracy $\pm 1^\circ\text{C}$).

9.8. Technical specifications Smart Radiator Thermostat

Power supply	3,8 V - 5,0 V, typically 3 V (3 x AA Alkaline 1.5V Battery)
Battery service life	Up to 3 years
Communication band	868,5 MHz
Communication range	Up to 100m (line of sight)
Control range air temperature	T65 (0 - 65 °C), accuracy +0,5 °C, step 0,1 °C
Valve stroke	4.5 mm
Dimensions	L = 85 mm, ø = 50 mm
Protection	IP30
Operation environment	0 °C - 40 °C
Storage Conditions	-10°C to 50°C, 5% to 95% relative humidity, without condensation Storage temperature including batteries +5°C to +30°C
Complies with	ETSI EN 300 220-1 V3.1.1:2017; ETSI EN 300 220-2 V3.2.1:2018 EN 60730-1:2011; EN 60730-2-8 ed 2:2002/A1; EN 55016-2-3 ed.4:2017; EN 55032 ed 2:2016; EN 61000-4-2 3d 2:2008; EN 61000-4-3 ed 3:2006/ A1/A2; EN 61000-4-8 ed 2:2010; EN 61000-6-1 ed 3:2019; EN61000-6-3 ed 2: 2007/A1. Directive 2014/53/EU, Directive 2014/35/ EU, Directive 2014/30/EU, Directive 2011/65/EU



9.9. Technical specifications Actuators

Operating voltage	24V AC/DC, +20%...-10%
Max. inrush current	< 300mA during 2 min. max.
Operating power	1W
Stroke (actuator travel)	4mm (first open function)
Actuating force	100N ± 5%
Fluid temperature	0°C – 100°C
Type of protection	IP 54 / III
Connecting cable	2 x 0.75mm ²
Cable length	1 m
Surge protection according to EN 60730-1	Min. 2.5kV
Complies with	EN 60730



(The max. no. of actuators per CCU, incl. EU-A, is limited to 16 actuators.

Max. 2 actuators per channel for the CCU and max. 1 actuator for the EU-A to be connected.)

9.10. Technical specifications Wired floor sensor

Max. power consumption	15mW
Control range temperature	25T105 (-25°C to +105°C), accuracy ±1% in 25°C, ±2°C in the range of -25°C to 105°C)
Type of element	NTC 10kΩ, B25/100 = 3977K
Protection	IP67 (EN 60529)
Operation environment	humidity 10-100%, 70-106kPa
Housing	∅: 4,6±0,1mm Length: 25mm
Supply cable	Type: unshielded PVC 2x0,25mm ² Length: 3 m
Complies with	EN 50581:2012



9.11. Technical specifications External Antenna (3pin)

Communication band	866,5MHz
Antenna gain	max. 3dBi
Impedance	50Ω
Connection cable length	1,90m
Dimensions	130 x 50 x 30mm
Weight	140g
Operational temperature	-20°C to +60°C
Operation environment	humidity 0-90%, non-condensing
Complies with	EN 50581:2012, Directive 2011/65/EU



Discover our broad portfolio at wavin.com

- Water management
- Heating and cooling
- Water and gas distribution
- Waste water drainage

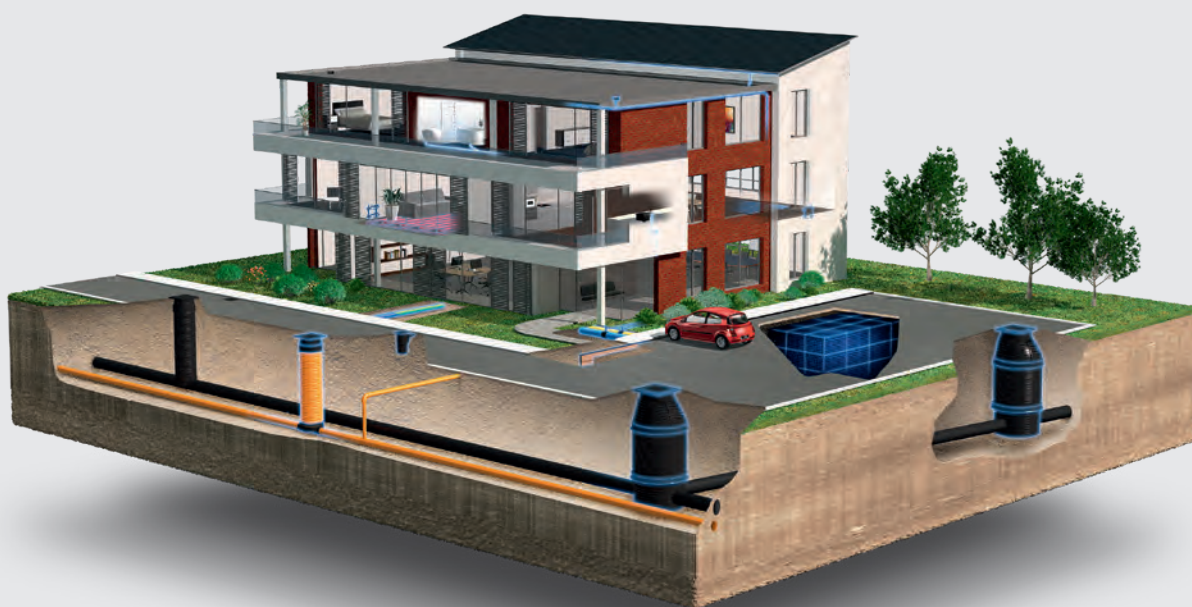

Wavin is part of Orbia, a community of companies working together to tackle some of the world's most complex challenges. We are bound by a common purpose: To Advance Life Around the World.



Orbia's Building and Infrastructure business Wavin is an innovative solutions provider for the global building and infrastructure industry. Backed by more than 60 years of product development experience, Wavin is advancing life around the world by building healthy, sustainable environments for global citizens. Whether it's to improve the distribution of clean drinking water, to make sanitation accessible for everyone, to create climate resilient cities, or to design comfortable living spaces, Wavin collaborates with municipal leaders, engineers, contractors, and installers to help future-proof communities, buildings and homes. Wavin has 12,000+ employees around 65 production sites worldwide, serving over 80 countries through a global sales and distribution network.

Wavin B.V. World Trade Center (WTC) | Wavin Tower F9 Schiphol Boulevard 425 |
1118 BK Schiphol The Netherlands | Internet www.wavin.com | E-mail info@wavin.com

© 2023 Wavin Wavin reserves the right to make alterations without prior notice. Due to continuous product development, changes in technical specifications may change. Installation must comply with the installation instructions.