



Product & Installation Manual

wavin **OSMA**

Soil and Waste

www.wavin.co.uk



Wavin Osma Soil and Waste

Above Ground Drainage Systems

Contents

Introduction to.....	2-7	Design	85-103
PVC-U Soil System.....	2-3	Typical Assembly.....	85
Waste and Overflow Systems	4-7	Applications.....	86
ABS Solvent Weld Waste System.....	4	Pipe Sizing	86
PP Push-Fit Waste System	5	Maximum Pipe Runs.....	87
V-Joint Traps.....	5	Thermal Movement	87
Condensate Drainage.....	5	Pipe Support	88
Solvent Weld Overflow System	6	Access.....	88
PP Push-fit Overflow System.....	6	Offsets.....	89
Hep _v O Hygienic Self-Sealing Waste Valves.....	7	Connections to Drainage.....	90-91
		Connections to Waste	92-94
System Selector.....	8-9	Connections to WC's.....	95-96
		WC Manifolds.....	97-98
Estimating Data	10	Ventilation.....	99-100
Estimating Data	10	Fire Stopping.....	101
Joining Material Allowances.....	10	Materials: Properties and Performance	102
		Handling, Storage and Safety	103
PVC-U Ring-Seal System.....	11-31	Installation.....	104-116
PVC-U Solvent Weld System.....	32-44	Pipe Cutting and Joining	104
WC Connectors.....	45-49	Acoustic Socket (4S125).....	104-105
Ancillaries	50-53	Solvent Weld Joining	106
ABS Solvent Weld Waste.....	54-60	Pipe Support and Offsets.....	107
Polypropylene Push-fit Waste	61-64	Connections to Below Ground	
Waste Connectors		Drainage	108-109
and V-Joint Traps	65-73	Access Saddle	109
Condensate Drainage.....	74-75	Soil Connections to Waste	110-111
Solvent Weld Overflow	76-78	Air Admittance Valves	112
Polypropylene Push-fit Overflow	79-80	Weatherproofing Soil Stack	113
Hep _v O Hygienic Self-Sealing		Traps.....	114
Waste Valves	81	Shower Gullies.....	115
		Overflows.....	115-116
Problem Solvers –		Maintenance, Repairs,	
Flexible Soil and Waste	82-83	Testing and Safety	117
Problem Solvers – Condensate.....	84	Maintenance.....	117
		Repairs	117
		Testing.....	117
		Safety.....	117
		General Information	118-119
		BIM Design	120

Introduction to Wavin OsmaSoil

PVC-U Soil System

Comprehensive Choice

The Wavin Osma soil and vent range offers an exceptional choice of pipe and fittings including brackets, bends, junctions, access fittings, terminations and problem solvers.

Available in a choice of colours (black, grey and white) and connection methods: Ring-Seal (push-fit) and Solvent Weld to give maximum installation flexibility.

- Ring-Seal (push-fit) pipe and fittings are available in 82/110/160mm sizes
- Solvent weld pipe and fittings are available in 110/160mm sizes



Specialist Seal Technology

OsmaSoil pipe and fittings have seals that always stay where they should; fittings via an innovative co-moulded seal and cap (captive seal), ensuring the seals do not dislodge and remain airtight. Socketed pipes have a co-moulded rubber and polypropylene ring which is retained inside the socket.



Unique Keyway

OsmaSoil fittings have a unique keyway. When the Boss Socket Adaptor is installed the locating key fits into the corresponding keyway on the fitting ensuring the correct fall is achieved every time.



High Performance Pipes with Recycled Content

All 110mm and 160mm plain ended and single socketed soil pipe in this range is manufactured using Wavin's award winning Recycore Technology and contains at least 50% recycled PVC. BS EN 1453-1 Kitemarked.

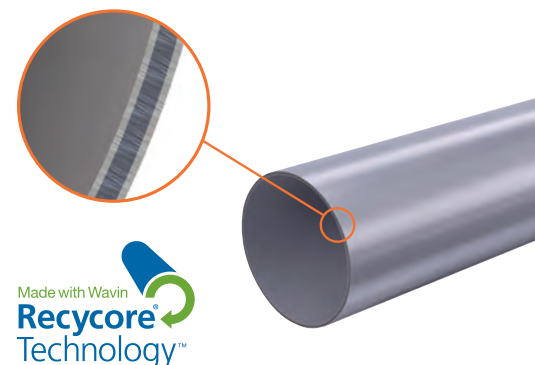

Commitment to Standards

Wavin is committed to manufacturing to the highest standards.

- OsmaSoil 82/110/160mm fittings and 82mm pipe are manufactured in PVC-U to BS EN 1329-1:2000
- OsmaSoil 110/160mm pipe is manufactured in PVC-U with Wavin's Recycore Technology to BS EN 1453-1:2000



Table 1: PVC-U Soil system: Pipe Dimensions (mm) and Weights (kg/m)

Nominal Size (mm)	Outside Diameter		Wall Thickness		Average
	Min	Max	Min	Max	Weight (kg/m)
82	82.4	82.8	3.3	3.5	1.22
110	110.0	110.3	3.2	3.5	1.64
160	160.0	160.4	3.2	3.8	2.44

Table 2: PVC-U Ring-Seal Soil system: Socket Dimensions (mm)

Nominal Size (mm)	Internal Depth		Maximum Outside Diameter	
	Ring-Seal	Solvent Weld	Ring-Seal	Solvent Weld
82	55	45	113	89
110	65	50	132	118
160	80	58	192	168

Table 3: PVC-U Solvent Weld Soil system: Socket Dimensions (mm)

Nominal Size (mm)	Internal Depth		Maximum Outside Diameter	
	Without Expansion Cap	With Expansion Cap	Without Expansion Cap	With Expansion Cap
110	48	65	121	126
160	58	86	172	177

Osma WC Connectors

Within OsmaSoil is a comprehensive set of WC fittings for all WC configurations, including easy fit, flexible pan connectors and manifold branches designed to connect up to 8 WCs to 1 float.

Specialist Fittings

Within OsmaSoil we offer you fittings designed to make installations easier. For example the 6-boss manifold has a compact design to sit in a 200mm hole with multiple waste connection options (without the need for boss adaptors) to give you maximum versatility in a restricted space.

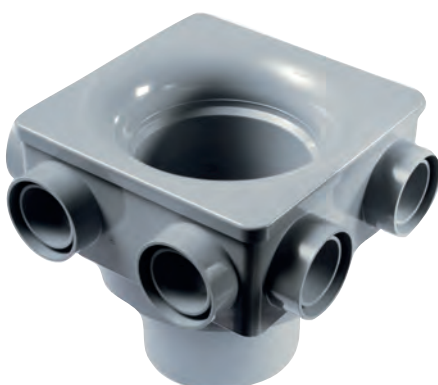

'How to' Videos

To support Osma Soil and Waste there is a set of installation 'how to' videos to show how you can make light work of challenging plumbing problems. They can be viewed at www.youtube.com/WavinUK on the Osma playlist.



Introduction to Wavin Osma Waste

Waste and Overflow Systems

The Wavin Osma range offers both push-fit and solvent weld waste systems. These are supported by V-Joint traps, two overflow systems (push-fit and solvent weld options), condensate drainage and Hep_vO waterless self-sealing waste valves.

Z Wavin OsmaWeld – ABS Solvent Weld Waste

W Wavin Osma – PP Push-fit Waste

The systems fully coordinate with Wavin OsmaSoil systems.

PVC-C Waste can now be found in the Wavin Soil portfolio.



ABS Solvent Weld Waste system

- 32, 40 and 50mm pipes and fittings
- Colour choice: Black, Grey and White
- Manufactured in ABS (Acrylonitrile Butadiene Styrene) to BS EN 1455-1: 2000

Table 5: ABS Solvent Weld Waste system: Pipe Dimensions (mm) and Weights (kg/m)

Nominal Size (mm)	Outside Diameter		Wall Thickness		Average Weight (kg/m)
	Min	Max	Min	Max	
32	36.1	36.5	1.8	2.2	0.23
40	42.7	43.1	1.9	2.3	0.28
50	55.7	56.1	2.0	2.4	0.40

Table 6: ABS Solvent Weld Waste system: Socket Dimensions (mm)

Nominal Size (mm)	Internal Depth	Maximum Outside Diameter
32	20	41
40	24	47
50	32	60



PP Push-fit Waste system

- 32, 40 and 50mm pipes and fittings
- Colour choice: Black, Grey and White (32, 40mm versions) 50mm: Grey and White
- Simple-to-use system: saves time and site costs
- Quick, efficient assembly by means of push-fit jointing
- Manufactured in Polypropylene to BS EN 1451-1:2000

Table 9: PP Push-Fit Waste system: Pipe Dimensions (mm) and Weights (kg/m)

Nominal Size (mm)	DN/OD	Outside Diameter		Wall Thickness		Average Weight (kg/m)
		Min	Max	Min	Max	
32	34	34.4	34.8	1.8	2.2	0.187
40	41	40.8	41.2	1.9	2.3	0.225
50	54	53.9	54.3	2.0	2.4	0.335

Table 10: PP Push-Fit Waste system: Socket Dimensions (mm)

Nominal Size (mm)	DN/OD	Internal Depth (minimum)	Maximum Outside Diameter
32	34	33	49
40	41	34	55
50	54	36	70

*DN/OD as stated in BS EN 1451-1 Standard



V-Joint Traps

- 32, 40 and 50mm diameter domestic traps and accessories
- Colour: White only
- For use with all Wavin Osma waste systems and with copper pipe
- Comprehensive range including tubular, bottle, bath and washing machine traps, and shower gullies
- Manufactured in Polyethylene to BS 3943:1983
- BS EN 1451-1:2000 plastic pipe should be first warmed in hot water before connection is made to the trap

Table 11: V-Joint Traps: Socket Dimensions (mm)

Nominal Size (mm)	Internal Depth	Maximum Outside Diameter
32	39	60
40	40	66
50	49	68



Condensate Drainage

- For installation in association with new and replacement condensing boilers for domestic central heating
- For direct connection to Wavin Osma Drainage Systems via soil stack, rainwater downpipe or external soakaway
- Including traps, connectors, external soakaway and non-return valve
- Compatible with all Wavin Osma Overflow Systems
- Easy installation of all components
- Supports new energy efficiency regulations under Part L



Introduction to Wavin Osma Waste

Solvent Weld Overflow system

- 21.5 Solvent Weld system
- Colour: White only
- Removing overflow water from condensing boilers and cisterns/tanks
- Compatible with Wavin Osma Condensate Fittings
- Allows direct connection to condensing boilers fittings
- Secure permanent jointing
- Manufactured in ABS (fittings) and PVC-U (pipe)



Table 12: ABS and PVC-U Solvent Weld Overflow System: Pipe Dimensions (mm) and Weights (kg/m)

Nominal Size (mm)	Outside Diameter		Wall Thickness		Average Weight (kg/m)
	Min	Max	Min	Max	
21.5	21.5	21.63	1.09	1.27	0.145

Table 13: ABS and PVC-U Solvent Weld Overflow System: Socket Dimensions (mm)

Nominal Size (mm)	Internal Depth	Maximum Outside Diameter
21.5	26	27

PP Push-fit Overflow system

- 21.5mm Push-fit system
- Colour: White only
- Manufactured in Polypropylene



Table 14: PP Push-Fit Overflow System: Pipe Dimensions (mm) and Weights (kg/m)

Nominal Size (mm)	Outside Diameter		Wall Thickness		Average Weight (kg/m)
	Min	Max	Min	Max	
21.5	21.5	21.63	1.09	1.27	0.075

Table 15: Solvent Weld Overflow System: Pipe Dimensions (mm)

Nominal Size (mm)	Internal Depth	Maximum Outside Diameter
21.5	26	26

HepvO Hygienic Self-Sealing Waste Valves

- HepvO is a self-sealing waste valve which prevents foul sewer air from entering a building
- HepvO is suitable for use as an alternative to a traditional water trap. As it doesn't rely on trapped water to create a seal, HepvO cannot lose its seal due to evaporation, movement or siphonage
- With its space saving design, HepvO can be installed horizontally or vertically
- HepvO allows the admittance of air into the waste system and can replace the need for AAV's in branch ventilation
- 32 and 40mm fittings: HepvO valves, knuckle adaptors, running adaptors and tundish kit (32mm only)
- Manufactured in white polypropylene
- For installation information, please refer to the HepvO Product and Installation Manual (SW102)

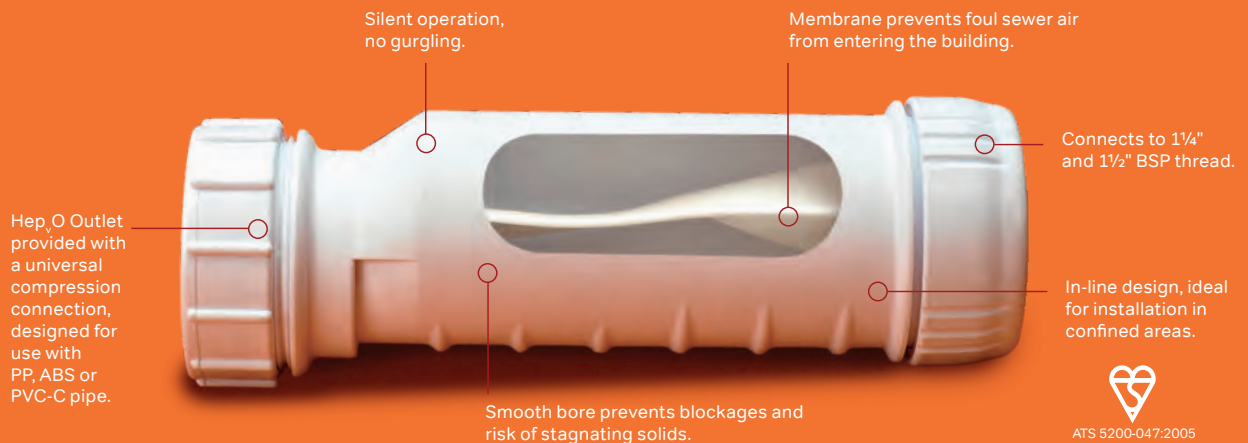

System selector

Wavin Osma Soil and Waste

Soil and Waste profiles – Key fittings

		Colour	Pipe	21.5 mm	32 mm	40 mm	50 mm	82 mm	110 mm	160 mm	Brackets	Pipe	Clip	Socket	Pipe or Socket	Suspended	Sockets	Push-Fit	Solvent Weld	Push-Fit/SW
Osma Soil Systems	PVC-U Ring-Seal Soil	●●○		-	-	-	-	■	■	■		■	-	■	■	■		■	■	■
	PVC-U Solvent Weld Soil	●●○		-	-	-	-	-	■	■		■	-	■	■	■		-	■	■
Osma Waste Systems	ABS Solvent Weld Waste	●●○		-	■	■	■	-	-	-		■	■	-	-	-		-	■	■
	PP Push-Fit Waste	●●○		-	■	■	■	-	-	-		■	-	-	-	-		■	-	-
	Condensate Drainage	○		■	-	-	-	-	-	-		-	-	-	-	-		■	-	-
	Hep _v O	○		-	■	■	-	-	-	-		-	-	-	-	-		-	-	-
Osma Overflow Systems	PVC-U Solvent Weld	○		■	-	-	-	-	-	-		-	■	-	-	-		-	■	-
	PP Push-Fit	○		■	-	-	-	-	-	-		-	■	-	-	-		■	-	-

Other fittings

OsmaLink Soil Manifold 4S495 and 6-Boss Soil Manifold 4S597

For use with waste pipes

Manifold Branches

For connection of up to 8 WCs

- Straight – 8°
- 15½° – 23°
- 30½° – 38°

WC Connectors

For use with Push-Fit and Solvent Weld Soil systems:

Connectors (for BS 5503 WCs)

- 2½° – 14°
- 90° – 90° (Access)

Connectors (for BS 1213 WCs)

- Straight – 87½°

Easy-Fit Pan Connectors (for BS 1213 WCs)

- Straight – Offset
- 14° – 90°

Vents

- Air Admittance Valves (110mm and 40mm)
- Terminal Fittings
- Pipe Flashings (pitched and flat roof)
- Roof Outlets

Traps

For use with all Wavin Osma Waste systems.

Trap types:

- Bottle – Tubular
- Bath – Shower
- Washing Machine

Fire Stop Seals

For 50, 82, 110 and 160mm pipework

Connectors (See KEY)*	Reducers (See KEY)*	Bends	90°	87½°	76°	67½°	45°	30°	15°	11¼°	Offset	Adjust.		Branches	Single		Double			Corner	Access	Pipe	Bend	Branch	Bossed Pipe
												90°	30°		Equal/Tee	Unequal	Equal/Cross	Unequal	45°						
abc	tuvw	-	■	■	■	■	■	■	■	-	■	■	■		■	■	■	■	■	■		■	■	■	■
ab	uvw	-	■	-	■	■	-	■	■	■	-	-		■	■	■	-	-	■		■	■	■	■	
def ghj	mnp qrs	■	■	-	-	■	-	-	-	-	-	-		■	-	■	-	-	-		-	-	-	-	
ghj	mnp	■	■	-	-	■	-	-	-	-	-	-		■	-	-	-	-	-		-	-	-	-	
-	-	-	-	-	-	-	-	-	-	-	-	-		-	-	-	-	-	-		-	-	-	-	
-	-	-	-	-	-	-	-	-	-	-	-	-		-	-	-	-	-	-		-	-	-	-	
dx	-	■	-	-	-	■	-	-	-	-	-	-		-	-	-	-	-	-		-	-	-	-	
x	-	■	-	-	-	■	-	-	-	-	-	-		-	-	-	-	-	-		-	-	-	-	

*Key

Connectors

- a Connector to Cast-Iron Socket
- b Connector to Cast-Iron Spigot
- c Connector to Cast-Iron or Clay Drain Socket
- d Straight Tank Connector
- e Universal Connector
- f Male Iron Connector
- g Female Iron Connector
- h Connector to BS 659 Copper Spigot – Compression Joint
- j Connector to BS 659 Copper Compression Fitting
- k Universal Compression Connector

Reducers

- m Reducer 40 to 32mm
- n Reducer 50 to 32mm
- p Reducer 50 to 40mm
- q Reducer to 19mm Overflow
- r Reducer to 35mm copper pipe
- s Reducer to 42mm copper pipe
- t Reducer 82 to 50mm
- u Reducer 110 to 50mm
- v Reducer 110 to 82mm
- w Reducer 160 to 110mm
- x Bent Tank Connector

Colour key

Colour	Ref. Code
Black	●
Grey	●
White	○

***NOTE: Guide only.**

Some connectors not available in more than one size. Some waste connectors and reducers listed are available in two versions. Check listings to ensure availability of suitable fitting.

Estimating Data

Wavin Osma Soil and Waste

Estimating data

The following data is provided to help estimation of quantities required for pipe support and jointing.

Pipe Support

Pipes should be supported at the maximum centres shown opposite in Table 16.

Offset Bends

Pipe Brackets should also be fitted around the Offset Bend or directly below.

Table 16: Maximum Pipe Support Centres

Pipe Size (mm)	Centres (m)	
	Vertical	Horizontal
21.5	0.5	0.5
32	1.2	0.5
40	1.2	0.5
50	1.2	0.6
82	2	1
110	2	1
160	2	1.2

Jointing material allowances

Lubricant Allowance

For push-fit ring-seal joints (approximate figures).

Table 17: Lubricant Usage Guide

Description	Part No.	Nominal Pipe Sizes (mm) No. of Joints					
		32	40	50	82	110	160
Silicone Lubricant 50g tube	4S391	44	37	20	16	9	4

Degreasing Cleaner/Solvent Cement Allowances

For solvent weld joints (approximate figures).

Table 18: Cleaner/Solvent Cement Usage Guide

Description	Part No.	Nominal Pipe Sizes (mm) No. of Joints						
		21.5	32	40	50	82	110	160
Degreasing Cleaner No.1 125ml can	4S379	120	70	45	33	25	16	10
Degreasing Cleaner No.1 250ml can	4S380	240	140	90	66	50	32	20
Solvent Cement No.2 125ml can	4S383	90	45	30	20	8	5	3
Solvent Cement No.2 250ml can	4S384	180	90	60	40	16	11	6
Solvent Cement No.2 500ml can	4S385	360	180	120	80	32	22	12

Product Details

Wavin OsmaSoil – PVC-U Ring-seal system

Key			
P/E:	Pipe and fittings with both ends plain or with one plain end and one special end	S/SW:	Fittings with one or more ring-seal sockets but always one solvent socket
S/S:	Pipe and fittings with one or more ring-seal or push-fit sockets, but always one plain or special end	SW/S:	Fittings with one or more solvent sockets and one plain or special end
D/S:	Fittings with ring-seal or push-fit sockets at all ends	D/SW:	Fittings with solvent sockets at all ends

Pipe



Socketed Pipe

- One plain end, one ring-seal socket
- 110 /160mm sizes are made with Wavin Recycore technology – a multi-layer construction with over 50% recycled material in solid core
- 110 /160 mm pipe sizes are BS EN 1453-1:2000 kitemarked but have exactly the same performance characteristics as BS EN 1329-1:2000
- 82mm pipe is standard PVC-U pipe, kitemarked to BS EN 1329-1

Material: PVC-U, with Rubber seals



Nominal Size (mm)	Part Number	Colour Option	Length (m)	Dimensions (mm) A	Dimensions (mm) (O/D) B
82	3S043 ♡	● ●	3	51	104
110	4S042 ♡ △	● ● ●	2	65	132
110	4S050 ♡ △	● ●	2.5	65	132
110	4S043 ♡ △	● ● ● ○	3	65	132
110	4S044 ♡ △	● ● ● ○	4	65	132
160	6S043 ♡ △	● ●	3	88	191
160	6S044 ♡ △	● ●	4	88	191



Plain-Ended Pipe

- 110 /160mm sizes are made with Wavin Recycore technology – a multi-layer construction with over 50% recycled material in solid core
- 110 /160 mm pipe sizes are BS EN 1453-1:2000 kitemarked but have exactly the same performance characteristics as BS EN 1329-1:2000
- 82mm pipe is standard PVC-U pipe, kitemarked to BS EN 1329-1

Material: PVC-U



Nominal Size (mm)	Part Number	Colour Option	Length (m)
82	3S074 ♡	● ●	4
110	4S073 ♡ △	● ● ● ○	3
110	4S074 ♡ △	● ● ● ○	4
160	6S074 ♡ △	● ● ●	4

Product Details

Wavin OsmaSoil – PVC-U Ring-seal system

Brackets

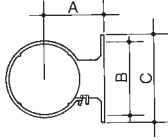

Pipe Bracket

- For support centres, see pages 10, 88 and 107

Material: PVC-U

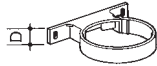

Nominal Size (mm)	Part Number	Colour Option	Dimensions (mm)				Fixing Hole
			A	B	C	D	
82	3S082 ▽	● ●	76	92	112	16	6.5 dia
110	4S082 ▽	● ● ○	94	120	140	25	6.5 dia
160	6S082 ▽	● ●	123	175	200	32	8 dia

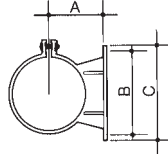

Socket Bracket

- Position in the recessed area adjacent to the sealing-ring housing
- For support centres, see pages 10, 88 and 107

Material: PVC-U

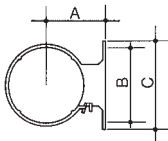
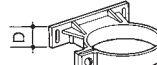

Nominal Size (mm)	Part Number	Colour Option	Dimensions (mm)				Fixing Hole
			A	B	C	D	
82	3S083 ▽	● ●	76	78	140	28.5	6.5 dia
110	4S083 ▽	● ● ○	94	120	140	25	6.5 dia

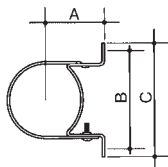

Pipe or Socket Bracket

- Multi-functional support component that can be used for pipes or sockets
- When using as a socket bracket, always position unit in the recessed area adjacent to the sealing-ring housing
- For support centres, see pages 10, 88 and 107

Material: BZP – Coated Mild Steel



Nominal Size (mm)	Part Number	Dimensions (mm)				Fixing Hole
		A	B	C	D	
110	4S084 ▽	94	160	180	20	7 dia
160	6S084 ▽	124	220	240	25	7 dia

Suspended Bracketing System



Adjustable Pipe Bracket Assembly

- Pack contains Threaded Rod, Threaded Bracket, Bracket Plate and Pipe/Socket Bracket
- For support centres, see pages 10, 88 and 107
- Not suitable for damp inaccessible voids

Material: BZP – Coated Mild Steel

Nominal Size (mm)	Part Number
110	4S086
160	6S086



Adjustable Socket Bracket and Brace Assembly

- Pack contains Threaded Rod, Threaded Bracket, Bracket Plate, two Adjustable Braces, and Pipe/Socket Bracket
- For support centres, see pages 10, 88 and 107
- Not suitable for damp inaccessible voids

Material: BZP – Coated Mild Steel

Nominal Size (mm)	Part Number
110	4S085

Suspended Bracketing System – Components

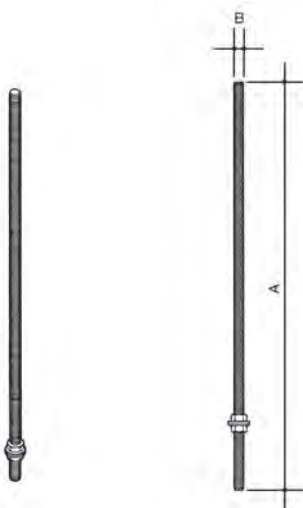

M8 Threaded Rod

Material: BZP – Coated Mild Steel

Nominal Size (mm)	Part Number	Dimensions (mm)	
		A	B
–	–	500	8

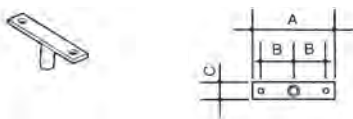

Threaded Bracket

Material: BZP – Coated Mild Steel

Nominal Size (mm)	Part Number	Dimensions (mm)		
		A	B	C
–	–	120	40	30

Product Details

Wavin OsmaSoil – PVC-U Ring-seal system

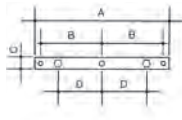

Bracket Plate

Material: BZP – Coated Mild Steel

Nominal Size (mm)	Part Number	Dimensions (mm)			
		A	B	C	D
–	–	240	110	20	80

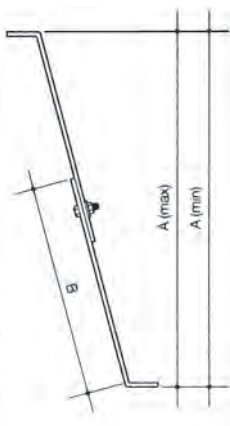

Adjustable Brace

- Used for creating anchor points

Material: BZP – Coated Mild Steel

Nominal Size (mm)	Part Number	Dimensions (mm)		
		A min	A max	B
–	–	264	493	260

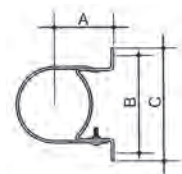

Pipe or Socket Bracket

Material: BZP – Coated Mild Steel

Nominal Size (mm)	Part Number	Dimensions (mm)				Fixing Hole
		A	B	C	D	
110	–	94	160	180	20	7 dia
160	–	124	220	240	25	7 dia

Sockets



D/SW Double Socket

- Solvent weld socket at each end

Material: PVC-U

Nominal Size (mm)	Part Number	Colour Option	Dimensions (mm)	
			A	B
110	4S104	● ● ○	98	2
160	6S104	● ●	119	3

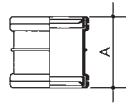

D/S Double Socket – for repairs

- Push-fit ring-seal socket at each end
- Used as a slip coupler for making repairs

Material: PVC-U, with Rubber seals

Nominal Size (mm)	Part Number	Colour Option	Dimensions (mm)
			A
82	3S105	● ●	102
110	4S105	● ● ○	111
160	6S105	●	145

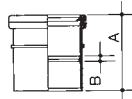

S/SW Single Socket

- One solvent weld socket and one push-fit ring-seal socket
- Used for creating a fixed ring-seal joint on a plain-ended pipe or fitting, or where an expansion joint is required to accommodate thermal movement

Material: PVC-U, with Rubber seals

Nominal Size (mm)	Part Number	Colour Option	Dimensions (mm)	
			A	B
82	3S124	● ●	97	2
110	4S124	● ● ○	105	2
160	6S124	● ●	135	2



Acoustic Socket

- Push-fit ring-seal socket at each end
- For acoustic performance and built in allowance for thermal expansion
- Can be used as an alternative to 4S124 (see pages 104-105 for full product details)

Material: PVC-U, with Rubber seals

Nominal Size (mm)	Part Number	Colour Option	Dimensions (mm)
			A
110	4S125	● ●	133

For installation tips see:



Product Details

Wavin OsmaSoil – PVC-U Ring-seal system

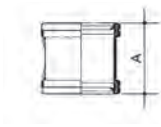

D/S Double Socket

- Push-fit ring-seal socket at each end

Material: PVC-U, with Rubber seals

Nominal Size (mm)	Part Number	Colour Option	Dimensions (mm)	
			A	B
110	4S205	● ● ○	115	

Connectors

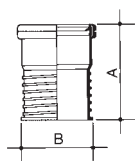

S/S Connector to Cast-Iron Soil Socket

- Connector to BS 416 cast-iron soil socket

Material: PVC-U, with Rubber seals

Nominal Size (mm)	Part Number	Colour Option	Dimensions (mm)	
			A	B
110	4S106	●	162	123



Connector to Cast-Iron Socket

- Connector to BS 416 cast-iron soil socket

Material: Neoprene Synthetic Rubber

Nominal Size (mm)	Part Number	Colour Option	Dimensions (mm)
			A
110	4S206	●	66



Internal Drain Connector

- For 32mm/40mm waste pipe and 50mm waste pipe

Material: Neoprene Synthetic Rubber

Nominal Size (mm)	Part Number	Dimensions (mm)
		A
110x32/40	4S298	60.5
110x50	4S299	60.5

Reducers

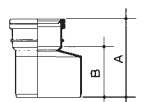

S/S Reducer

Material: PVC-U, with Rubber seals

Nominal Size (mm)	Part Number	Colour Option	Dimensions (mm)	
			A	B
82x50	3S094	● ●	119	68

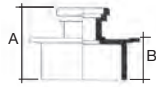

Reducer

Material: PVC-U, with Rubber seals

Nominal Size (mm)	Part Number	Colour Option	Dimensions (mm)	
			A	B
110x32	4S098	●	85	57
110x40	4S097	●	85	57

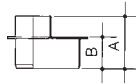

S/S Reducer

Material: PVC-U, with Rubber seals

Nominal Size (mm)	Part Number	Colour Option	Dimensions (mm)	
			A	B
110x50	4S096	● ●	103	53

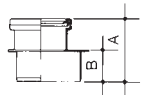

S/S Reducer

Material: PVC-U, with Rubber seals

Nominal Size (mm)	Part Number	Colour Option	Dimensions (mm)	
			A	B
110x82	4S095	● ●	103	53

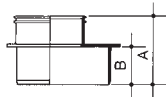

S/S Reducer

Material: PVC-U, with Rubber seals

Nominal Size (mm)	Part Number	Colour Option	Dimensions (mm)	
			A	B
160x110	6S099	●	130	68

Product Details

Wavin OsmaSoil – PVC-U Ring-seal system

Bends

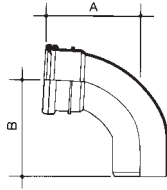

S/S Bend – 87.5°

- One plain end and one push-fit ring-seal socket

Material: PVC-U, with Rubber seals

Nominal Size (mm)	Part Number	Colour Option	Dimensions (mm)	
			A	B
82	3S161 ▾	● ●	128	125
110	4S161 ▾	● ● ○	162	160
160	6S161 ▾	●	240	247

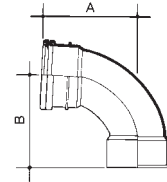

S/SW Bend – 87.5°

- One solvent weld socket and one push-fit ring-seal socket

Material: PVC-U, with Rubber seals

Nominal Size (mm)	Part Number	Colour Option	Dimensions (mm)	
			A	B
110	4S361 ▾	●	160	160

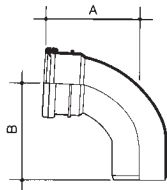

S/S Tight Radius Bend – 87.5°

- One plain end and one push-fit ring-seal socket

Material: PVC-U, with Rubber seals

Nominal Size (mm)	Part Number	Colour Option	Dimensions (mm)	
			A	B
110	4S160 ▾	● ● ○	132	110

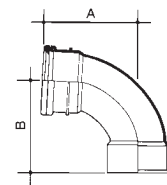

D/S Bend – 87.5°

- Push-fit ring-seal socket at each end

Material: PVC-U, with Rubber seals

Nominal Size (mm)	Part Number	Colour Option	Dimensions (mm)	
			A	B
110	4S561 ▾	● ● ○	175	160

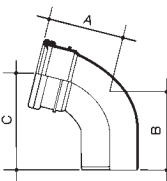

S/S Bend – 76°

- One plain end and one push-fit ring-seal socket

Material: PVC-U, with Rubber seals

Nominal Size (mm)	Part Number	Colour Option	Dimensions (mm)		
			A	B	C
110	4S164 ▾	● ●	146	148	180

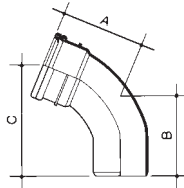

S/S Bend – 67.5°

- One plain end and one push-fit ring-seal socket

Material: PVC-U, with Rubber seals

Nominal Size (mm)	Part Number	Colour Option	Dimensions (mm)		
			A	B	C
110	4S162 ♡	●	155	154	212

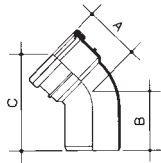

S/S Bend – 45°

- One plain end and one push-fit ring-seal socket

Material: PVC-U, with Rubber seals

Nominal Size (mm)	Part Number	Colour Option	Dimensions (mm)		
			A	B	C
82	3S163 ♡	● ●	81	70	126
110	4S163 ♡	● ● ○	83	87	145
160	6S163 ♡	●	140	118	215

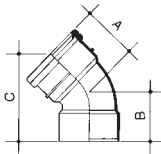

S/SW Bend – 45°

- One solvent weld socket and one push-fit ring-seal socket

Material: PVC-U, with Rubber seals

Nominal Size (mm)	Part Number	Colour Option	Dimensions (mm)		
			A	B	C
110	4S363 ♡	● ● ○	98	86	155

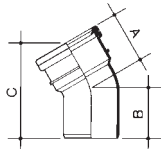

S/S Bend – 30°

- One plain end and one push-fit ring-seal socket

Material: PVC-U, with Rubber seals

Nominal Size (mm)	Part Number	Colour Option	Dimensions (mm)		
			A	B	C
110	4S166 ♡	●	92	95	162

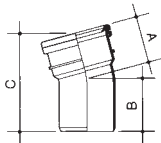

S/S Bend – 15°

- One plain end and one push-fit ring-seal socket

Material: PVC-U, with Rubber seals

Nominal Size (mm)	Part Number	Colour Option	Dimensions (mm)		
			A	B	C
110	4S167 ♡	●	85	76	157

Product Details

Wavin OsmaSoil – PVC-U Ring-seal system

Adjustable Bends

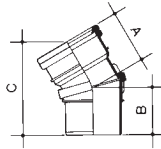

Adjustable Bend – 30°

- One plain end and one push-fit ring-seal socket
- Variable angle up to 30°
- Rotate segments to achieve required change of direction (flow arrow on socket indicates orientation of fitting)
- BBA certificated (Certificate No. 89/2174)

Material: Polypropylene, with Rubber seals

Nominal Size (mm)	Part Number	Colour Option	Dimensions (mm)		
			A	B	C
110	4S173 ▲	●	97	90	180

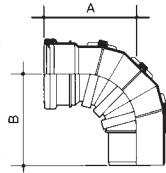

Adjustable Bend – 90°

- One plain end and one push-fit ring-seal socket
- Variable angle up to 90°
- Can accommodate up to 60mm centre-line to centre-line misalignment of pipework
- Rotate segments to achieve required change of direction (flow arrow on socket indicates orientation of fitting)
- BBA certificated (Certificate No. 89/2174)

Material: Polypropylene, with Rubber seals

Nominal Size (mm)	Part Number	Colour Option	Dimensions (mm)	
			A	B
110	4S179 ▲	●	167	165

Offset Bends

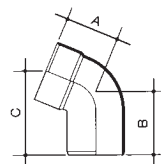

SW/S Offset Bend (bottom) – 67.5°

- One plain end and one solvent weld socket
- Minimum achievable offsets: 82 – 115mm, 110 – 137mm

Material: PVC-U

Nominal Size (mm)	Part Number	Colour Option	Dimensions (mm)		
			A	B	C
82	3S435 ▼	●	92	87	123
110	4S435 ▼	● ● ○	99	105	143

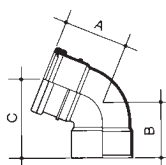

S/SW Offset Bend (top) – 67.5°

- One solvent weld socket and one push-fit ring-seal socket
- Minimum achievable offsets: 82-115mm, 110-137mm, 160-233mm

Material: PVC-U, with Rubber seals

Nominal Size (mm)	Part Number	Colour Option	Dimensions (mm)		
			A	B	C
82	3S440 ▼	● ●	95	87	123
110	4S440 ▼	● ● ○	110	99	140
160	6S440 ▼	●	177	160	225

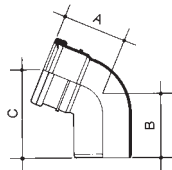

S/S Offset Bend – 67.5°

- One plain end and one push-fit ring-seal socket
- Minimum achievable offset: 110-137mm

Material: PVC-U, with Rubber seals

Nominal Size (mm)	Part Number	Colour Option	Dimensions (mm)		
			A	B	C
110	4S444	● ● ○	110	105	147

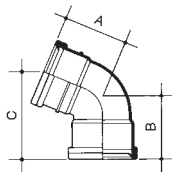

D/S Offset Bend – 67.5°

- Fitted with two push-fit ring-seal sockets
- Minimum achievable offset: 137mm

Material: PVC-U, with Rubber seals

Nominal Size (mm)	Part Number	Colour Option	Dimensions (mm)		
			A	B	C
110	4S445	● ● ○	110	110	155

Manifolds

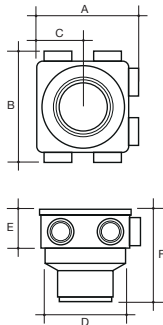
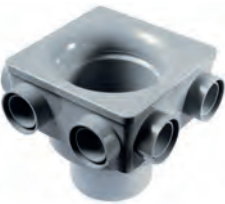

6 Boss Manifold

- One plain end and one solvent weld socket
- 6 boss connection points (No boss adaptors required)
- Dual 40/50mm solvent weld connection
- Compact design, 163mm body sits easily into 200mm drilled or formed hole
- Branch low in fitting: 132mm from centreline of branch horizontal inlet to 50mm spigot invert
- Horizontal waste connection: instead of vertical connection – no upstanding bends required

Material: PVC-U

Nominal Size (mm)	Part Number	Colour Option	Dimensions (mm)					
			A	B	C	D	E	F
110	4S597	●	204	222	94	163	79	184

For installation tips see:

YouTube
WavinUK

Product Details

Wavin OsmaSoil – PVC-U Ring-seal system

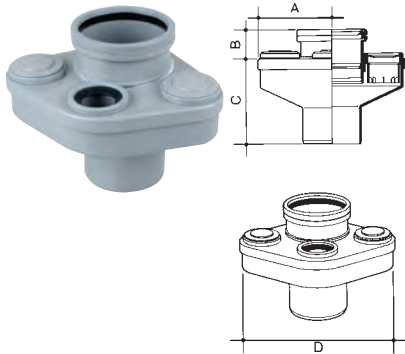

OsmaLink Soil Manifold

- One plain end and one push-fit ring-seal socket
- Permits up to three 50mm connections to be made at floor level
- Complies with BS EN 12056-2:2000 clause ND. 3.3.2
- Make connections using 4Z124, 2S355 or 2S356
- Minimum installation aperture: 240mm square

Material: PVC-U, with Rubber seals

Nominal Size (mm)	Part Number	Colour Option	Dimensions (mm)			
			A	B	C	D
110	4S595	●	138	55	160	275



All-Fit Reducer – 40:32mm

- Connects to 32mm plastic pipe to BS EN 1451-1/BS EN 1455-1/ BS EN 1566-1, or to copper pipe manufactured to BS 659 or BS 2871
- Use with 2S355 (below) when a bend is required

Material: Polypropylene

Nominal Size (mm)	Part Number	Colour Option	Dimensions (mm)
			A
40	4Z124	○	54



All-Fit Reduction Bend – 50:40mm

- Connects to 40mm plastic pipe to BS EN 1451-1/BS EN 1455-1/ BS EN 1566-1, or to copper pipe manufactured to BS 659 or BS 2871

Material: Polypropylene

Nominal Size (mm)	Part Number	Colour Option	Dimensions (mm)	
			A	B
50	2S355	○	70	65



All-Fit 90° Spigot Bend – 50mm

- Connects to 50mm plastic pipe to BS EN 1451-1/BS EN 1455-1/ BS EN 1566-1, or to copper pipe manufactured to BS 659 or BS 2871

Material: ABS

Nominal Size (mm)	Part Number	Colour Option	Dimensions (mm)	
			A	B
50	2S356	○	79	64

Single Branches

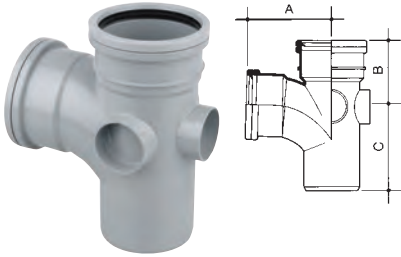

S/S Single Branch – 87.5°

- One plain end and two push-fit ring-seal sockets
- With closed boss socket positions: two on 82mm and 160mm fittings, three on 110mm fitting

Material: PVC-U, with Rubber seals

Nominal Size (mm)	Part Number	Colour Option	Dimensions (mm)		
			A	B	C
82	3S190 ▽	● ●	155	118	146
110	4S190 ▽	● ● ○	150	120	142
160	6S190 ▽	●	230	170	230

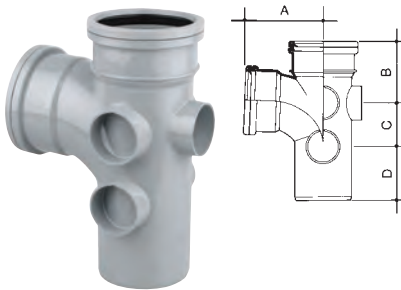

S/S Single 5-Boss Branch – 87.5°

- One plain end and two push-fit ring-seal sockets
- Five closed boss sockets, of which two are positioned 84mm below the centre-line of the branch entry. These can be used for low-level waste connections (as alternative to Soil Manifold 4S595)

Material: PVC-U, with Rubber seals

Nominal Size (mm)	Part Number	Colour Option	Dimensions (mm)			
			A	B	C	D
110	4S195 ▽	● ● ○	150	118	84	101

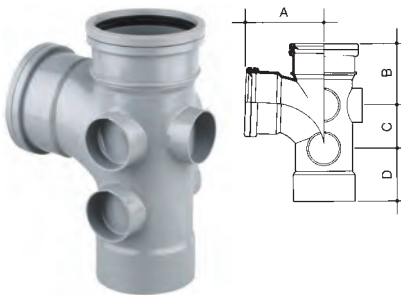

S/SW Single 5-Boss Branch – 87.5°

- One solvent weld socket and two push-fit ring-seal sockets
- Five closed boss sockets, of which two are positioned 84mm below the centre-line of the branch entry. These can be used for low-level waste connections (as alternative to Soil Manifold 4S595)

Material: PVC-U, with Rubber seals

Nominal Size (mm)	Part Number	Colour Option	Dimensions (mm)			
			A	B	C	D
110	4S395 ▽	●	150	118	84	98

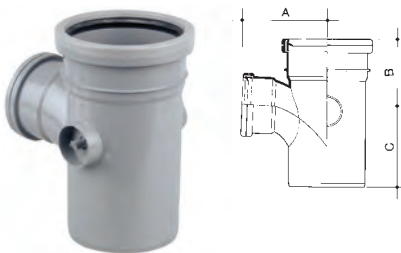

S/S Unequal Single Branch – 87.5°

- One 160mm plain end/push-fit ring-seal socket, and one 110mm push-fit ring-seal socket on the branch
- Two closed boss socket positions

Material: PVC-U, with Rubber seals

Nominal Size (mm)	Part Number	Colour Option	Dimensions (mm)		
			A	B	C
160	6S198 ▽	●	176	148	155

Product Details

Wavin OsmaSoil – PVC-U Ring-seal system

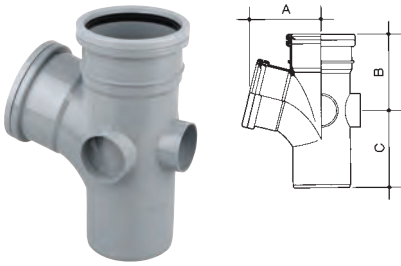

S/S Single Branch – 76°

- One plain end and two push-fit ring-seal sockets
- Three closed boss socket positions

Material: PVC-U, with Rubber seals

Nominal Size (mm)	Part Number	Colour Option	Dimensions (mm)		
			A	B	C
110	4S220	● ●	161	159	155

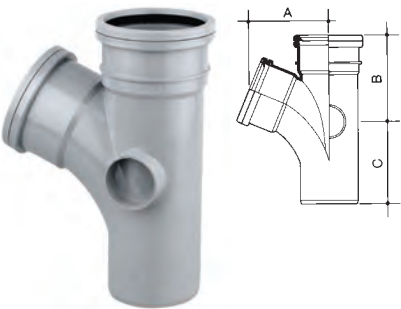

S/S Single Branch – 67.5°

- One plain end and two push-fit ring-seal sockets
- 110mm fitting has two closed boss socket positions.
- 82mm fitting does not have side bosses

Material: PVC-U, with Rubber seals

Nominal Size (mm)	Part Number	Colour Option	Dimensions (mm)		
			A	B	C
110	4S200	● ●	150	159	155

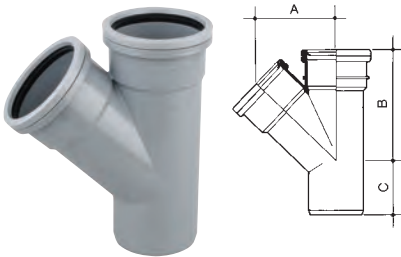

S/S Single Branch – 45°

- One plain end and two push-fit ring-seal sockets

Material: PVC-U, with Rubber seals

Nominal Size (mm)	Part Number	Colour Option	Dimensions (mm)		
			A	B	C
82	3S210	●	115	157	70
110	4S210	● ●	141	198	89
160x110	6S218	●	183	301	137
160x160	6S210	●	204	288	125

Double Branches

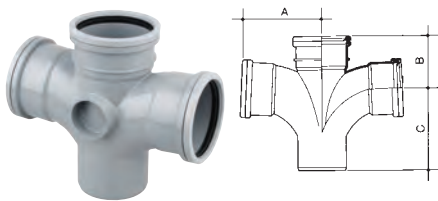

S/S Double Branch – 87.5°

- One plain end and three push-fit ring-seal sockets
- Two closed boss socket positions

Material: PVC-U, with Rubber seals

Nominal Size (mm)	Part Number	Colour Option	Dimensions (mm)		
			A	B	C
110	4S230	● ● ○	146	115	149

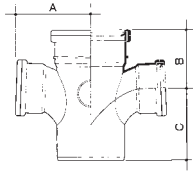

S/S Unequal Double Branch – 87.5°

- One 160mm plain end/push-fit ring-seal socket, and two 110mm push-fit ring-seal sockets on the branch
- Two closed boss socket positions

Material: PVC-U, with Rubber seals

Nominal Size (mm)	Part Number	Colour Option	Dimensions (mm)		
			A	B	C
160	6S238 ♡	●	176	138	164

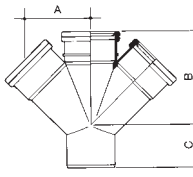

S/S Double Branch – 45°

- One plain end and three push-fit ring-seal sockets

Material: PVC-U, with Rubber seals

Nominal Size (mm)	Part Number	Colour Option	Dimensions (mm)		
			A	B	C
110	4S250 ♡	●	147	212	99

Corner Branch

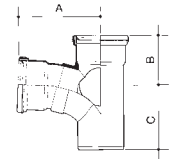

S/S Corner Branch – 87.5°

- One plain end and three push-fit ring-seal sockets
- One closed boss socket position

Material: PVC-U, with Rubber seals

Nominal Size (mm)	Part Number	Colour Option	Dimensions (mm)		
			A	B	C
110	4S291 ♡	●	190	125	144

Boss Socket Adaptors

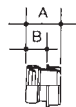

S/S Ring-Seal Boss Adaptor

- Suitable for all OsmaSoil fittings with boss socket positions
- Connects to 32mm [1¼"], 40mm [1½"] or 50mm [2"] plastic pipe to BS EN 1451-1/BS EN 1455-1/BS EN 1566-1, or to copper pipe manufactured to BS 659 or BS 2871
- Horizontal adaptors have an inbuilt 2.5° fall

Material: PVC-U

Nominal Size (mm)	Part Number	Colour Option	Dimensions (mm)	
			A	B
32	2S398 ♡	● ● ○	50	27
40	2S399 ♡	● ● ○	53	30

Product Details

Wavin OsmaSoil – PVC-U Ring-seal system

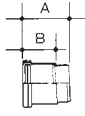

S/S Ring-Seal Boss Adaptor

- Suitable for all OsmaSoil fittings with boss socket positions
- Connects to 32mm [1¼"], 40mm [1½"] or 50mm [2"] plastic pipe to BS EN 1451-1/BS EN 1455-1/BS EN 1566-1, or to copper pipe manufactured to BS 659 or BS 2871
- Horizontal adaptors have an inbuilt 2.5° fall

Material: PVC-U

Nominal Size (mm)	Part Number	Colour Option	Dimensions (mm)	
			A	B
50	2S402 ♡	● ● ○	70	52

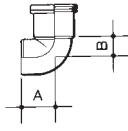

S/S Ring-Seal Boss Adaptor – 90°

- Suitable for all OsmaSoil fittings with boss socket positions
- Connects to 50mm [2"] plastic pipe to BS EN 1455-1/BS EN 1566-1 or use with Long Tail Bend 2Z359

Material: ABS

Nominal Size (mm)	Part Number	Colour Option	Dimensions (mm)	
			A	B
50	2S360 ♡	●	50	31

Bossed Pipes

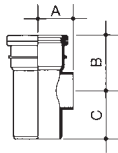

S/S Bossed Pipe

- One plain end and one push-fit ring-seal socket
- One open boss socket position

Material: PVC-U, with Rubber seals

Nominal Size (mm)	Part Number	Colour Option	Dimensions (mm)		
			A	B	C
82	3S649 ♡	● ●	61	90	86

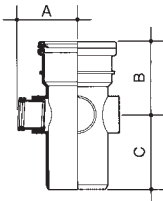

S/S Bossed Pipe

- Connects to 32mm [1¼"] or 40mm [1½"] plastic pipe to BS EN 1451-1/BS EN 1455-1/BS EN 1566-1, or to copper pipe manufactured to BS 659 or BS 2871
- One plain end and one push-fit ring-seal socket
- Three closed boss socket positions and one open, fitted with Adaptor 2S398 or 2S399 (page 25)

Material: PVC-U, with Rubber seals

Nominal Size (mm)	Part Number	Colour Option	Dimensions (mm)		
			A	B	C
110x32	4S581 ♡	● ●	106	114	100
110x40	4S582 ♡	● ●	110	114	100

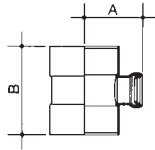

D/SW Ring-Seal Bossed Pipe

- Connects to 32mm [1¼"] or 40mm [1½"] plastic pipe to BS EN 1451-1/BS EN 1455-1/BS EN 1566-1, or to copper pipe manufactured to BS 659 or BS 2871
- Two solvent weld sockets
- One push-fit socket position

Material: PVC-U, with Rubber seals

Nominal Size (mm)	Part Number	Colour Option	Dimensions (mm)	
			A	B
110x32	4S583 ♡	● ● ○	96	150
110x40	4S584 ♡	● ● ○	96	150

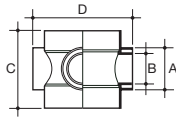

D/SW Short Bossed Pipe

- Three closed boss socket positions for use with the appropriate Boss Socket Adaptor (pages 25-26)
- Three closed 40mm [1½"] spigot tail positions also allow for direct connection of 40mm [1½"] solvent weld sockets

Material: PVC-U

Nominal Size (mm)	Part Number	Colour Option	Dimensions (mm)			
			A	B	C	D
110	4S588 ♡	● ● ○	56	43	124	74

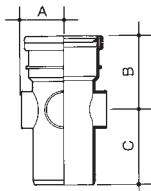

S/S Bossed Pipe

- One plain end and one push-fit ring-seal socket
- Three closed boss socket positions and one open to receive appropriate Boss Socket Adaptor (pages 25-26)

Material: PVC-U, with Rubber seals

Nominal Size (mm)	Part Number	Colour Option	Dimensions (mm)		
			A	B	C
110	4S589 ♡	● ● ○	74	110	108

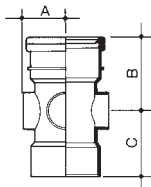

S/SW Bossed Pipe

- One plain end and one push-fit ring-seal socket
- Three closed boss socket positions and one open to receive appropriate Boss Socket Adaptor (pages 25-26)

Material: PVC-U, with Rubber seals

Nominal Size (mm)	Part Number	Colour Option	Dimensions (mm)		
			A	B	C
110	4S590 ♡	● ● ○	74	111	98

Product Details

Wavin OsmaSoil – PVC-U Ring-seal system

Strap Bosses

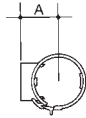

Strap Boss

- For making side connections on BS EN 1329 and BS EN 1453 plastic pipe after construction
- Use with required Boss Socket Adaptor (pages 25-26)

Material: PVC-U

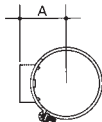

Nominal Size (mm)	Part Number	Colour Option	Dimensions (mm)	
			A	
82	3S319 ♡	● ● ○	63	
110	4S319 ♡	● ● ○	77	



Clip Boss

- For Push-fit or Solvent Waste

Material: PVC-U

Nominal Size (mm)	Part Number	Colour Option	Dimensions (mm)	
			A	B
110x32	4S322 ♡	● ● ○	47	117
110x40	4S321 ♡	● ● ○	47	117



Patch Boss

- For Push-fit or Solvent Waste

Material: PVC-U

Nominal Size (mm)	Part Number	Colour Option	Dimensions (mm)	
			A	B
160x50	6S323 ♡	●	52	101

Access Fittings

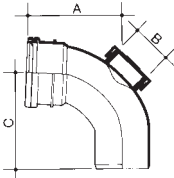

S/S Access Bend – 87.5°

- One plain end and one push-fit ring-seal socket
- Fitted with screwed access cover

Material: PVC-U, with Rubber seals

Nominal Size (mm)	Part Number	Colour Option	Dimensions (mm)		
			A	B	C
110	4S169 ♡	● ● ○	163	80	170

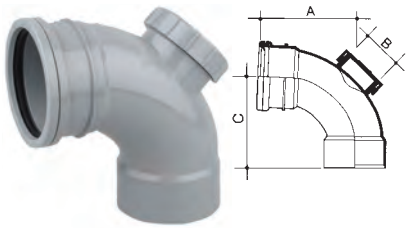

S/SW Access Bend – 87.5°

- One solvent weld socket and one push-fit ring-seal socket
- Fitted with screwed access cover

Material: PVC-U, with Rubber seals

Nominal Size (mm)	Part Number	Colour Option	Dimensions (mm)		
			A	B	C
110	4S369 ♡	●	163	80	160

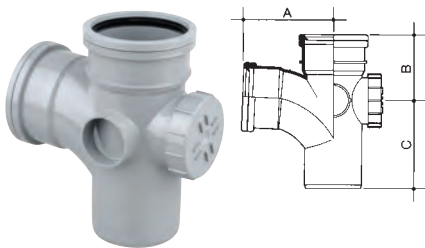

S/S Access Branch – 87.5°

- One plain end and two push-fit ring-seal sockets
- Two closed socket boss positions
- Fitted with screwed access cover

Material: PVC-U, with Rubber seals

Nominal Size (mm)	Part Number	Colour Option	Dimensions (mm)		
			A	B	C
110	4S502 ♡	● ●	150	120	142



S/S Access Pipe

- One plain end and one push-fit ring-seal socket
- Fitted with bolted, oval access door

Material: PVC-U, with Rubber seals

Nominal Size (mm)	Part Number	Colour Option	Dimensions (mm)
			A
82	3S274 ♡	● ●	255

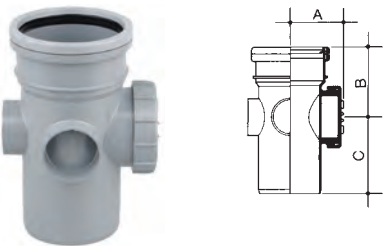

S/S Bossed Access Pipe

- One plain end and one push-fit ring-seal socket
- Three closed socket boss positions
- Fitted with screwed access cover

Material: PVC-U, with Rubber seals

Nominal Size (mm)	Part Number	Colour Option	Dimensions (mm)		
			A	B	C
110	4S274 ♡	● ● ○	95	118	118
160	6S274 ♡	●	130	155	150

Product Details

Wavin OsmaSoil – PVC-U Ring-seal system

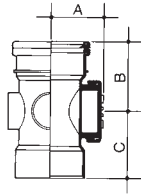

S/SW Bossed Access Pipe

- One solvent weld socket and one push-fit ring-seal socket
- Three closed socket boss positions
- Fitted with screwed access cover

Material: PVC-U, with Rubber seals

Nominal Size (mm)	Part Number	Colour Option	Dimensions (mm)		
			A	B	C
110	4S374	●	95	118	114

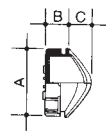

Access Saddle

- For providing access to BS EN 1329/BS EN 1453 plastic pipe after construction, or where an access pipe or branch is not suitable
- Fitted with screwed access cover

Material: PVC-U, with Rubber seals

Nominal Size (mm)	Part Number	Colour Option	Dimensions (mm)		
			A	B	C
110	4S275	● ●	103	35	35

Plugs

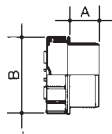

P/E Access Plug

- Fits into a ring-seal socket to provide an access point

Material: PVC-U

Nominal Size (mm)	Part Number	Colour Option	Dimensions (mm)	
			A	B
82	3S292	● ●	56	100
110	4S292	● ● ○	50	132
160	6S292	● ●	58	188

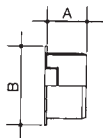

P/E Socket Plug

- With one closed boss socket position
- Fits into a ring-seal socket to provide a connection point for a 32mm [1¼"], 40mm [1½"] or 50mm [2"] waste pipe connection when fitted with the appropriate Boss Socket Adaptor (pages 25-26)

Material: PVC-U

Nominal Size (mm)	Part Number	Colour Option	Dimensions (mm)	
			A	B
110	4S296	● ● ○	54	132

Spares



Snap Cap

- Snap-on cap which retains the sealing ring in all standard Osma ring-seal fittings

Material: Polypropylene

Nominal Size (mm)	Part Number	Colour Option
82	3S116	● ●
110	4S116	● ● ○



T' Ring Seal

- Synthetic rubber sealing ring for all standard Osma ring-seal fittings

Material: EPDM

Nominal Size (mm)	Part Number
110	4S130
160	6S130

Product Details

Wavin OsmaSoil – PVC-U Solvent Weld system

Key			
P/E:	Pipe and fittings with both ends plain or with one plain end and one special end	S/SW:	Fittings with one or more ring-seal sockets but always one solvent socket
S/S:	Pipe and fittings with one or more ring-seal or push-fit sockets, but always one plain or special end	SW/S:	Fittings with one or more solvent sockets and one plain or special end
D/S:	Fittings with ring-seal or push-fit sockets at all ends	D/SW:	Fittings with solvent sockets at all ends

Pipe



Plain-Ended Pipe

- 110 /160mm sizes are made with Wavin Recycore technology – a multi-layer construction with over 50% recycled material in solid core
- 110 /160 mm pipe sizes are BS EN 1453-1:2000 kitemarked but have exactly the same performance characteristics as BS EN 1329-1:2000

Material: PVC-U

Nominal Size (mm)	Part Number	Colour Option	Length (m)
110	4S073	● ● ○	3
110	4S074	● ● ○	4
160	6S074	● ●	4

Brackets

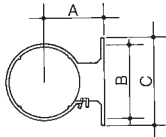

Pipe Bracket

- For support centres, see pages 10, 88 and 107

Material: PVC-U

Nominal Size (mm)	Part Number	Colour Option	Dimensions (mm)				Fixing Hole
			A	B	C	D	
110	4S082	● ● ○	94	120	140	25	6.5 dia
160	6S082	● ●	123	175	200	32	8 dia

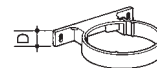
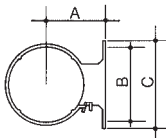

Socket Bracket

- Position in the recessed area adjacent to the sealing-ring housing
- For support centres, see pages 10, 88 and 107

Material: PVC-U

Nominal Size (mm)	Part Number	Colour Option	Dimensions (mm)				Fixing Hole
			A	B	C	D	
110	4S083	● ● ○	94	120	140	25	6.5 dia

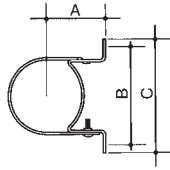

Pipe or Socket Bracket

- Multi-functional support component that can be used for pipes or sockets
- When using as a socket bracket, always position unit in the recessed area adjacent to the sealing-ring housing
- For support centres, see pages 10, 88 and 107

Material: BZP – Coated Mild Steel

Nominal Size (mm)	Part Number	Dimensions (mm)				Fixing Hole
		A	B	C	D	
110	4S084	94	160	180	20	7 dia
160	6S084	124	220	240	25	7 dia

Suspended Bracketing System



Adjustable Pipe Bracket Assembly

- Pack contains Threaded Rod, Threaded Bracket, Bracket Plate and Pipe/Socket Bracket
- For support centres, see pages 10, 88 and 107
- Not suitable for damp inaccessible voids

Material: BZP – Coated Mild Steel

Nominal Size (mm)	Part Number
110	4S086
160	6S086



Adjustable Socket Bracket and Brace Assembly

- Pack contains Threaded Rod, Threaded Bracket, Bracket Plate, two Adjustable Braces, and Pipe/Socket Bracket
- For support centres, see pages 10, 88 and 107
- Not suitable for damp inaccessible voids

Material: BZP – Coated Mild Steel

Nominal Size (mm)	Part Number
110	4S085

Product Details

Wavin OsmaSoil – PVC-U Solvent Weld system

Suspended Bracketing System – Components

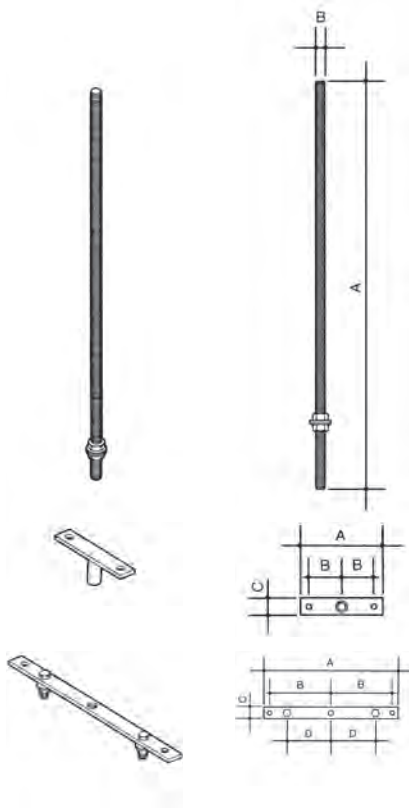

M8 Threaded Rod

Material: BZP – Coated Mild Steel

Nominal Size (mm)	Part Number	Dimensions (mm)	
		A	B
-	-	500	8

Threaded Bracket

Material: BZP – Coated Mild Steel

Nominal Size (mm)	Part Number	Dimensions (mm)		
		A	B	C
-	-	120	40	30

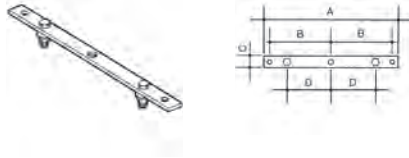

Bracket Plate

Material: BZP – Coated Mild Steel

Nominal Size (mm)	Part Number	Dimensions (mm)			
		A	B	C	D
-	-	240	110	20	80

Adjustable Brace

- Used for creating anchor points

Material: BZP – Coated Mild Steel

Nominal Size (mm)	Part Number	Dimensions (mm)		
		A min	A max	B
-	-	264	493	260

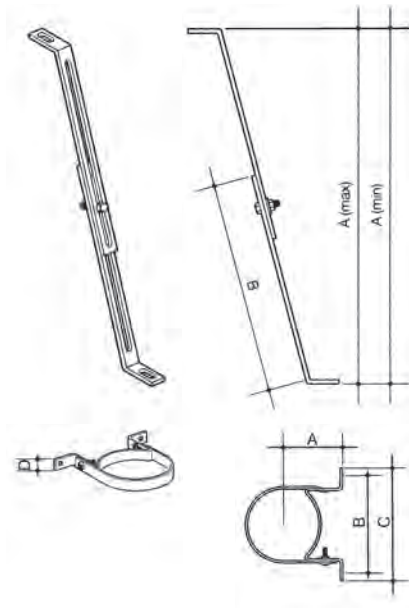

Pipe or Socket Bracket

Material: BZP – Coated Mild Steel

Nominal Size (mm)	Part Number	Dimensions (mm)				Fixing Hole
		A	B	C	D	
110	-	94	160	180	20	7 dia
160	-	124	220	240	25	7 dia

Sockets



D/SW Double Socket

- Solvent weld socket at each end

Material: PVC-U

Nominal Size (mm)	Part Number	Colour Option	Dimensions (mm)	
			A	B
110	4S104	● ● ○	98	2
160	6S104	● ●	119	3



D/S Double Socket - for repairs

- Push-fit ring-seal socket at each end
- Used as a slip coupler for making repairs

Material: PVC-U, with Rubber seals

Nominal Size (mm)	Part Number	Colour Option	Dimensions (mm)
			A
110	4S105	● ● ○	111
160	6S105	●	145

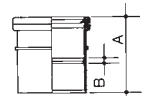

S/SW Single Socket

- One solvent weld socket and one push-fit ring-seal socket
- Used for creating a fixed ring-seal joint on a plain-ended pipe or fitting, or where an expansion joint is required to accommodate thermal movement

Material: PVC-U, with Rubber seals

Nominal Size (mm)	Part Number	Colour Option	Dimensions (mm)	
			A	B
110	4S124	● ● ○	105	2
160	6S124	● ●	135	2



Acoustic Socket

- Push-fit ring-seal socket at each end
- For acoustic performance and built in allowance for thermal expansion
- Can be used as an alternative to 4S124 (see pages 104-105 for full product details)

Material: PVC-U, with Rubber seals

Nominal Size (mm)	Part Number	Colour Option	Dimensions (mm)
			A
110	4S125	● ●	133

For installation tips see:

 WavinUK

Product Details

Wavin OsmaSoil – PVC-U Solvent Weld system

Connectors



Connector to Cast-Iron Socket

- Connector to BS 416 cast-iron soil socket

Material: Neoprene Synthetic Rubber

Nominal Size (mm)	Part Number	Colour Option	Dimensions (mm)	
			A	
110	4S206	●	66	

Reducers

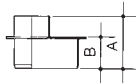

SW/S Reducer

- Spigot connects to 110mm PVC-U solvent weld socket to BS EN 1329/ BS EN 1453
- Socket connects to 50mm ABS or PVC-C solvent weld pipe to BS EN 1455-1/ BS EN 1566-1

Material: PVC-U

Nominal Size (mm)	Part Number	Colour Option	Dimensions (mm)	
			A	B
110x50	4S496 ♡	● ●	89	50

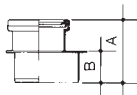

S/S Reducer

- Spigot connects to 110mm PVC-U solvent weld socket to BS EN 1329/ BS EN 1453
- Ring-seal socket connects to 82mm PVC-U pipe to BS EN 1329

Material: PVC-U, with Rubber seals

Nominal Size (mm)	Part Number	Colour Option	Dimensions (mm)	
			A	B
110x82	4S095 ♡	● ●	103	53

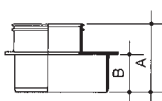
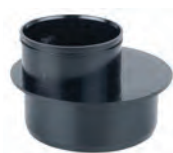

SW/S Reducer

- Spigot connects to 160mm PVC-U solvent weld socket to BS EN 1329/ BS EN 1453
- Solvent weld socket connects to 110mm PVC-U pipe to BS EN 1329/ BS EN 1453

Material: PVC-U

Nominal Size (mm)	Part Number	Colour Option	Dimensions (mm)	
			A	B
160x110	6S499 ♡	● ●	117	65

Expansion Cap



Expansion Cap

- With integral ring-seal
- Converts Osma Solvent Weld Soil sockets to push-fit expansion sockets
- See page 87 for advice on accommodating thermal movement

Material: PVC-U, with Rubber seals

For installation tips see:



WavinUK

Nominal Size (mm)	Part Number	Colour Option	Dimensions (mm)	
			A	B
110	4S416	● ●	22	

Bends

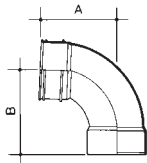

D/SW Bend – 87.5°

- Two solvent weld sockets

Material: PVC-U

Nominal Size (mm)	Part Number	Colour Option	Dimensions (mm)	
			A	B
110	4S461 ▾	● ● ○	152	166
160	6S461 ▾	● ●	231	232

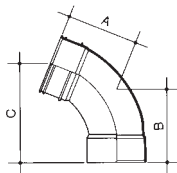

D/SW Bend – 67.5°

- Two solvent weld sockets

Material: PVC-U

Nominal Size (mm)	Part Number	Colour Option	Dimensions (mm)		
			A	B	C
110	4S462 ▾	● ●	141	138	192

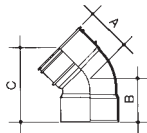

D/SW Bend – 45°

- Two solvent weld sockets

Material: PVC-U

Nominal Size (mm)	Part Number	Colour Option	Dimensions (mm)		
			A	B	C
110	4S463 ▾	● ●	87	87	148
160	6S463 ▾	● ●	128	111	204

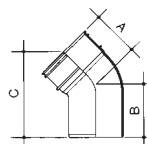

SW/S Bend – 45°

- One plain end and one solvent weld socket

Material: PVC-U

Nominal Size (mm)	Part Number	Colour Option	Dimensions (mm)		
			A	B	C
110	4S263 ▾	● ●	87	105	167

Product Details

Wavin OsmaSoil – PVC-U Solvent Weld system

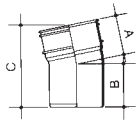

SW/S Bend – 11.25°

- One plain end and one solvent weld socket

Material: PVC-U

Nominal Size (mm)	Part Number	Colour Option	Dimensions (mm)		
			A	B	C
110	4S268	● ●	75	88	162

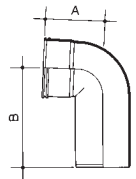

SW/S Long-Tail Bend – 87.5°

- One plain end and one solvent weld socket

Material: PVC-U

Nominal Size (mm)	Part Number	Colour Option	Dimensions (mm)	
			A	B
110	4S260	● ●	115	195

Offset Bends

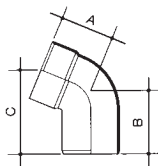

SW/S Offset Bend – 67.5° (Bottom)

- One solvent weld socket and one push-fit ring-seal socket
- Minimum achievable offset: 137mm

Material: PVC-U

Nominal Size (mm)	Part Number	Colour Option	Dimensions (mm)		
			A	B	C
110	4S435	● ● ○	99	105	143

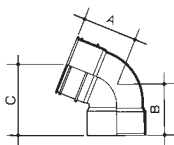

D/SW Offset Bend – 67.5° (Top)

- Two solvent weld sockets
- Minimum achievable offsets: 196mm

Material: PVC-U

Nominal Size (mm)	Part Number	Colour Option	Dimensions (mm)		
			A	B	C
110	4S450	● ●	108	102	123

Manifold

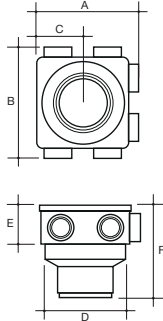
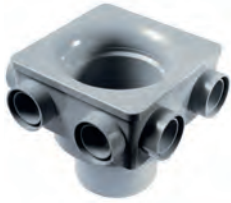

For installation tips see:

YouTube
WavinUK

6 Boss Manifold

- One plain end and one solvent weld socket
- 6 boss connection points (No boss adaptors required)
- Dual 40/50mm solvent weld connection
- Compact design, 163mm body sits easily into 200mm drilled or formed hole
- Branch low in fitting: 132mm from centreline of branch horizontal inlet to 50mm spigot invert
- Horizontal waste connection: instead of vertical connection – no upstanding bends required

Material: PVC-U

Nominal Size (mm)	Part Number	Colour Option	Dimensions (mm)					
			A	B	C	D	E	F
110	4S597	●	204	222	94	163	79	184

Single Branches

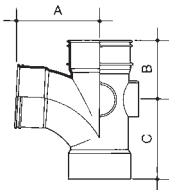

D/SW Single Branch – 87.5°

- Three solvent weld sockets
- Three closed boss socket positions on 110mm fitting
- 160mm fitting has no bosses

Material: PVC-U

Nominal Size (mm)	Part Number	Colour Option	Dimensions (mm)		
			A	B	C
110	4S490 ▽	● ●	159	112	152
160	6S490 ▽	● ●	222	161	240

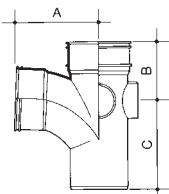

SW/S Single Branch – 87.5°

- One plain end and two solvent weld sockets
- Three closed boss socket positions

Material: PVC-U

Nominal Size (mm)	Part Number	Colour Option	Dimensions (mm)		
			A	B	C
110	4S290 ▽	● ●	159	112	152

Product Details

Wavin OsmaSoil – PVC-U Solvent Weld system

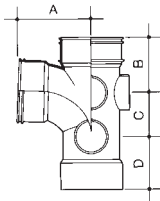

D/SW Single 5-Boss Branch – 87.5°

- Three solvent weld sockets
- Five closed boss socket positions, of which two are positioned 84mm below the centre-line of the branch entry. These can be used for lowlevel waste connections

Material: PVC-U

Nominal Size (mm)	Part Number	Colour Option	Dimensions (mm)			
			A	B	C	D
110	4S495 ♡	● ●	139	108	84	99

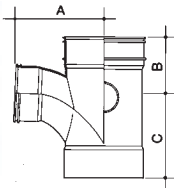

D/SW Unequal Single Branch – 87.5°

- Two 160mm solvent weld sockets
- One 110mm solvent weld socket on the branch
- Two closed boss socket positions

Material: PVC-U

Nominal Size (mm)	Part Number	Colour Option	Dimensions (mm)		
			A	B	C
160	6S498 ♡	● ●	167	130	155

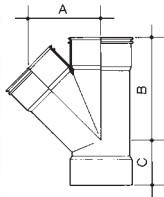

D/SW Single Branch – 45°

- Three solvent weld sockets

Material: PVC-U

Nominal Size (mm)	Part Number	Colour Option	Dimensions (mm)		
			A	B	C
110	4S410 ♡	● ●	136	192	85

Double Branch

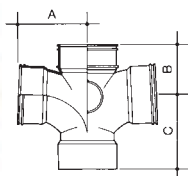

D/SW Double Branch – 87.5°

- Four solvent weld sockets
- Two closed boss socket positions
- Do NOT use for connecting back-to-back WCs in horizontal float installations: see relevant parts of BS EN 12056:2000

Material: PVC-U

Nominal Size (mm)	Part Number	Colour Option	Dimensions (mm)		
			A	B	C
110	4S430 ♡	● ●	141	110	144

Corner Branch

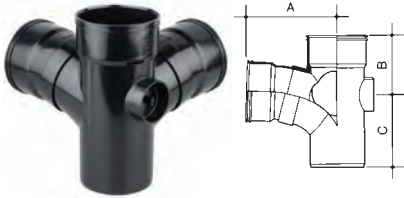

SW/S Corner Branch – 87.5°

- One plain end and three solvent weld sockets
- One closed boss socket position

Material: PVC-U

Nominal Size (mm)	Part Number	Colour Option	Dimensions (mm)		
			A	B	C
110	4S491	● ●	179	113	144

Boss Socket Adaptor



SW/S Solvent Weld Boss Adaptor

- Suitable for all OsmaSoil incorporating boss socket positions
- Connects to 32mm [1¼"], 40mm [1½"] or 50mm [2"] solvent weld plastic pipe to BS EN 1455-1/BS EN 1566-1
- Horizontal adaptors have an inbuilt 2.5° fall

Material: PVC-U

Nominal Size (mm)	Part Number	Colour Option	Dimensions (mm)	
			A	B
32	2S298	● ● ○	41	20
40	2S299	● ● ○	45	24
50	2S403	● ● ○	53	30

Bossed Pipes

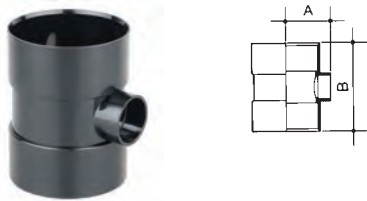

D/SW Bossed Pipe

- Two solvent weld sockets. One closed boss socket position
- One solvent weld socket for 32mm [1¼"] or 40mm [1½"] solvent weld plastic pipe to BS EN 1455-1/BS EN 1566-1

Material: PVC-U

Nominal Size (mm)	Part Number	Colour Option	Dimensions (mm)	
			A	B
110x32	4S483	● ●	74	150
110x40	4S484	● ●	77	150

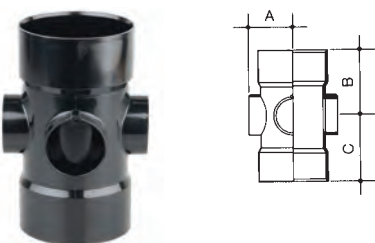

D/SW Bossed Pipe

- Two solvent weld sockets
- Three closed boss socket positions and one open to receive appropriate Boss Socket Adaptor

Material: PVC-U

Nominal Size (mm)	Part Number	Colour Option	Dimensions (mm)		
			A	B	C
110	4S586	● ●	75	106	109

Product Details

Wavin OsmaSoil – PVC-U Solvent Weld system

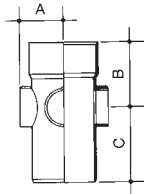

SW/S Bossed Pipe

- One plain end and one solvent weld socket
- Three closed boss socket positions and one open to receive appropriate Boss Socket Adaptor

Material: PVC-U

Nominal Size (mm)	Part Number	Colour Option	Dimensions (mm)		
			A	B	C
110	4S585	● ●	75	106	126

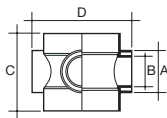

D/SW Short Bossed Pipe

- Three closed boss socket positions for use with the appropriate Boss Socket Adaptor
- Three closed 40mm spigot tail positions also allow for direct connection of 40mm solvent weld sockets

Material: PVC-U

Nominal Size (mm)	Part Number	Colour Option	Dimensions (mm)			
			A	B	C	D
110	4S588	● ● ○	56	43	124	74

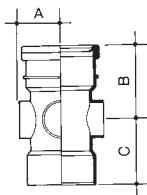

S/SW Bossed Pipe

- One solvent weld socket and one push-fit ring-seal socket
- Three closed boss socket positions and one open to receive appropriate Boss Socket Adaptor

Material: PVC-U

Nominal Size (mm)	Part Number	Colour Option	Dimensions (mm)		
			A	B	C
110	4S590	● ●	74	111	98

Strap Boss

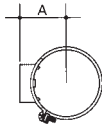

Strap Boss

- For making side connections on BS EN 1329/BS EN 1453 plastic pipe after construction
- Use with required Boss Socket Adaptor (pages 25-26)

Material: PVC-U

Nominal Size (mm)	Part Number	Colour Option	Dimensions (mm)
			A
110	4S319	● ● ○	77

Access Fittings

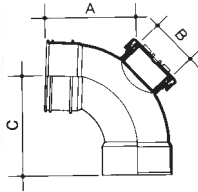

D/SW Access Bend – 87.5°

- Two solvent weld sockets
- Fitted with screwed access cover

Material: PVC-U

Nominal Size (mm)	Part Number	Colour Option	Dimensions (mm)		
			A	B	C
110	4S469 ♡	● ●	152	80	166

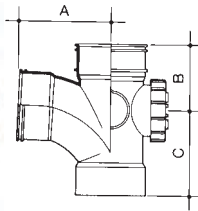

D/SW Access Bend – 87.5°

- Three solvent weld sockets
- Two closed boss socket positions
- Fitted with screwed access cover

Material: PVC-U

Nominal Size (mm)	Part Number	Colour Option	Dimensions (mm)		
			A	B	C
110	4S493 ♡	● ●	159	112	152

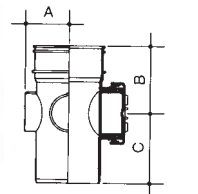

SW/S Bossed Access Pipe

- One plain end and one solvent weld socket
- Three closed boss socket positions
- Fitted with screwed access cover

Material: PVC-U

Nominal Size (mm)	Part Number	Colour Option	Dimensions (mm)		
			A	B	C
110	4S574 ♡	● ●	75	107	118
160	6S474 ♡	● ●	124	132	150

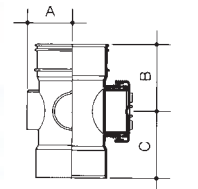

D/SW Bossed Access Pipe

- Two solvent weld sockets
- Three closed boss socket positions
- Fitted with screwed access cover

Material: PVC-U

Nominal Size (mm)	Part Number	Colour Option	Dimensions (mm)		
			A	B	C
110	4S474 ♡	● ●	85	107	114

Product Details

Wavin OsmaSoil – PVC-U Solvent Weld system

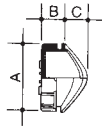

Access Saddle

- For providing access to BS EN 1329/BS EN 1453 plastic pipe after construction, or where an access pipe or branch is not suitable
- Fitted with screwed access cover

Material: PVC-U

Nominal Size (mm)	Part Number	Colour Option	Dimensions (mm)		
			A	B	C
110	4S275	● ●	103	35	35

Plugs

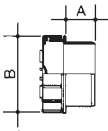

P/E Access Plug

- Fits into a solvent weld socket to provide an access point
- Fitted with screwed access cover

Material: PVC-U

Nominal Size (mm)	Part Number	Colour Option	Dimensions (mm)	
			A	B
82	3S292	● ●	56	100
110	4S292	● ● ○	50	132
160	6S292	● ●	58	188

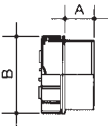

SW/S Access Plug

- Glues over a pipe spigot to provide an access point
- Fitted with screwed access cover

Material: PVC-U

Nominal Size (mm)	Part Number	Colour Option	Dimensions (mm)	
			A	B
110	4S492	● ●	50	137

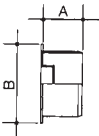

P/E Socket Plug

- One closed boss socket position
- Fits into a solvent weld socket to provide a connection point for a 32mm [1¼"], 40mm [1½"] or 50mm [2"] waste-pipe connection when fitted with the appropriate boss socket adaptor

Material: PVC-U

Nominal Size (mm)	Part Number	Colour Option	Dimensions (mm)	
			A	B
110	4S296	● ● ○	54	132

Product Details

Wavin OsmaSoil – WC connectors

WC Manifold Branches (incorporating gasket)

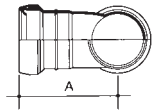

S/SW Manifold Branch – Straight

- One solvent weld and one push-fit socket (right hand illustrated)

Material: PVC-U

Nominal Size (mm)	Part Number	Colour Option	Dimensions (mm)	
			A	Effective Length
110	4S601	○	180	132

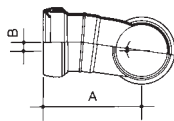

S/SW Manifold Branch – 8°

- One solvent weld and one push-fit socket (right hand illustrated)

Material: PVC-U

Nominal Size (mm)	Part Number	Colour Option	Dimensions (mm)		
			A	B	Effective Length
110 LH	4S602	○	180	16	132
110 RH	4S612	○	180	16	132

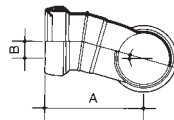

S/SW Manifold Branch – 15.5°

- One solvent weld and one push-fit socket (right hand illustrated)

Material: PVC-U

Nominal Size (mm)	Part Number	Colour Option	Dimensions (mm)		
			A	B	Effective Length
110 LH	4S603	○	180	32	132
110 RH	4S613	○	180	32	132

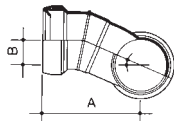

S/SW Manifold Branch – 23°

- One solvent weld and one push-fit socket (right hand illustrated)

Material: PVC-U

Nominal Size (mm)	Part Number	Colour Option	Dimensions (mm)		
			A	B	Effective Length
110 LH	4S604	○	180	48	132
110 RH	4S614	○	180	48	132

NOTE: All Manifold Branches are fitted with a gasket for direct connection to the outlets of WCs manufactured to BS 5503 See page 95 and BS EN 12056:2000 on the provision of access

Product Details

Wavin OsmaSoil – WC connectors

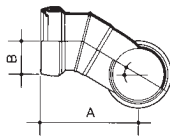

S/SW Manifold Branch – 30.5°

- One solvent weld and one push-fit socket (right hand illustrated)

Material: PVC-U

Nominal Size (mm)	Part Number	Colour Option	Dimensions (mm)		
			A	B	Effective Length
110 LH	4S605	○	180	64	132
110 RH	4S615	○	180	64	132

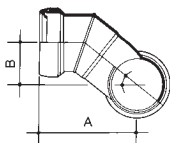

S/SW Manifold Branch – 38°

- One solvent weld and one push-fit socket (right hand illustrated)

Material: PVC-U

Nominal Size (mm)	Part Number	Colour Option	Dimensions (mm)		
			A	B	Effective Length
110 LH	4S606	○	180	80	132
110 RH	4S616	○	180	80	132

WC Connectors (incorporating gasket)

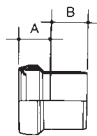

P/E Connector – 2.5°

- One plain end

Material: PVC-U

Nominal Size (mm)	Part Number	Colour Option	Dimensions (mm)	
			A	B
110	4S791	○	53	63

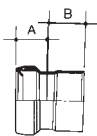

SW/S Connector – 2.5°

- One solvent weld socket

Material: PVC-U

Nominal Size (mm)	Part Number	Colour Option	Dimensions (mm)	
			A	B
110	4S792	○	53	63

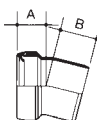

P/E Connector – 14°

- One plain end

Material: PVC-U

Nominal Size (mm)	Part Number	Colour Option	Dimensions (mm)	
			A	B
110	4S711	○	53	63

NOTE: Manifold Branches and WC Connectors are fitted with a gasket for direct connection to the outlets of WCs manufactured to BS 5503

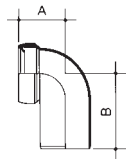

P/E Connector – 90°

- One plain end

Material: PVC-U

Nominal Size (mm)	Part Number	Colour Option	Dimensions (mm)	
			A	B
110	4S771 ♡	○	109	173

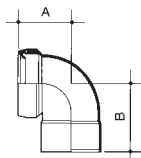

SW/S Connector – 90°

- One solvent weld socket

Material: PVC-U

Nominal Size (mm)	Part Number	Colour Option	Dimensions (mm)	
			A	B
110	4S772 ♡	○	109	134

WC Connectors (gasket to be fitted)

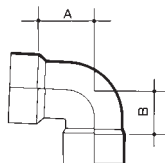

SW/S Connector – 87.5°

- One solvent weld socket
- For direct connection to WCs to BS 1213 when fitted with the appropriate Gasket 4S120 or 4S121 (see page 96)

Material: PVC-U

Nominal Size (mm)	Part Number	Colour Option	Dimensions (mm)	
			A	B
110	4S745 ♡	○	106	77

WC Gasket



WC Gasket

- For use with Connectors 4S730*, 4S731*, 4S745 and 4S746* (*= discontinued)
- Connects to WC spigots as follows:
4S121 suits 4" to 4¼" spigots
4S120 suits 4¼" to 4½" spigots

Material: Synthetic Rubber

Nominal Size (mm)	Part Number	Colour Option	Dimensions (inch)
			WC Spigot
110	4S121	○	4" to 4¼"
110	4S120	○	4¼" to 4½"

NOTE: Manifold Branches and WC Connectors are fitted with a gasket for direct connection to the outlets of WCs manufactured to BS 5503

See page 95 and BS EN 12056:2000 on the provision of access

Product Details

Wavin OsmaSoil – WC connectors

WC Connectors (ancillaries)

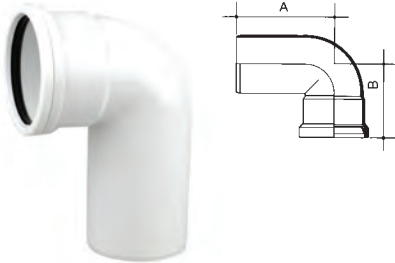

S/S Long-Tail Bend – 87.5°

- For use with WC Connectors (pages 46-47)
- Do NOT use as a WC connector

Material: PVC-U

Nominal Size (mm)	Part Number	Colour Option	Dimensions (mm)	
			A	B
110	4S790 ♡	○	195	134



Plain-Ended Pipe – 600mm

- For use with WC Connectors where connection to SVP is visible

Material: PVC-U

Nominal Size (mm)	Part Number	Colour Option	Dimensions (mm)
			Length
110	4S600 ♡△	○	600

Easy-Fit Pan Connectors



Easy-Fit Connector – Straight

- For use where the WC outlet is horizontal to the branch connection
- Fitted with a gasket for direct connection to the outlets of WCs manufactured to BS 5503
- Spigot end of 3½" Connector WC003 incorporates gasket for direct insertion into plain end of 3½" cast-iron pipe to BS 416
- Spigot end of 4" Connector WC004 incorporates gasket for direct insertion into plain end of 4" pipe e.g. cast-iron, plastic or clay

Material: Polypropylene

Nominal Size (inch)	Part Number	Colour Option	Dimensions (mm)	
			A	B
3½"	WC003	○	116	52
4"	WC004	○	116	52

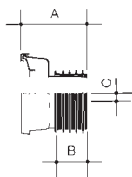

Easy-Fit Connector – Offset

- For use where the WC outlet is not directly in line with the branch connection. Correct alignment obtained by turning the connector
- Fitted with a gasket for direct connection to the outlets of WCs manufactured to BS 5503
- Spigot end of 4" Connector WC004 incorporates gasket for direct insertion into plain end of 4" pipe e.g. cast-iron, plastic or clay

Material: Polypropylene

Nominal Size (inch)	Part Number	Colour Option	Dimensions (mm)		
			A	B	C
4"	WC204	○	116	52	16

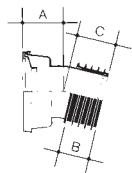

Easy-Fit Connector – 14°

- Converts a horizontal WC outlet to an angle of 14° (76°)
- Spigot end of 4" Connector WC144 incorporates gasket for direct insertion into plain end of 4" pipe e.g. cast-iron, plastic or clay

Material: Polypropylene

Nominal Size (inch)	Part Number	Colour Option	Dimensions (mm)		
			A	B	C
4"	WC144	○	73	52	67

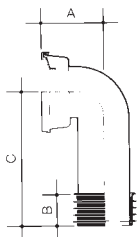

Easy-Fit Connector – 90°

- Converts a horizontal WC outlet to a left or right-hand 'S' or 'P' trap
- Can be cut to required length
- Spigot end incorporates gasket for direct insertion into plain end of 4" pipe e.g. cast-iron, plastic or clay

Material: Polypropylene

Nominal Size (inch)	Part Number	Colour Option	Dimensions (mm)		
			A	B	C
4"	WC904	○	107	52	236

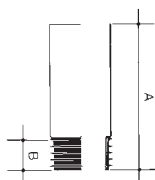

Straight Extension Piece

- One plain end
- Makes up the distance between any Easy-Fit Connector and soil or drain pipe connection
- Spigot end incorporates gasket for direct insertion into plain end of 4" pipe e.g. cast-iron, plastic or clay

Material: Polypropylene

Nominal Size (inch)	Part Number	Colour Option	Dimensions (mm)	
			A	B
4"	WC404	○	255	52

Product Details

Wavin OsmaSoil – Ancillaries

Terminal Fittings

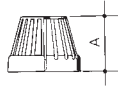

Balloon Grating

Material: PVC-U

Nominal Size (mm)	Part Number	Colour Option	Dimensions (mm)		
			A		
82	3S302	● ●	94		
110	4S302	● ● ○	90		
160	6S302	●	160		

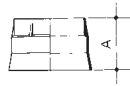

Weathering Collar

- Used to maintain a watertight seal between pipe and traditional lead or aluminium flashing
- To be solvent welded to pipe using Solvent Cement Filler 4S394

Material: PVC-U

Nominal Size (mm)	Part Number	Colour Option	Dimensions (mm)		
			A		
82	3S300	● ●	62		
110	4S300	● ● ○	86		

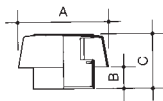

SW/S Vent Cowl

- Provides an alternative weather-proof termination for soil and vent pipe, or outlet for a mechanical-ventilation system
- Can be used in a vertical or horizontal position

Material: PVC-U

Nominal Size (mm)	Part Number	Colour Option	Dimensions (mm)		
			A	B	C
110	4S310 ▽	● ● ○	172	40	100

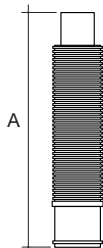

Flexible Vent Pipe

- Connects to ridge tile adaptor

Material: PVC-U and Polypropylene

Nominal Size (mm)	Part Number	Colour Option	Dimensions (mm)		
			A		
110	4S308	●	500		

Air Admittance Valves

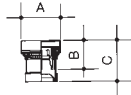

OsmaVent 40 Air Admittance Valve

- For direct connection to a 32mm [1¼"] or 40mm [1½"] waste spigot
- Allows air into discharge pipe systems without allowing foul air to escape
- See pages 99 and 100, BBA and BS EN 12056:2000 for ventilation requirements
- BBA certificated (Certificate No. 86/1643)

Material: ABS

Nominal Size (mm)	Part Number	Colour Option	Dimensions (mm)		
			A	B	C
32/40	4S303 ▲	○	66	40	71

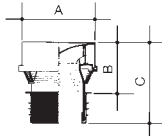

OsmaVent 110 Air Admittance Valve

- A1 rated to BS EN 12380
- For direct connection to a 110mm spigot on BS EN 1329/BS EN 1453 soil pipe
- For 82mm pipe, the rubber seal is removed, a short length of pipe welded to the socket, and the pipe fitted into a Socket 3S124
- Allows air into discharge pipe systems without allowing foul air to escape
- See pages 99 and 100, BBA and BS EN 12056:2000 for ventilation requirements
- BBA certificated (Certificate No. 86/1643)

Material: ABS

Nominal Size (mm)	Part Number	Colour Option	Dimensions (mm)		
			A	B	C
110	4S304 ▲	○	130	85	135

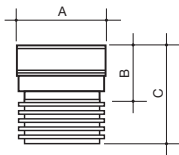

Domestic Air Admittance Valve

- A2 rated to BS EN 12380
- For direct connection to a 110mm spigot on BS EN 1329/BS EN 1453 soil pipe
- Allows air into discharge pipe systems without allowing foul air to escape
- See pages 99 and 100, BS EN 12056:2000 for ventilation requirements

Material: ABS

Nominal Size (mm)	Part Number	Colour Option	Dimensions (mm)		
			A	B	C
110	4S306 ▲	●	104	66	116

For installation tips see:



WavinUK

Product Details

Wavin OsmaSoil – Ancillaries

Pipe Flashings

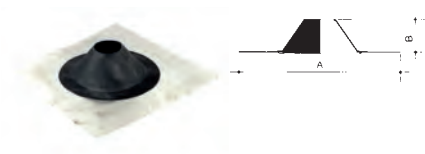

Varipitch Pipe Flashing for Flat Roofs

- For use with 82mm and 110mm soil pipe to BS EN 1329 which penetrates a flat roof

Material: Aluminium base, EPDM Rubber cone

Nominal Size (mm)	Part Number	Dimensions (mm)	
		A	B
–	4S281	400x400	85

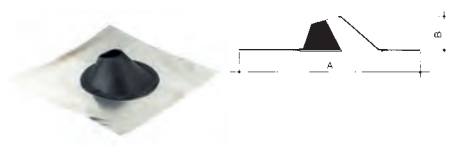

Varipitch Pipe Flashing for Pitched Roofs

- For use with 82mm and 110mm soil pipe to BS 1329 which penetrates a pitched roof

Material: Aluminium base, EPDM Rubber cone

Nominal Size (mm)	Part Number	Dimensions (mm)	
		A	B
–	4S283	450x450	85

Roof Outlets

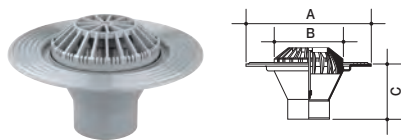

SW/S Domed Roof Outlet

- Outlet capacity (outlet at centre of roof):
82mm outlet 2.97 l/s; 143m² max. roof area
110mm outlet 4.35 l/s; 209m² max. roof area
- Fitted with:
82mm outlet solvent-weld socket
110mm outlet solvent-weld socket

Material: PVC-U

Nominal Size (mm)	Part Number	Colour Option	Dimensions (mm)		
			A	B	C
82	3S414	●	270	130	124
110	4S414	●	338	188	147

Rainwater Hopper and Shoe

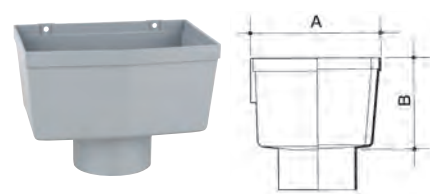

Hopper Head

- Flow capacity 3.78 l/s, 6.47 l/s
- Spigot sized for 82/110mm socket

Material: PVC-U

Nominal Size (mm)	Part Number	Colour Option	Dimensions (mm)		
			A	B	Width
82	3S530	●	260	190	255
110	4S326	● ●	132	183	255

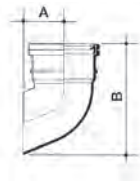

S/S Rainwater Pipe Shoe

- Use with Socket Bracket 3S083/4S083
- One plain end and one ring-seal or socket

Material: PVC-U

Nominal Size (mm)	Part Number	Colour Option	Dimensions (mm)	
			A	B
82	3S288	●	60	162
110	4S288	● ●	65	243

Cleaners, Solvent Cements, Lubricants



Degreasing Cleaner No. 1

- Use for cleaning solvent weld joints prior to assembly.
- See page 106 for safety information
- See page 10 & 106 for usage allowances

Size (ml)	Part Number
250	4S380



Solvent Cement No. 2

- Use for making solvent weld joints
- See page 106 for safety information
- See page 10 & 106 for usage allowances

Size (ml)	Part Number
125	4S383 ♡
250	4S384 ♡
500	4S385 ♡



Solvent Cement Filler

- See page 106 for safety information

Size (ml)	Part Number
140	4S394



Silicone Lubricant

- Use to aid assembly of ring-seal socket and spigot joints
- See page 10 & 106 for usage allowances

Size	Part Number
50g tube	4S391
400ml spray can	4S392

Product Details

Wavin OsmaWeld – ABS Solvent Weld waste

Pipe



Plain-Ended Pipe

Material: ABS

Nominal Size (mm)	Part Number	Colour Option	Length (m)
32	4Z073 ▾	● ○	3
40	5Z073 ▾	● ○	3
50	2Z073 ▾	● ○	3
32	4Z074 ▾	●	4
40	5Z074 ▾	●	4
50	2Z074 ▾	●	4

Bracket

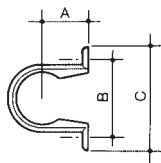

Pipe Bracket

- For support centres, see pages 10, 88 and 107

Material: ABS

Nominal Size (mm)	Part Number	Colour Option	Dimensions (mm)		
			A	B	C
32	4Z081 ▾	● ● ○	32	67	85
40	5Z081 ▾	● ● ○	36	73	92
50	2Z081 ▾	● ● ○	61	79	100

Sockets

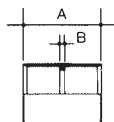

Double Socket

- For connecting lengths of ABS pipe
- Use Universal Connectors 4W102, 5W102 and 2W102 (page 58) for connecting to other materials

Material: ABS

Nominal Size (mm)	Part Number	Colour Option	Dimensions (mm)	
			A	B
32	4Z104 ▾	● ● ○	42	3
40	5Z104 ▾	● ● ○	48	3
50	2Z104 ▾	● ● ○	65	3

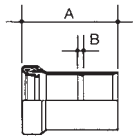

Expansion Socket – with Solvent Socket Tail

- For creating an expansion joint where provision for thermal movement is required. See page 87 for details
- Solvent weld socket and push-fit ring-seal socket Push-fit socket connects to 32mm [1¼"], 40mm [1½"] or 50mm [2"] pipe to BS EN 1451-1/ BS EN 1455-1 and BS EN 1566-1
- Also connects to copper pipe to BS 659 and BS 2871

Material: ABS

Nominal Size (mm)	Part Number	Colour Option	Dimensions (mm)	
			A	B
32	4Z124 ▾	● ○	72	3
40	5Z124 ▾	● ○	78	3
50	2Z124 ▾	○	93	3

Bends

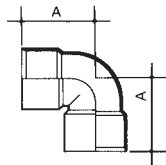

Knuckle Bend – 90°

Material: ABS

Nominal Size (mm)	Part Number	Colour Option	Dimensions (mm)	
			A	
32	4Z160 ▾	● ● ○	41	
40	5Z160 ▾	● ● ○	46	
50	2Z160 ▾	● ● ○	64	

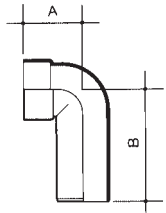

Long-Tail Spigot Bend – 90°

Material: ABS

Nominal Size (mm)	Part Number	Colour Option	Dimensions (mm)	
			A	B
32	4Z260 ▾	● ● ○	40	85
40	5Z260 ▾	● ● ○	49	92
50	2Z260 ▾	● ● ○	62	100

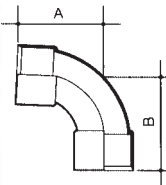

Bend – 87.5°

Material: ABS

Nominal Size (mm)	Part Number	Colour Option	Dimensions (mm)	
			A	B
32	4Z161 ▾	● ● ○	55	55
40	5Z161 ▾	● ● ○	66	66
50	2Z161 ▾	● ● ○	82	98

Product Details

Wavin OsmaWeld – ABS Solvent Weld waste

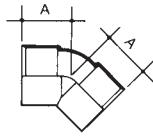

Bend – 45°

Material: ABS

Nominal Size (mm)	Part Number	Colour Option	Dimensions (mm)	
			A	
32	4Z163	● ● ○	34	
40	5Z163	● ● ○	38	
50	2Z163	● ● ○	47	



Bend – 45° Male and Female

Material: ABS

Nominal Size (mm)	Part Number	Colour Option	
			32
40	5Z263	● ● ○	

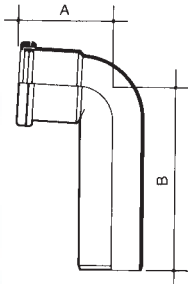

Long-Tail Bend – 87.5°

- One plain end and one push-fit ring-seal socket
- Push-fit socket connects to 50mm [2"] pipe to BS EN 1451-1/BS EN 1455-1 and BS EN 1566-1
- Also connects to copper pipe to BS 659 and BS 2871
- See page 87 for advice on accommodating thermal movement

Material: ABS

Nominal Size (mm)	Part Number	Colour Option	Dimensions (mm)	
			A	B
50	2Z359	●	80	152

Tees

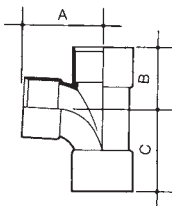

Tee – 87.5°

Material: ABS

Nominal Size (mm)	Part Number	Colour Option	Dimensions (mm)		
			A	B	C
32	4Z190	● ● ○	49	40	55
40	5Z190	● ● ○	59	46	59
50	2Z190	● ● ○	70	56	76

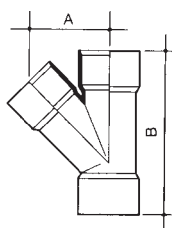

Tee – 45°

Material: ABS

Nominal Size (mm)	Part Number	Colour Option	Dimensions (mm)	
			A	B
32	4Z210	○	56	112
40	5Z210	● ● ○	61	126
50	2Z210	● ● ○	76	146

Cross Tee

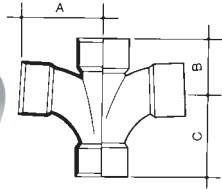

Cross – 87.5°

- **NOTE:** Should not be used in a horizontal position

Material: ABS

Nominal Size (mm)	Part Number	Colour Option	Dimensions (mm)		
			A	B	C
40	5Z230	○	63	52	62
50	2Z230	○	97	62	84

Plug

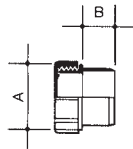

P/E Access Plug

- Fits into a solvent weld socket to provide an access point
- Fitted with screwed access cover
- See page 88 and BS EN 12056:2000 regarding provision of access

Material: ABS

Nominal Size (mm)	Part Number	Colour Option	Dimensions (mm)	
			A	B
32	4Z292	● ● ○	41	20
40	5Z292	● ● ○	48	23
50	2Z292	● ● ○	60	32

Connectors and Adaptors

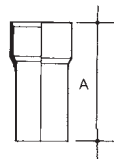

Straight Adaptor

- Push fit to solvent weld

Material: ABS

Nominal Size (mm)	Part Number	Colour Option	Dimensions (mm)
			A
32	4Z120	○	66
40	5Z120	○	69

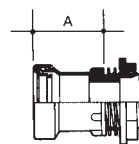

Straight Tank Connector

- Flanged, threaded connector, and push-fit ring-seal socket
- Push-fit socket connects to 32mm [1¼"] or 40mm [1½"] pipe to BS EN 1451-1/BS EN 1455-1 and BS EN 1566-1
- Also connects to copper pipe to BS 659 and BS 2871
- Includes fibre washers

Material: Polypropylene

Nominal Size (mm)	Part Number	Colour Option	Dimensions (mm)
			A
32	4Z185	○	53
40	5Z185	○	56

Product Details

Wavin OsmaWeld – ABS Solvent Weld waste

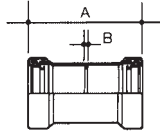

Universal Connector

- Two push-fit ring-seal sockets
- Connects to 32mm [1¼"] or 40mm [1½"] pipe to BS EN 1451-1/ BS EN 1455-1 and BS EN 1566-1
- Also connects to copper pipe to BS 659 and BS 2871

Material: Polypropylene

Nominal Size (mm)	Part Number	Colour Option	Dimensions (mm)	
			A	B
32	4W102	● ● ○	89	3
40	5W102	● ● ○	95	3
50	2W102	●	105	3

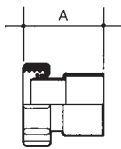

Male Cap and Liner

- Male threaded nut connector, and solvent weld socket
- Nut connects to 1¼" or 1½" BSPT threaded waste outlets
- Solvent weld socket connects to 32mm [1¼"] or 40mm [1½"] ABS or PVC-C solvent weld waste pipe to BS EN 1455-1 and BS EN 1566-1

Material: PVC-U

Nominal Size (mm)	Part Number	Colour Option	Dimensions (mm)
			A
32	4Z363	○	63
40	5Z363	○	63

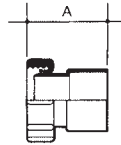

Female Cap and Liner

- Female threaded nut connector, and solvent weld socket
- Nut connects to 1¼" or 1½" BSPT threaded waste outlets
- Solvent weld socket connects to 32mm [1¼"] or 40mm [1½"] ABS or PVC-C solvent weld waste pipe to BS EN 1455-1 and BS EN 1566-1

Material: PVC-U

Nominal Size (mm)	Part Number	Colour Option	Dimensions (mm)
			A
40	5Z364	○	63

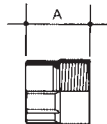

Female Iron Connector

- Threaded socket connector, and solvent weld socket
- Threaded socket connects to 1¼", 1½" or 2" BSPT male iron spigot
- Solvent weld socket connects to 32mm [1¼"], 40mm [1½"], or 50mm [2"] plastic waste pipe to BS EN 1455-1 and BS EN 1566-1

Material: ABS

Nominal Size (mm)	Part Number	Colour Option	Dimensions (mm)
			A
32	4Z127	○	50
40	5Z127	○	53

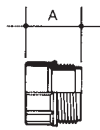

Male Iron Connector

- Threaded spigot connector, and solvent weld socket
- Threaded spigot connects to 1¼", 1½" or 2" BSPT female iron sockets
- Solvent weld socket connects to 32mm [1¼"], 40mm [1½"], or 50mm [2"] plastic waste pipe to BS 5255

Material: ABS

Nominal Size (mm)	Part Number	Colour Option	Dimensions (mm)	
			A	
32	4Z128 ♡	○	44	
40	5Z128 ♡	○	47	
50	2Z128 ♡	○	53	

Reducers

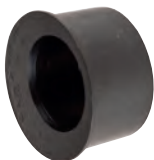

Socket Reducer

- One P/E and one solvent weld socket
- Allows connection of a 32mm [1¼"] waste pipe to either 40mm [1½"] or 50mm [2"] S/W sockets
- Also allows a 40mm [1½"] pipe to be connected to a 50mm [2"] S/W socket

Material: ABS

Nominal Size (mm)	Part Number	Colour Option
50x32	2Z088	● ● ○
50x40	2Z086	● ● ○

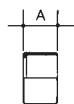

Socket Reducer

- Fits inside a 40mm [1½"] solvent weld socket to BS EN 1455-1
- Allows connection of a 32mm [1¼"] waste pipe to BS EN 1455-1

Material: ABS

Nominal Size (mm)	Part Number	Colour Option	Dimensions (mm)	
			A	
40x32	5Z455	● ● ○	26	

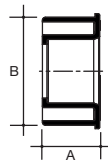

Waste to Overflow Reducer

- Fits inside a solvent weld waste socket to BS EN 1455-1 and BS EN 1566-1
- Allows connection of 21.5mm pipe

Material: ABS

Nominal Size (mm)	Part Number	Colour Option	Dimensions (mm)	
			A	B
32x21.5	1E344	● ○	19	36
40x21.5	1E346	● ○	23	43

Product Details

Wavin OsmaWeld – ABS Solvent Weld waste

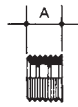

Reducer

- 32 Reducer to 21.5mm pipe
- 40 Reducer to 35mm copper pipe
- 50 Reducer to 32mm pipe
- 50 Reducer to 42mm copper pipe

Material: Rubber

Nominal Size (mm)	Part Number	Colour Option	Dimensions (mm)
			A
32x21.5	4Z343	●	28
40x35	5Z344	●	38
50x32	2Z347	●	44
50x42	2Z349	●	44



Level Invert Reducer

- Reducer 40 to 32mm

Material: ABS

Nominal Size (mm)	Part Number	Colour Option		
		●	●	○
40x32	5Z085	●	●	○

Air Admittance Valve

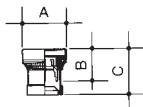

OsmaVent 40 Air Admittance Valve

- For direct connection to a 32mm [1¼"] or 40mm [1½"] waste spigot
- Allows air into discharge pipe systems without allowing foul air to escape
- See pages 99 and 100, BBA and BS EN 12056:2000 for ventilation requirements
- BBA certificated (Certificate No. 86/1643)

Material: ABS

Nominal Size (mm)	Part Number	Colour Option	Dimensions (mm)		
			A	B	C
40	4S303 ▲	○	66	40	71

Product Details

Wavin Osma Waste – Polypropylene push-fit waste

Pipe



Plain-Ended Pipe

Material: Polypropylene

Nominal Size (mm)	Part Number	Colour Option	Length (m)
32	4W073	● ● ○	3
40	5W073	● ● ○	3
50	2W073	● ○	3

Bracket

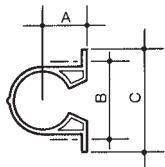

Pipe Bracket

- For support centres, see pages 10, 88 and 107

Material: Polypropylene

Nominal Size (mm)	Part Number	Colour Option	Dimensions (mm)		
			A	B	C
32	4W081	● ● ○	31	57	72
40	5W081	● ● ○	36	55	72
50	2W081	● ○	43	77	94

Socket

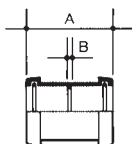

Double Socket

- For connecting lengths of polypropylene pipe
- Universal Connectors 4W102 and 5W102 should be used or connecting to other materials

Material: Polypropylene

Nominal Size (mm)	Part Number	Colour Option	Dimensions (mm)	
			A	B
32	4W105	● ● ○	68	2
40	5W105	● ● ○	79	2
50	2W105	● ○	71	2

Bends

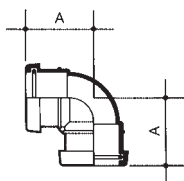

Knuckle Bend – 90°

Material: Polypropylene

Nominal Size (mm)	Part Number	Colour Option	Dimensions (mm)
			A
32	4W160	● ● ○	58
40	5W160	● ● ○	60
50	2W160	● ○	70

Product Details

Wavin Osma Waste – Polypropylene push-fit waste

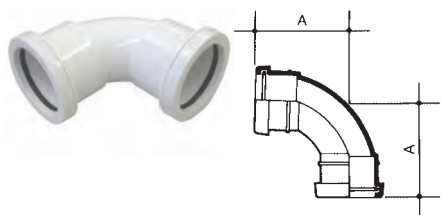

Bend – 87.5°

Material: Polypropylene

Nominal Size (mm)	Part Number	Colour Option	Dimensions (mm)	
			A	
32	4W161	● ● ○	62	
40	5W161	● ● ○	77	

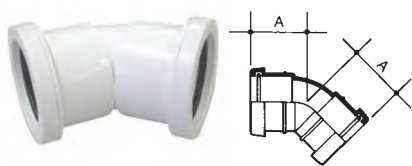

Bend – 45°

Material: Polypropylene

Nominal Size (mm)	Part Number	Colour Option	Dimensions (mm)	
			A	
32	4W163	● ● ○	48	
40	5W163	● ● ○	50	
50	2W163	● ○	49	



Spigot Bend – 30°

Material: Polypropylene

Nominal Size (mm)	Part Number	Colour Option	Dimensions (mm)	
			A	B
32	4W166	● ○	48	82
40	5W166	● ● ○	46	86

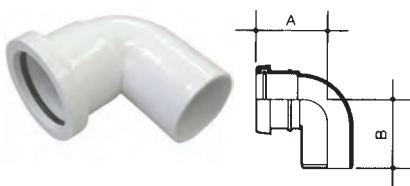

Spigot Bend – 90°

Material: Polypropylene

Nominal Size (mm)	Part Number	Colour Option	Dimensions (mm)	
			A	B
32	4W260	● ● ○	61	67
40	5W260	● ● ○	60	75
50	2W260	○	68	65

Tee

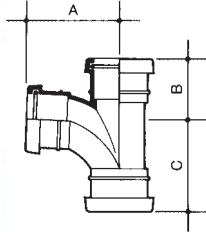

Tee – 87.5°

Material: Polypropylene

Nominal Size (mm)	Part Number	Colour Option	Dimensions (mm)		
			A	B	C
32	4W190 ▽	● ● ○	82	43	85
40	5W190 ▽	● ● ○	70	55	70
50	2W190 ▽	● ○	82	57	79

Plug

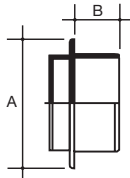

Access Plug

- Fits into a push-fit ring-seal socket to provide an access point
- See page 88 regarding provision of access

Material: Polypropylene

Nominal Size (mm)	Part Number	Colour Option	Dimensions (mm)	
			A	B
32	4W292 ▽	● ● ○	43	25
40	5W292 ▽	● ● ○	55	26
50	2W292 ▽	● ○	69	26

Connectors and Adaptors

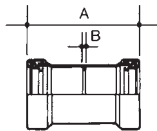

Universal Connector

- Two push-fit ring-seal sockets
- Connects to 32mm [1¼"] or 40mm [1½"] pipe to BS EN 1451-1/ BS EN 1455-1 and BS EN 1566-1
- Also connects to copper pipe to BS 659 and BS 2871

Material: Polypropylene

Nominal Size (mm)	Part Number	Colour Option	Dimensions (mm)	
			A	B
32	4W102 ▽	● ● ○	89	3
40	5W102 ▽	● ● ○	95	3
50	2W102 ▽	●	105	3

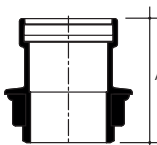

Tank Connector

- Push-fit socket connects to waste pipe to BS EN 1455-1/ BS EN 1451-1 and BS EN 1566-1
- Also connects to copper pipe to BS 659 and BS 2871

Material: Polypropylene

Nominal Size (mm)	Part Number	Colour Option	Dimensions (mm)
40	5W185 ▽	●	A 65

Product Details

Wavin Osma Waste – Polypropylene push-fit waste

Reducers

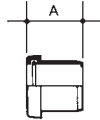

Reducer

- Spigot connects to 40mm [1½"] push-fit ring-seal socket to BS EN 1451-1
- Socket connects to 32mm [1¼"] waste pipe to BS EN 1451-1

Material: Polypropylene

Nominal Size (mm)	Part Number	Colour Option	Dimensions (mm) A
40x32	5W084	● ● ○	44

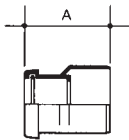

Level Invert Reducer

- Spigot connects to 50mm [2"] push-fit ring-seal socket to BS EN 1451-1
- Socket connects to 32mm [1¼"] or 40mm [1½"] waste pipe to BS EN 1451-1

Material: Polypropylene

Nominal Size (mm)	Part Number	Colour Option	Dimensions (mm) A
50x32	2W088	● ○	71
50x40	2W086	● ○	71

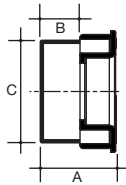

Waste to Overflow Reducer

- Fits inside a push-fit waste socket to BS EN 1451-1
- Allows connection of 21.5mm pipe

Material: ABS

Nominal Size (mm)	Part Number	Colour Option	Dimensions (mm)		
			A	B	C
32x21.5	1C344	○	26	16	34
40x21.5	1C346	○	39	16	40

Air Admittance Valve

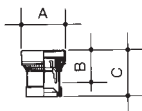

OsmaVent 40 Air Admittance Valve

- For direct connection to a 32mm [1¼"] or 40mm [1½"] waste spigot
- Allows air into discharge pipe systems without allowing foul air to escape
- See pages 99 and 100, BBA and BS EN 12056:2000 for ventilation requirements
- BBA certificated (Certificate No. 86/1643)

Material: ABS

Nominal Size (mm)	Part Number	Colour Option	Dimensions (mm)		
			A	B	C
40	4S303 ▲	○	66	40	71

Product Details

Wavin Osma Waste – Waste connectors & V-Joint traps

Flexible Waste Pipe



Flexible Spigot Connector

- Provided with a captive nut at one end and a 32mm [1¼"] or 40mm [1½"] spigot at the other

Material: Polypropylene

Nominal Size (mm)	Part Number	Colour Option	Length (mm)
32	4V901	○	450
40	5V901	○	450



Flexible Spigot Connector

- Provided with a captive nut at one end and a 32mm [1¼"] or 40mm [1½"] spigot at the other

Material: Polypropylene

Nominal Size (mm)	Part Number	Colour Option	Length (mm)
40	5V902	○	165-290

Bottle Traps

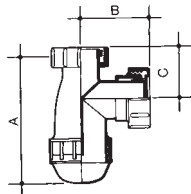

Bottle Trap – 38mm seal

- For use with appliances with trailing waste discharge, installed on ground floors and discharging to external gullies (refer to BS EN 12056:2000)

Material: Polypropylene

Nominal Size (mm)	Part Number	Colour Option	Dimensions (mm)		
			A	B	C
32	4V809	○	120	60	78
40	5V809	○	130	68	93

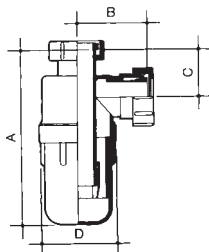

Bottle Trap – 75mm seal

Material: Polypropylene

Nominal Size (mm)	Part Number	Colour Option	Dimensions (mm)			
			A	B	C	D
32	4V812	○	172	72	47	66
40	5V812	○	175	76	50	74

Product Details

Wavin Osma Waste – Waste connectors & V-Joint traps

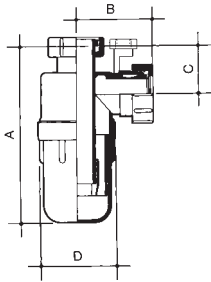

Anti-Syphon Bottle Trap – 75mm seal

- Designed to prevent loss of seal where either self-siphonage or induced siphonage is likely
- In some instances, can be used as an alternative to branch ventilation pipes (refer to BS EN 12056:2000)

Material: Polypropylene

Nominal Size (mm)	Part Number	Colour Option	Dimensions (mm)			
			A	B	C	D
32	4V814	○	172	72	48	62
40	5V814	○	190	80	50	72

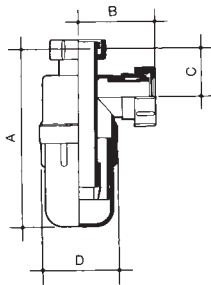

Re-Sealing Bottle Trap – 75mm seal

Material: Polypropylene

Nominal Size (mm)	Part Number	Colour Option	Dimensions (mm)			
			A	B	C	D
32	4V816	○	178	67	50	75
40	5V816	○	185	73	50	82

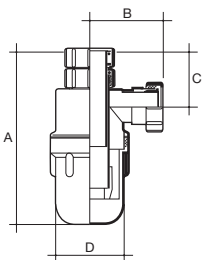

Adjustable Bottle Trap – 75mm seal

Material: Polypropylene

Nominal Size (mm)	Part Number	Colour Option	Dimensions (mm)				
			A min	A max	B	C	D
32	4V808	○	185	290	75	62	62
40	5V808	○	180	270	77	65	72

Tubular Traps

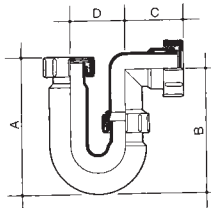

Tubular 'P' Trap – 75mm seal

Material: Polypropylene

Nominal Size (mm)	Part Number	Colour Option	Dimensions (mm)			
			A	B	C	D
32	4V801	○	145	120	57	57
40	5V801	○	150	138	60	63

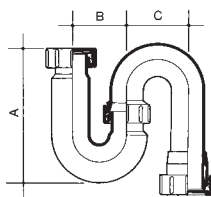

Tubular 'S' Trap – 75mm seal

Material: Polypropylene

Nominal Size (mm)	Part Number	Colour Option	Dimensions (mm)		
			A	B	C
32	4V803	○	145	57	57
40	5V803	○	150	63	63

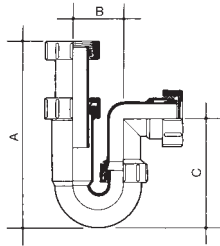

Adjustable Tubular 'P' Trap – 75mm seal

Material: Polypropylene

Nominal Size (mm)	Part Number	Colour Option	Dimensions (mm)			
			A min	A max	B	C
32	4V807	○	140	230	57	120
40	5V807	○	155	225	57	138

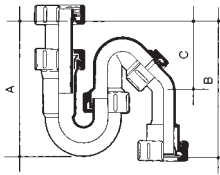

Variform Trap – 75mm seal

- Particularly useful for replacement, maintenance and improvement work where connection between two fixed points is required

Material: Polypropylene

Nominal Size (mm)	Part Number	Colour Option	Dimensions (mm)		
			A	B	C
32	4V804	○	146-224	155-211	56-134

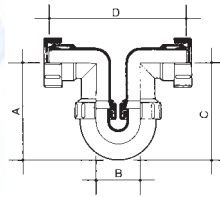

Running 'P' Trap – 75mm seal

- Both inlet and outlet incorporate 'V' joint connections

Material: Polypropylene

Nominal Size (mm)	Part Number	Colour Option	Dimensions (mm)			
			A	B	C	D
40	5V805	○	140	62	140	146

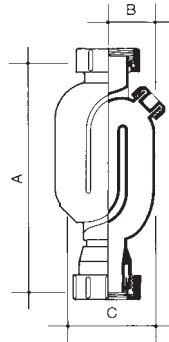

Straight Through Trap – 75mm seal

- Incorporates a cleaning eye
- Particularly useful for wash basin pedestals where the waste pipe can be concealed

Material: Polypropylene

Nominal Size (mm)	Part Number	Colour Option	Dimensions (mm)		
			A	B	C
32	4V825	○	240	44	88



Swivel 'P' Trap

Material: Polypropylene

Nominal Size (mm)	Part Number	Colour Option	Dimensions (mm)		
			A	B	C
32	4V811	○	-	-	-
40	5V811	○	105	75	140

Product Details

Wavin Osma Waste – Waste connectors & V-Joint traps

Bath Traps

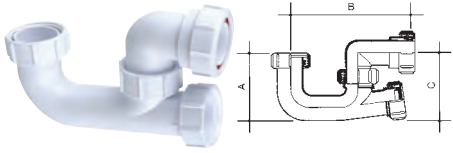

Bath Trap – 38mm seal

- For use with appliances trailing waste discharge and installed on ground floors discharging to an external gully
- Refer also to BS EN 12056:2000

Material: Polypropylene

Nominal Size (mm)	Part Number	Colour Option	Dimensions (mm)		
			A	B	C
40	5V802	○	85	170	95

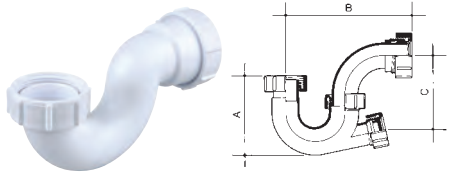

Bath Trap – Shallow seal

Material: Polypropylene

Nominal Size (mm)	Part Number	Colour Option	Dimensions (mm)		
			A	B	C
32	4V806	○	65	130	60
40	5V806	○	110	150	66

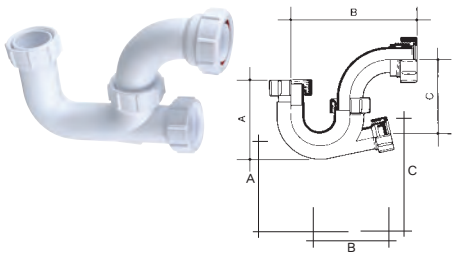

Bath Trap – 75mm seal

- Incorporates screwed access cover for maintenance

Material: Polypropylene

Nominal Size (mm)	Part Number	Colour Option	Dimensions (mm)		
			A	B	C
40	5V846	○	110	195	130

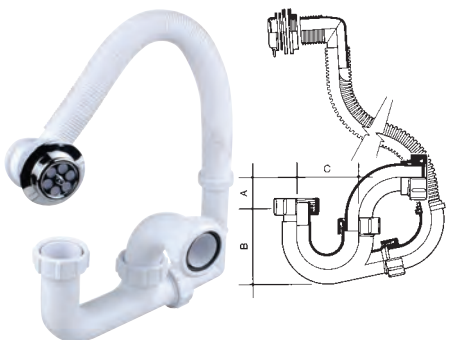

Bath Trap and Overflow – 75mm seal

- Incorporates:
flexible overflow connection
chromium-plated rose
chain for the waste plug

Material: Polypropylene

Nominal Size (mm)	Part Number	Colour Option	Dimensions (mm)		
			A	B	C
40	5V848	○	110	195	130

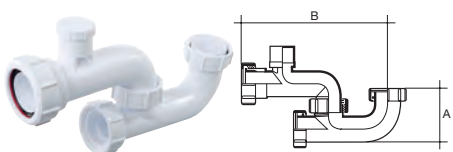

Anti-Syphon Bath Trap – 75mm seal

- 40mm Anti-Syphon Bath Trap with 50mm water seal

Material: Polypropylene

Nominal Size (mm)	Part Number	Colour Option	Dimensions (mm)	
			A	B
40	5V842	○	85	255

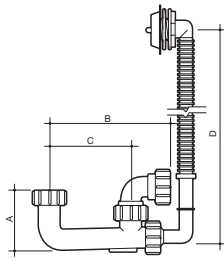

Bath Trap with Extended Body – 60mm seal

- Incorporates:
flexible overflow connection
chromium-plated rose
chain for the waste plug

Material: Polypropylene

Nominal Size (mm)	Part Number	Colour Option	Dimensions (mm)				
			A	B	C	D min	D max
40	5V860	○	85	210	150	300	500

Shower Traps

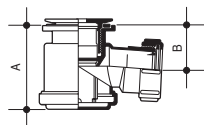

Shower Trap – 19mm seal

- Includes a dip tube, removable from top
- Allows for easy cleaning

Material: Polypropylene

Nominal Size (mm)	Part Number	Colour Option	Dimensions (mm)	
			A	B
40	5V823	○	90	42

Product Details

Wavin Osma Waste – Waste connectors & V-Joint traps

Shower and Floor Gullies

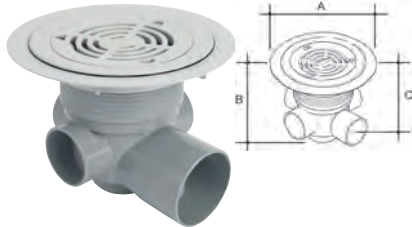

Vinyl Floor Gully

- Supplied with vinyl tile and grid
- 82mm outlet (solvent weld socket)
- 50mm depth water seal
- Three closed boss socket positions which can be drilled out with a 60mm hole saw
- Bosses to be used in conjunction with 2S498 (32mm), 2S499 (40mm) and 2S503 (50mm) rubber boss adaptors
- Spares and ancillary items available

Material: Body - PVC-U, Tile and Grid - Vinyl

Nominal Size (mm)	Part Number	Colour Option	Dimensions (mm)		
			A	B	C
82	2V411	●	242	183	120

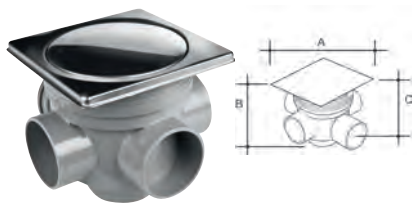

Floor Gully

- Supplied with stainless steel tile and grid
- 50mm outlet (push-fit socket)
- 50mm depth water seal
- Three closed boss socket positions which can be drilled out with a 60mm hole saw
- Bosses to be used in conjunction with 2S498 (32mm), 2S499 (40mm) and 2S503 (50mm) rubber boss adaptors
- Spares and ancillary items available

Material: Body - PVC-U, Tile and Grid - Stainless Steel

Nominal Size (mm)	Part Number	Colour Option	Dimensions (mm)		
			A	B	C
50	2V502	●	153	151	120

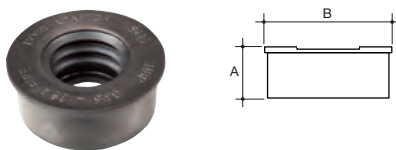

Rubber Boss Adaptor

- For use with floor gullies 2V411 and 2V502 (see above)

Material: Rubber

Nominal Size (mm)	Part Number	Colour Option	Dimensions (mm)	
			A	B
32	2S498 ♡	●	30	68
40	2S499 ♡	●	30	68
50	2S503 ♡	●	30	68



Stainless Steel Tile and Grid

Material: Stainless Steel

Nominal Size (mm)	Part Number	Colour Option
–	2V414	●



Gully Funnel Bowl

Material: Polypropylene

Nominal Size (mm)	Part Number	Colour Option
-	2V415	●



Gully Extension Bowl

Material: Polypropylene

Nominal Size (mm)	Part Number	Colour Option
-	2V416	●



Gully Funnel

Material: Polypropylene

Nominal Size (mm)	Part Number	Colour Option
-	2V418	●

Washing Machine Sink Traps

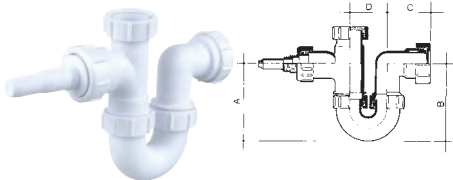

Washing Machine Half Trap – 75mm seal

- For direct connection to 3/4" hose from washing machines or dishwashers
- Hose adaptor can also be cut back to provide 3/4" or 1" BSPT male thread

Material: Polypropylene

Nominal Size (mm)	Part Number	Colour Option	Dimensions (mm)			
			A	B	C	D
40	5V864	○	185	140	60	63

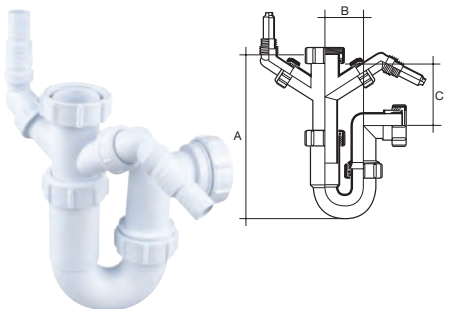

Adjustable Sink Trap – 75mm seal

- For direct connection of one or two 3/4" hoses from washing machines or dishwashers

Material: Polypropylene

Nominal Size (mm)	Part Number	Colour Option	Dimensions (mm)			
			A min	A max	B	C
40	5V869	○	195	260	63	65

Product Details

Wavin Osma Waste – Waste connectors & V-Joint traps

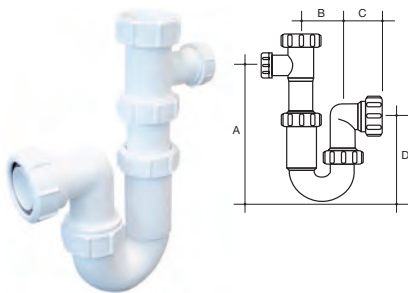

Tubular Swivel Trap

- 40mm x 75mm adjustable with 21.5mm connection

Material: Polypropylene

Nominal Size (mm)	Part Number	Colour Option	Dimensions (mm)			
			A	B	C	D
40	5V407	○	224	63	68	130

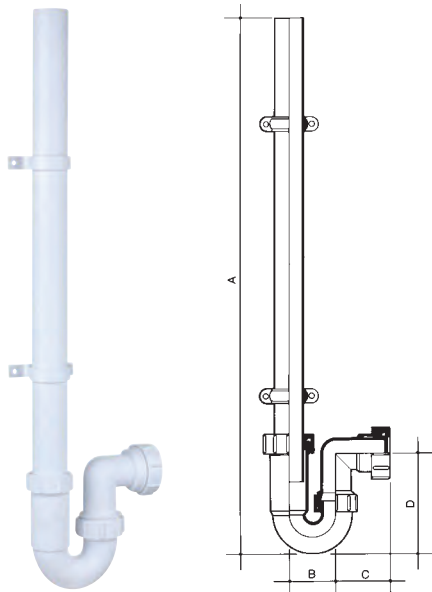

Washing Machine Trap with Standpipe – 75mm seal

- Machine hose hooks into top of standpipe to provide an air break
- Supplied with two pipe brackets

Material: Polypropylene

Nominal Size (mm)	Part Number	Colour Option	Dimensions (mm)			
			A	B	C	D
40	5V870	○	700	60	63	140

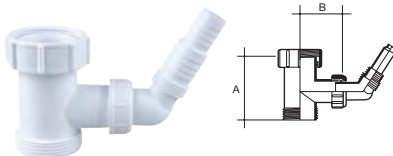

Washing Machine Tee Piece

- Fits between the sink and an existing trap
- Allows direct connection of a 3/4" hose from washing machines or dishwashers

Material: Polypropylene

Nominal Size (mm)	Part Number	Colour Option	Dimensions (mm)	
			A	B
40	5V871	○	70	54

Ancillaries

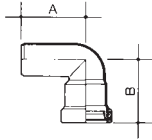

90° All-Fit Conversion Bend

- Converts a 'P' Trap Outlet to an 'S' Trap Outlet
- Connects to 32mm [1¼"] or 40mm [1½"] pipe to BS EN 1451-1/BS 5254 and BS 5255, or to copper pipe to BS 659 and BS 2871

Material: Polypropylene

Nominal Size (mm)	Part Number	Colour Option	Dimensions (mm)	
			A	B
32	4A830	○	69	67
40	5A830	○	71	71



Top Trap Washer

Material: Polypropylene

Nominal Size (mm)	Part Number
40	5V002

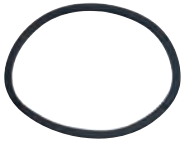

Bottle Trap Bowl Washer

- 4V003 for 4V809/4V812, 5V809/5V812

Material: Polypropylene

Nominal Size (mm)	Part Number
50	4V003

Product Details

Wavin Osma Waste – Condensate drainage

Soakaway

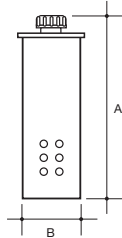

Soakaway

- 110mm OD with 21.5mm, 32mm, 40mm pipe connections

Material: Polypropylene

Nominal Size (mm)	Part Number	Colour Option	Dimensions (mm)	
			A	B
110	1V403	●	325	120

Connectors and adaptors



Overflow to Waste Clamp

- For connection to 32mm or 40mm
- Push-fit or Solvent Weld pipe

Material: Polypropylene

Nominal Size (mm)	Part Number	Colour Option
21.5	AO21	○

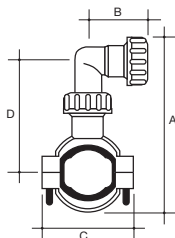

Pipe Clamp

- 32/40mm waste and 21.5mm connection

Material: Polypropylene

Nominal Size (mm)	Part Number	Colour Option	Dimensions (mm)			
			A	B	C	D
21.5	1V402	○	130	48	71	78

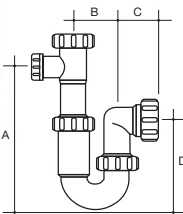

Tubular Swivel Trap

- 40mm x 75mm adjustable with 21.5mm connection

Material: Polypropylene

Nominal Size (mm)	Part Number	Colour Option	Dimensions (mm)			
			A	B	C	D
40	5V407	○	224	63	68	130

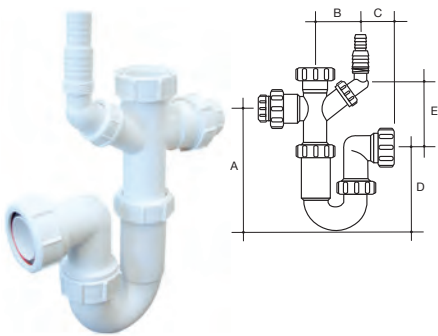

Tubular Swivel Trap

- 40mm x 75mm adjustable with 21.5mm connection and washing machine nozzle

Material: Polypropylene

Nominal Size (mm)	Part Number	Colour Option	Dimensions (mm)				
			A	B	C	D	E
40	5V468	○	188	130	61	130	90

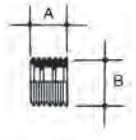

Reducer

- To 21.5mm pipe

Material: Synthetic rubber

Nominal Size (mm)	Part Number	Colour Option	Dimensions (mm)	
			A	B
32	4Z343	●	40	28

Product Details

Wavin Osma Waste – Solvent Weld overflow

Pipe



Plain-Ended Pipe

Material: PVC-U

Nominal Size (mm)	Part Number	Colour Option	Length (m)
21.5	1E073	○	3

Pipe Clip

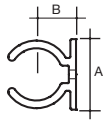

Pipe Clip

- For support centres, see pages 10, 88 and 107

Material: PVC-U

Nominal Size (mm)	Part Number	Colour Option	Dimensions (mm)	
			A	B
21.5	1E082	○	28	16

Socket

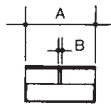

Double Socket

Material: ABS

Nominal Size (mm)	Part Number	Colour Option	Dimensions (mm)	
			A	B
21.5	1E104	○	53	2

Bends

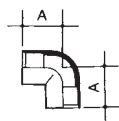

Bend – 90°

Material: ABS

Nominal Size (mm)	Part Number	Colour Option	Dimensions (mm)
			A
21.5	1E160	○	39

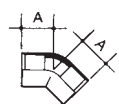

Bend – 45°

Material: ABS

Nominal Size (mm)	Part Number	Colour Option	Dimensions (mm)
			A
21.5	1E166	○	33

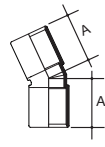

Bend – 25°

Material: ABS

Nominal Size (mm)	Part Number	Colour Option	Dimensions (mm)	
			A	
21.5	1E163	○	34	

Tee

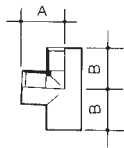

Tee – 90°

Material: ABS

Nominal Size (mm)	Part Number	Colour Option	Dimensions (mm)	
			A	B
21.5	1E190	○	39	39

Tank Connectors



Straight Tank Connector

- Flanged, threaded connector at one end, 21.5mm solvent weld socket at the other
- Includes two gaskets for connecting to tanks or cisterns

Material: ABS

Nominal Size (mm)	Part Number	Colour Option	Dimensions (mm)	
			A	
21.5	1E129	○	27	

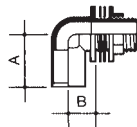

Bent Tank Connector – 90°

- Flanged, threaded connector at one end, 21.5mm solvent weld socket at the other
- Includes two gaskets for connecting to tanks or cisterns

Material: ABS

Nominal Size (mm)	Part Number	Colour Option	Dimensions (mm)	
			A	B
21.5	1E139	○	45	42

Product Details

Wavin Osma Waste – Solvent Weld overflow

Reducers

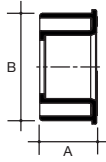

Waste to Overflow Reducer

- Fits inside a solvent weld waste socket to BS EN 1455-1 and BS EN 1566-1
- Allows connection of 21.5mm pipe

Material: ABS

Nominal Size (mm)	Part Number	Colour Option	Dimensions (mm)	
			A	B
32x21.5	1E344	●○	19	36
40x21.5	1E346	●○	23	43

Cap and Lining

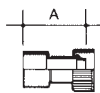

Cap and Lining

- Threaded nut connector at one end, 21.5mm solvent weld socket at the other
- The nut connects to 3/4" BSPT male thread

Material: ABS

Nominal Size (mm)	Part Number	Colour Option	Dimensions (mm)
			A
21.5	1E156	○	54

Adaptors



Compression Fitting Adaptor – Straight

- Spigot connects to compression fitting manufactured to BS 659, socket connects to 21.5mm [3/4"] PVC-U Solvent Weld Overflow Pipe
- Can also connect PVC-U Solvent Weld Overflow to WasteFlow Units 5V835, 5V837

Material: ABS

Nominal Size (mm)	Part Number	Colour Option	Dimensions (mm)
			A
21.5	1O158	○	30

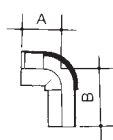

Compression Fitting Adaptor – 90°

- Spigot connects to compression fitting manufactured to BS 659, socket connects to 21.5mm [3/4"] PVC-U Solvent Weld Overflow Pipe
- Can also connect PVC-U Solvent Weld Overflow to WasteFlow Units 5V835, 5V837

Material: ABS

Nominal Size (mm)	Part Number	Colour Option	Dimensions (mm)	
			A	B
21.5	1O159	○	31	47

Product Details

Wavin Osma Waste – Polypropylene Push-fit overflow

Pipe



Plain-Ended Pipe

Material: Polypropylene

Nominal Size (mm)	Part Number	Colour Option	Length (m)
21.5	1C074	○	4

Pipe Clip

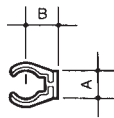

Pipe Clip

- For support centres, see pages 9, 89 and 108

Material: Polypropylene

Nominal Size (mm)	Part Number	Colour Option	Dimensions (mm)	
			A	B
21.5	1E082	○	28	16

Socket

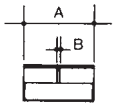

Double Socket

Material: Polypropylene

Nominal Size (mm)	Part Number	Colour Option	Dimensions (mm)	
			A	B
21.5	1C104	○	51	3

Bends

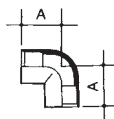

Bend – 90°

Material: Polypropylene

Nominal Size (mm)	Part Number	Colour Option	Dimensions (mm)
			A
21.5	1C160	○	37

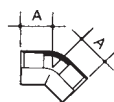

Bend – 45°

Material: Polypropylene

Nominal Size (mm)	Part Number	Colour Option	Dimensions (mm)
			A
21.5	1C163	○	35

Product Details

Wavin Osma Waste – Polypropylene Push-fit overflow

Tee

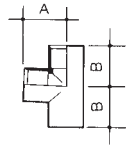

Tee – 90°

Material: Polypropylene

Nominal Size (mm)	Part Number	Colour Option	Dimensions (mm)	
			A	B
21.5	1C190	○	37	37

Tank Connector

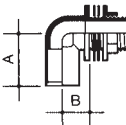

Bent Tank Connector – 90°

- Flanged, threaded connector at one end, 21.5mm push-fit socket at the other
- Includes two gaskets for connecting to tanks or cisterns
- Bend can be cut off to convert to straight tank connector

Material: Polypropylene

Nominal Size (mm)	Part Number	Colour Option	Dimensions (mm)	
			A	B
21.5	1C139	○	37	18

Reducer

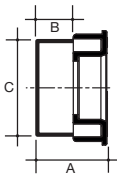

Waste to Overflow Reducer

- Fits inside a push-fit waste socket to BS EN 1451-1
- Allows connection of 21.5mm pipe

Material: ABS

Nominal Size (mm)	Part Number	Colour Option	Dimensions (mm)		
			A	B	C
32x21.5	1C344	○	26	16	34
40x21.5	1C346	○	39	16	40

Product Details

Wavin Osma HepvO – Hygienic self-sealing waste valve

HepvO Hygienic Self-Sealing Waste Valve

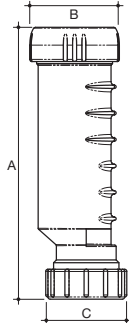

HepvO Valve

Material: Polypropylene

Nominal Size (mm)	Part Number	Colour Option	Dimensions (mm)		
			A	B	C
32	BV1 ♡	○	188	61	55
40	CV1 ♡	○	188	68	62

HepvO Knuckle Adaptor

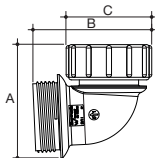

HepvO 87.5° Knuckle Adaptor

Material: Polypropylene

Nominal Size (mm)	Part Number	Colour Option	Dimensions (mm)		
			A	B	C
32	BV11 ♡	○	66	70	50
40	CV11 ♡	○	70	74	56

HepvO Running Adaptor

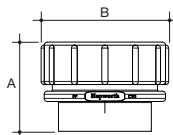

HepvO Running Adaptor

- For installing HepvO in a pipe run

Material: Polypropylene

Nominal Size (mm)	Part Number	Colour Option	Dimensions (mm)	
			A	B
32	BV3 ♡	○	43	55
40	CV3 ♡	○	43	62

HepvO Tundish Adaptor

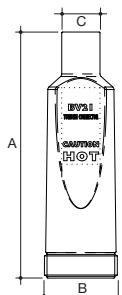

HepvO Tundish Adaptor Kit

Material: Polypropylene

Nominal Size (mm)	Part Number	Colour Option	Dimensions (mm)		
			A	B	C
32	BV1/21 ♡	○	142	22	15

For installation tips see:



Product Details

Wavin Osma – Problem solvers: flexible soil and waste

Flexible waste



Flexible Waste Pipe

- Smooth Bore – Use with Spigot connectors

Material: Polypropylene

Nominal Size (mm)	Part Number	Colour Option	Length (m)
32	FBP3	○	3
40	FCP3	○	3
32	FBP6	○	6
40	FCP6	○	6



Spigot Connectors

- To Push-fit Waste

Material: Polypropylene

Nominal Size (mm)	Part Number	Colour Option	Dimensions (mm)	
			A	B
40	FCW6	○	75	54



Spigot Connectors

- To Solvent Weld Waste

Material: ABS

Nominal Size (mm)	Part Number	Colour Option	Dimensions (mm)	
			A	B
32	FSBW6	○	62	46
40	FSCW6	○	75	54



Flexible Waste Connector

- Spigot : Spigot
- Fabricated length – To Push-fit Waste

Material: Polypropylene

Nominal Size (mm)	Part Number	Colour Option	Effective Length (mm)
40	FCW30	○	365



Flexible Waste Connector

- Spigot : Spigot
- Fabricated length – To Solvent Weld Waste

Material: Polypropylene

Nominal Size (mm)	Part Number	Colour Option	Effective Length (mm)
40	FSCW30	○	365

Flexible soil



Flexible Pan Connector – Long

- Nominal length 280mm, nominal extended length 920mm

Material: Polypropylene

Nominal Size (mm)	Part Number	Colour Option	Effective Length (mm)
110	S170	○	290-920 (extended)



Flexible Pan Connector – Short

- Nominal length 230mm, nominal extended length 670mm

Material: Polypropylene

Nominal Size (mm)	Part Number	Colour Option	Effective Length (mm)
110	S171	○	230-670 (extended)



Flexible Pan Connector – Extra Short

- Nominal length 195mm, nominal extended length 410mm

Material: Polypropylene

Nominal Size (mm)	Part Number	Colour Option	Effective Length (mm)
110	S172	○	195-410 (extended)

Product Details

Wavin Osma – Problem solvers: condensate

Condensate fittings



Condensate Soakaway

Material: Polypropylene

Nominal Size (mm)	Part Number	Colour Option
21.5	S951	●

Design Wavin Osma Soil and Waste

Typical Assembly

Figure 1: Typical stack assembly – Ring-Seal system

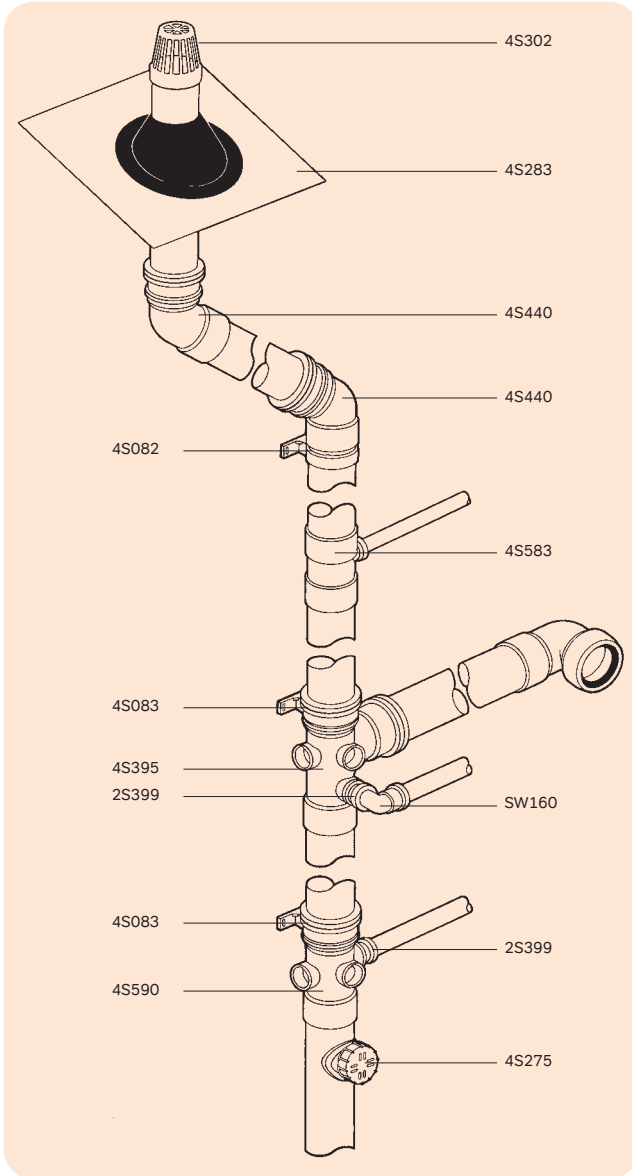
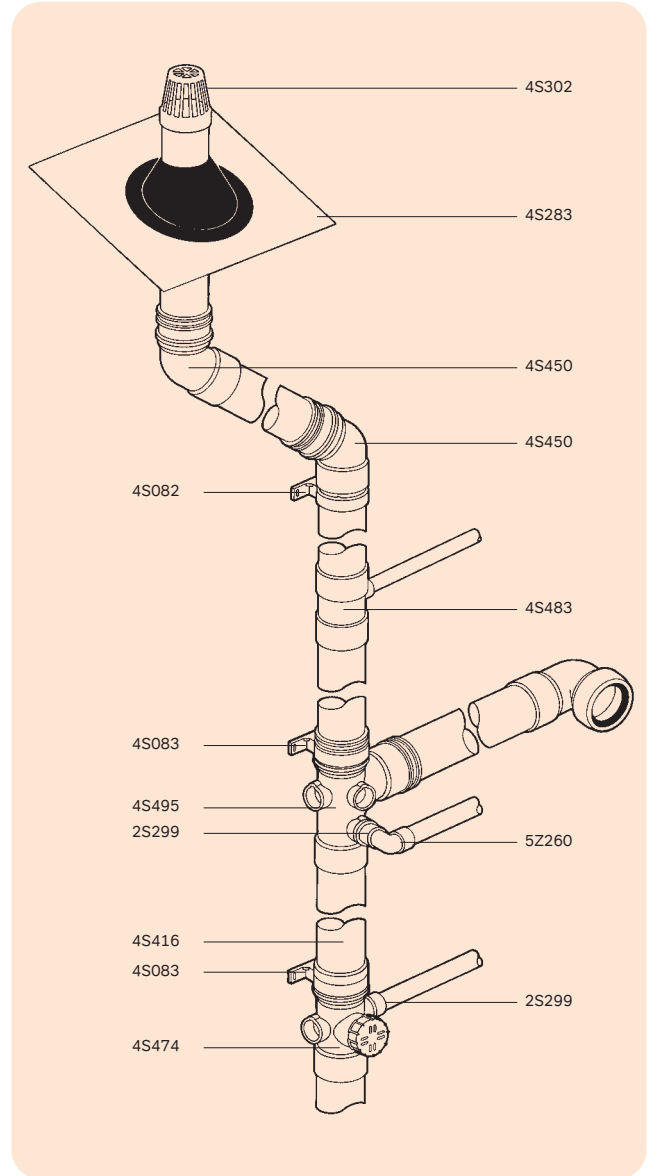

Figure 2: Typical stack assembly – Solvent Weld system



Design Wavin Osma Soil and Waste

Applications

General Principles

Wavin Osma Soil and Waste systems are designed to convey soil drainage and waste safely away from appliances to a soil stack or drain (see Figure 3). The systems are suitable for above ground sanitary fittings and appliances in domestic, commercial and public buildings. However, special requirements may apply to some trade wastes including:

- High temperature and chemical effluent
- Discharges from hospitals and laboratories

For maximum operating temperatures, see Materials: Properties and Performance, page 102.

Figure 3: Typical layout for Soil and Waste

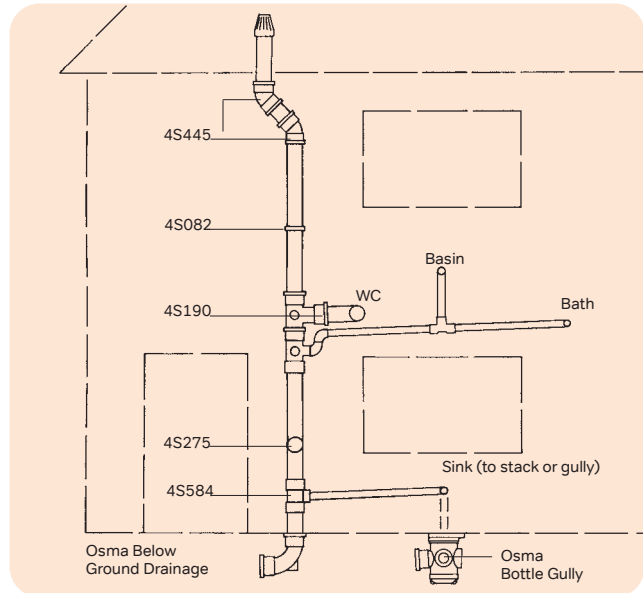

Pipe Sizing

Soil Systems

Stack

The internal diameter of a discharge stack should not be less than that of the largest trap or appliance discharging into it.

EXAMPLE: If a WC trap diameter is 110mm, the discharge stack must be minimum diameter 110mm.

Vent

Dry sections of vent pipe should typically have the same internal diameter as

the discharge stack. However, for 1- or 2-storey houses, the dry section may be 75mm diameter without affecting performance.

Waste Systems

The internal diameter of the waste pipe should not be less than that of the largest trap or appliance discharging into it. Minimum tubular trap sizes are given in Table 19 opposite.

Combined waste systems

Waste pipe diameters should be increased at the point where waste from two appliances meet (see Figure 4).

Table 19: Minimum Tubular Trap Sizes

Type of Appliances	Size of Trap
Wash Basin	32
Bidet	32
Sink	40
Bath	40
Shower	40
Urinal (bowl)	40
Urinal (slabs 1-7)	65
Washing Machine	40

Figure 4: Combined waste connection to soil stack

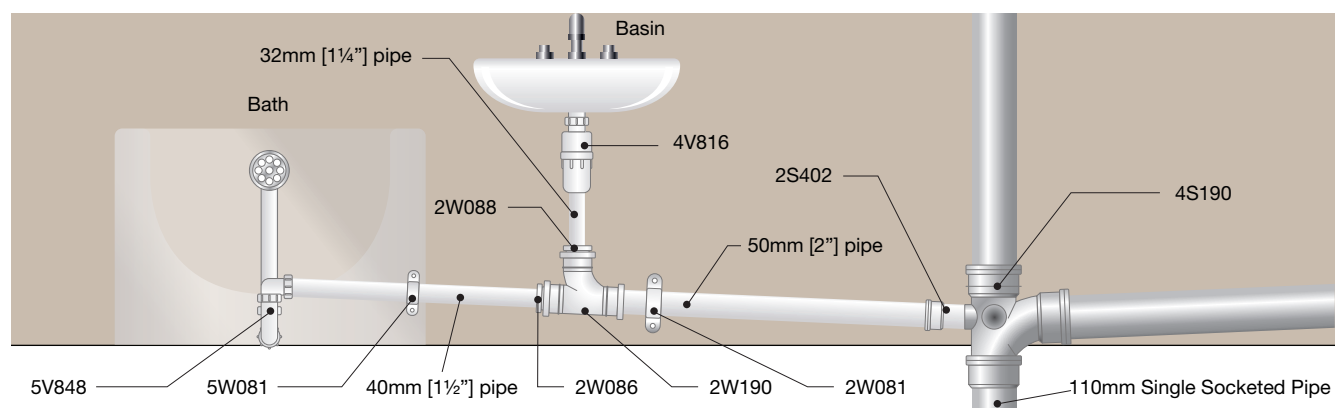

Maximum Pipe Runs

Waste Systems

The maximum recommended pipe run from trap to stack, serving single or combined appliances, is as follows:

- 3m for 40mm pipe
- 4m for 50mm pipe

Thermal Movement

Push-fit Systems

Correctly made and anchored ring-seal/push-fit joints will accommodate thermal movement with no requirement for expansion fittings. However 4S125 Acoustic socket can be used to accommodate expansion (without having to withdraw the pipe by 12mm) and prevent structure borne sound (see pages 104-105 for more details).

Solvent Weld Systems

Provision for thermal movement is required (see Figure 5):

- For all pipe runs over
 - 3m for 32, 40 or 50mm pipe
 - 4m for 82, 110 or 160mm pipe
- Between any two fixed points 1m or more apart

Fixed points include:

- Fittings supported by socket brackets
- Changes of direction
- Branches from other appliances

Pipe brackets allow the movement of pipework between fixed points whilst keeping the pipework steady.

The following components are available for the creation of thermal expansion joints:

Components

- PVC-U Solvent Weld Soil system:
 - Expansion Cap 4S416 (110mm) and 6S416 (160mm)
- PVC-U Push-fit Soil system:
 - Acoustic Socket 4S125 (110mm)
- ABS Solvent Weld Waste system:
 - Expansion Socket 4Z/5Z/2Z124

If the pipe run exceeds the recommended maximum lengths above, an increased risk of blockage and/or siphonage may occur:

- The pipe run must be vented to prevent self-siphonage or induced siphonage (See page 99 for details of use of Osma Air Admittance Valve 4S303)
- Access to be provided wherever possible
- Provision for thermal movement is required in the case of Solvent Weld systems (see below)

See pages 104-105 for using the 4S125 Acoustic Socket to accommodate thermal movement within a soil stack - and achieve maximum acoustic performance by preventing structure borne sound.

Figure 5: Thermal movement requirements for a Solvent Weld Soil system

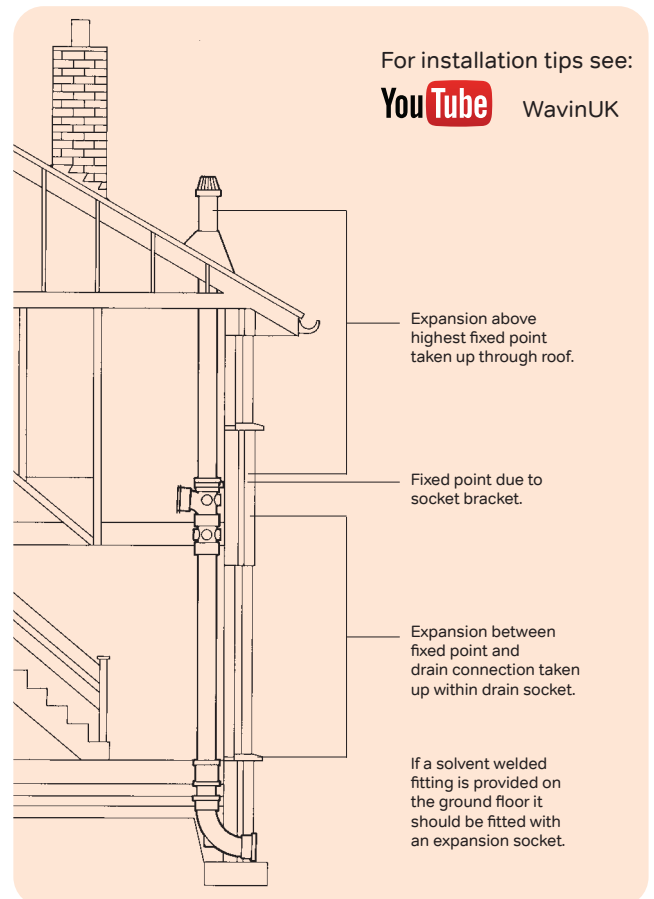

Design

Wavin Osma Soil and Waste

Pipe Support

Support Centres

Pipe should be supported in accordance with Table 20 below showing maximum support centres for pipes installed vertically and horizontally.

Brackets are available to meet all support requirements for Wavin Osma Soil and Waste systems.

Table 20: Maximum Pipe Support Centres

Pipe Size (mm)	Centres (m)	
	Vertical	Horizontal
21.5	0.5	0.5
32	1.2	0.5
40	1.2	0.5
50	1.2	0.6
82	2	1
110	2	1
160	2	1.2

Suspended Pipework

Bracket assemblies are available for suspended sanitary and drainage installations within a building.

The Suspended Bracketing system (see Figure 6) offers socket or pipe bracketing in 110mm and 160mm sizes and is adjustable to accommodate pipe falls. For installation details see page 107.

Note: Not suitable for use in damp inaccessible voids.

Figure 6: Suspended bracketing – socket support

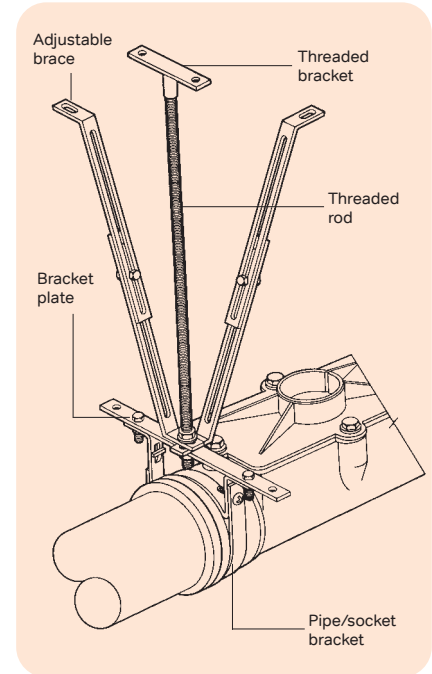

Access

Access points should be provided to enable all pipework to be tested and maintained effectively. To facilitate use of testing and cleaning equipment, access points should be positioned so that:

- Building structures such as walls and ducts do not impede use of the equipment
- No danger or nuisance is likely if leakage should occur

This can be achieved by positioning access points above the spill-over levels of any pipework which may be affected by blockages.

Access Fittings

A wide range of access fittings are available, including access pipes, bends and branches. See the Product Selector section for full details.

Access may also be created at an appropriate position in 110mm pipe by installing Access Saddle 4S275 (see Figure 7). This fitting can also be installed post construction. For installation details see page 109.

Access to Ranges of WCs

Branch pipes serving ranges of WCs should incorporate access points:

- At the head of the run
- Wherever the pipe changes direction

Venting of these branch pipes is not normally necessary, except:

- Where more than 8 WCs are being served
- Where there are several changes of direction

To increase self-cleansing, it is advisable for wash basins with resealing bottle traps to discharge into the waste system. See BS EN 12056:2000 for provision of access.

Figure 7: Access Saddle (4S275)

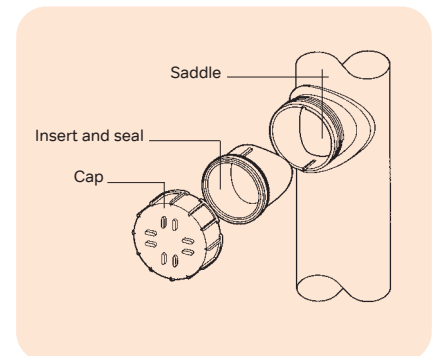

Urinals

Waste pipe serving urinals can be subject to build up of deposits, especially in areas of hard water:

- Make provision for access to all areas of the waste system
- Keep pipe runs as short as possible: less than 3m is recommended

Offsets

Offsets are permitted in the dry portion of the stack and do not require venting.

Offsets in the wet portion of a stack should ideally be avoided. Where this is unavoidable, use large radius bends.

A secondary ventilation stack may be necessary to connect above and below the offset, to reduce siphonage threat to traps.

The diameter of this ventilation stack pipework is typically half that of the discharge stack. (see Figure 8).

Figure 8: Ventilation stack to atmosphere

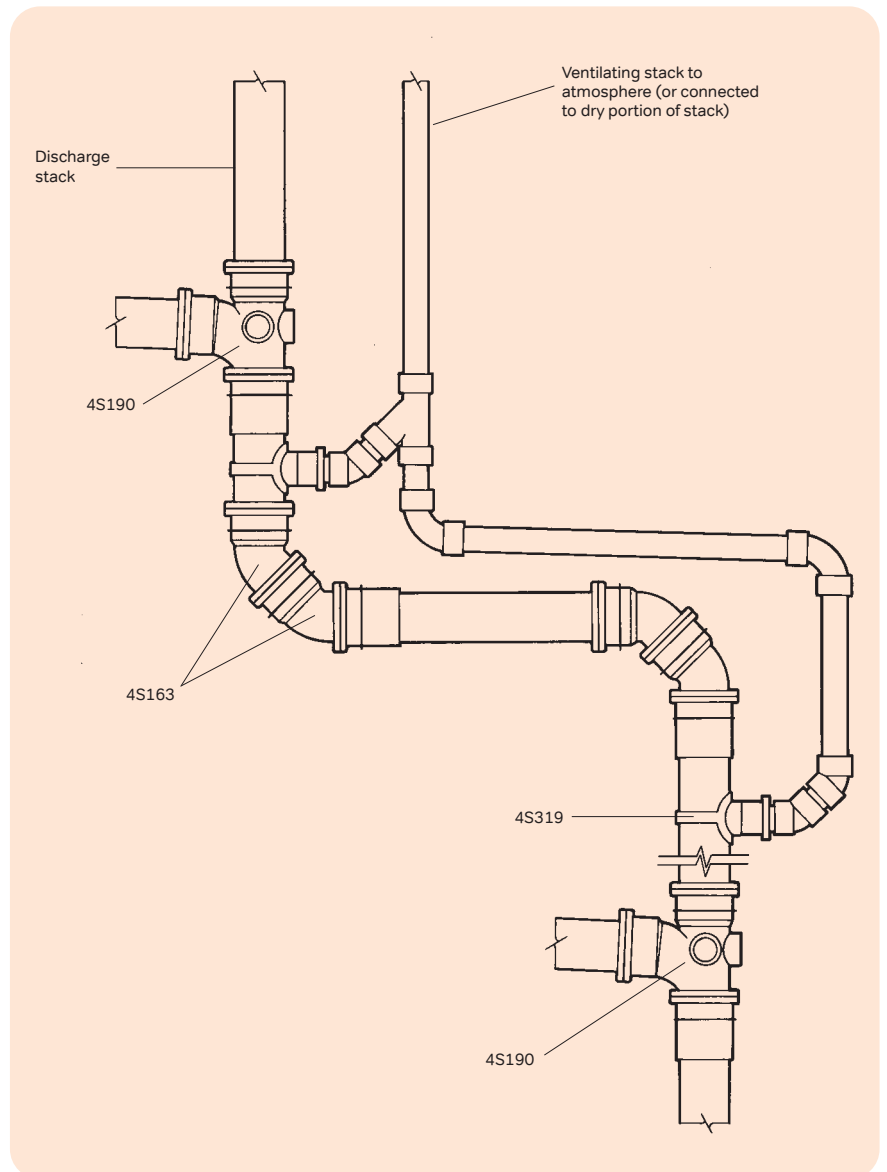

Design

Wavin Osma Soil and Waste

Connections to Drainage

Wavin Osma systems include couplers, connectors and adaptors to enable direct connection of Osma Above and Below Ground Drainage Pipes, and to other systems made of PVC-U, cast iron and clay.

Connections to PVC-U

110mm Osma Soil Pipe connections to PVC-U drainage pipes are straightforward using ring seal/push-fit Jointing and Osma Below Ground Drainage fittings.

- Via OsmaDrain Bend 4D581

Figure 9: PVC-U drain socket (via 4D581)

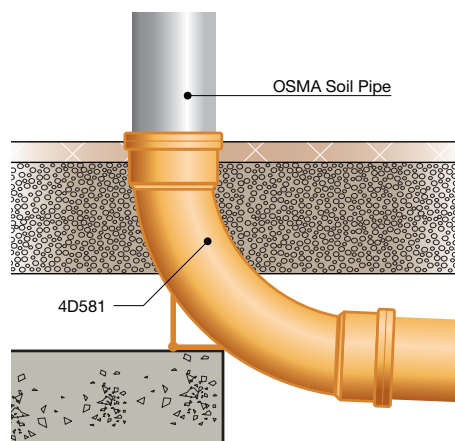

- Via OsmaDrain Coupler 4D205

Figure 10: PVC-U drain spigot (via 4D205)

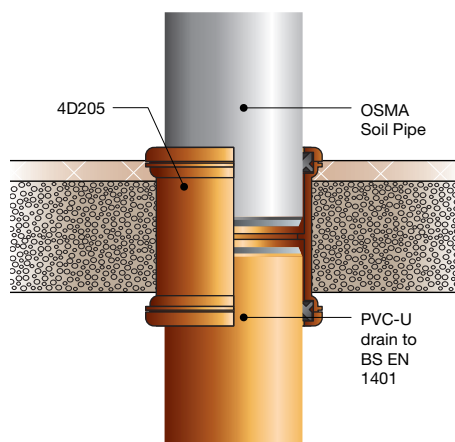

Connections to Other Materials

Osma Soil connections to non-plastic drainage materials include:

- To Clay
 - To thinwall clay drain pipe spigot via Adaptor 4D129
- To Cast Iron
 - To CI soil socket via Connector 4S106 OR Connector 4S206

For illustrations and detailed guidance on installation and connection procedures see page 108-19.

Waste to Drain Connections

Waste pipes can be connected to below ground drainage by using Boss Socket Adaptors. For typical arrangements see Figures 11-13.

Figure 11: Typical internal waste pipe connection to drain

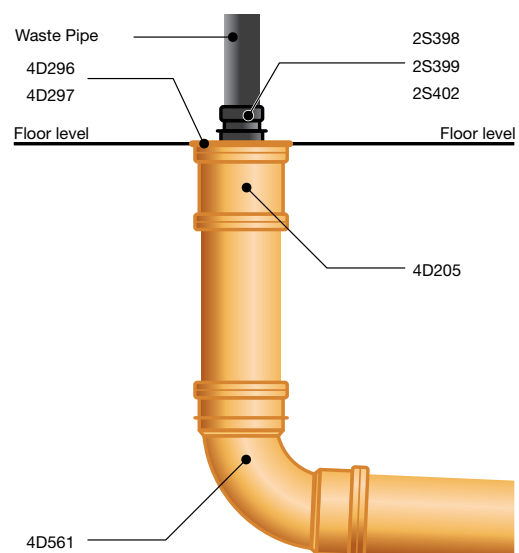

Figure 12: Typical waste connection to Sealed Hopper

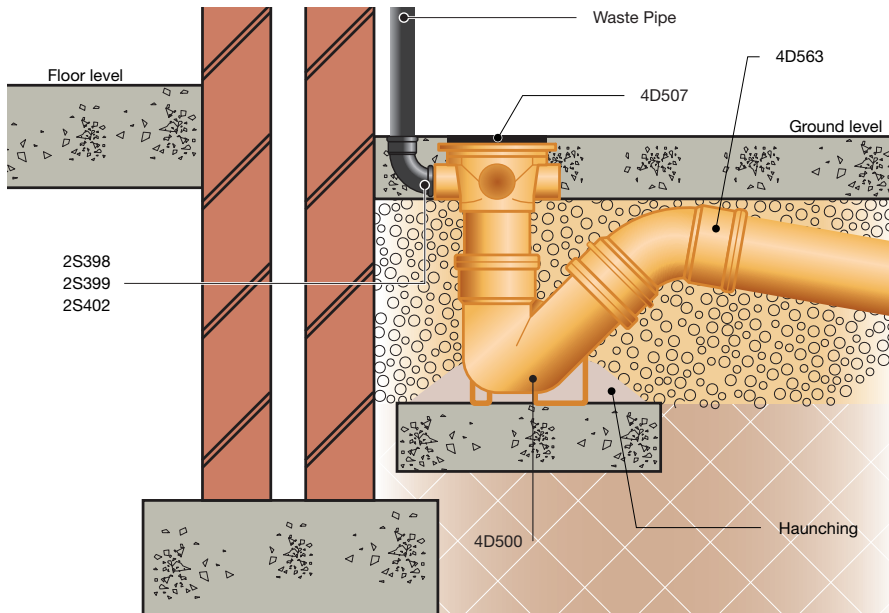
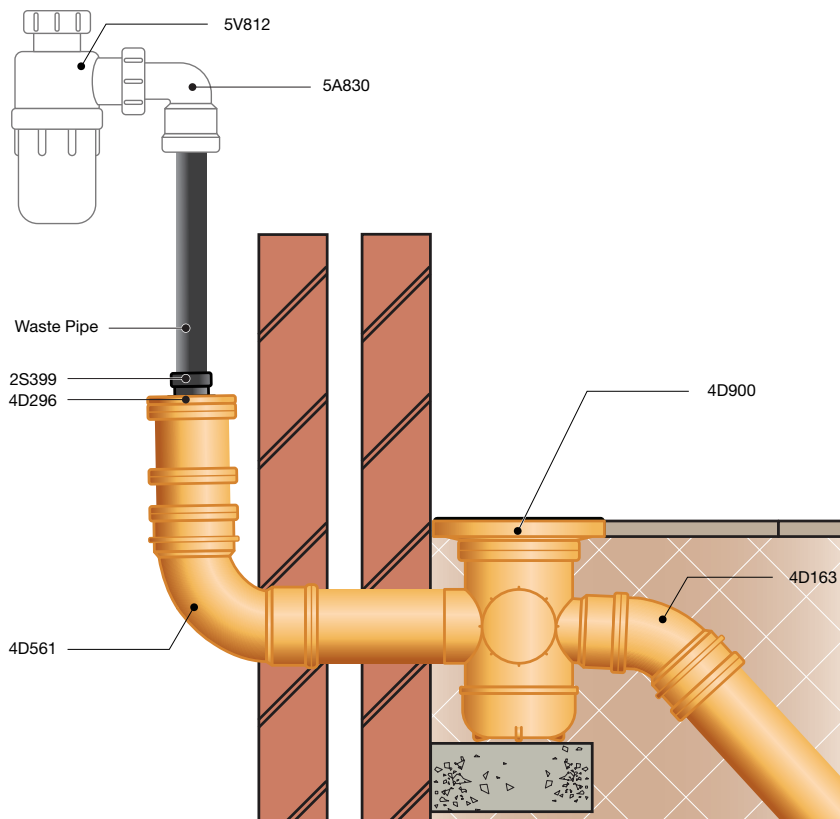

Figure 13: Typical waste pipe connection to Bottle Gully



Design Wavin Osma Soil and Waste

Connections to Waste

Bossed Fittings

Waste discharge pipework can be connected to the soil stack via a comprehensive range of Bossed Pipes and Bossed Branches, including:

- Single Bossed Pipes with one open boss socket
- Bossed Pipes with one open boss socket and three closed boss sockets
- Bossed Branches with up to five closed boss sockets (see Figure 14)

Discharge pipework feeding into the stack must be carefully designed to ensure safe flow and prevent cross flow. See Prevention of cross flow opposite.

Figure 14: Alternative Bossed Branches



Figure 15: Typical bathroom layout

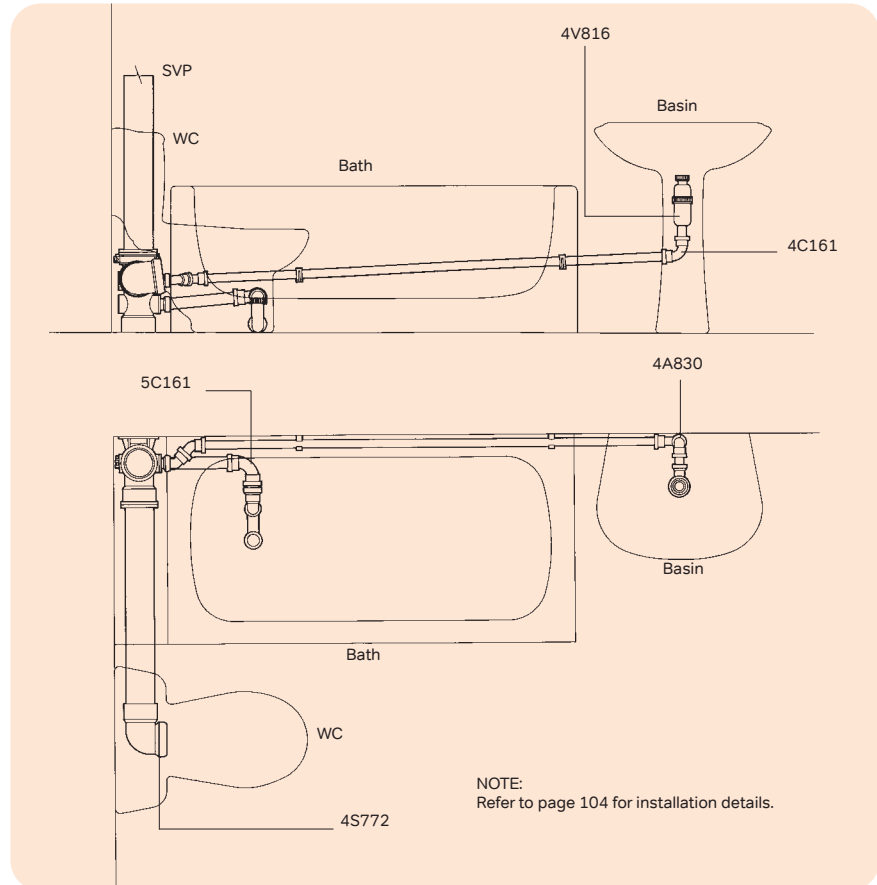

Boss Sockets

Closed boss sockets may be opened using a standard 50mm hole cutter. Boss Socket Adaptors are available with either push-fit sockets or solvent weld sockets:

- Push-fit: to enable connection to Polypropylene pipe manufactured to BS EN 1451-1, and copper waste pipes manufactured to BS 659 or BS 2871
- Solvent weld: to enable connection to ABS pipe manufactured to BS EN 1455-1 and PVC-C pipe manufactured to BS EN 1566-1

All horizontal Boss Socket Adaptors have an in-built fall of 2½° and a locating key at the top to ensure correct orientation.

Connections at Floor Level

The OsmaLink Soil Manifold 4S595 provides a simple method for connection of multiple waste pipes at floor level.

The system is particularly suitable for use in flats and other multi-storey developments (see Figure 16).

With a right-angled back and compact, unobtrusive design, the OsmaLink Soil Manifold fits neatly in any corner and permits simple push-fit waste connection via standard Adaptors 2S356/2S355/4Z124.

Its integral socket allows push-fit connection of a branch or soil pipe.

For installation details see page 111.

Connections at Floor Level

Figure 16: OsmaLink Soil Manifold system



- 6 boss connection points increasing the options for joining separate waste runs
- Low-level horizontal waste connection (allows plumber flexibility to achieve 132mm from centre line of horizontal branch inlet to invert of 50mm waste boss)
- Dual 40mm/50mm solvent weld connection
- Easy to drill waste connections – ample clearance from inner fitting section
- Reduced requirement for bends
- No special adaptors needed

Figure 17: 6 Boss Soil Manifold – 4S597

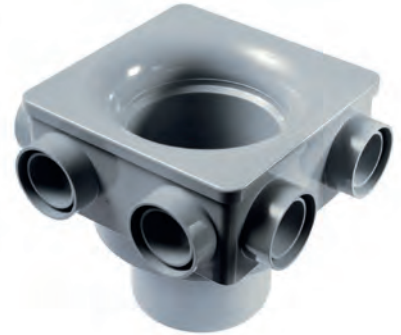
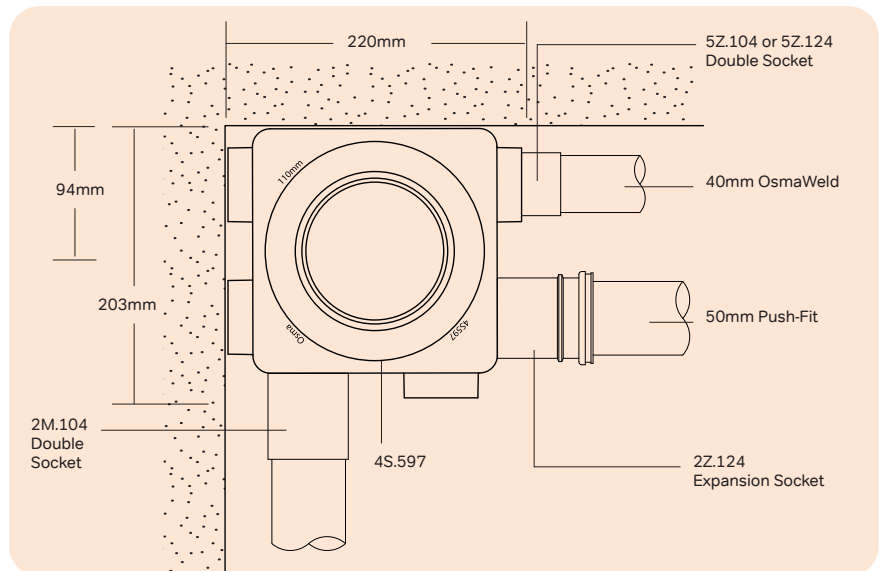

Figure 18: Typical Connections to 6 Boss Soil Manifold



The 6 Boss Soil Manifold – 4S597 is a compact fitting designed for easier installation where space is restricted. It is particularly suitable for multi-occupancy residential buildings.

- Horizontal waste connections: no upstanding bends required
- Compact 163mm square shaped body sits easily in 200mm drilled or formed hole
- Works equally well in corner or central locations

Figure 19: Typical Bathroom Installation using 6 Boss Soil Manifold 4S597

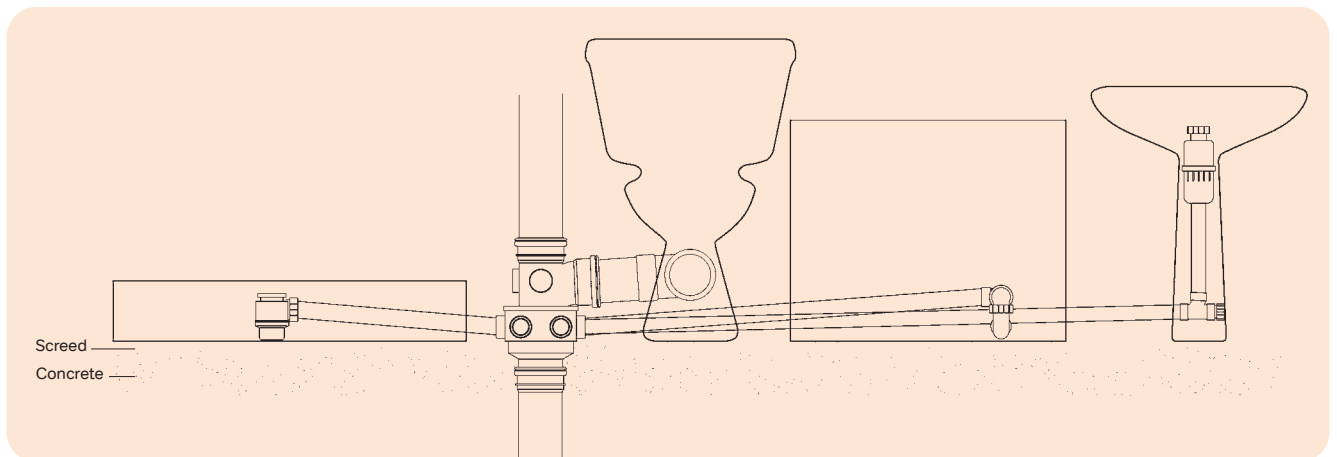

Design

Wavin Osma Soil and Waste

Connections – After Construction

Strap Bosses offer a low cost means of connecting waste pipes from basins, baths, bidets and showers to soil discharge pipework after construction. However, Strap Bosses are not recommended for use where high temperature discharges are likely (e.g. from kitchen sink wastes).

For installation details see page 110.

Permitted connections

Bossed Branches have a maximum of five socket positions. Two waste pipes may be connected to one side, or one waste pipe may be connected to each side, provided both connections are at the same level (see Figure 20).

Single connections are also possible at the side and rear of the Branch.

Connections NOT permitted

Offset connections to each side of the Branch are NOT permitted (see Figure 21).

Figure 20: Permitted connections

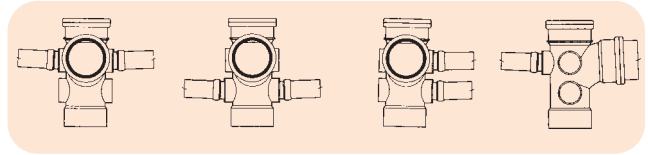
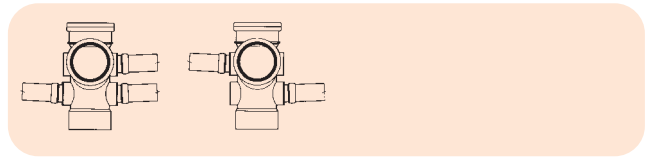

Figure 21: Connections NOT permitted



Prevention of Cross Flow

(see Figure 22)

Opposing connections to the stack are permitted provided that they are made:

- At the same centre line
- On or outside the edge of the connection zone created by any branch connection

See BS EN 12056:2000 for the prevention of cross flow.

Figure 22: Prevention of cross flow

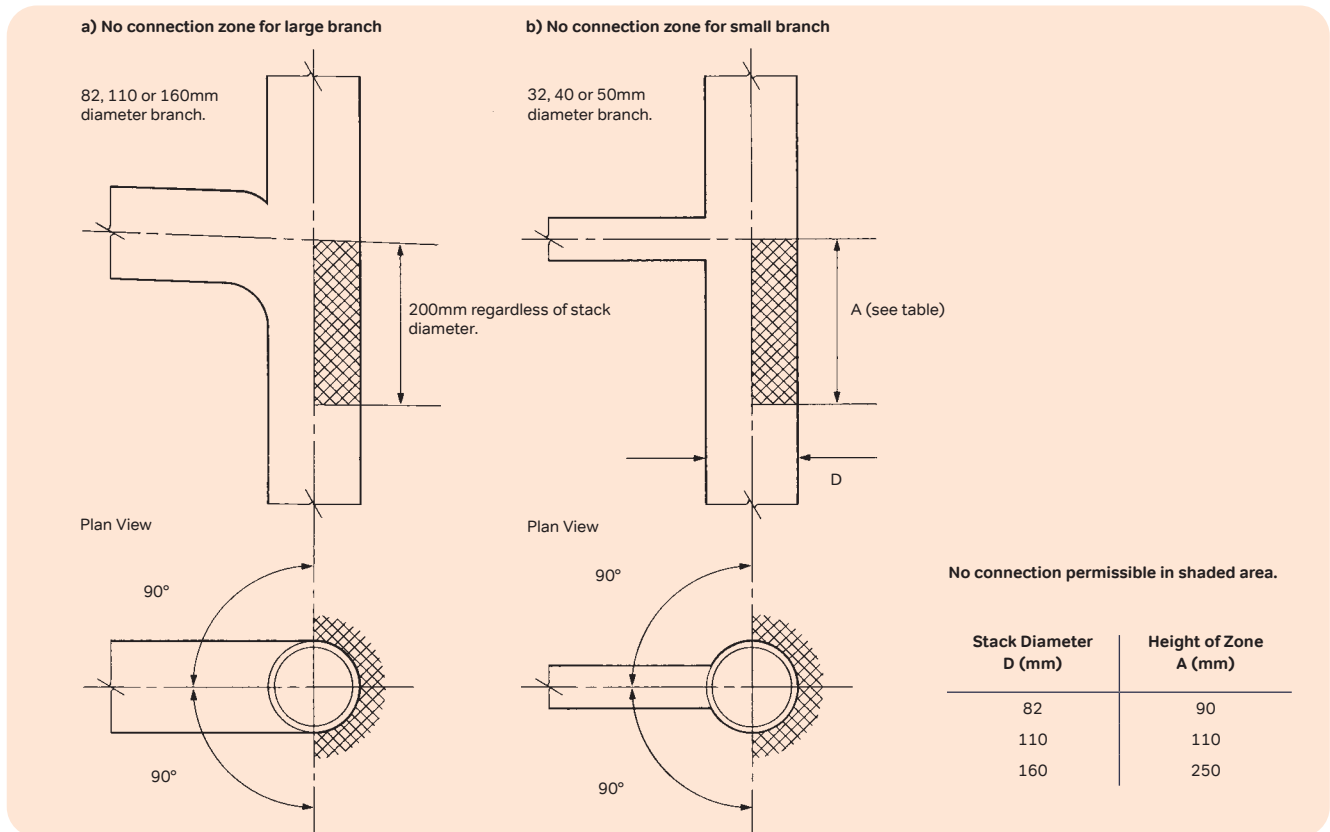

Design

Wavin Osma Soil and Waste

Connections to WCs

WCs Manufactured to BS 5503

Wavin OsmaSoil includes a wide range of white WC Connectors and bends for direct connection to WCs manufactured to BS 5503.

PVC-U 110mm Fittings

Available in 2½°, 14° and 90° angles, each fitting has:

- Integral EPDM gasket for push-fit connection to the WC outlet (see Figure 24)
- Plain end (spigot) or solvent socket for connection to soil pipe/drain

For extension of a connector to overcome varying distances between WC spigot outlet and soil pipe/drain, S/S Long Tail Bend 4S790 may be added and cut to length. NOT to be used as WC Connector alone (see Figure 25). 90° Connectors with access are also available for ground floor installations.

Easy-fit Pan Connectors 3½" and 4"

Available in straight, offset, 14° and 90° configurations, each fitting has:

- Integral EPDM gasket for push-fit connection to the WC outlet
- Integral EPDM seal for push-fit into 110mm plastic pipe, or 102mm cast iron pipe to BS 416 (see Figure 23)

WCs Manufactured to BS 1213

Connectors and bends are available for straight connection direct to WC outlets (manufactured to BS 1213) when fitted with WC Gaskets 4S121 (for 4-4½" WC spigot) or 4S120 (for 4½-4½" WC spigot).

Figure 23: Easy-Fit Pan Connector

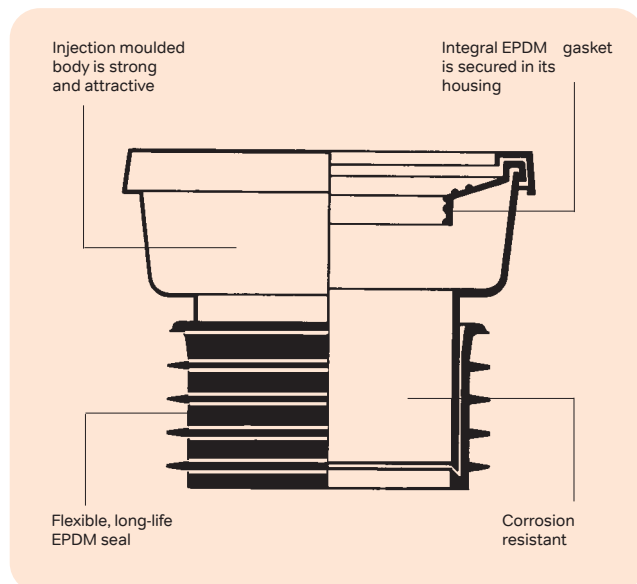

Figure 24: Connection to ground floor WC

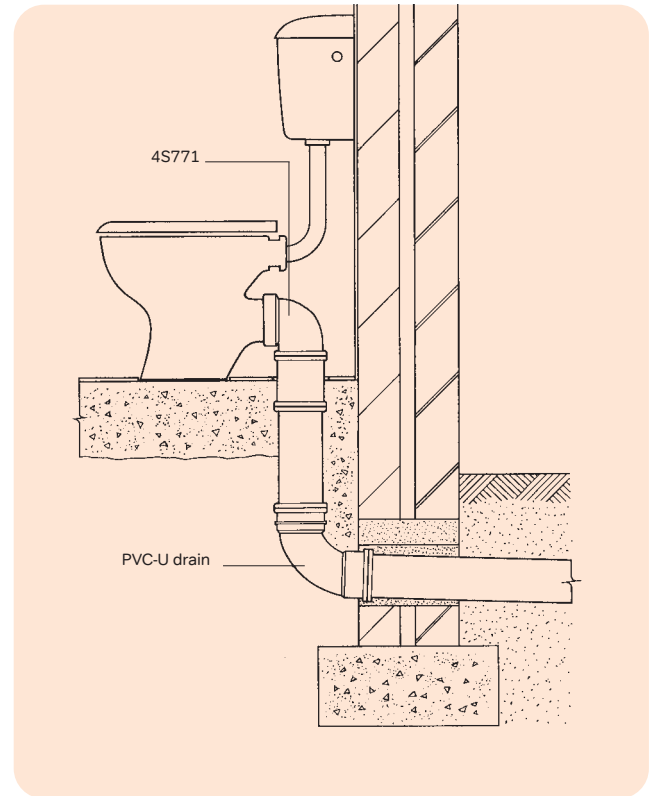
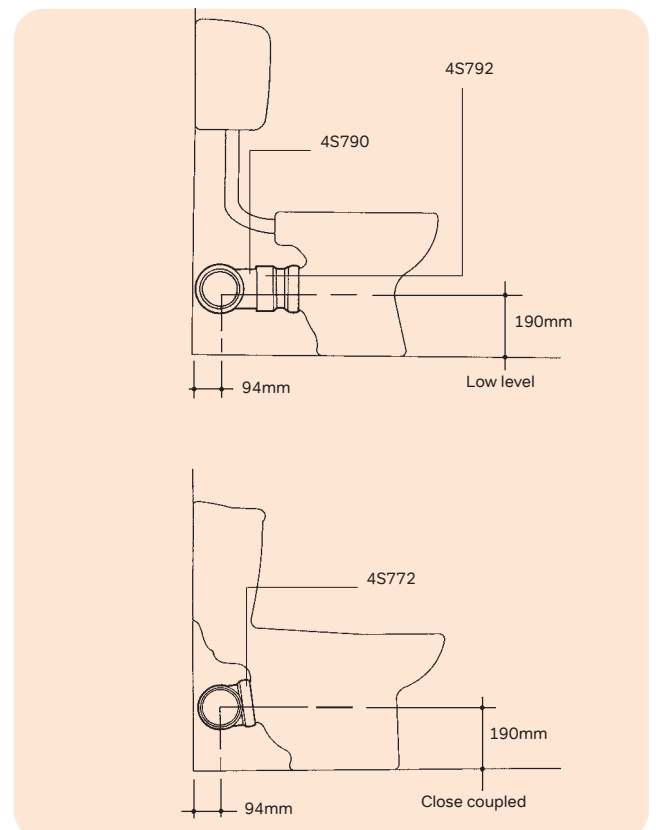

Figure 25: Alternative connection to WCs



Design

Wavin Osma Soil and Waste

WCs Back-to-back

Osma Corner Branch – 87½° 4S291/491 enables connection of back-to-back WCs to drain (see Figs. 26/27).

Figure 26: Back-to-back WC installation

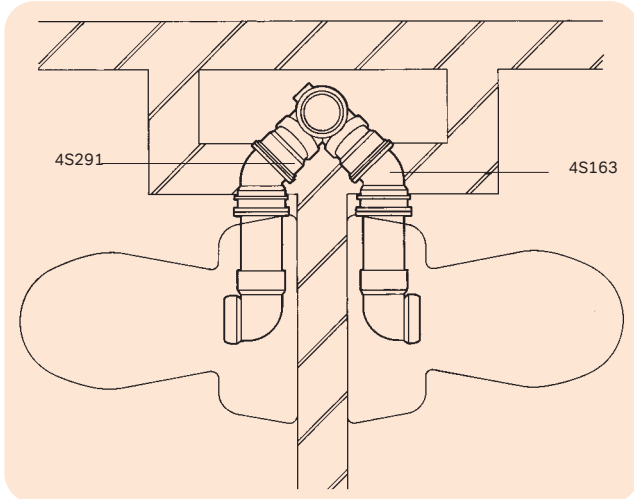
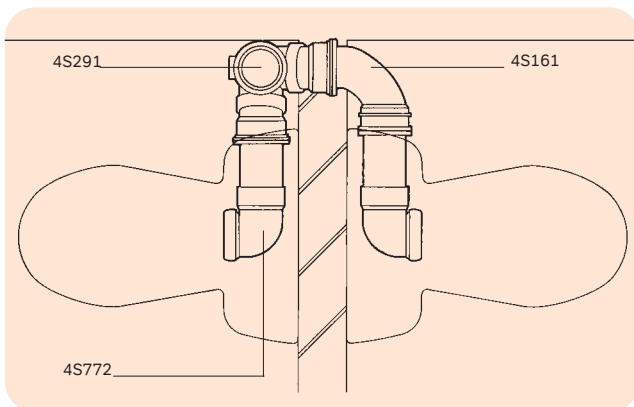

Figure 27: Alternative back-to-back WC installation



WC Connections Direct to Drainage

WCs may be connected direct to a drain. Venting will not be required provided that the distance from the crown of the trap to the invert of the drain does not exceed 1.5m (see Figure 24).

Stub Stacks

Designed as a 110mm discharge stack with access fitting cap on top. Connects various appliances to the drain or discharge stack, providing the total loading does not exceed 5 litres/sec.

The distance from the invert level of the drain or discharge pipe to the topmost waste connection should not exceed 2.5m.

The distance from invert level to centre line of the WC should not exceed 1.5m (see Figure 28)

Figure 28: Typical stub stack arrangement

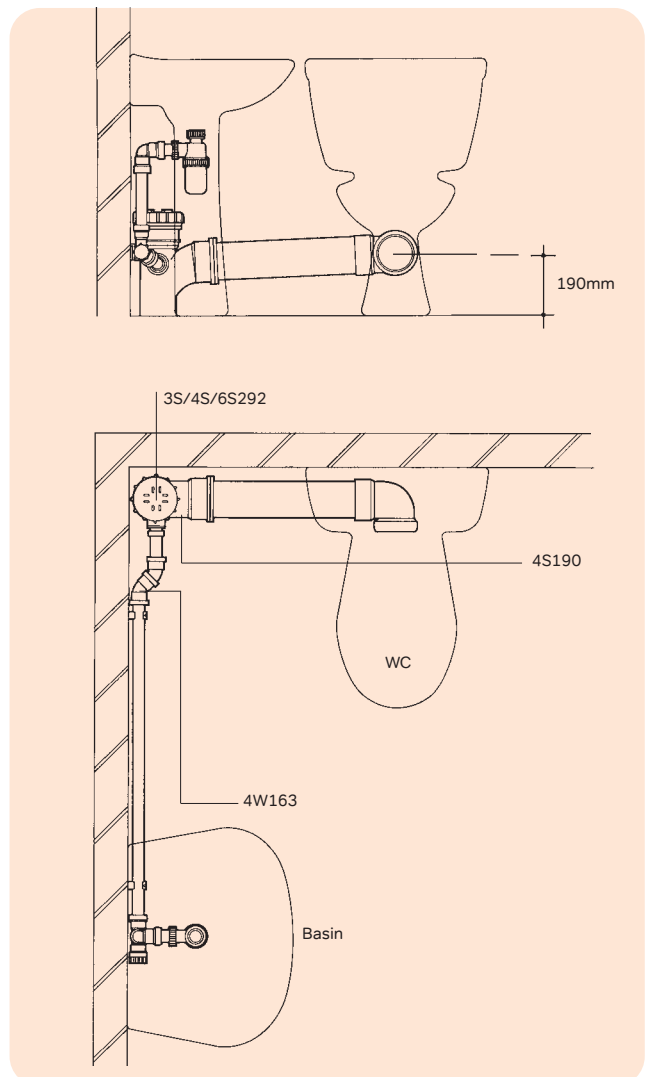

WC Manifolds

Connecting Multiple WCs

Osma Manifold Branches can be used to connect multiple WC outlets to a common soil discharge float leading to the soil and vent pipe (SVP). Up to 8 WCs (to BS 5503) can be connected, depending upon gradient.

The Manifold Branches are designed to be placed between the WC outlet and the wall behind it. As WC designs vary, this space should be checked to ensure there is sufficient room for manifold installation.

Eleven Manifold Branches include:

- 4S602 to 4S606: Five left-hand angled versions
- 4S612 to 4S616: Four right-hand angled versions
- 4S601: One straight Branch

The angled Branches are graduated from 8° to 38° in 7½° increments.

Each Branch, including the straight Branch, incorporates a WC Connector, with integral gasket, providing a minimum 2½° deflection all round.

BS EN 12056-2:2000 permits a float gradient will be between 0.5° and 5° (9 to 90mm per metre). The maximum available fall from the first WC (furthest from the SVP) to the last WC (nearest to the SVP) is 88mm (see Figure 29).

Planning Component Needs

Use the following procedure, in conjunction with the Graduated Scales Diagram (see Figure 31), to determine which Manifold Branches are required:

Procedure

1. Draw 1:50 scale plan of proposed WC positions.
2. Establish Left-hand or Right-hand orientation. Facing the WCs:
 - If the SVP will be at the Left end, use Section A of the Scales
 - If the SVP will be at the Right end, use Section B of the Scales.
3. Select the Scale for the required gradient of the float run.

4. Align arrowhead with first WC (furthest from SVP).
5. Provided all WCs fall within the Scale, proceed to Step 6. If not, select a shallower gradient and return to Step 4.
6. Note each part number where the centre line of the WC outlet concerned falls within a section.

NOTE: If the centre line of the WC outlet falls between two sections, either Manifold Branch is suitable. In some cases, with shallow gradients and close-set WCs, the same Manifold Branch will be appropriate (see example illustrated).

Figure 29: Left hand float for 8 WCs

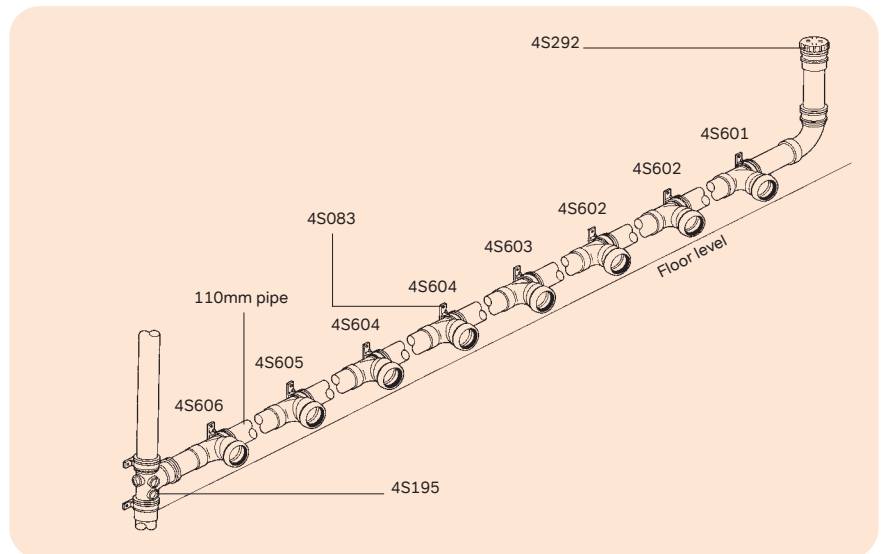
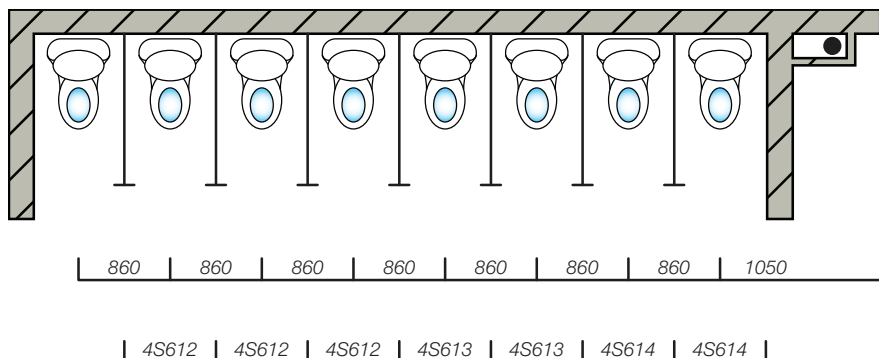
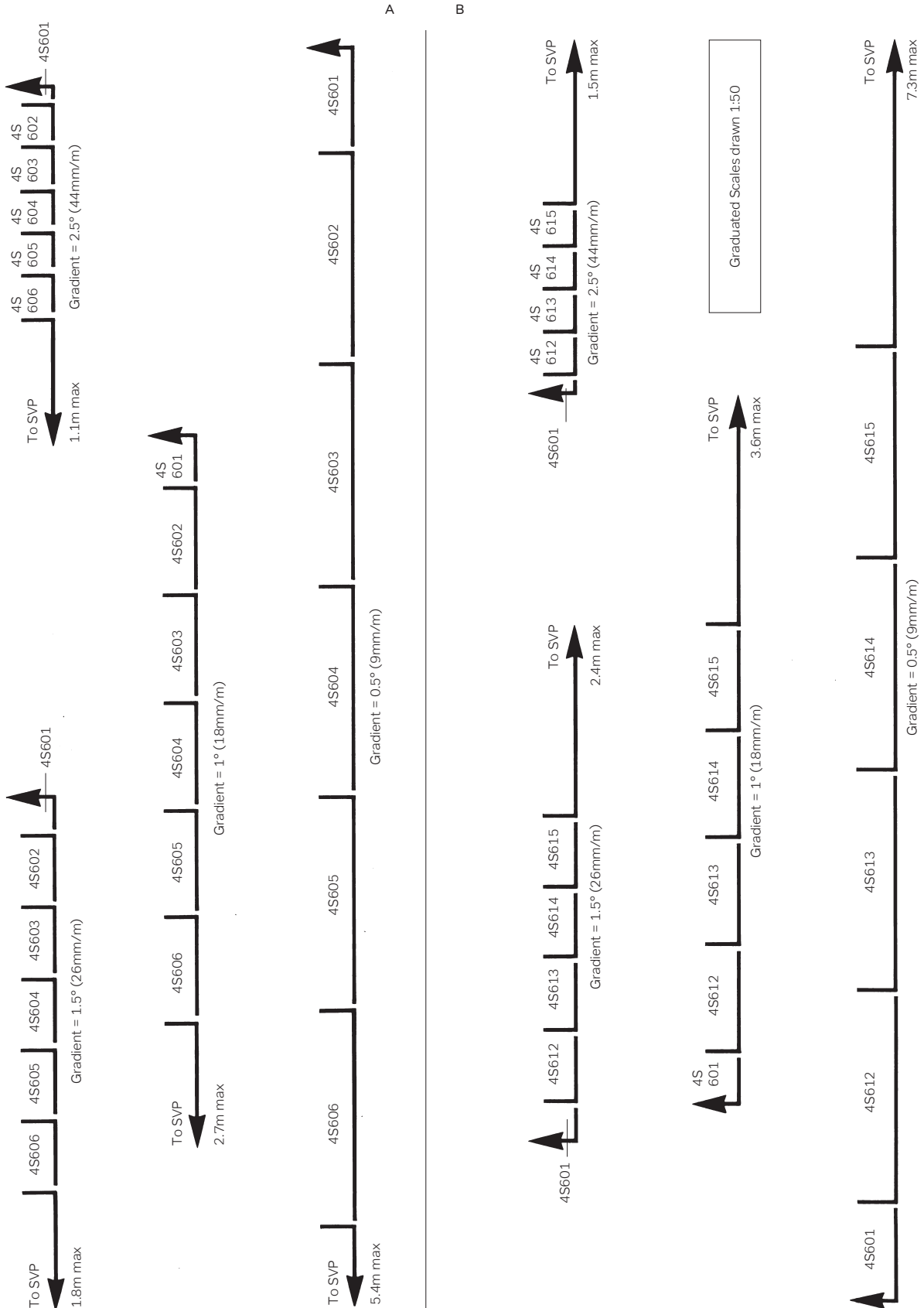

Figure 30: Typical layout of double manifold float



Design Wavin Osma Soil and Waste

Figure 31: Graduated Scales. NOTE must be used at 100% scale



Ventilation

General Principles

Discharge pipework must be vented to prevent self-siphonage or induced siphonage, and to protect traps.

Use of a separate ventilation stack to atmosphere is generally not required unless a sharp offset in the stack cannot be avoided (see also page 89).

Branch pipes

Separate ventilation of branch pipes is required only if the length and slope of the branch exceeds the dimensions set out in BS EN 12056:2000 or Part H of the Building Regulations (England and Wales), Part M (Scotland).

Air Admittance Valves

In many cases, and subject to certain design considerations, Osma Air Admittance Valves (AAVs) may be installed as an alternative to traditional venting techniques. These reduce the

number of ventilating pipes required to penetrate the roof in multi-installations, without affecting the performance of the drainage system.

AAV description and operation

Osma AAVs include a diaphragm which, in the closed position, seals the unit and prevents foul air from escaping. Whenever internal pressure drops, the higher pressure external air opens the diaphragm to admit air and equalise the internal/external air pressure (see Figure 32).

Soil Stack Ventilation

Osma A1 Rated 110mm Air Admittance Valve 4S304 is designed for venting of:

- 110mm soil stacks up to 10 storeys
- 110mm stub stacks

The 110mm AAV may be used on runs serving a row of 10 dwellings, provided the vent stack closest to the main sewer is vented traditionally to atmosphere.

See also Drain Ventilation overleaf.

When used to vent a soil stack, 110mm Air Admittance Valve 4S304 should be located:

- Within a building, fitted vertically
- Preferably in a non-habited space (duct or roof-space)
- Where there is no risk of freezing
- Where it is accessible but not at risk of interference by vandals
- Fitted 200mm above the highest branch

For full installation details see page 112.

NOTE: This should not be the only vent to a drainage system discharging to a septic tank or intercepting trap.

Osma A2 rated 110mm Air Admittance Valve 4S306 is designed for venting of:

- 110mm soil stacks up to 3 storeys
- 110mm stub stacks

The 110mm AAV may be used on runs serving a row of 10 dwellings, provided the vent stack closest to the main sewer is vented traditionally to atmosphere.

See also Drain Ventilation overleaf.

When used to vent a soil stack, 110mm Air Admittance Valve 4S306 should be located:

- Within a building, fitted vertically
- Preferably in a non-habited space (duct or roof-space)
- 150mm above the insulation in attic installations
- Where there is no risk of freezing
- Where it is accessible but not at risk of interference by vandals
- Installed above spillover level of highest appliance

Figure 32: Valve operation

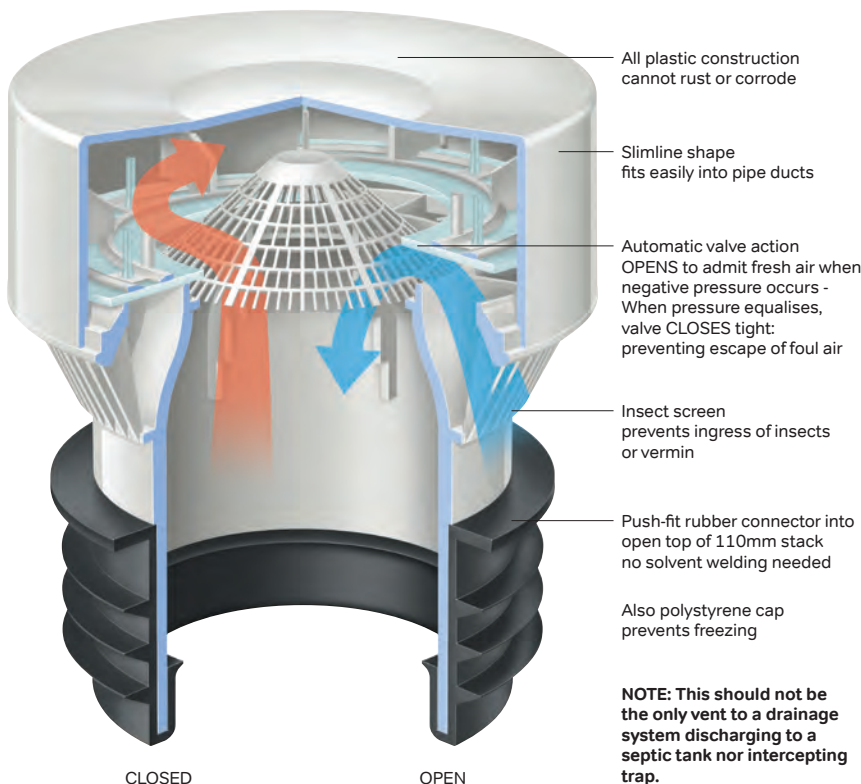

Design Wavin Osma Soil and Waste

Stub Stacks

When used to vent a stub stack, 110mm Air Admittance Valve 4S304 can be located 200mm above the highest branch. The Air Admittance Valve 4S306 must be installed above spillover level of highest appliance. (see Figure 33).

Waste Ventilation

40mm Air Admittance Valve 4S303 is designed for venting of 32, 40 or 50mm waste pipework where the pipe run exceeds the recommended maximum distance from the trap to the stack, i.e.:

- 3m for 40mm pipe
- 4m for 50mm pipe

The 40mm Air Admittance Valve 4S303 is suitable for use on single or combined waste systems. See page 112 for full installation details.

Drain Ventilation

110mm Air Admittance Valve 4S304 may also be used for drain ventilation.

Typical arrangements for access and provision of drain ventilation for different dwelling types are shown in Figure 34.

Radon Gas Resistance

Soil pipes and fittings are unaffected by radon gas when used as part of a ventilation system designed specifically for radon gas extraction. For connections made within a building, the use of solvent weld joints is advisable. For further information on radon gas, contact the BRE Radon Hotline on 01923 664707.

Figure 33: Vented stub stack

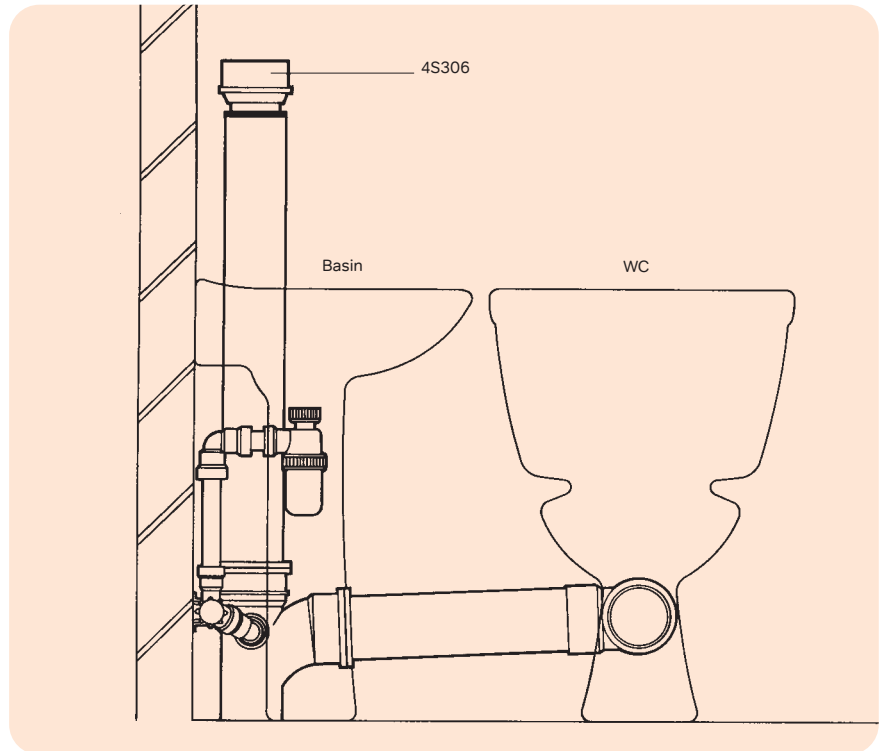
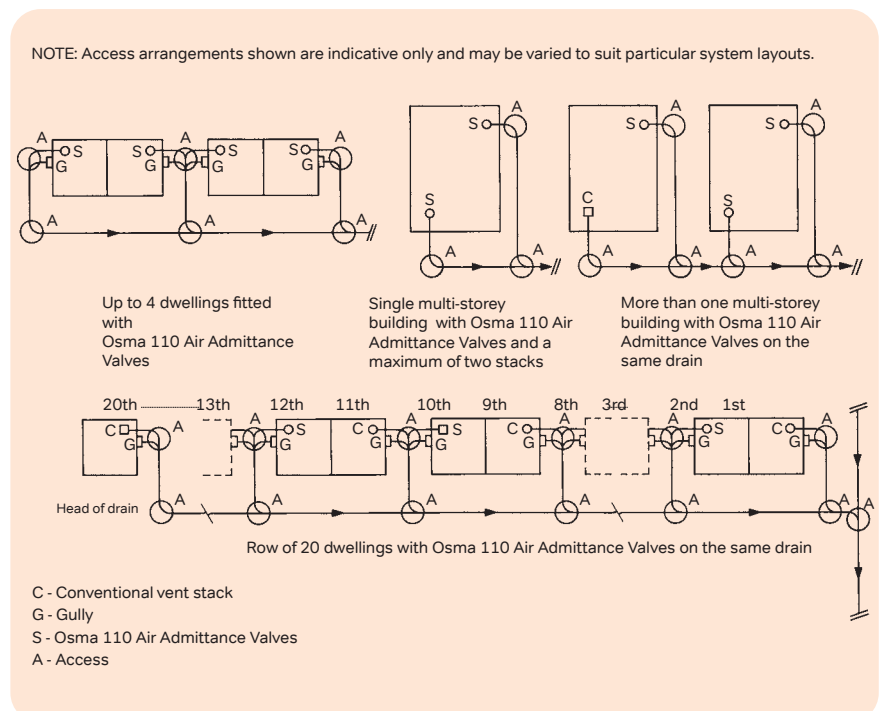

Figure 34: Examples of provisions for drain ventilation



Fire Stopping

Fire Stop Seals

Fire Stop Seals prevent the spread of fire, smoke and hot gases through plastic pipes that penetrate fire compartment floors and walls.

The Seals consist of two half shells of metal which are clipped around the pipe and anchored to the structure. The metal shell contains an intumescent material which reacts under intense heat.

Fire Stop Seals can be installed horizontally or vertically and provide an economic alternative to constructing fire resistant ducts.

Testing

Any fire stop seal used must be tested to the latest standards and comply with the requirements of Fire Safety Approved Document B.

Applications

Fire Stop Seals are suitable for maintaining the fire resistance of:

- Masonry walls and concrete floors which are penetrated by plastic pipework forming part of a drainage or ventilation system
- Timber floor constructions with ceiling lining which has at least one hour fire resistance rating

Fire Stop Seals can be fixed before or after the installation of the pipes and operate horizontally or vertically. For horizontal pipework where there is a fire risk from BOTH sides of the wall, the unit should be installed within the thickness of the wall or, if this is not possible, one unit should be fitted to each side of the wall (see Figure 37).

Fire Stop Seals are suitable for all types of new or refurbished buildings, especially residential flats, apartments, offices, hospitals, and schools.

They must be carefully fitted strictly in accordance with instructions. For full installation details, see manufacturers details.

Figure 37: Fixing positions for Fire Stop Seals in concrete floor/masonry wall

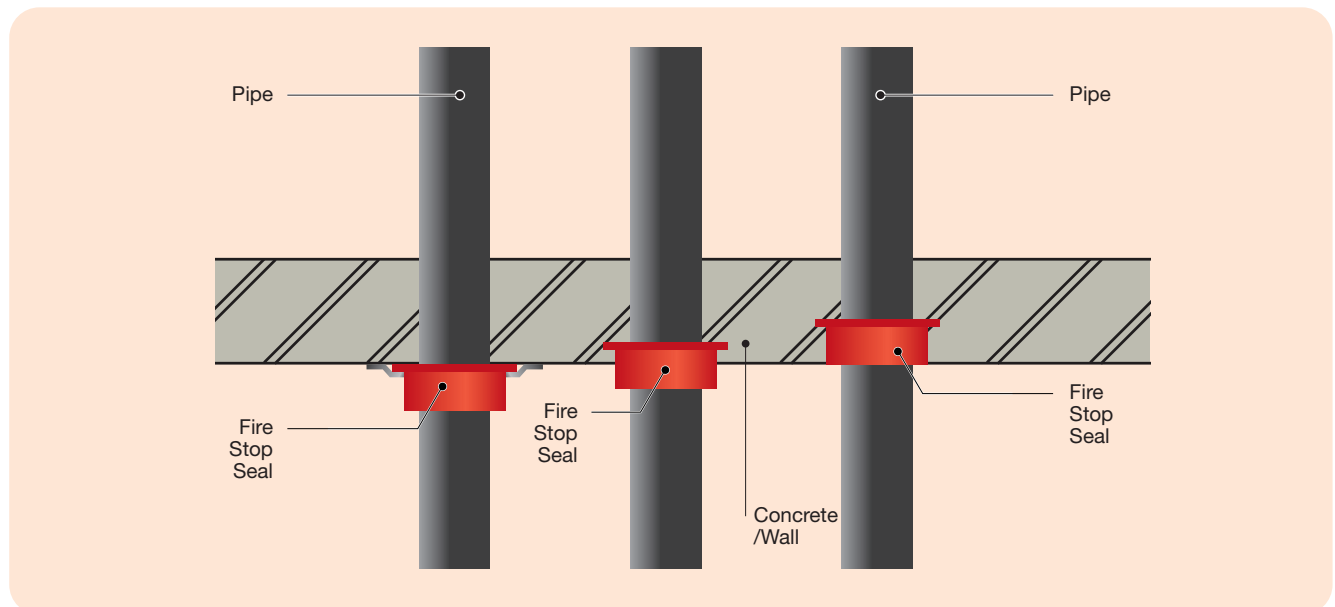

Design

Wavin Osma Soil and Waste

Materials: Properties and Performance

Heat Resistance

Pipes and fittings manufactured from PVC-U or ABS

- Wavin Osma Soil systems and ABS Solvent Weld Waste system – OsmaWeld: Suitable for use with intermittent discharges of water up to 90°C

Pipes and fittings manufactured from PVC-C or Polypropylene

- PP Push-Fit Waste systems (to BS EN 1451-1 and BS EN 1566-1) and V-Joint Traps: Suitable for use with intermittent discharges of water up to 100°C

PVC-U and ABS overflow pipes and fittings

- Solvent Weld Overflow system: Must not be used where hot water discharges are likely to occur

Polypropylene overflow pipes and fittings

- PP Push-Fit Overflow system: May be used where intermittent hot water discharges are likely to occur. However, they must not be used with combination hot water cylinders and feed tanks

Chemical Resistance

Osma Soil, Waste and Trap systems are unaffected by normal domestic effluent, detergents, cleaning fluids and a wide range of chemicals. Chemical effluent containing solvents should not be disposed of through PVC-U and ABS Waste systems.

For commercial and industrial applications, consult BSCP 312: Part 1: 1973 Code of Practice for plastic pipework. This provides comprehensive information on chemical resistance to plastic pipework.

Painting

Osma Soil, Waste and Overflow pipes and fittings are self-coloured and corrosion resistant. They may, however, be painted with normal household paints if an alternative colour is required. Oil-based gloss paint is the most suitable for this purpose. For best results, slightly abrade the surface with sandpaper and clean thoroughly before painting.

Timber Preservatives

If soil or waste pipes and fittings are to be installed externally and fixed to timber fascias or boards treated with timber preservatives, the preservatives must first be allowed to dry out prior to fitting. Refer to manufacturers' recommendations.

Biological Attack

Normal pollutants in the atmosphere will not affect Soil, Waste or Overflow systems. They are also unaffected by fungi, moss, lichen, moulds or bacteria.

Physical Attack

If pipework is installed internally or externally in areas likely to suffer attacks by vandals, the suitability of the material should be questioned. In such a situation, Solvent Weld systems are less likely to be dismantled than Ring-Seal or Push-Fit systems. However, unlike cast iron or copper systems, plastic has no scrap value and is therefore less likely to be targeted.

Ultra Violet Light

PVC-U pipework has superior resistance to the effects of UV light and, although it may fade slightly after many years of exposure to strong sunlight, its integrity is unaffected. It is recommended that externally installed ABS and PP pipework be painted with an oil-based gloss as a protective coating against long exposure to sunlight.

Radon Gas Resistance

Soil pipes and fittings are unaffected by radon gas when used as part of a ventilation system designed specifically for radon gas extraction. For connections made within a building, the use of solvent weld joints is advisable. For further information on radon gas, contact the BRE Radon Hotline on 01923 664707.

Handling, Storage and Safety

Handling

Care should be taken when handling pipe and fittings. Excessive scratching or scoring harms the appearance and can also affect the joint sealing.

Take extra care when handling pipe and fittings in wintry conditions. Cold weather reduces the impact strength of plastics. Use nylon belt slings, or forklifts with smooth forks, for mechanical unloading of block bundles. Metal slings, hooks or chains must not come into contact with pipes (see Figure 38).

Load and unload loose pipe by hand. Avoid using skids. When loose pipes have been transported one inside the other, always remove the inner pipe first.

Figure 38: Unloading of block bundles

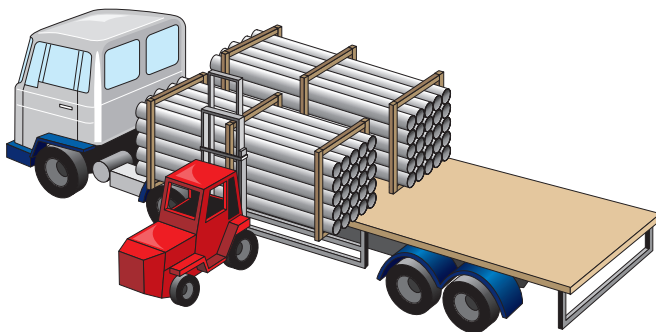

Storage

Always store pipe on a reasonably flat surface free from sharp projections.

Block Bundles

Block bundles can be stored up to 3m high without extra side supports or bearers. Block bundles will remain free-standing when cut. Take care when releasing bundles as the straps are under considerable tension and may flail when cut.

Loose Pipes

Loose pipe requires side supports at least every 2m. These supports should consist of battens at least 75mm wide. Ideally, support loose gutter or pipe uniformly throughout its entire length. If this is not possible, place timber supports at least 75mm wide at 1m maximum centres beneath the pipe (see Figure 40) Stack different size pipe separately, or, if not possible, stack with larger diameters at the bottom.

Maximum stack size: 7 layers or 2m high (see Figure 39).

Stack Socketed Pipe with sockets protruding and placed at alternate ends to ensure pipe is evenly supported.

Fittings

Store fittings supplied in plastic bags away from direct sunlight. If this is not possible, open bags to prevent a build-up of temperature.

Fittings in cardboard packaging (e.g. Fire Stop Seals and Air Admittance Valves) should be stored under cover until required.

Store degreasing cleaners, silicone lubricant, solvent cement and fillers in a cool place away from any heat source and out of direct sunlight.

Safety

The relevant regulations detailed in the Health and Safety at Work Act 1974 must be adhered to on site.

Figure 39: Storage of loose pipe on the ground

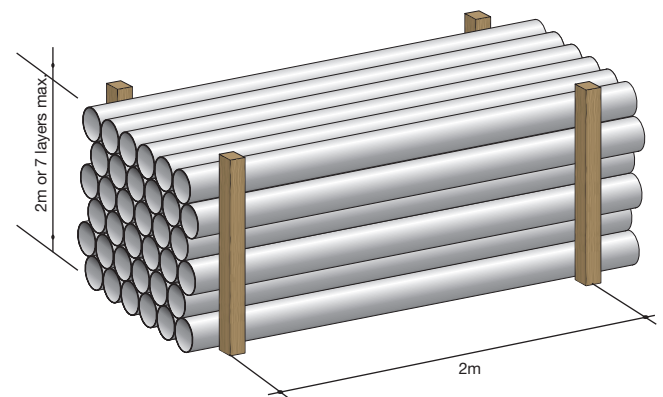
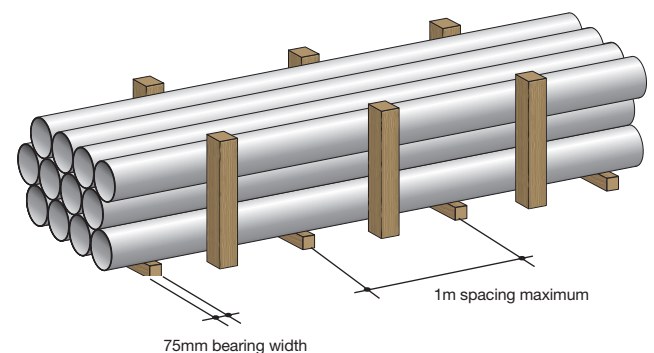

Figure 40: Storage of loose pipe on bearers



Installation

Wavin Osma Soil and Waste

Pipe Cutting and Jointing

Pipe Cutting

Procedure

1. Cut pipe cleanly at right angles to its axis (see Figure 41).
2. De-burr the cut end with a scraper if the cut end is to be inserted into a ring-seal or push-fit joint.
3. Chamfer the spigot end: this is essential to ensure that the sealing ring is not displaced during insertion.

Figure 41: Pipe preparation

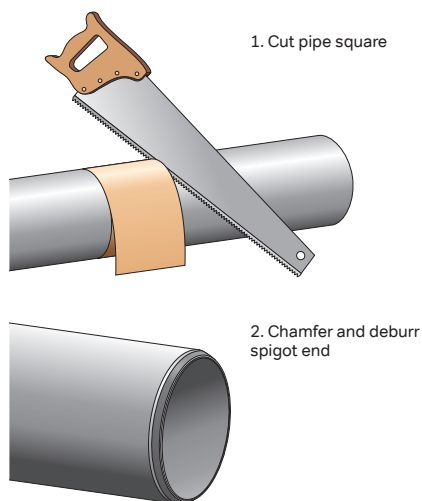

Ring-seal/Push-fit Jointing

Procedure

1. Ensure any pipe cut on site is also chamfered.
2. Check that the sealing ring is properly seated in its housing in the socket of the fitting.
3. Ensure all components to be joined are dry, clean and free from grit or dust. Note any deep scratches on the pipe or fitting spigot as these may prevent the sealing ring from forming a water tight seal.
4. Lubricate evenly around the pipe or fitting spigot end with Silicone Lubricant 4S391. Do NOT lubricate inside the socket. Do NOT use washing up liquid as a lubricant. If using 400ml can 4S392, spray the lubricant onto the spigot and not the ring seal. The spigot can then be inserted into the socket.
5. Correctly align the components to be joined.

6. Push the pipe or fitting spigot fully into the socket. Mark the pipe or fitting spigot at the socket face and then withdraw it by a minimum of 12mm to allow for thermal expansion (see Figure 42).
7. Make a subsequent check to ensure that the expansion gap is not lost during further installation work.

Figure 42: Ring-seal joint

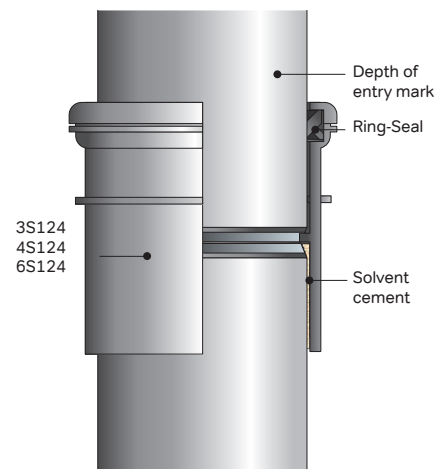

Table 21: Lubricant Usage Guide (approx.) For ring-seal/push-fit joints

Description	Part No.	Nominal Pipe Sizes (mm) No. of Joints					
		32	40	50	82	110	160
Silicone Lubricant 50g tube	4S391	44	37	20	16	9	4

Acoustic Socket (4S125)

The Osma acoustic socket is a special fitting used to connect plain ended pipe to a branch so that:

- Maximum acoustic performance is achieved by preventing structure borne sound
- Compensation is allowed for thermal movement on every floor without the need to employ the common practice of withdrawing pipe by 10mm from the fitting

This not only saves working time, but also gives additional technical security to the system. See next page for fitting instructions

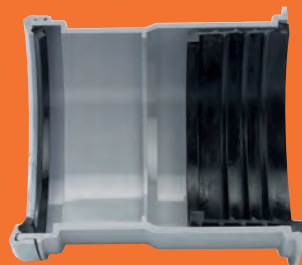

Acoustic Socket (4S125)

Fitting Instructions

When making the connection with the 4S125 Acoustic Socket, the following instructions should be adhered to. When installed vertically, please ensure that the gasket end is facing down.

1. Prepare the pipe

When fitting the acoustic gasket, cut the pipe to the required length, ensuring that the pipe end is deburred and cleaned. It is important that the pipe end is un-chamfered. Chamfering the pipe may result in the pipe pushing past the rubber stop-end at the end of the acoustic gasket, during thermal expansion.

2. Check the condition of the seal and gasket

It is recommended that you check the acoustic gasket and rubber seal for any site contamination. Clean if necessary.

3. Rubber acoustic gasket

Remove the rubber acoustic gasket from the coupler and push over the un-chamfered pipe end. Do not apply lubricant to either the pipe end or inside the rubber acoustic gasket as this may interfere with the combined movement of the pipe and gasket inside the body of the coupler, when in use.

4. Apply Osma Lubricant inside the fitting

Apply silicon lubricant to the inside of the socket which houses the acoustic rubber gasket. Never use oil or grease.

5. Apply Osma lubricant to the outside of the gasket

Apply silicon lubricant to the outside of the rubber gasket and then push the pipe and gasket assembly into the lubricated socket of the fitting until the gasket is fully inserted, with an 18mm expansion gap in place.

6. Check final position

Ensure the un-chamfered pipe end is flush with the stopend on the rubber gasket.

7. Complete Installation with pipe or fitting

For the remaining open connection, apply Osma lubricant to the spigot of the fitting (e.g. access pipe) or chamfered pipe end and insert into the standard ring-seal Osma socket.

Note: During and after installation, care must be taken to ensure that the expansion gap is retained. By installing the Acoustic Coupler with the access, it is possible to carry out a visual inspection by removing the screwed access cap and looking inside the fitting to check that the expansion gap is present. This will provide a check for the plumber and Building Control Officer that expansion allowance has been achieved on completion of the pipework.



Check out the new Acoustic Coupler videos on the Wavin UK You Tube channel - Osma Soil & Waste playlist.

Installation

Wavin Osma Soil and Waste

Solvent Weld Jointing

Procedure

- Before using any solvent based cleaners or cement:
 - Read instructions on the can
 - Ensure there is sufficient ventilation.
- Make sure pipe or fitting spigot and solvent weld socket are dry, clean and free from grit or dust.
- Clean surfaces of spigot and socket with Degreasing Cleaner N°.1 4S379/380. Apply liberally using a clean non-synthetic rag or absorbent paper.
- Apply one coat Solvent Cement N°.2 4S383/384/385. Apply an even coat to both surfaces using the applicator provided or a paint brush. Stroke the cement ALONG and not around the surfaces.
- Immediately insert pipe or fitting spigot fully into the socket (see Figure 43). Each solvent weld joint MUST be completed within 1½ minutes.
- Hold for 20-30 seconds. Remove any surplus cement from the mouth of the socket.
- The joint may be handled after 10 minutes and commissioned after 24 hours.

Figure 43: Solvent cement joint

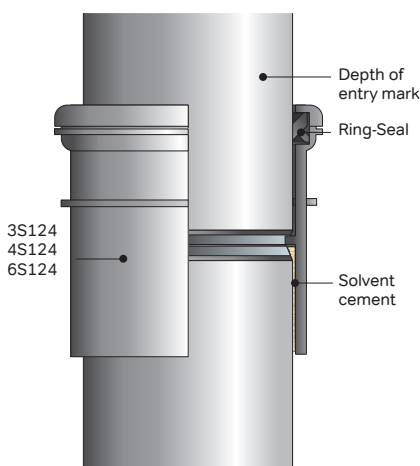

Safety

When making solvent weld joints it is essential to observe normal safety rules for handling solvent:

- Never smoke or bring naked flames near the area of work
- Work in a well ventilated area to avoid inhaling fumes
- Close the solvent container after use and store in a cool area
- Do not allow solvents or cleaners to come into contact with skin

Refer to COSHH Regulations (Control of Substances Hazardous to Health) where applicable.

For installation tips see:

 WavinUK

Table 22: Cleaner/Solvent Cement Usage Guide (approx.) For solvent weld joints

Description	Part No.	Nominal Pipe Sizes (mm) No. of Joints						
		21.5	32	40	50	82	110	160
Degreasing Cleaner No.1 125ml can	4S379	120	70	45	33	25	16	10
Degreasing Cleaner No.1 250ml can	4S380	240	140	90	66	50	32	20
Solvent Cement No.2 125ml can	4S383	90	45	30	20	8	5	3
Solvent Cement No.2 250ml can	4S384	180	90	60	40	16	11	6
Solvent Cement No.2 500ml tin	4S385	360	180	120	80	32	22	12

Pipe Support and Offsets

Pipe Support Centres

Pipes should be supported at the following maximum centres:

Table 23: Maximum Pipe Support Centres

Pipe Size (mm)	Centres (m)	
	Vertical	Horizontal
21.5	0.5	0.5
32	1.2	0.5
40	1.2	0.5
50	1.2	0.6
82	2	1
110	2	1
160	2	1.2

Suspended Brackets

The Osma Suspended Bracketing system provides horizontal support for socket and intermediate pipework for 110mm Soil installations. All fittings should be bracketed and braced using 4S085. Ensure that pipe is supported at recommended centres.

Socket Support 4S085

Components

- Threaded Rod
- Threaded Bracket
- Bracket Plate
- Adjustable Braces (2)
- Pipe/Socket Bracket

Procedure

1. Fix the Threaded Bracket to the ceiling using bolts appropriate for the ceiling material.
2. Screw the Threaded Rod into the Threaded Bracket.
3. Fix the Braces and Bracket Plate onto the Threaded Rod using the two nuts and washers provided.
4. Adjust the height of the Bracket Plate to the required fall, and cut the rod below the lower nut.
5. Adjust the length of the Braces using the nuts on the Braces themselves.
6. Fit the Pipe/Socket Bracket over the socket to be supported, directly behind the socket shoulder.

7. Fix the Pipe/Socket Bracket to Bracket Plate using the two bolts provided.
8. Fix the Braces to the ceiling: one at the side of, and one behind, the socket using bolts appropriate for the ceiling material.

NOTE: Not suitable for use in damp, inaccessible voids.

Figure 44: Suspended Bracketing (socket support)

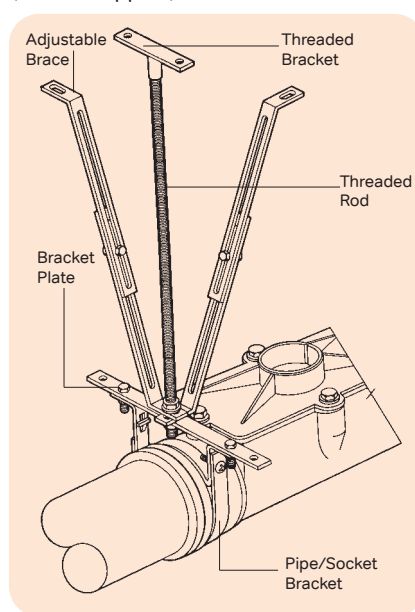

Intermediate Pipe Support 4S086/6S086

Components

- Threaded Rod
- Threaded Bracket
- Bracket Plate
- Pipe/Socket Bracket

Procedure

1. Fix the Threaded Bracket to the ceiling using bolts appropriate for the ceiling material.
2. Screw the Threaded Rod into the Threaded Bracket.
3. Fix the Braces and Bracket Plate onto the Threaded Rod using the two nuts and washers provided.
4. Adjust the height of the Bracket Plate to the required fall, and cut the rod below the lower nut.
5. Fit the Pipe/Socket Bracket over the pipe to be supported.
6. Fix the Pipe/Socket Bracket to Bracket Plate using the two bolts provided.

NOTE: Not suitable for use in damp, inaccessible voids.

Figure 45: Suspended Bracketing (intermediate pipe support)

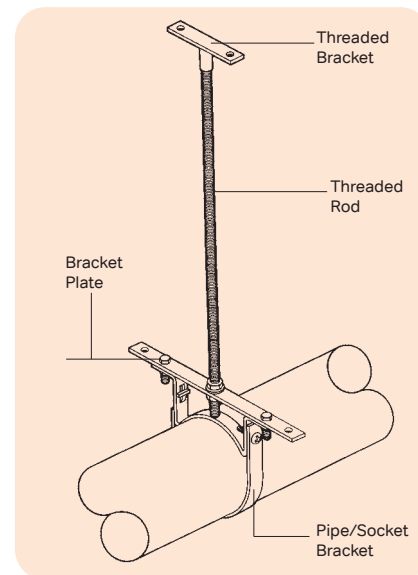

Offsets

The minimum offsets that can be achieved in each size (with part numbers) are as set out below:

Table 24: Minimum Achievable Offsets

Pipe Size (mm)	Part No.	Minimum Offset
82	3S444	115
110	4S444	155
160	6S435	233

Alternatively, for 110mm installations, use an adjustable bend (push-fit):

- 4S173 for 0° to 30° angles
- 4S179 for 0° to 90° angles

Installation

Wavin Osma Soil and Waste

Connections to Below Ground Drainage

Connections to PVC-U

110mm Osma Soil Pipe connections to PVC-U are straightforward using ring-seal/ push-fit jointing and Osma Below Ground Drainage fittings.

- Via OsmaDrain Bend 4D581

Figure 46: PVC-U drain socket (via 4D581)

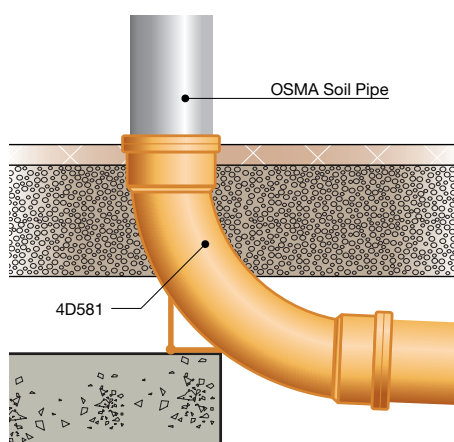

- Via OsmaDrain Coupler 4D205

Figure 47: PVC-U drain spigot (via 4D205)

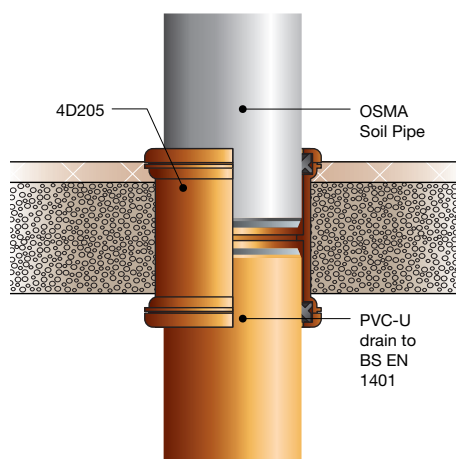

Connections to Other Materials

To thin-wall clay drain pipe spigot via OsmaDrain Adaptor 4D129

Procedure

– Use ring-seal/push-fit jointing method (page 104)

To cast iron soil socket via OsmaSoil Connector 4S106

Figure 48: Thin-wall drain spigot

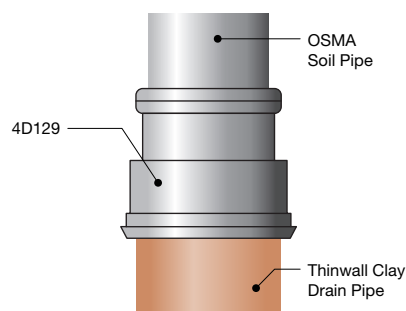

Procedure

1. Apply a bead of non-setting mastic to the face of the Connector and position centrally in the cast iron drain socket.
2. Caulk the joint with gaskin followed by lead wool, (NOT hot lead).

Figure 49: Cast iron drain socket

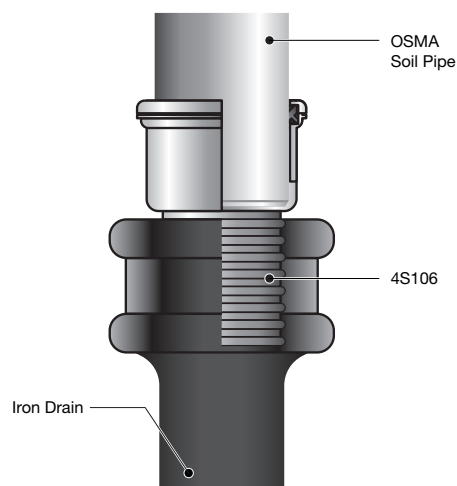

Connections to Other Materials

To cast iron soil socket via OsmaSoil Connector 4S206

Procedure

1. Place Connector inside cast iron socket.
2. Lubricate plain end of pipe.
3. Push in soil pipe spigot.

Figure 50: Cast iron soil socket

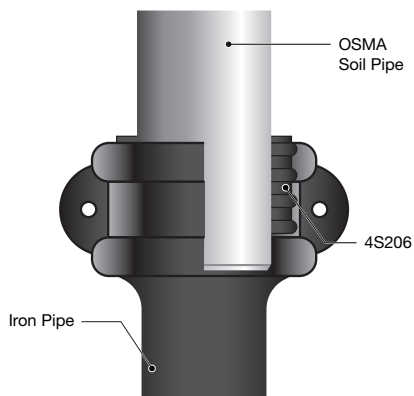

Access Saddle

Where access to soil pipework is required without using a fitting with an integral access facility, the Access Saddle 4S275 may be used on 110mm pipe to BS 4514.

Components

This comprises:

- Saddle
- Access Liner
- Access Cap
- Access Cap Gasket
- Clamp Ring
- Hole Template

Procedure

1. Mark the position on the pipe where access is required.
2. Cut a hole in the pipe EITHER with a pad saw using the template provided OR with a hole cutter 89mm in diameter and over 40mm depth.
3. Deburr and clean the area around the hole, and the mating surfaces, with Degreasing Cleaner No.1 4S379/4S380.
4. Apply Solvent Cement Filler 4S394 to the mating surfaces.
5. Fix Saddle to the pipe over the hole
NOTE: Application of solvent and fixing to pipe must be completed within 1½ minutes.
6. Clamp with the ring provided as steps illustrated (see Fig. 52).
7. The clamp may be removed after 10 minutes.

Figure 51: Access Saddle

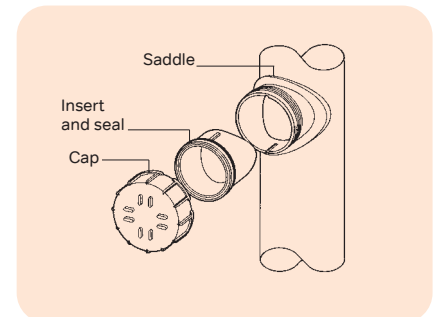
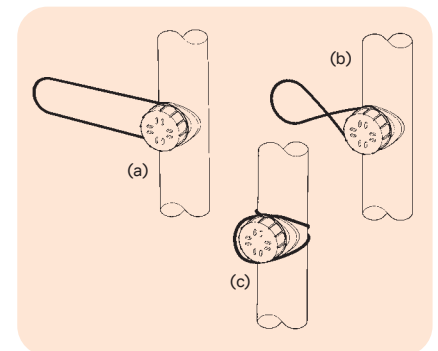

Figure 52: Installation of Access Saddle



Installation

Wavin Osma Soil and Waste

Soil Connections to Waste

Installing Boss Socket Adaptors

To use unperforated boss socket positions on Bossed Pipes and Bossed Branches:

Procedure

1. Drill required unperforated boss socket position with 50mm hole cutter.
2. Deburr and clean area around hole with Degreasing Cleaner No. 1 4S379/4S380.
3. Apply Solvent Cement No.2 4S383/4S384/4S385 to both mating surfaces.
4. Fit the appropriate Boss Socket Adaptor ensuring the top locating key fits into the corresponding key-way on the fitting.

Installing Short Boss Pipe – 4S588

32, 40 and 50mm pipe may be connected via appropriate Boss Socket Adaptor as normal procedure described above (see Boss socket Adaptors above).

Alternatively, 40mm pipe may be directly connected via a solvent weld socket:

1. Open spigot connection using 35mm hole cutter.
2. Deburr and clean area around hole with Degreasing Cleaner No. 1 4S379/4S380.
3. Solvent weld appropriate socket onto spigot tail of the bossed connection. For solvent weld jointing procedure, see page 106.

Permitted Connections

Bossed Branches have maximum five waste socket positions. These may be utilised as follows:

- Two waste pipes to one side
- One waste pipe each side on the same level
- Single connections at side and rear

Figure 56: Permitted connections

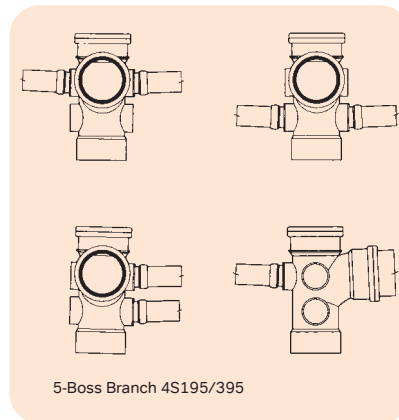

Connections NOT Permitted

Offset socket connections are not permitted.

Figure 57: Connections NOT permitted

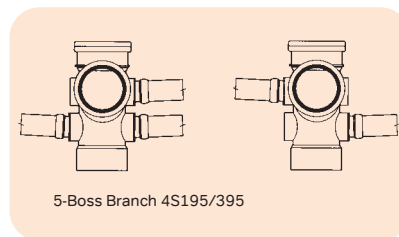

Connection of Multiple Wastes

Figure 58: Connection of multiple wastes

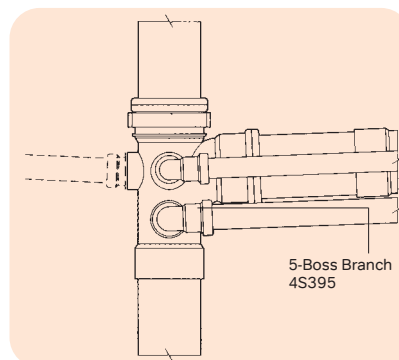

Installing Strap Bosses

Components

Strap Bosses 4S318, 3S319 and 4S319 provide an inexpensive method of connecting waste from basins, baths, bidets and showers fittings to 110mm soil stack pipework:

Procedure

1. Mark the position on the stack where the boss is required.
2. Drill a 56mm diameter hole.
3. Deburr and clean the area around the hole with Degreasing Cleaner No. 1 4S379/4S380 and clean the mating surface of the Boss.
4. Apply Solvent Cement Filler 4S394 to the mating surface of the Boss.
5. Fit the Boss to the hole ensuring 'top' is uppermost, and bolt together.
6. Allow 24 hours before completing Boss Socket Adaptor connection.

Figure 59: Connection of Strap Bosses

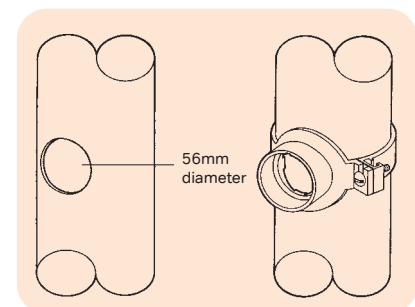
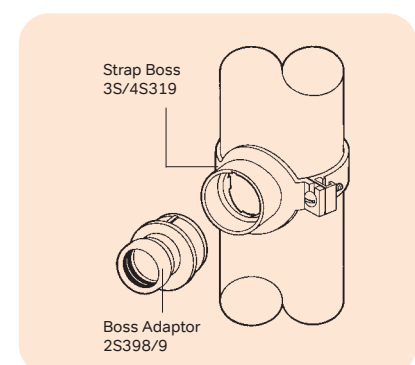

Figure 60: Fitting Boss Socket Adaptor



Installing Soil Manifold

The OsmaLink Soil Manifold provides a simple method of making up to three waste pipe connections to the stack at floor level. No drilling, sawing or welding is necessary for installation.

The sockets allow direct connection for 50mm pipe, and connection of 32mm and 40mm pipe via reducers to BS EN 1451-1, BS 5254, BS 5255 and copper wastes to BS 659 and BS 2871.

Horizontal connections

Make horizontal connections using the following bends/adaptors:

- For 50mm pipe – use the All-Fit 90° Spigot Bend 2S356
- For 40mm pipe – use the All-Fit Reduction Bend 2S355
- For 32mm pipe – use All-Fit Reducer 4Z124 with All-Fit Reduction Bend 2S355

Vertical connections

Make vertical pipe drops into the OsmaLink Soil Manifold as follows:

- For 50mm pipe – no reducer/adaptor required
- For 40mm pipe – use synthetic rubber Reducer 2Z349
- For 32mm pipe – use synthetic rubber Reducer 2Z347

Locate Reducer in socket as follows:

Procedure

1. Lubricate the Reducer.
2. Push into the required socket. The OsmaLink Soil Manifold is supplied with one open socket. To use the other sockets, simply remove the socket plugs. The connections are push-fit. There is no need for solvent welding.

6 Boss Soil Manifold – 4S597

A compact manifold designed for easier installation where space is restricted. It is particularly suitable for multi-occupancy residential buildings. See page 93 for further details.

For installation tips see:

 WavinUK



Figure 61: Typical OsmaLink Soil Manifold installation (side view)

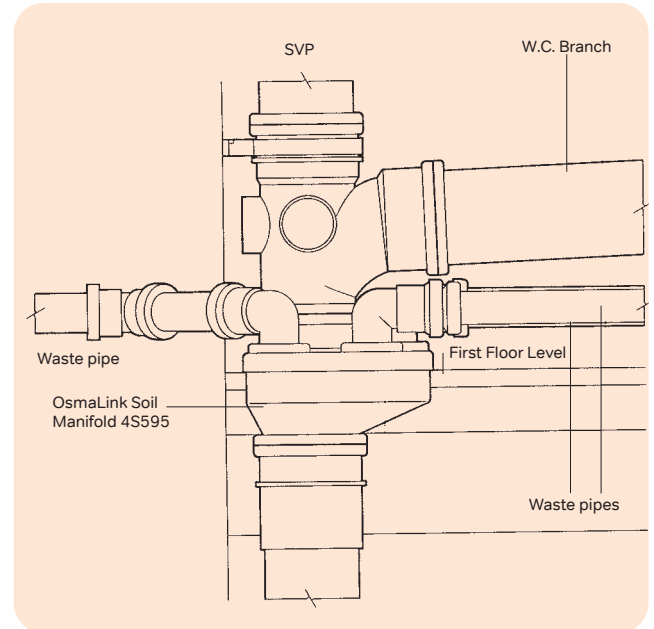
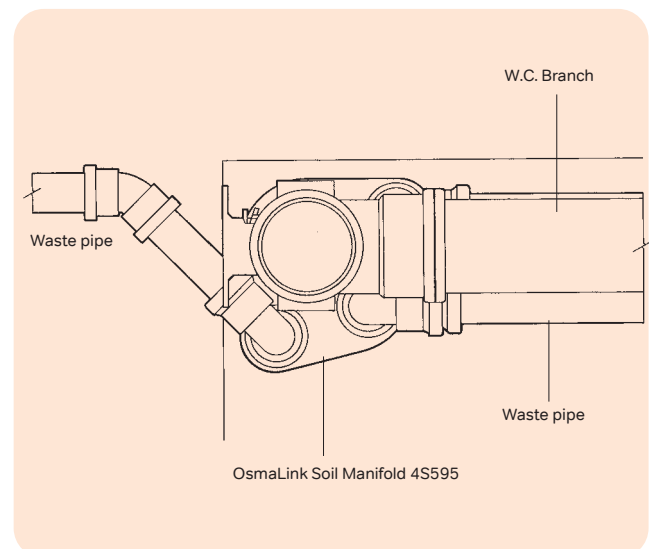

Figure 62: Typical OsmaLink Soil Manifold installation (plan view)



Installation

Wavin Osma Soil and Waste

Air Admittance Valves

OsmaVent 110

The OsmaVent 110mm Air Admittance Valve 4S304/4S306 (AAV 110) is designed for venting 110mm soil pipe stacks. It prevents siphonage and protects traps by allowing air into the discharge pipework without allowing foul air to escape.

Soil Stack Ventilation

See page 99-100 for details on ventilation.

For connecting to 110mm pipe

Procedure

1. Cut the 110mm PVC-U pipe square to its axis.
2. Clean and remove swarf.
3. Push-fit the valve into the pipe end (no lubrication necessary).
4. To achieve the A1 rating -20°C the 4S304 will require the top half of packaging to be fitted over it.
5. To achieve A2 rating 0°C, the 4S306 does not require insulating when used in the loft.

For connecting to 82mm pipe

Procedure

1. Remove rubber connector from AAV.
2. Solvent weld AAV onto short length of 82mm pipe.
3. 82mm pipe should be connected to the soil stack via a ring-seal fitting to allow the AAV to be easily removed for access to drainage system.

Soil Stack Ventilation

If a stub stack access assembly, to which ground floor cloakroom appliances are commonly connected, is discharging into a non-vented nearby drain, it will require venting eg. via AAV.

The Osma 110mm Air Admittance Valve 4S304 may be used to vent a stub stack in the following circumstances:

- If the crown of the WC trap is more than 1.5m above the drain invert

Figure 63: Vented stub stack

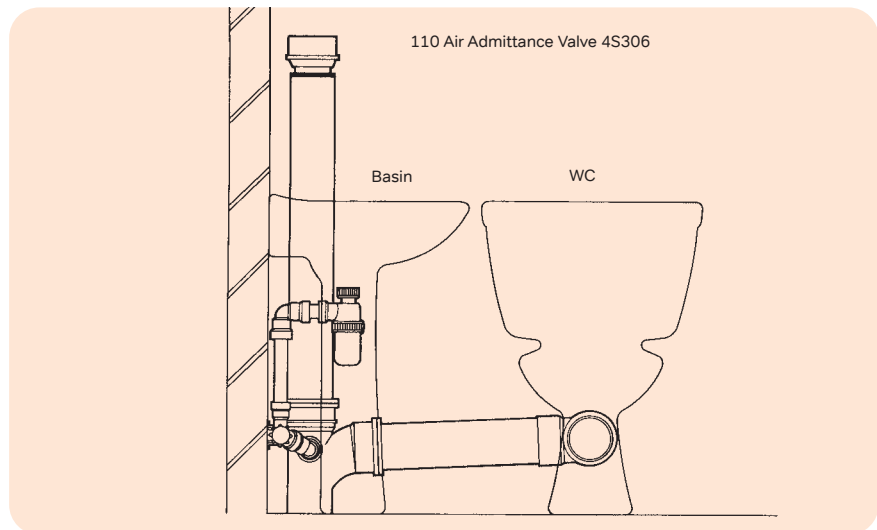

- The topmost connection to the stack is more than 2m from the drain invert

OsmaVent 40

Designed for venting waste systems when the length of waste pipe from trap to stack exceeds the following dimensions:
40mm pipe: 3m
50mm pipe: 4m

The OsmaVent 40mm Air Admittance Valve 4S303 (AAV 40) prevents siphonage and protects traps by allowing air into discharge pipework without allowing foul air to escape. It is suitable for venting up to 5 wash basins.

OsmaVent 40 push-fits onto 32 and 40mm (1¼"1½") waste pipework to BS EN 1451-1, BS EN 1455-1 and BS EN 1566-1.

It should be installed vertically and located in an accessible space.

Figure 64: Installation of OsmaVent 40 – In areas of extreme temperatures

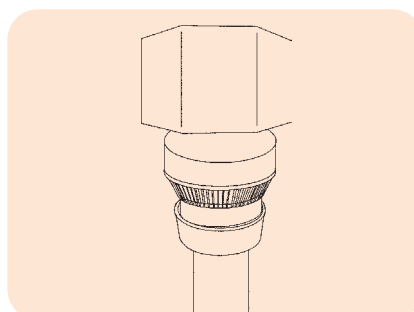

For connecting to 32mm pipe

Procedure

1. Install the valve directly onto the deburred pipe.
2. In areas of extreme temperatures cover the installed valve with the insulation.

For connecting to 40mm pipe

Procedure

1. Remove the connector from base of valve.
2. Pull away the inner part of connector.
3. Ensure the pipe is cut square and remove burrs. Push the connector approx. 50mm down the pipe.
4. Place valve on top of pipe.
5. Holding the valve onto the pipe push up the connector until secure over the valve.
6. In areas of extreme temperatures cover the installed valve with the insulation.

For installation tips see:

 WavinUK

Weatherproofing Soil Stack

Installing Weathering Collar

For maintaining watertight seal between pipe and traditional flashing:

Fittings – Weathering Collar

- 82mm 3S300
- 110mm 4S300
- 160mm 6S300

Procedure

1. Apply solvent weld to pipe immediately above flashing upstand using Solvent Cement Filler 4S394.
2. Slide down into position with cone section over the flashing upstand to form a 'watershed'.

Figure 65: Installation of Weathering Collar

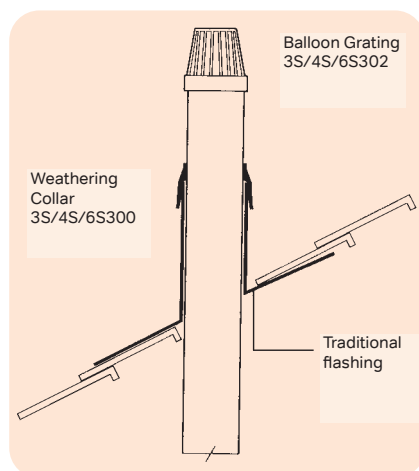

Installing Pipe Flashings

VariPitch Pipe Flashings are suitable for use on pitched or flat roofs, and with felt or asphalt finishes for 82mm or 110mm PVC-U pipe.

Fittings

- For flat roofs: VariPitch Pipe Flashing 4S281 (400 x 400mm)
- For pitched roofs between 12° and 55°: VariPitch Pipe Flashing 4S283 (450 x 450mm), VariPitch Pipe Flashing 4S285 (600 x 600mm)

Figure 66: Installation of VariPitch flashings – pitched

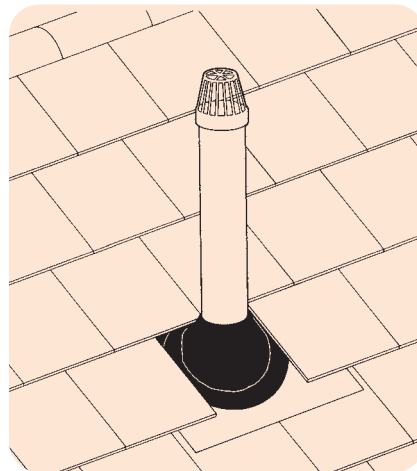
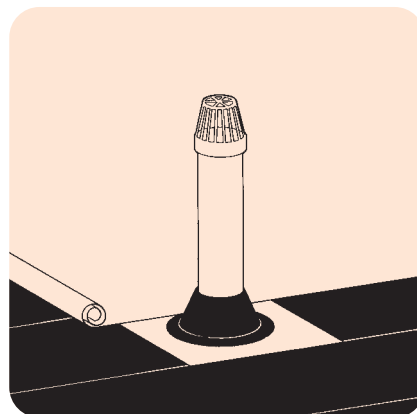

Figure 67: Installation of VariPitch flashings – flat



Pitched Roofs

Procedure

1. Secure vent pipe in position through roof.
2. If necessary, lubricate pipe with silicone lubricant to enable flashing to slide into position.
3. Fit flashing over stack pipe, and dress to suit roof tile profile.
4. To aid rigidity in exposed locations, a welt may be formed on front and side edges of apron.
5. Ensure back of apron is supported to prevent sagging between the rafters.

Flat Roofs: Felt

Procedure

1. Secure vent pipe in position through roof.
2. If necessary, lubricate pipe with silicone lubricant to enable flashing to slide into position.
3. Fit first layer of felt around the pipe.
4. Fit flashing over stack pipe.
5. Bed flashing in bitumen.
6. Butt second layer of felt to the edge of the apron.
7. Fix third layer of felt in bitumen over the apron and around the cone of the flashing.

Flat Roofs: Asphalt

Procedure

1. Secure vent pipe in position through roof.
2. If necessary, lubricate pipe with silicone lubricant to enable flashing to slide into position.
3. Fit flashing over stack pipe.
4. Apply asphalt over apron. Do not allow asphalt to come into contact with the unsupported cone of the flashing.
5. For improved adhesion, turn back apron edge approximately 12mm before applying asphalt.

Installation

Wavin Osma Soil and Waste

Traps

Osma Waste pipes will fit directly into the integral compression joint on Osma V-Joint Traps and Compression Joint Traps.

V-Joint Traps

V-Joint Traps have a three-part compression type outlet incorporating an internal sleeve.

To connect pipe:

Procedure

1. Remove outlet nut, red outlet thrust washer and black wedge seal.
2. Clean off any burrs or rough edges and chamfer the inside of the pipe (if necessary).
3. BS EN 1451-1, polypropylene pipe should be first warmed in hot water to enable it to be pushed over the internal sleeve and into the trap.
4. Slide the nut and red washer over the pipe. Push the black seal onto the pipe with the thick end towards the red washer.
5. Firmly push the pipe into the trap. Slide the washer and seal to the edge of the outlet.
6. Hand tighten the nut, finishing with a quarter turn using a spanner or wrench

NOTE: If the plastic pipe is undersized, or out of shape, the end of the pipe may need to be warmed in hot water.

Figure 68: Connection to V-joint trap outlet

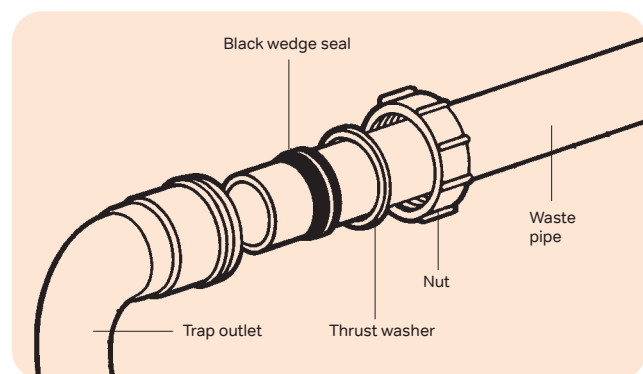

HepvO – Waterless Trap

For information on our unique water less trap see separate brochure – Wavin Osma HepvO Product and Installation Guide (SW102) and installation videos on You Tube.

For installation tips see:



All-Fit Conversion Bend

The 90° Conversion Bend 4A/5A830 converts a 'P' trap outlet to a 'S' trap outlet.

To connect pipe:

Simply lubricate the spigot end of the end and insert into the outlet socket of the trap.

Washing Machine Traps

Four different traps are available for connection to outlets of washing machines and dishwashers:

- 'P' Half Trap 5V864
- 'P' Full Trap 5V868
- Trap 5V870 with Standpipe and two brackets
- Adjustable 'P' Trap 5V869

Care should be taken to observe appliance manufacturer's installation instructions, particularly with regard to the height of the discharge hose and the incorporation of an air break or vent to atmosphere.

Washing Machine Traps

Procedure

1. To help prevent capillary action, wrap PTFE tape around the male thread prior to screwing into the threaded socket or screwing on the threaded nut.
2. Screw in hand tight plus a quarter turn. Do not over tighten, as damage may occur.

NOTE: Do NOT use linseed oil based jointing compounds with plastic components.

Making Bath Trap Overflow Connections

Procedure

1. Unscrew rose terminal and position in hole in bath.
2. Fit rubber washer over threaded spigot on the outside of the bath. Screw into socket of overflow connections.
3. Hand tighten and finish with a quarter turn with spanner or wrench.

Shower Gullies

The Wavin Osma range includes shower gullies for installation in tiled and sheet floor finishes.

Both models include pre-drilled countersunk screw holes to the flange for installation within a timber-joisted floor.

Shower Gully – Tiled Floor

Procedure

1. Cut hole in moisture resistant flooring board to take gully. Recess board so that top of drain flange is level with deck.
2. Firmly secure drain body to deck via the pre-drilled crew holes to flange.
3. Connect pipe using solvent weld joint.
4. Apply waterproof membrane to manufacturer's instructions. Dress over rim of gully and secure with clamping ring.
5. Affix tiles with approved waterproof adhesive, ensuring the Osma tile or stainless steel tile is square over the gully.
6. Insert circular grate in pre-formed hole in tile.

Shower Gully – Sheet Floor

Procedure

1. Cut hole in moisture resistant flooring board to take gully. Recess board so that top of drain flange is level with deck.
2. Firmly secure drain body to deck via the pre-drilled screw holes to flange.
3. Connect pipe using solvent weld joint.
4. Lay the sheet flooring to manufacturer's instructions. Dress over rim of gully and trim sheet to edge of clamping rim screw holes.
5. Screw clamping ring firmly in position.
6. Engage bell, ensuring 'O' ring lodges beneath screw heads on the clamping ring.

Pipe Connection

Connect pipe to Shower Gully via a solvent weld joint. For jointing procedure, see page 106.

Overflows

Connection to Tanks and Cisterns

The Osma PP Push-Fit Overflow system connects to tanks and cisterns via 90° Bent Tank Connector 1C139 (item supplied with two gaskets). This can be converted to a straight connector by cutting off the bend.

To connect the PVC-U Osma Solvent Weld Overflow system, use either Straight Tank Connector 1E129 or 90° Bent Tank Connector 1E139 (each item is supplied with two gaskets).

Procedure

1. Drill a hole with a saw cutter.
2. Remove any burr or rough edge.
3. Position a washer on either side of the cistern wall and fit the connector.
4. Tighten the back nut with a spanner.
5. Connect pipe. No solvent or lubricant is required.

For connections to screened overflow on drinking water cisterns, refer to manufacturer's instructions.

Connection to 3/4" BSPT Male Thread

OsmaWeld Overflow pipework can be connected to 3/4" BSPT male thread using Cap and Liner 1E156.

Connection to BS 659 Compression Fittings

Osma PVC-U Solvent Weld Overflow pipework can be connected to compression fittings manufactured to BS 659 using Straight Adaptor 1O158 or 90° Adaptor 1O159.

Pipe Bending

21.5mm Overflow pipe may be bent to a minimum of 50mm [2"] radius.

Procedure

1. Using a blow lamp or butane torch, apply a gentle heat to the pipe approx. 50mm [2"] either side of the bend.
2. When the pipe is pliable, insert a standard 19mm [3/4"] bending spring.
3. Pull to the required radius and restrain while pipe cools.

NOTE: Bending of pipe in excess of 19mm [3/4"] is not recommended.

Installation

Wavin Osma Soil and Waste

Overflow Termination Options

After penetration of the building wall, overflow pipe ends on the exterior should be terminated in one of the two following ways:

- Splay cut end
or
- Fit with a 90° Tee 1E190 to inhibit entry of freezing draughts

Figure 70: Terminating overflow pipe

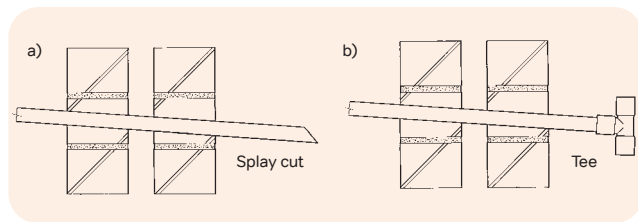

Tundish – for Overflow in Basement Areas

Unlike overflow systems above ground level, excess water from tanks or cisterns located in basement areas cannot be carried to a visible point on the building exterior.

To ensure that any overflow is visible in areas of a building below ground level, install a Tundish along the vertical route of the overflow pipe. This should be placed as near as possible to the cistern or tank, and in a visible position. A 25mm air gap should be allowed between the end of the overflow pipe and the rim of the Tundish in order to identify the source of the discharge.

IMPORTANT NOTE: Do NOT connect overflow pipework to soil and waste discharge stacks or branches.

Figure 71: Tundish connection to 21.5mm Solvent Weld Overflow Pipe

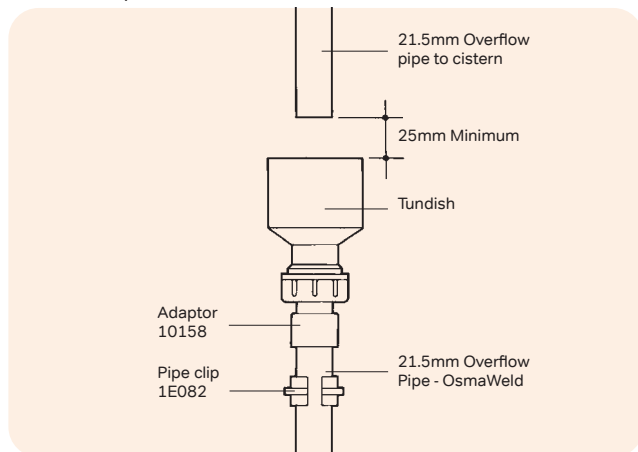

Overflow for a Range of WCs

The actual source of excess water flowing from a range of WC cisterns needs to be easily and quickly identified.

To ensure that any overflow discharge is identifiable and visible in such multiple installations, install Tundish between the overflow pipe from each cistern and a carrier manifold pipe. A 25mm air gap should be allowed between the end of the overflow pipe and the rim of the Tundish in order to identify the source of the discharge.

IMPORTANT NOTE: Do NOT connect overflow pipework to soil and waste discharge stacks or branches.

Figure 73: Typical Tundish – carrier pipe installation

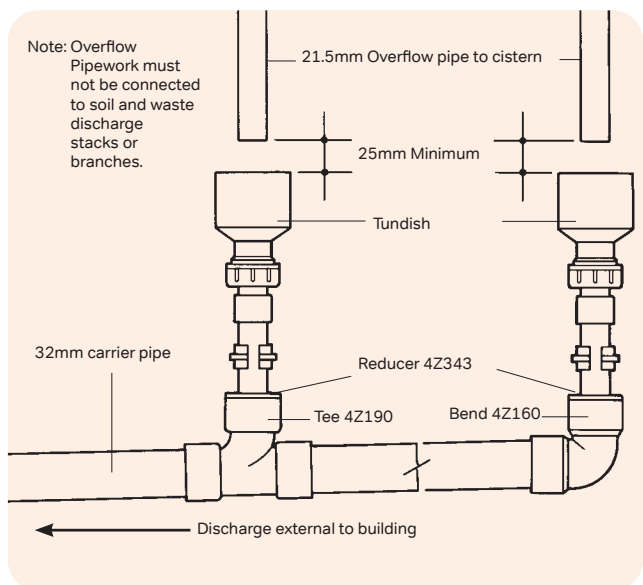
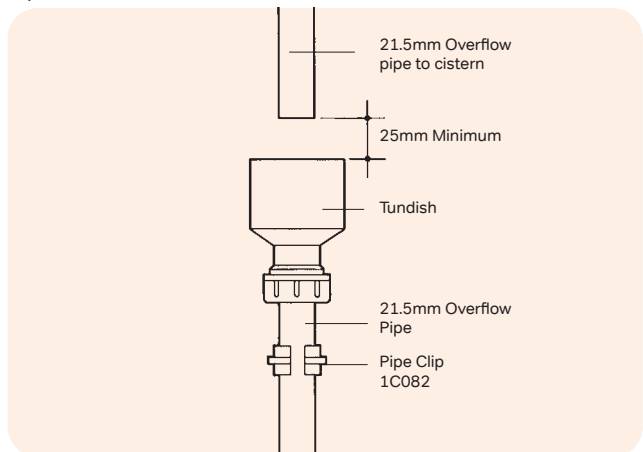

Figure 72: Tundish connection to 21.5mm Push-Fit Overflow Pipe



Maintenance, Repairs, Testing and Safety

Wavin Osma Soil and Waste

Maintenance

Wavin Osma Soil and Waste systems are designed to be virtually maintenance-free.

Blockages

In the event of any blockage, use only flexible or roller type rods. Metal pointed or boring types are not recommended.

Mechanised rodding should be carried out by trained operators only.

Cleaning Pipework

Cleaning can be undertaken with a damp cloth or mild detergent.

Air Admittance Valves

Periodically check that the diaphragm is clear of obstruction.

Fire Stop Seals

No maintenance required. However:

- Regularly inspect for any damage.
- Remove and replace any damaged seal.

Repairs

If a section of the soil stack requires replacement, either to effect repair or to incorporate a fitting post construction, use D/S Double Socket 3S/4S/6S105.

Procedure

1. Assemble all necessary fittings to be incorporated, or prepare the required length of pipe allowing for a minimum spigot length at each end as follows:
 - For 82mm or 110mm pipe: 60mm
 - For 160mm pipe: 100mm.
2. Cut out the appropriate length of the existing pipe, allowing for an expansion gap of 12mm at each end.
3. Chamfer and lubricate the spigots of the existing pipe and fit a D/S Double Socket completely over each one.
4. Position the new pipe section or assemble using socket brackets where necessary and lubricate the spigots.
5. Slide the D/S Double Socket over the new spigots to position each one centrally over the joint/expansion gap.
6. Fix the D/S Double Socket in place using socket brackets in their final position.

Testing

On completion of any installation work, the systems should be inspected and tested in accordance with BS EN 12056 and Part H of the Building Regulations.

Air testing is the preferred form of leak detection. The use of smoke testing of plastics pipework should be avoided.

Safety

The relevant regulations detailed in the Health and Safety at Work Act 1974 must be adhered to on site.

When making solvent weld joints it is essential to observe normal safety rules for handling solvent i.e.

- Never smoke or bring naked flames near the area of work
- Work in a well ventilated area to avoid inhaling fumes
- Close the solvent container after use and store in a cool area
- Do not allow solvent or cleaners to come into contact with the skin

COSHH (Control of Substances Hazardous to Health) Regulations should be referred to where applicable.

Copies of data sheets are available from the Technical Design Department. Contact Wavin Technical Enquiries.

Figure 76: Incorporating a fitting

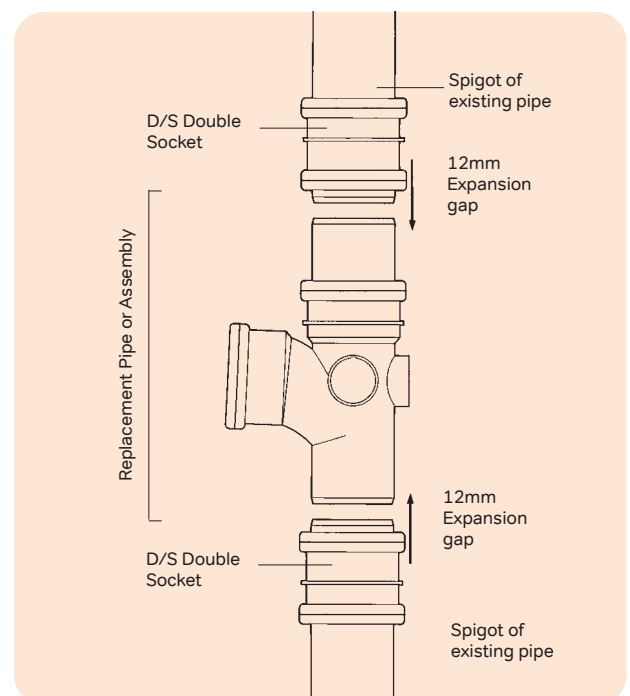

General Information

Wavin Osma Soil and Waste

Materials

Pipes and most fittings in Wavin Osma Soil and Waste systems are manufactured from the following materials, as individually denoted in the product listings in this Guide.

Material	Systems
PVC-U Unplasticised Polyvinyl Chloride	Soil systems and Solvent Weld Overflow system (pipe only)
PP Polypropylene	Push-Fit Waste system and Push-Fit Overflow system
ABS Acrylonitrile Butadiene Styrene	ABS Solvent Weld Waste system and Solvent Weld Overflow system (fittings only)
PE Polyethylene	V-Joint Traps

Acceptance

Wavin Osma Soil and Waste systems comply, where applicable, with the requirements of the following British Standards:

- BS EN 274-1:2002 Waste fittings for sanitary appliances
- BS 3943:1983 Specification for waste traps
- BS 4514:2001 Unplasticised PVC soil and ventilating pipes, fittings and accessories (82.4mm minimum mean outside diameter)
- BS 6209:1982 Solvent cement for non pressure thermoplastics pipe systems
- BS EN 1329-1:2000 Plastics piping systems for soil and waste discharge (low and high temperature) within the building structure. PVC-U
- BS EN 1453-1:2000 Plastics piping systems with structured-wall pipes for soil and waste discharge (low and high temperature) inside buildings. Unplasticized poly (vinyl chloride) (PVC-U)
- BS EN 1451-1:2000 Plastics piping systems for soil and waste discharge (low and high temperature) within the building structure. PP
- BS EN 1455-1: 2000 Plastics piping systems for soil and waste (low and high temperature) within the building structure. ABS
- BS EN 1566-1:2000 Plastics piping systems for soil and waste discharge (low and high temperature) within the building structure. PVC-C Chlorinated poly (vinyl chloride)
- BS EN 12380:2002 Air admittance valves for drainage systems



The British Standard Kitemark identifies pipe and fittings that are manufactured under the BSI certification scheme.



Wavin Osma Soil systems have been awarded British Board of Agrément [BBA] certification as follows:

- Air Admittance Valve 40 and Air Admittance Valve 110 (page 51, 60 and 64) – 86/1643
- 110mm Adjustable Bends (page 20) – 89/2174

References

Wavin Osma Soil and Waste systems should be designed and installed in accordance with the guidance provided in the appropriate sections of the following:

- Building Regulations 2000 (England and Wales): Approved Document H, Part H1
- Building Standards (Scotland) Regulations 1993-2002 (including current amendments: Technical Standards Part M)
- Building Regulations (Northern Ireland) 2000: Technical Booklet N
- BS 8000 Workmanship on Building Sites: Part 13: 1989 Code of Practice for above ground drainage and sanitary appliances
- BS EN 12056: 2000 Gravity drainage systems inside buildings: Part 3 Roof drainage, layout and calculation
- Painting plastics: IP 11/1979. Watford, BRE 1979
- Water Regulations Guide: London, Water Regulations Advisory Scheme, 2000
- BS EN 752:2008 – Drain and sewer systems outside buildings

Health and Safety

The relevant provisions of the following legislation should be adhered to on site:

- Construction (Design and Management) Regulations 1994
- Control of Substances Hazardous to Health Regulations 1988
- Health and Safety at Work Act 1974
- Management of Health and Safety at Work Regulations 1999
- Manual Handling Operations Regulations 1992

Hazards Associated with PVC-U, ABS, Polypropylene and Polyethylene

There are no particular hazards associated with handling, cutting or working with the materials mentioned above, and protective clothing or equipment is not normally required.

Copies of Safety Data Sheets covering PVC-U, ABS, PP, PE, lubricant, solvent cements and cleaners are available from the Wavin Technical Design Department.

Abbreviations

Key	
P/E:	Pipe and fittings with both ends plain or with one plain end and one special end
S/S:	Pipe and fittings with one or more ring-seal or push-fit sockets, but always one plain or special end
D/S:	Fittings with ring-seal or push-fit sockets at all ends
S/SW:	Fittings with one or more ring-seal sockets but always one solvent socket
SW/S:	Fittings with one or more solvent sockets and one plain or special end
D/SW	Fittings with solvent sockets at all ends

Supply

All Wavin Osma systems are supplied through a nationwide network of merchant distributors. For details of your nearest stockist, contact Wavin Customer Services.

Sealing Rings

Where applicable, Sealing Rings are supplied fitted to each component and are included in the price.

Conditions of Sale

The Company will not accept responsibility for the malfunction of any installation which includes components not supplied by Wavin Limited. Goods are sold subject to Company conditions of sale.

'How to' Videos

To accompany this brochure, there is a set of installation 'how to' Osma Soil and Waste videos to show can make light work of challenging plumbing problems.

The installation videos can be viewed at www.youtube.com/WavinUK under the Osma playlist.

They currently include:

Wavin Osma Hep_vO Waste

- Waterless Trap System Overview
- Fitting pedestal basin waste in limited space situations
- Installing under a sink where space is at a premium
- Fitting a bath waste where depth is limited

Wavin Osma Soil and Waste

- Introducing Recycore Technology
- Push fit and solvent welded joints
- Making an offset joint
- Installing a soil manifold
- Flexible WC Connections
- Fitting drain connectors
- Installing a slip coupler
- Access for rodding
- Cutting a pipe square
- Installing a fire collar
- Allowing for pipe expansion
- Avoiding dislodged seals
- Making a solvent welded joint
- Installing air admittance valve
- Acoustic Coupler 4S125 – 60 second overview
- Acoustic Coupler 4S125 – Main benefits and installation

You can find other Wavin video's on the channel also, such as Rainwater, Hep₂O Plumbing and Underfloor heating systems.

For installation tips see:



Game Changing BIM Design Wavin Osma Soil and Waste

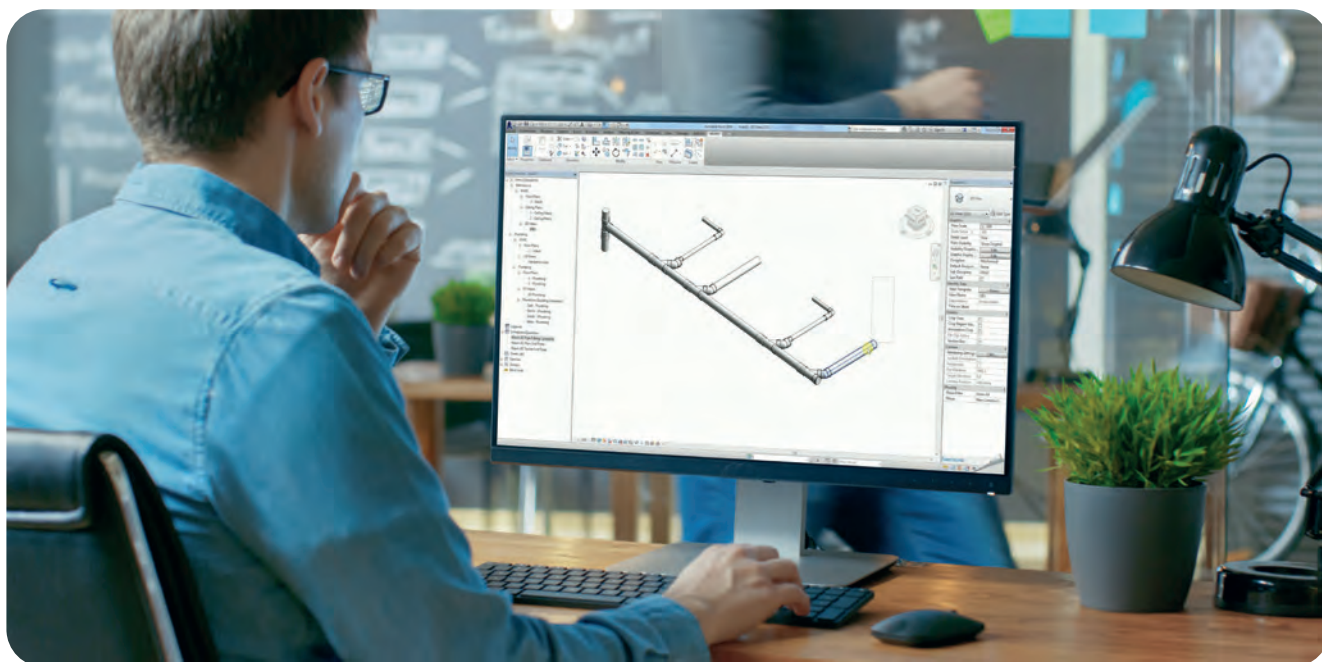

Building Information Modelling (BIM)

We have created Revit families with integrated intelligent assistance to help you reach a complete 'as-built' pipe system in the fastest way possible, significantly reducing time spent on design.

Our Revit families help you reach a 100% accurate representation of the way piping systems will actually be installed, easily and without the use of product catalogues.

The quickest way to a complete 'as built' pipe system

Our Revit families for BIM ensure that the piping system selected can be installed as designed using only existing products in our portfolio that are available to install, saving time for both the engineer and contractor.

Precise Designs with Intelligent Assistance

Intelligent assistance can double productivity on-screen and on-site. The unique intelligent design assistance in Wavin's BIM Revit packages can slash project delivery time and costs through more accurate, faster and easier pipe modelling. The result is 'as-built' designs that reduce risk, eliminate waste and enhance productivity at every stage of a project.

Fully integrated Bill of Materials

Wavin Revit families contain an accurate Bill of Materials for each of our ranges including both pipes and fittings ready for you to order from your preferred distributor.

Our Revit packages are available in all of our above ground soil, waste, plumbing and heating systems, including;

- Wavin Osma Push-Fit Soil & Waste
- Wavin Osma Solvent Weld Soil and Waste
- Wavin Osma Traps and Accessories
- Wavin AS+
- Wavin HDPE
- Wavin Tigris K1/K5
- Wavin Solvent Soil and Waste
- Wavin Hep₂O

You can also see lots of tips and tricks of how to use Wavin Revit families at myportal.wavin.co.uk.



Wavin is part of Orbia, a community of companies working together to tackle some of the world's most complex challenges. We are bound by a common purpose: To Advance Life Around the World.

Orbia's Building and Infrastructure business Wavin is an innovative solutions provider for the global building and infrastructure industry. Backed by more than 60 years of product development experience, Wavin is advancing life around the world by building healthy, sustainable environments for global citizens. Whether it's to improve the distribution of clean drinking water, to make sanitation accessible for everyone, to create climate resilient cities, or to design comfortable living spaces, Wavin collaborates with municipal leaders, engineers, contractors, and installers to help future-proof communities, buildings and homes. Wavin has 12,000+ employees around 65 production sites worldwide, serving over 80 countries through a global sales and distribution network.

Wavin Limited | Edlington Lane | Doncaster | DN12 1BY
Tel: 0800 038 0088 | Web: www.wavin.co.uk | E-mail: info@wavin.co.uk

© 2023 Wavin Wavin reserves the right to make alterations without prior notice. Due to continuous product development, changes in technical specifications may change. Installation must comply with the installation instructions.