

Product guide

# Wavin PP-R and PP-RCT Pipe Systems

Hot and Cold Water Systems  
and Heating Applications



**wavin**

orbia 







Wavin is one of the leading companies in the plastic pipe industry in Turkey. Our company offers a wide range of high-quality pipe and fittings system solutions for building and infrastructure. Our company, which has a history of more than half a century, started production in 1971 in Adana. Wavin Plastik A.Ş. was purchased by Wavin B.V, the largest European company in its own field in the Netherlands in 2008.

In 2012, all Wavin companies joined the Mexichem family which is South America's giant petrochemicals and raw materials producer. Mexichem announced its new name as ORBIA in 2019. ORBIA, with its new changing business structure, provides professional support to its customers with its products and services in 5 main business lines: Building & Infrastructure, Flour, Datacom, Precision Agriculture and Polymer Solutions. With the new structuring of ORBIA, its main mission is to advance life around the world.

In 2019, with the renewed business structure of ORBIA, building & infrastructure business line was started to represent by WAVIN, a single and strong brand across the globe. WAVIN operates in more than 40 countries around the world in 4 main regions: Europe-Middle East-Africa, Asia-Pacific, Latin America and USA-Canada with 12.000 employees.

Wavin is now a global leader in the supply of plastic pipe systems and solutions for both above and below ground applications in projects around the world. Since the 1950s, we have built an unrivalled reputation for continuous innovation, intelligent problem-solving, dedicated technical support and the highest standards.

Wavin Turkey offers traditional products such as PPR-C clean water, PVC wastewater as well as the innovative products such as Tigris Press-fit systems, Sentio underfloor heating control, SiTech+ low noise pipes, Qickstream siphonic rainwater drainage systems, Q-Bic Plus infiltration systems, Tegra plastic manholes etc. to the sector. Wavin Academy which is the first training centre of the sector was opened in 2014 within our factory in Adana, Tens of thousands of visitors from various levels of the mechanical installation sector have been able to increase their expertise by attending training at Wavin Academy since 2014. Our company provides fast service with Adana, Istanbul, Ankara and Izmir offices, distribution centres located in Istanbul and Adana and wide dealers network. In addition to our sales staff, our expert engineers and technical personnel support our customers for the projects.

To get more information about our company and products, please visit our website [www.wavin.com.tr](http://www.wavin.com.tr) and follow us on our social media accounts.



## Building Healthy, Sustainable Environments

Our purpose is “Building Healthy, Sustainable Environments” as Wavin in global. To reach that goal one first driver is “Safe and Efficient Water Supply”. We care human health and this is the way how we manage our product portfolio.



PPR Pipes and Fittings used in several applications like potable water, heating and cooling or industrial applications. The PPR system basically based on pipes, full plastic fittings, fittings with inserts, valves and tools.

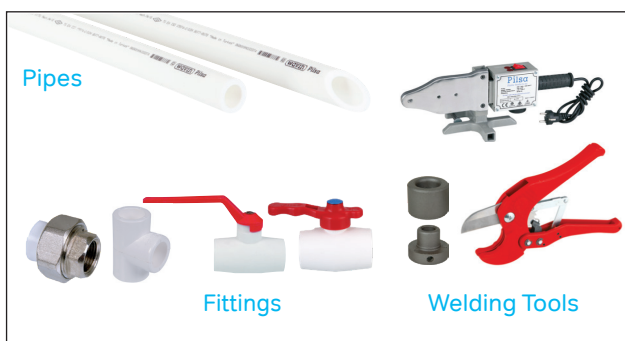

According to the European drinking water directive and hygienic assessment of materials in contact with drinking water, nickel coating is no more applicable for tap water installations. That is why we removed nickel coating from our PPR fittings with metal inserts which are used in drinking water applications globally.

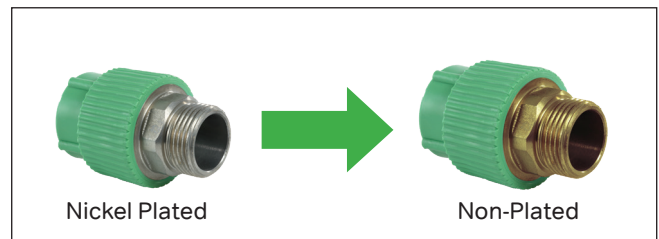

The new PPR Fittings are non-coated brass alloy which is in the acceptable alloy list in 8th revision of 4MS 2017. Metal deactivators are used in the recipe in order to avoid any damage on plastic parts that may be caused by free metal ions from inserts. This application is valid for every color of fitting. PPR Fittings will continue to meet all performance requirements of EN ISO 15874-3 standard. You can reach to international product certifications via Wavin representative.



## Extensive Product Range

### Above Ground Product Groups:

- PPR&PP-RCT Pipes & Fittings and Composite PPR & PP-RCT Pipes
- PEX and Pert Pipes - Protected PEX and Pert Pipes and Fittings
- OXY PEX and Pert Pipes - Protected OXY PEX and Pert Pipes
- Underfloor Heating and Sentio control systems
- Tigris Press Fitting Systems
- Wavin AS+, SiTech+ and SiTech B1 low noise systems
- Wavin Quickstream Siphonic Roof Drainage System
- U-PVC Soil and Waste System
- HepVO Waterless Trap

### Below Ground Product Groups:

- U-PVC Pressure Pipes & Fittings
- PE Pipes (LDPE & HDPE)
- Wavin PE Fittings (Electrofusion - Spigot)
- Wavin Plastic Manholes (Inspection Chambers) & Fittings
- Apollo O-PVC Pressure Pipes
- Separators
- Road Gullies
- Aquacell ve Qbic plus attenuation and infiltration tanks



## Why Would You Collaborate With Wavin Turkey?

Wavin Turkey provides the best quality as one of the market leader and:

- ▶ Uses the most appropriate raw material,
- ▶ Has the most advanced high technology,
- ▶ Produces pipes in compliance with Turkish (TS), European (EN) and German(DIN) Standards,
- ▶ Produces pipes not only for water management but also a wide range of fluids.
- ▶ Has qualified technical staff in order to solve your problems.
- ▶ Stands for quality.

## Why Would You Prefer Wavin Pipes?

Wavin has got the following advantages:

- ▶ Not dangerous for human life, non-toxic, non-cancerous,
- ▶ Low cost of transportation; loading and unloading
- ▶ Has much longer service life compared to other piping systems,
- ▶ Has high resistance against corrosion,
- ▶ Can easily be connected to any kind of pipe. Due to low cost of plumbing, it has a wide range of applications,
- ▶ Water is one of the most important essential contributing to human life; Wavin pipes provide this vital fluid to your households in an easy and healthy way at a competitive price

## WAVIN POLYPROPYLENE PIPES

### • Wavin Pipes (PPR-Mono Layer)

- ▶ Superior physical characteristics at 90°C,
- ▶ High chemical resistance,
- ▶ Definite solutions to calcification and corrosion,
- ▶ No bacteria and moss reproduction within the pipes,
- ▶ Light, easy to install and low labor cost of installation,
- ▶ Safe to use various pressurized liquids and gas,
- ▶ No reduction in diameter at welding points,
- ▶ 60°C, 10 bars and 70°C, 8 bar pressure resistance for a service life of 50 years.
- ▶ Can be used in drinking water systems and has a quality certificate issued by the Ministry of Health and Hygiene-Institute

### • Wavin Pipes (PP-RCT Mono Layer)

- ▶ Wavin PP-RCT pipes are made of the raw material PP-RCT which is new generation polypropylene designed for hot and cold water systems.
- ▶ It is the better pipe with higher flow rate, improved pressure resistance and easier to handle.
- ▶ It has improved pressure resistance at higher temperatures for long term period.
- ▶ It has 37 % larger inner flow area
- ▶ Larger inner bore and better flow rates
- ▶ Wavin PP-RCT can be used with all standard Wavin PP-R fittings
- ▶ Available in different color options

### • Glass Fiber Reinforced Composite Pipes (PPR-Multi Layer)

- ▶ GFR PPR pipe is multilayered and elongates less during the heat differences.
- ▶ Unlike aluminium foiled pipes; there is no need to shave the end of the pipe. This provides ease of install.
- ▶ The linear coefficient of thermal expansion is very low (0,035mm/mK); accordingly greater stability. In comparison to standard pipes total quantity of clamps used is less, therefore total expenses reduces.
- ▶ Due to the low thermal conductivity of glass fiber itself, thermal conductivity coefficient of multilayer pipe is lower than solid wall pipe. Less insulation is necessary.
- ▶ It does not cause a change in the color, smell or the taste of water. It has a hygienic structure. Can easily be used for hot and cold water systems

### • Basalt Fiber Composite Pipes (PP-RCT Multi Layer)

- ▶ Pipes are multilayer and made of the raw material PP-RCT which is new generation polypropylene designed for hot and cold water systems.
- ▶ Basalt fiber is made of pulping melted basalt stones of suitable composition.
- ▶ It is very durable and flexible and used in many different industries.
- ▶ Properties of basalt fiber significantly exceed glass fiber.
- ▶ Manufacturing of basalt fiber is very ecological and 100% recyclable
- ▶ 4-x lower linear thermal expansion than solid wall pipes,
- ▶ No need to shave before welding
- ▶ Higher pressure resistance at higher temperatures by up to 50%
- ▶ Temperature resistance up to 90°C
- ▶ Higher flow rate by up to 20%

**PHYSICAL AND MECHANICAL PROPERTIES OF RAW MATERIAL - PP-R**

Properties	Testing Conditions	Unit	Testing Method	Result
MRS Classification	20°C, extrapolation 50 years	MPa	ISO 9080	10
Density	23°C	g/cm <sup>3</sup>	ISO 1183	0,89 - 0,91
Melting Flow Index MFI	190°C, 5 kg	g/10dk g/10min	ISO 1133	0,4 - 0,6
	230°C, 2,16 kg			0,2 - 0,5
	230°C, 5 kg			0,8 - 1,3
Tensile Stress at Yield	23°C, 50 mm/dk 50 mm/min	MPa	ISO 527	23 - 28
Tensile Strain at Yield	23°C, 50 mm/dk 50 mm/min	%	ISO 527	min %10
Elasticity Modulus	23°C, 1 mm/dk 1 mm/min	MPa	ISO 527	800 - 1000
Charpy Notched Impact Strength	0°C	kJ/m <sup>2</sup>	ISO 179	>3,5
Thermal Conductivity	-	W/(m K)	DIN 52612	0,24
Coefficient of Thermal Expansion (0°C/90°C)	-	1/K	DIN 53752	1,5*10 <sup>-4</sup>

**ISOTHERMAL MECHANICAL STRENGTH GRAPHIC FOR PP-R**

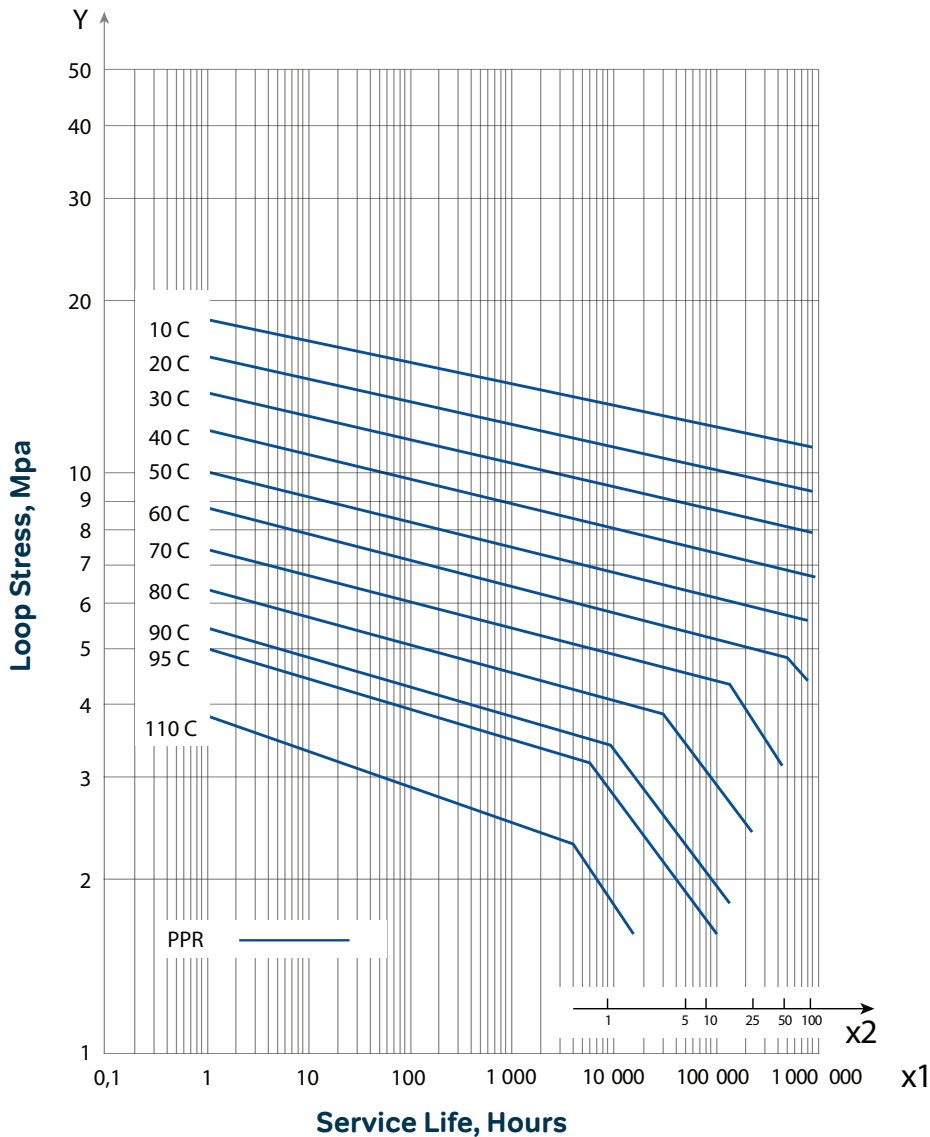



**PHYSICAL AND MECHANICAL PROPERTIES OF RAW MATERIAL - PP-RCT**

Properties	Testing Conditions	Unit	Testing Method	Result
MRS Classification	20°C, extrapolation 50 years	MPa	ISO 9080	11,2
CRS Classification	70°C, extrapolation 50 years	MPa	ISO 9080	5,3
Density	23°C	g/cm <sup>3</sup>	ISO 1183	0,89 - 0,91
Melting Flow Index MFI	190°C, 5 kg	g/10dk g/10min	ISO 1133	0,4 - 0,6
	230°C, 2,16 kg			0,2 - 0,5
	230°C, 5 kg			0,8 - 1,3
Tensile Stress at Yield	23°C, 50 mm/dk 50 mm/min	MPa	ISO 527	23 - 28
Tensile Strain at Yield	23°C, 50 mm/dk 50 mm/min	%	ISO 527	min %10
Elasticity Modulus	23°C, 1 mm/dk 1 mm/min	MPa	ISO 179	800 - 900
Charpy Notched Impact Strength	0°C	kJ/m <sup>2</sup>	ISO 179	9,5
Izod Notched Impact Strength	0°C	kJ/m <sup>2</sup>	DIN 52612	17
Thermal Conductivity	-	W/(m K)	DIN 52612	0,24
Coefficient of Thermal Expansion (0°C/90°C)	-	1/K	DIN 53752	1,5*10 <sup>-4</sup>

**ISOTHERMAL MECHANICAL STRENGTH GRAPHIC FOR PP-RCT**

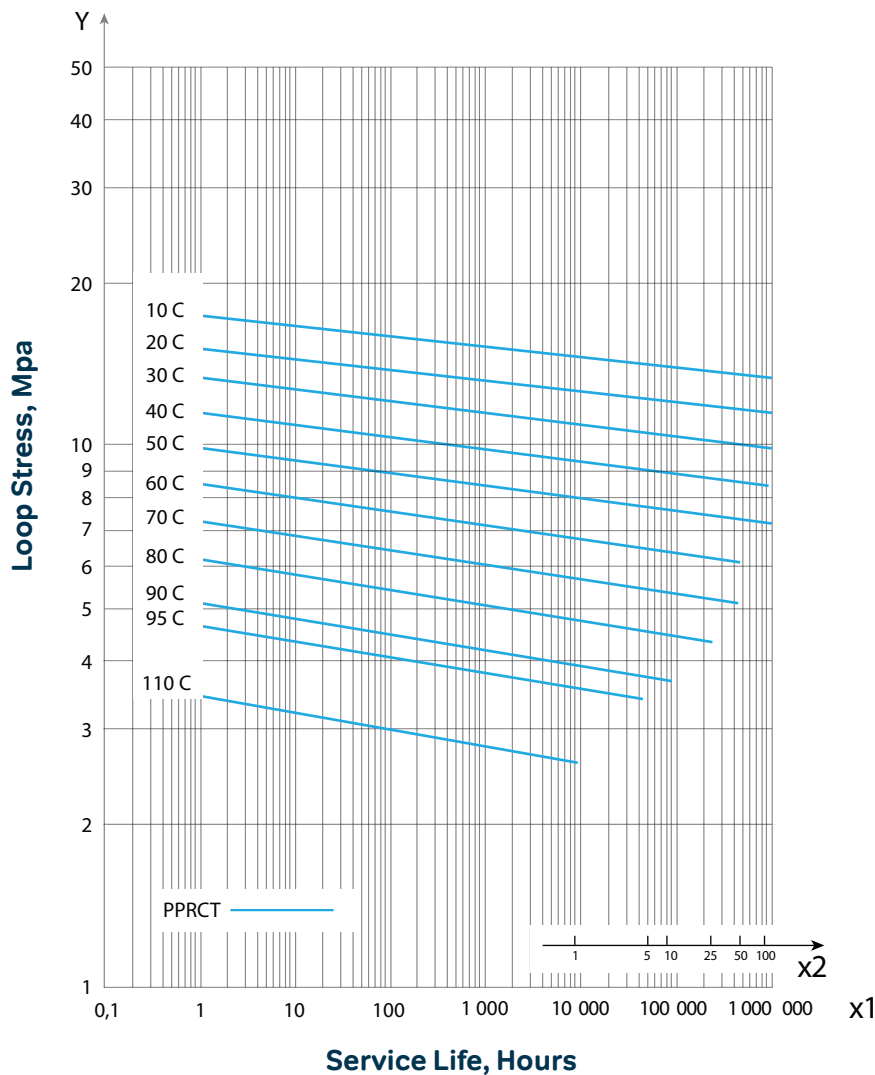

**OPERATING PARAMETERS FOR PP-R & PP-RCT PIPES**

		PP-R Pipe Glass Fiber Reinforced PP-R Pipe			PP-RCT Pipe / Basalt Reinforced PP-RCT Pipe		
		Operating Pressure			Operating Pressure		
Temp °C	Life (year)	S 2,5 SDR 6	S 3,2 SDR 7,4	S 5 SDR 11	S 3,2 SDR 7,4	S 4 SDR 9	S 5 SDR 11
10	1	35,1	27,8	17,5	30,2	24,0	19,0
	5	33,0	26,2	16,5	29,3	23,2	18,4
	10	32,2	25,6	16,1	28,9	22,9	18,2
	25	31,1	24,7	15,6	28,4	22,5	17,9
	50	30,3	24,1	15,2	28,0	22,2	17,7
	100	29,6	23,5	14,8	27,6	21,9	17,4
20	1	29,9	23,7	15,0	26,3	20,9	16,6
	5	28,1	22,3	14,1	25,4	20,2	16,0
	10	27,4	21,7	13,7	25,1	19,9	15,8
	25	26,4	21,0	13,2	24,6	19,6	15,5
	50	25,7	20,4	12,9	24,3	19,3	15,3
	100	25,0	19,9	12,5	24,0	19,0	15,1
30	1	25,4	20,2	12,7	22,7	18,1	14,3
	5	23,8	18,9	11,9	22,0	17,4	13,9
	10	23,2	18,4	11,6	21,7	17,2	13,6
	25	22,3	17,7	11,2	21,2	16,9	13,4
	50	21,7	17,2	10,9	20,9	16,6	13,2
	100	21,1	16,8	10,6	20,6	16,4	13,0
40	1	21,6	17,1	10,8	19,6	15,5	12,3
	5	20,2	16,0	10,1	18,9	15,0	11,9
	10	19,6	15,5	9,8	18,6	14,7	11,7
	25	18,8	15,0	9,4	18,2	14,4	11,5
	50	18,3	14,5	9,2	17,9	14,2	11,3
	100	17,8	14,1	8,9	17,6	14,0	11,1
50	1	18,2	14,5	9,1	16,7	13,3	10,5
	5	17,0	13,5	8,5	16,4	12,8	10,1
	10	16,5	13,1	8,2	15,8	12,6	10,0
	25	15,9	12,6	7,9	15,5	12,3	9,7
	50	15,4	12,2	7,7	15,2	12,1	9,6
	100	14,9	11,8	7,5	15,0	11,9	9,4
60	1	15,4	12,2	7,7	14,2	11,2	8,9
	5	14,3	11,3	7,1	13,6	10,8	8,6
	10	13,9	11,0	6,9	13,4	10,6	8,4
	25	13,3	10,5	6,6	13,1	10,4	8,2
	50	12,9	10,2	6,4	12,8	10,2	8,1
	100	12,9	10,3	6,5	11,9	9,4	7,5
70	1	12,9	10,3	6,5	11,9	9,4	7,5
	5	12,0	9,5	6,0	11,4	9,1	7,2
	10	11,6	9,2	5,8	11,2	8,9	7,0
	25	10,0	8,0	5,0	10,9	8,7	6,9
	50	8,5	6,7	4,2	10,7	8,5	6,8
	100	10,8	8,6	5,4	9,9	7,9	6,2
80	1	10,8	8,6	5,4	9,9	7,9	6,2
	5	9,6	7,6	4,8	9,5	7,5	6,0
	10	8,1	6,4	4,0	9,3	7,4	5,9
	25	6,5	5,1	3,2	9,1	7,2	5,7
95	7,6	1	6,1	3,8	7,4	5,9	4,7
	5,2	5	4,1	2,6	7,1	5,6	4,4
	4,3	10	(3,4)	(2,2)	(6,9)	(5,5)	(4,3)

\*Safety Factor (C): 1,5



## Pipes and fittings

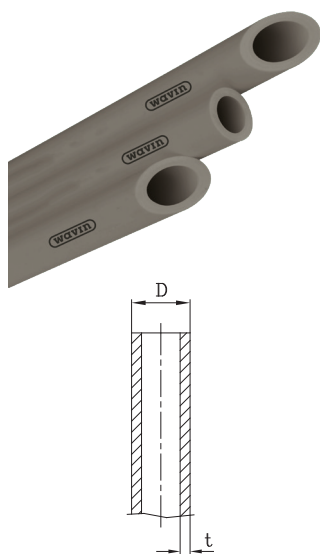

### Wavin PPR Pipe (PPR-4mt)

DN	t (mm) (10 Bar)	t (mm) (16 Bar)	t (mm) (20 Bar)	s 5 SDR 11 PN 10	s 3,2 SDR 7,4 PN 16	s 2,5 SDR 6 PN 20	Bundle
20	1.9	2,8	3.4	3040240	3050623	3050630	25
25	2.3	3,5	4.2	3040241	3050638	3050644	20
32	2.9	4,4	5.4	3040242	3050652	3050658	10
40	3.7	5,5	6.7	3040243	3050666	3050670	5
50	4.6	6,9	8.3	3040244	3050676	3050680	5
63	5.8	8,6	10.5	3040245	3050686	3050690	3
75	6.8	10,3	12.5	3040246	3050695	3050699	2
90	8.2	12,3	15.0	3040247	3050704	3040269	2
110	10.0	15,1	18.3	3040248	3050712	3040270	1
125	11.4	17,1	20.8	3050719	3050721	3040271	1

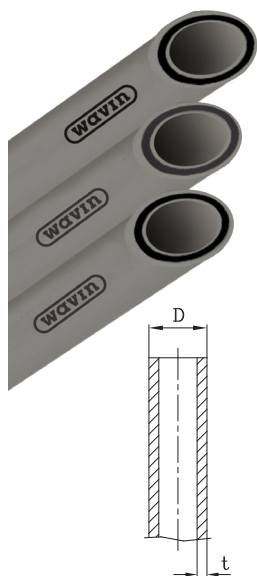

### Wavin GlassFiber Multilayer Pipe (PPR-4mt)

DN	t (mm) (20 Bar)	t (mm) (25 Bar)	s 3,2 SDR 7,4 PN 20	s 2,5 SDR 6 PN 25	Bundle
20	2.8	3.4	3052109	3052111	25
25	3.5	4.2	3052112	3052114	20
32	4.4	5.4	3052115	3052116	10
40	5.5	6.7	3052117	3052118	5
50	6.9	8.3	3052119	3085138	5
63	8.6	10.5	3052120	3085007	3
75	10.3	12.5	3052121	3085008	2
90	12.3	15.0	3052122	3085009	2
110	15.1	18.3	3052123	3085040	1
125	17.1	20.8	3052124	3085041	1

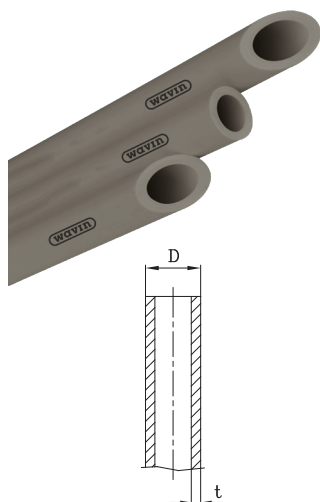

### Wavin PP-RCT (4mt)

DN	t (mm)	s 4 SDR 9 PN 22	Bundle
20	2,3	3065552	25
25	2,8	3065553	20
32	3,6	3065554	10
40	4,5	3065555	5
50	5,6	3065556	5
63	7,1	3065557	3
75	8,4	3065558	2
90	10,1	3065559	2
110	12,3	3065560	1
125	14	3065561	1

Wavin BasaltFiber Multilayer Pipe (PP- RCT -4mt)

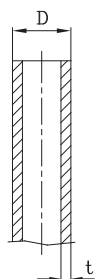

DN	t (mm)	s 4 SDR 9 PN 22	s 3,2 SDR 7,4 PN 25	Bundle
20	2.8		3052409	25
25	3.5		3052410	20
32	4.4		3052411	10
40	5.5		3052412	5
50	6.9		3052413	5
63	8.6		3052414	3
75	8.4	3052415		2
90	10.1	3052416		2
110	12.3	3052417		1
125	14.0	3052418		1

Socket

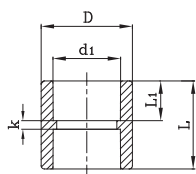

DN	Sap Code	Bag	Box	d (mm)	L1(min.) (mm)	D (mm)	L (mm)	k (mm)
20	3040349	50	600	19,50	14,50	28	33	4
25	3040350	40	400	24,50	16,00	34	37	4
32	3040351	20	240	31,50	18,00	42,5	41	4
40	3040352	15	120	39,40	20,50	53	46	4,5
50	3040353	10	100	49,40	23,50	66	52	4,5
63	3040354	6	48	62,50	27,50	83	60	4,5
75	3040355	6	30	74,70	30,00	100	65	5
90	3040356	1	24	89,20	33,00	120	71,5	6
110	3040357	1	10	109,00	37,00	146	80	6
125	3040358	1	10	124,60	40,00	167	86	6

Elbow (90°)

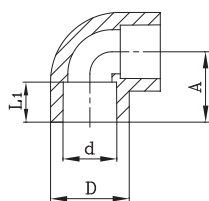

DN	Sap Code	Bag	Box	d (mm)	L1(min.) (mm)	D (mm)	A (mm)
20	3040127	50	450	19,5	14,5	28	25,5
25	3040128	50	300	24,5	16	33	29,5
32	3040129	25	150	31,5	18	43,5	35
40	3040130	10	80	39,4	20,5	53	41,5
50	3040131	5	40	49,4	23,5	67	50
63	3040132	5	25	62,5	27,5	83,5	60
75	3040133	3	15	74,7	30	100	68
90	3040134	1	8	89,2	33	120	78,5
110	3040135	1	4	109	37	147	92,5
125	3040136	1	4	124,6	40	168	102





**Elbow (45°)**

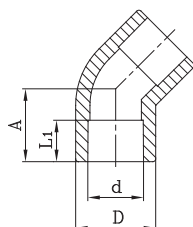

DN	Sap Code	Bag	Box	d (mm)	L1(min.) (mm)	D (mm)	A (mm)
20	3040119	50	400	19,5	14,5	26,5	20
25	3040120	50	250	24,5	16	33,5	22
32	3040121	20	120	31,5	18	43,5	32
40	3040122	10	100	39,4	20,5	52,5	31
50	3040123	8	48	49,4	23,5	68	35
63	3040124	4	24	62,5	27,5	84	42,5
75	3040125	3	18	74,7	30	100	47



**Elbow with Reducer**

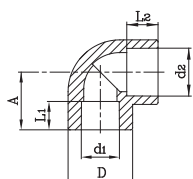

DN	Sap Code	Bag	Box	d1 (mm)	L1(min.) (mm)	d2 (mm)	L2(min.) (mm)	D	A
25-20	3051268	30	300	19,5	14,5	25	16	33	29,5



**Elbow (Female-Male) 90°**

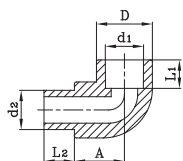

DN	Sap Code	Bag	Box	d1 (mm)	L1(min.) (mm)	d2 (mm)	L2(min.) (mm)	D (mm)	A (mm)
20	3040137	50	500	19,5	14,5	20	15	28,5	25
25	3040138	30	300	24,5	16	25	15,5	33,5	29,5
25/20	3040139	30	300	24,5	16	20	15,5	33	29,5



**Bend**

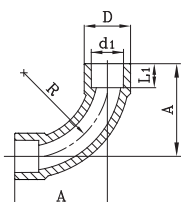

DN	Sap Code	Bag	Box	d1 (mm)	L1(min.) (mm)	D (mm)	L2(min.) (mm)	L (mm)
25	3085003	20	180	24,5	16	35	63,5	88

**Tee**

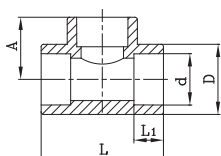

DN	Sap Code	Bag	Box	d (mm)	L1(min.) (mm)	D (mm)	L (mm)	A (mm)
20	3040177	30	240	19,5	14,5	27	51,5	26
25	3040178	25	150	24,5	16	33	63	30
32	3040179	15	90	31,5	18	43	72	36
40	3040180	5	50	39,4	20,5	53	85	43,5
50	3040181	4	32	49,4	23,5	66,5	100	50
63	3040182	3	18	62,5	27,5	84,5	119,5	60
75	3040183	2	12	74,7	30	100	130	73
90	3040184	1	6	89,2	33	120	158	79
110	3040185	1	4	109	37	146	186	93
125	3040186	1	3	124,6	40	167	208	103,5

**Cross Tee**

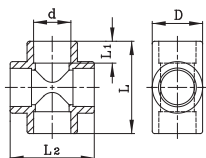

DN	Sap Code	Bag	Box	d (mm)	L1(min.) (mm)	D (mm)	L (mm)	L2 (mm)
20	3040109	25	200	19,5	14,5	26,5	51	51
25	3040110	15	150	24,5	16	33	60	60
32	3040111	10	90	31,5	18	42,5	70	70
40	3040112	5	50	39,4	20,5	53	84	84
50	3040113	3	24	49,4	23,5	66,5	103,5	103,5

**Manchon Union PN 10**

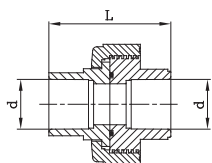

DN	Sap Code	Bag	Box	d (mm)	L (mm)
20	3040389	15	180	19,5	41
25	3040390	10	120	24,5	51
32	3040391	5	60	31,5	63
40	3040392	5	40	39,4	71
50	3040393	4	32	49,4	74

Unequal Tee

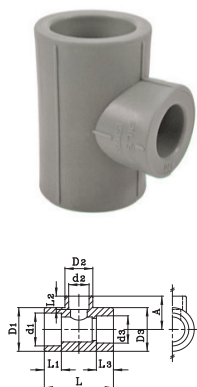

D1	D2	D3	Sap Code	Bag	Box	d1 (mm)	L1(min.) (mm)	D1 (mm)	d2 (mm)	L2(min.) (mm)	D2 (mm)	d3 (mm)	L3(min.) (mm)	D3 (mm)	L (mm)	A (mm)
20	25	20	3040274	25	150	19,5	14,5	33	24,5	16	33,5	19,5	14,5	33	65	37,5
25	20	20	3040275	25	150	24,5	16	35	19,5	14,5	28	19,5	14,5	28	53	27,5
25	20	25	3040277	25	150	24,5	16	33	19,5	14,5	26,5	24,5	16	33	55	28,5
25	25	20	3040276	25	150	24,5	18	33,5	24,5	16	33,5	19,5	14,5	33,5	65	35,5
32	20	20	3040279	15	90	31,5	18	42,5	19,5	14,5	42,5	19,5	14,5	42,5	73,5	40,5
32	20	25	3040282	15	90	31,5	18	43	19,5	14,5	42,5	24,5	16	43	73,5	40,5
32	20	32	3040278	15	90	31,5	18	42,5	19,5	14,5	27	31,5	18	42,5	60	31,5
32	25	20	3040283	15	90	31,5	18	42,5	24,5	16	42,5	19,5	14,5	42,5	73,5	40
32	25	25	3040281	15	90	31,5	18	43	24,5	16	43	24,5	16	43	66	40
32	25	32	3040280	15	90	31,5	18	43	24,5	16	34	31,5	18	43	103	35
32	50	32	3040284	4	32	31,5	18	65	49,4	23,5	65	31,5	18	65	65,5	54,5
40	20	40	3040285	5	50	39,4	20,5	53	19,5	14,5	33	39,4	20,5	53	70	38,5
40	25	40	3040286	5	50	39,4	20,5	53	24,5	16	33	39,4	20,5	53	70	38,5
40	32	40	3040287	5	50	39,4	20,5	53	31,5	18	43	39,4	20,5	53	80	41
40	50	40	3040288	4	32	39,4	20,5	66	49,4	23,5	65,5	39,4	20,5	66	103	54,5
50	20	50	3040293	4	32	49,4	23,5	66,5	19,5	14,5	33	49,4	23,5	66,5	85	44
50	25	50	3051242	4	32	49,4	23,5	66,5	24,5	16	33	49,4	23,5	66,5	85	44
50	32	32	3040294	4	32	49,4	23,5	66,5	31,5	18	65,5	31,5	18	66,5	103	55,5
50	32	40	3040296	5	50	49,4	23,5	66	31,5	18	65,5	39,4	20,5	66	103	54,5
50	32	50	3040297	4	32	49,4	23,5	65	31,5	18	51	49,4	23,5	65	90	49,5
50	40	32	3040295	4	32	49,4	23,5	66,5	39,4	20,5	66	31,5	18	66,5	103	55,5
50	40	40	3040289	4	32	49,4	23,5	66	39,4	20,5	65,5	39,4	20,5	66	104	55,5
50	40	50	3040290	4	32	49,4	23,5	65	39,4	20,5	52	49,4	23,5	65	90	49,5
50	50	32	3040298	4	32	49,4	23,5	66	49,4	23,5	66	31,5	18	66	103,5	55
50	50	40	3040291	4	32	49,4	23,5	65,5	49,4	23,5	65	39,4	20,5	65,5	103,5	54,5
63	20	63	3040299	2	20	62,5	27,5	84	19,5	14,5	26,5	62,5	27,5	84	80	52
63	25	63	3040300	2	20	62,5	27,5	84	24,5	16	33	62,5	27,5	84	85	52
63	32	63	3040301	2	20	62,5	27,5	84	31,5	18	42,5	62,5	27,5	84	91	52
63	40	63	3040302	2	20	62,5	27,5	83,5	39,4	20,5	53	62,5	27,5	83,5	101	54
63	50	63	3040303	2	20	62,5	27,5	83,5	49,4	23,5	66	62,5	27,5	83,5	112	57
75	20	75	3040304	1	12	74,7	30	100	19,5	14,5	33	74,7	30	100	130	60
75	25	75	3040305	1	12	74,7	30	100	24,5	16	33	74,7	30	100	130	60
75	32	75	3040306	1	12	74,7	30	100	31,5	18	53	74,7	30	100	130	60
75	40	75	3040307	1	12	74,7	30	100	39,4	20,5	53	74,7	30	100	130	60
75	50	75	3040308	1	12	74,7	30	100	49,4	23,5	83,5	74,7	30	100	130	68
75	63	75	3040309	1	12	74,7	30	100	62,5	27,5	83,5	74,7	30	100	130	68
90	75	90	3040310	1	8	89,2	33	120	74,7	30	120	89,2	33	120	158	79
110	90	110	3040311	1	4	109	37	146	89,2	33	146	109	37	146	186	93

Female-Female Reducer



DN	Sap Code	Bag	Box	d1 (mm)	L1 (min.) (mm)	d2 (mm)	L2 (min.) (mm)	D1 (mm)	D2 (mm)	L (mm)
25/20	3040312	30	300	24,5	16	19,5	14,5	35	32,5	39
32/20	3051246	25	250	31,5	18	19,5	14,5	43	41	48,5
32/25	3040313	25	250	31,5	18	24,5	16	43	41	48,5

**Female-Male Reducer**

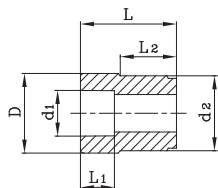

DN	Sap Code	Bag	Box	d1 (mm)	L1(min) (mm)	d2 (mm)	L2(min.) (mm)	D (mm)	L (mm)
25/20	3040315	40	560	19,5	14,5	25	18	29	39
32/20	3040317	30	300	19,5	14,5	32	13,5	35	39
32/25	3040316	30	300	24,5	16	32	15,5	35	39,5
40/20	3040318	30	240	19,5	14,5	40	25	30,5	47,5
40/25	3040319	30	240	24,5	16	40	24,5	35,5	48
40/32	3040320	20	200	31,5	18	40	27,5	42,5	47
50/20	3040321	20	200	19,5	14,5	50	23,5	29	48
50/25	3040322	25	200	24,5	16	50	23,5	34	49,5
50/32	3040323	15	150	31,5	18	50	23,5	42,5	47,5
50/40	3040324	10	120	39,4	20,5	50	24,5	53,5	48
63/25	3040325	10	120	24,5	16	63	28	34,5	56,5
63/32	3040326	10	120	31,5	18	63	28,5	43,5	57,5
63/40	3040327	5	80	39,4	20,5	63	28	63	53
63/50	3040328	5	60	49,4	23,5	63	28	67	53
75/50	3040329	5	50	49,4	23,5	75	31	75,5	61,5
75/63	3040330	5	40	62,5	27,5	75	26	84,5	67
90/63	3040331	4	36	62,5	27,5	90	28	91	76,5
90/75	3040332	2	24	74,7	30	90	33	98	81,5
110/63	3040333	1	18	62,5	27,5	110	32,5	111	88
110/75	3040334	1	18	74,7	30	110	32,5	111	91,5
110/90	3040335	1	18	89,2	33	110	32,5	119	93,5
125/110	3040336	1	13	109	37w	125	37	147	102

**Flange Adaptor**

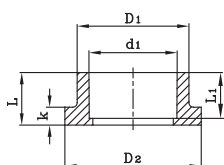

DN	Sap Code	Bag	Box	d (mm)	L1(min.) (mm)	D1 (mm)	D2 (mm)	L (mm)	k (mm)
40	3040196	25	250	39,4	20,5	50,5	62	24	8,5
50	3040197	15	150	49,4	23,5	61,5	73,5	27	8,5
63	3040198	10	80	62,5	27,5	77	90,5	31,5	8
75	3040199	4	36	74,7	30	90,5	106	38	16
90	3040200	4	36	89,2	33	109	124,5	42,5	18
110	3040201	2	20	109	37	132	150,5	50	21
125	3040202	1	12	124,6	40	164	185	62	20

**Saddle**

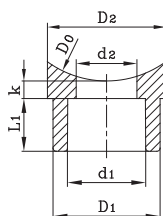

DN	Sap Code	Bag	Box	d0 (mm)	d1 (mm)	L1(min.) (mm)	d2 (mm)	D1 (mm)	D2 (mm)	k (mm)
63/20	3040337	50	600	63	19,5	14,5	17	28,5	37	6
63/25	3040338	50	600	75	19,5	14,5	17	28,5	37	6
75/20	3040339	50	600	90	19,5	14,5	17	28,5	37	6
75/25	3040340	50	600	110	19,5	14,5	17	28,5	37	6
90/20	3040341	50	600	63	24,5	16	19	33,5	37,5	6
90/25	3040342	50	600	75	24,5	16	19	33,5	37,5	6
110/20	3040343	50	600	90	24,5	16	19	33,5	37,5	6
110/25	3040344	50	600	110	24,5	16	19	33,5	37,5	6



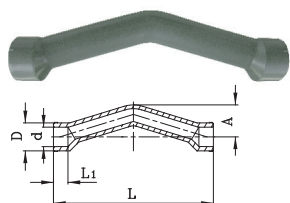

### Crossover Bridge

DN	Sap Code	Bag	Box	d1 (mm)	L1(min.) (mm)	D (mm)	L (mm)	A (mm)
20	3051244	15	150	19,5	14,5	28,5	160	33
25	3051245	10	100	24,5	16	33	194	40
32	4056717	4	56	31,5	18	46	216	49

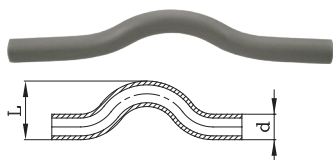

### Bridge

DN	Sap Code	Bag	Box	d (mm)	L (mm)
20	3040115	15	135	20	45
25	3040116	10	90	25	55
32	3040117	5	45	32	69
40	3040118	3	27	40	85

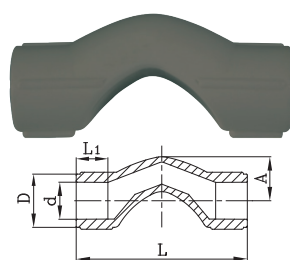

### Short Bridge

DN	Sap Code	Bag	Box	d (mm)	L1(min.) (mm)	D (mm)	A (mm)	L (mm)
20	4047832	30	240	19,5	14,5	28	23	90
25	4047833	25	150	24,5	16	33,5	31	96

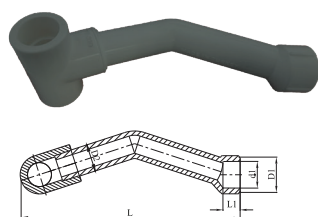

### Tee w/ V Type Bridge

DN	Sap Code	Bag	Box	d1 (mm)	L1(min.) (mm)	D1 (mm)	D2 (mm)	L (mm)
20/20/20	3075009	10	100	19,5	14,5	28	20	160
25/25/25	3075010	10	100	24,5	16	32,5	25	203
25/20/25	3075011	5	50	19,5	14,5	28	20	165
32/25/32	3075012	5	50	24,5	16	32,5	25	212

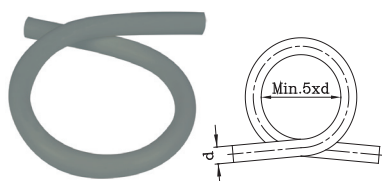

### Omega

DN	Sap Code	Bag	Box	d (mm)
20	3040105	5	25	20
25	3040106	3	15	25
32	3040107	1	8	32
40	3040108	1	4	40

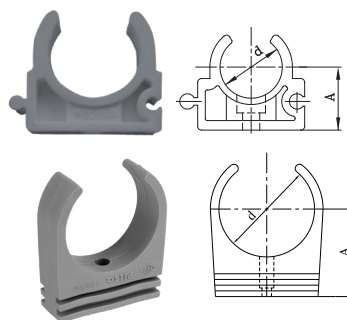

### Clips

DN	Sap Code	Bag	Box	d (mm)	A (mm)
20	3040232	100	1200	20,5	19
25	3040233	80	960	25,5	22
32	3040234	50	500	32,5	25
40	3040235	40	320	40,5	29
50	3040236	25	200	48,5	44

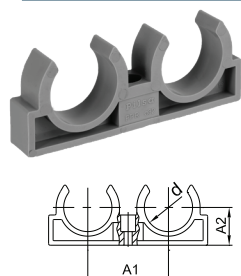

### Double Clips

DN	Sap Code	Bag	Box	d (mm)	A1 (mm)	A2 (mm)
20	3040237	50	500	20	38	17,5
25	3040238	40	320	25	44,5	19,5
32	3040239	25	200	32	53,5	25



**Manifold**

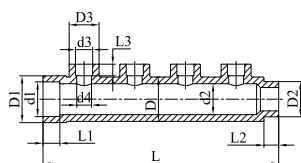

DN	Sap Code	d1 (mm)	L1 (mm)	D1 (mm)	D2 (mm)	L2 (mm)	d2 (mm)	d3 (mm)	D3 (mm)	L3 (mm)	d4 (mm)	D (mm)	L (mm)
50x25	3081246	49,4	23,5	66,5	50	21	44	24,5	42,5	16,0	21	63	335
50x32	3081550	49,4	23,5	66,5	50	21	44	31,5	42,5	18,0	28	63	335



**End Cap**

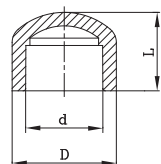

DN	Sap Code	Bag	Box	d (mm)	D (mm)	L (mm)
20	3040167	100	800	19,5	28,5	25,5
25	3040168	80	640	24,5	34,5	29
32	3040169	50	400	31,5	43	32
40	3040170	25	200	39,4	53,5	37,5
50	3040171	10	100	49,4	67	43,5
63	3040172	10	80	62,5	85	52
75	3040173	6	48	74,7	100,5	58
90	3040174	4	32	89,2	121	64
110	3040175	2	16	109	146,5	71,5



**Male Threaded End Cap**

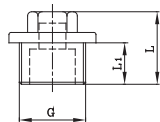

DN	Sap Code	Bag	Box	L1 (mm)	L (mm)	G (mm)
20x1/2	3040205	100	1000	11	34	1/2"
25x3/4	3040206	80	640	11	31	3/4"
32x1	3040207	50	400	20	40	1"



**Female Threaded Adaptor**

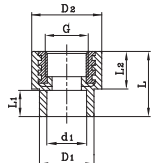

DN	Sap Code	Bag	Box	d1 (mm)	L1 (min) (mm)	D1 (mm)	D2 (mm)	L2 (mm)	L (mm)	G (mm)
20x1/2	3040024	20	320	19,5	14,5	28,5	38,5	24	40,5	1/2"
20x3/4	3040025	20	240	19,5	14,5	29	42,5	24	40	3/4"
25x1/2	3040026	25	250	24,5	16	33,5	38	24	40,5	1/2"
25x3/4	3040027	20	280	24,5	16	33	42,5	24	40,5	3/4"
32x3/4	3040028	10	120	31,5	18	43	45,5	24,5	44	3/4"
32x1	3040049	10	120	31,5	18	43	53	28	47,5	1"



**Female Threaded Adaptor (Hexagonal Shaped)**

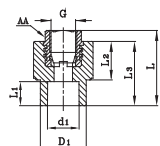

DN	Sap Code	Bag	Box	d1 (mm)	L1(min) (mm)	D1 (mm)	L2 (mm)	L3 (mm)	L (mm)	G (mm)
40x1 1/4	3040050	10	40	39,4	20,5	54	25,5	47	61	1-1/4"
50x1 1/2	3040051	4	24	49,4	23,5	68	29	53,5	67,5	1-1/2"
63x2	3040052	2	14	62,5	27,5	84	28,5	55	73	2"
75x2 1/2	3040053	2	12	74,7	30	100	30	59,5	78	2-1/2"
90x3	3040054	1	5	89,2	33	120,5	44	75,5	92	3"
110x4	3040055	1	4	109	37	147	48	84	102	4"



**Male Threaded Adaptor**

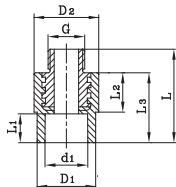

DN	Sap Code	Bag	Box	d1 (mm)	L1(min) (mm)	D1 (mm)	D2 (mm)	L (mm)	L2 (mm)	L3 (mm)	G (mm)
20x1/2	3040062	25	250	19,5	14,5	28,5	35	53	24	40	1/2"
20x3/4	3040063	20	200	19,5	14,5	29	42,5	53	23,5	40	3/4"
25x1/2	3040064	15	240	24,5	16	34	39	53	23,5	40	1/2"
25x3/4	3040065	15	150	24,5	16	33	42	53	24	40	3/4"
32x3/4	3040066	10	100	31,5	18	43	45	57	24,5	44	3/4"
32x1	3040067	10	100	31,5	18	43	52,5	62,5	28	47	1"



**Male Threaded Adaptor (Hexagonal Shaped)**

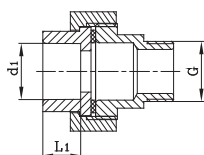

DN	Sap Code	Bag	Box	d1 (mm)	L1(min) (mm)	D1 (mm)	L2 (mm)	L3 (mm)	L (mm)	G (mm)
40x1 1/4"	3040068	5	25	39,4	20,5	54	25	47	81	1-1/4"
50x1 1/2"	3040069	2	16	49,4	23,5	68	29	53,5	87,5	1-1/2"
63x2"	3040070	1	10	62,5	27,5	84	28,5	55	98	2"
75x2 1/2"	3040071	1	6	74,7	30	100	30	59,5	105	2-1/2"
90x3"	3040072	1	5	89,2	33	120,5	43,5	76	118	3"
110x4"	3040073	1	3	109	37	147	48	84,5	129,5	4"



**Female Threaded Tee**

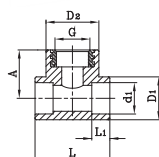

DN	Sap Code	Bag	Box	d1 (mm)	L1(min) (mm)	D1 (mm)	D2 (mm)	A (mm)	L (mm)	G (mm)
20x1/2	3040187	25	200	19,5	14,5	27	38,5	35	51,5	1/2"
20x3/4	3040188	20	140	19,5	14,5	28,5	43	36	60,5	3/4"
25x1/2	3040189	20	120	24,5	16	33	38	37	60	1/2"
25x3/4	3040190	15	120	24,5	16	35	43	37,5	60	3/4"
32x1	3040191	10	70	31,5	16	43	53,5	43	70	1"



**Male Threaded Tee**

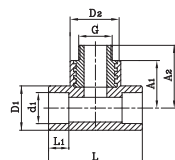

DN	Sap Code	Bag	Box	d1 (mm)	L1(min) (mm)	D1 (mm)	D2 (mm)	A1 (mm)	A2 (mm)	L (mm)	G (mm)
20x1/2	3040208	15	150	19,5	14,5	27	38,5	35	47,5	51,5	1/2"
20x3/4	3040209	10	130	19,5	14,5	28,5	43	36,5	49,5	60,5	3/4"
25x1/2	3040210	10	100	24,5	16	33	38	37	50,5	60	1/2"
25x3/4	3040211	10	100	24,5	16	35	43	37,5	50,5	60	3/4"
32x1	3040212	10	60	31,5	16	43	53,5	43	58	70	1"



**Female Threaded Elbow**

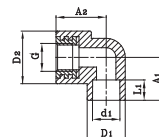

DN	Sap Code	Bag	Box	d1 (mm)	L1(min) (mm)	D1 (mm)	D2 (mm)	A1 (mm)	A2 (mm)	G (mm)
20x1/2	3040142	25	250	19,5	14,5	28,5	38,5	31,5	36	1/2"
20x3/4	3040143	20	280	19,5	14,5	29	40	31	35,5	3/4"
25x1/2	3040144	20	160	24,5	16	33,5	38,5	32	38	1/2"
25x3/4	3040145	15	180	24,5	16	33,5	43	32	40	3/4"
32x3/4	3040146	10	100	31,5	18	44	57,5	34	45	3/4"
32x1	3041449	10	100	31,5	18	43,5	54	34	45	1"



**Male Threaded Elbow**

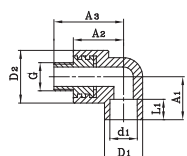

DN	Sap Code	Bag	Box	d1 (mm)	L1(min) (mm)	D1 (mm)	D2 (mm)	A1 (mm)	A2 (mm)	A3 (mm)	G (mm)
20x1/2	3040154	25	200	19,5	14,5	28,5	38,5	31,5	36	49	1/2"
20x3/4	3040155	10	180	19,5	14,5	29	40	31	36	48	3/4"
25x1/2	3040156	10	140	24,5	16	33,5	38,5	32	38	51	1/2"
25x3/4	3040157	20	160	24,5	16	33,5	43	32	40	53	3/4"
32x3/4	3051239	10	80	31,5	18	43,5	57,5	34,5	45	58	3/4"
32x1	3040158	10	80	31,5	18	43,5	54	34,5	45	62	1"



**Underplaster Female Elbow**

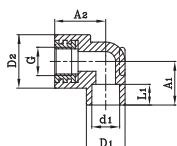

DN	Sap Code	Bag	Box	d1 (mm)	L1(min) (mm)	D1 (mm)	D2 (mm)	A1 (mm)	A2 (mm)	G (mm)
20	3040384	20	200	19,5	14,5	28	38,5	31	35	1/2"
25	3040385	15	180	24,5	16	33	38,5	31,5	36	1/2"



**Underplaster Male Elbow**

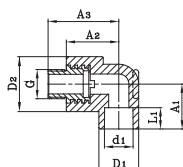

DN	Sap Code	Bag	Box	d1 (mm)	L1(min) (mm)	D1 (mm)	D2 (mm)	A1 (mm)	A2 (mm)	A3 (mm)	G
20	3040387	15	180	19,5	14,5	28	38,5	31	35	48	1/2"
25	3040388	10	180	24,5	16	33	38,5	31	36	49	1/2"



**Adjustable Underplaster Female Elbow**

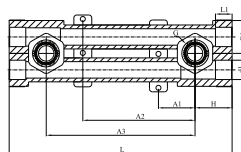

DN	Sap Code	Bag	Box	d1 (mm)	L1(min) (mm)	D1 (mm)	A1 (mm)	A2 (mm)	A3 (mm)	L (mm)	H (mm)	G (mm)
20x1/2	3040081	3	36	19,5	14,5	33	37	113	150	224	38	1/2"
25x1/2	4064856	3	36	24,5	16,5	33	37	113	150	224	38	1/2"



**Double Stable Underplaster Female Elbow**

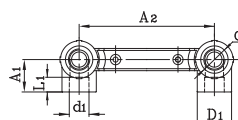

DN	Sap Code	Bag	Box	d1 (mm)	L1(min) (mm)	D1 (mm)	A1 (mm)	A2 (mm)	G
20x1/2	4047838	5	60	19,5	14,5	34	32	150	1/2"
25x1/2	4047839	5	60	24,5	16	34	32	150	1/2"





**Bide Nozzle Part Female**

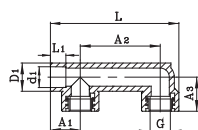

DN	Sap Code	Bag	Box	d1 (mm)	L1(min) (mm)	D1 (mm)	A1 (mm)	A2 (mm)	A3 (mm)	L (mm)	G (mm)
20x1/2	3051266	10	60	19,5	14,5	27	28,5	90	32	136	1/2"

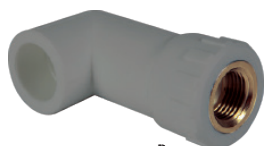

**Elbow Long**

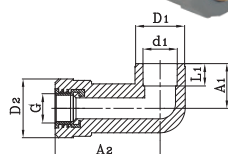

DN	Sap Code	Bag	Box	d1 (mm)	L1(min) (mm)	D1 (mm)	D2 (mm)	A1 (mm)	A2 (mm)	G (mm)
25x1/2	4049357	25	150	24,5	16	35	42	32	75	1/2"



**Valve**

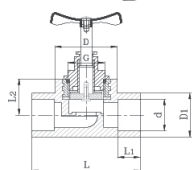

DN	Sap Code	Bag	Box	d1 (mm)	L1(min) (mm)	D1 (mm)	D (mm)	A (mm)	L (mm)	G (mm)
20	3078894	5	70	19,5	14,5	28	38	26	72	1/2"
25	3078897	5	70	24,5	16	33	42	30	77	3/4"
32	3078920	3	42	31,5	18	42,5	53	39	80	1"
40	3040292	3	30	39,4	20,5	54	64	43	111	1-1/4"



**Ball Valve**

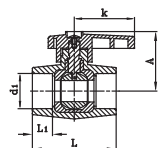

DN	Sap Code	Bag	Box	d (mm)	L1(min) (mm)	A (mm)	k (mm)	L (mm)
20	3079033	5	120	19,5	14,5	50	56	68
25	3079034	5	120	24,5	16	50	56	68
32	3079035	5	80	31,5	18	54	56	75



40	3070085	4	48	39,4	20,5	71	119	89
50	3070086	2	28	49,4	23,5	78	119	12
63	3070087	1	15	62,5	27,5	90	157	128
75	3070088	1	12	74,7	30	100	157	148

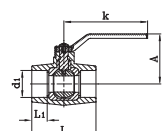

**Chrome Valve**

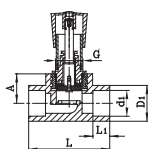

DN	Sap Code	Bag	Box	d1 (mm)	L1(min) (mm)	D1 (mm)	A (mm)	L (mm)	G (mm)
20	3072159	1	60	19,5	14,5	28,5	26,5	72	3/4"
25	3040102	1	60	24,5	16	33,5	30	77	3/4"
32	3040103	1	50	31,5	18	42,5	39	80	1"

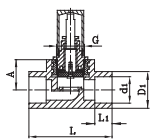

**Valve Round Cap**

DN	Sap Code	Bag	Box	d1 (mm)	L1(min) (mm)	D1 (mm)	A (mm)	L (mm)	G (mm)
20	3072165	1	60	19,5	14,5	28,5	26,5	72	3/4"
25	3052748	1	60	24,5	16	33,5	30	77	3/4"
32	3052749	1	50	31,5	18	43	38,5	80,5	1"

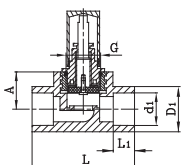

**Decorative Valve**

DN	Sap Code	Bag	Box	d1 (mm)	L1(min) (mm)	D1 (mm)	A (mm)	L (mm)	G (mm)
20	3072162	1	60	19,5	14,5	28,5	26,5	72	3/4"
25	3051254	1	60	24,5	16	33,5	30	77	3/4"
32	3051255	1	50	31,5	18	42,5	39	80	1"

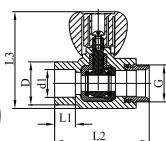

**Radiator Valve Straight**

DN	Sap Code	Bag	Box	d1 (mm)	L1(min) (mm)	D (mm)	L2 (mm)	L3 (mm)	G (mm)
20	4047847	5	80	19,5	14,5	30	66	68	3/4"

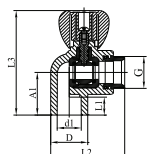

**Radiator Valve Elbow**

DN	Sap Code	Bag	Box	d1 (mm)	L1(min) (mm)	D (mm)	A1 (mm)	L2 (mm)	L3 (mm)	G (mm)
20	4047846	5	80	19,5	14,5	30	34,5	60	85	3/4"

**Metal Female Threaded Union (Hexagonal Shaped)**

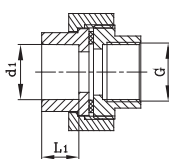

DN	Sap Code	Bag	Box	d (mm)	L1(min.) (mm)	G (mm)
20x1/2"	3040217	10	120	19,5	14,5	1/2"
25x3/4"	3040218	10	80	24,5	16	3/4"
32x3/4"	3040219	5	60	31,5	18	3/4"
32x1"	3040220	5	60	31,5	18	3/4"
40x1 1/4"	3040221	2	24	39,4	20,5	1-1/4"
50x1 1/2"	3040222	2	24	49,4	23,5	1-1/2"
63x2"	3040223	2	18	62,5	27,5	2"

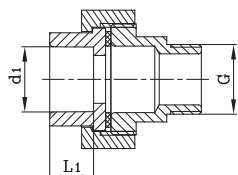
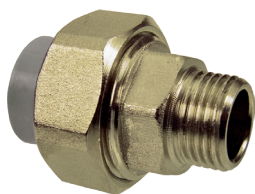

**Metal Male Threaded Union (Hexagonal Shaped)**

DN	Sap Code	Bag	Box	d (mm)	L1(min.) (mm)	G (mm)
20x1/2"	3040224	10	120	19,5	14,5	1/2"
25x3/4"	3040225	10	80	24,5	16	3/4"
32x3/4"	3040226	5	50	31,5	18	3/4"
32x1"	3040227	5	50	31,5	18	1"
40x1 1/4"	3040228	2	24	39,4	20,5	1-1/4"
50x1 1/2"	3040229	2	20	49,4	23,5	1-1/2"
63x2"	3040230	2	16	62,5	27,5	2"

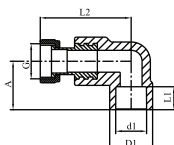
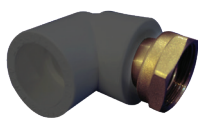

**Shifting Elbow with Metal Transition**

DN	Sap Code	Bag	Box	d1 (mm)	L1(min) (mm)	D1 (mm)	A1 (mm)	L2 (mm)	G (mm)
20x1/2	3040164	30	300	19,5	14,5	28,5	30	45	1/2"
25x3/4	3040165	25	250	24,5	16	33,5	33	53	3/4"

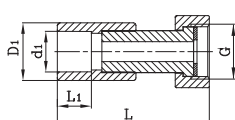

**Shifting Union with Metal Transition**

DN	Sap Code	Bag	Box	d1 (mm)	L1 (min) (mm)	D1 (mm)	L (mm)	G (mm)
20x1/2	4047821	30	300	19,5	14,5	28,5	57	1/2"
20x3/4	4047822	25	250	19,5	14,5	29	59	3/4"
25x1/2	4047823	25	250	24,5	16	33,5	59	1/2"
25x3/4	4047824	25	250	24,5	16	33	59	3/4"
25x1	4065369	20	200	24,5	16	42,5	72	1"

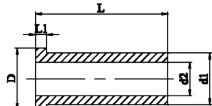
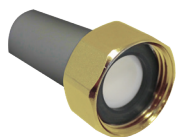

**Shifting Union With Plastic Transition**

DN	Sap Code	d1 (mm)	D2 (mm)	D (mm)	L (mm)	L1 (mm)
25x1	3081758	25,0	16,2	29,8	64,5	5,4

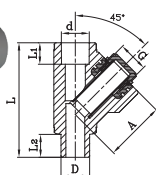
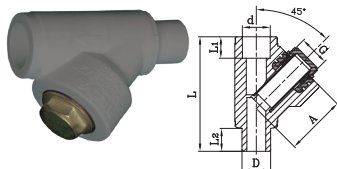

**Strainer Y with Filter**

DN	Sap Codes	Bag	Box	d1 (mm)	L1 (min) (mm)	D (mm)	D2 (mm)	L (mm)	G (mm)
20x1/2	3040203	20	200	19,5	14,5	30	41	80	1/2"
25x3/4	3040204	10	120	24,5	16	35	46	101,5	3/4"

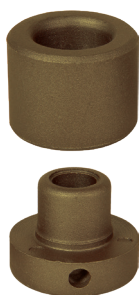

**Welding Head**

DN	Sap Code	Box
20	3033427	50
25	3033428	50
32	3033429	50
40	3033430	50
50	3033431	50
63	3033432	30
75	3033433	30
90	3033434	30
110	3033435	20
125	3033436	10



**Cutter**

DN	Sap Code	Box
20-25-32	3033042	30
40-63	4047816	20



**Welding Machine Set**

DN	Sap Code	Box
16-40	3033236	5
50-110	3040363	1



# Our Certificates



# Discover our broad portfolio at [www.wavin.com.tr](http://www.wavin.com.tr)

- Hot&Cold Water
- Indoor Climate Solutions
- Urban Climate Resillience
- Waste Water Drainage
- Water and Gas Distribution
- Foul Water

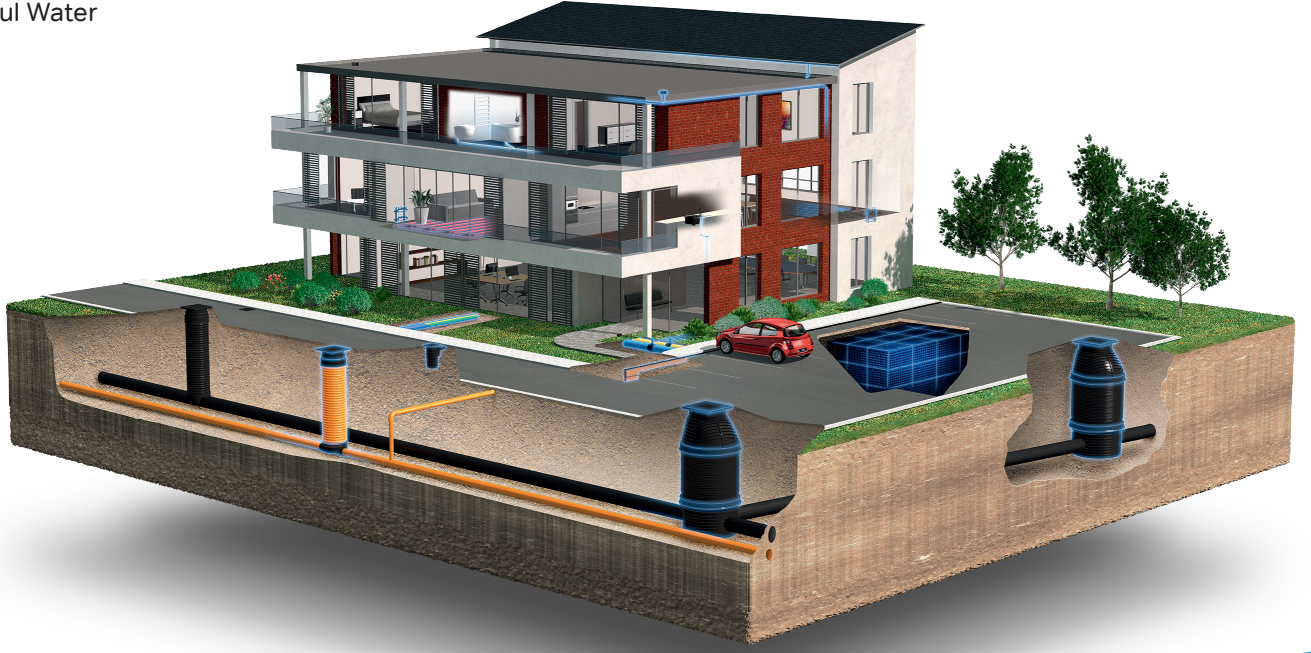

**wavin**

**orbia** 

Wavin is part of Orbia, a community of companies working together to tackle some of the world's most complex challenges.

We are bound by a common purpose:  
To Advance Life Around the World.

Wavin TR Plastik Sanayi A.Ş. | Güzelevler Mah.Girne Bulvarı No: 294/A Yüreğir / Adana  
Web [www.wavin.com.tr](http://www.wavin.com.tr) | E-mail [wavin.tr.info@wavin.com](mailto:wavin.tr.info@wavin.com)

Wavin operates a programme of continuous product development, and therefore reserves the right to modify or amend the specification of their products without notice. All information in this publication is given in good faith, and believed to be correct at the time of going to press. However, no responsibility can be accepted for any errors, omissions or incorrect assumptions.

© 2022 Wavin | Wavin reserves the right to make alterations without prior notice. Due to continuous product development, changes in technical specifications may change. Installation must comply with the installation instructions.