

Hot and Cold Water Systems

Wavin Tigris K1
Wavin Tigris M1
Wavin smartFIX





Contents

1. Wavin Multi-Layer Composite Pipe	Page	4
2. Wavin Tigris K1 Press Fitting System	Page	6
3. Wavin Tigris M1 Press Fitting System	Page	8
4. Wavin smartFIX Push-Fitting System	Page	10
5. Installation and Assembly Information	Page	12

The Tigris Hot and Cold Water System 1 pipe - 3 types of fittings

The flexible pipe system for all hot & cold water and heating applications.

Which type of fitting you use is entirely up to you.

1. Wavin Multi-Layer Composite Pipe

Three Wavin fitting types are designed for use with one Wavin multi-layer composite pipe. Wavin Tigris K1, Wavin Tigris M1 and Wavin smartFIX use either Press-fit or Push-fit technology.

All three systems fulfil the requirements for hot and cold water installations and radiator heating systems. They meet all drinking water quality requirements and are physiologically harmless.

1.1. The Wavin multi-layer composite pipe

The Wavin multi-layer composite pipe for plumbing and heating comprises an internal cross-linked polyethylene layer (PE-Xc), an external layer in PE and an intermediate butt welded aluminium layer. The three layers are uniformly connected together by means of bonding agents. This produces a pipe structure with a total of five layers.

As well as being diffusion-proof, the uniform plastic-metal construction offers additional advantages:

- ⦿ The pipe is dimensionally stable, resistant to unwanted movement yet flexible.
- ⦿ With easy bending, the installation is easy and time required can be reduced to a minimum.
- ⦿ The permanent connection of the plastic pipes to the aluminium pipe means that the length expansion is determined by the metal. It is roughly equal to that of copper, i.e. it is minimal (see page 20 for more information).

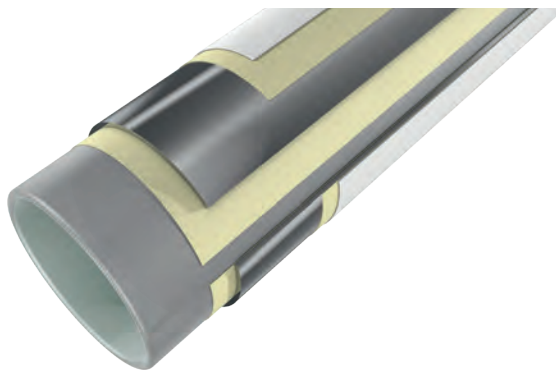

Figure 1: Multi-layer composite pipe structure.

Advantages in practice:

- ⦿ Low weight
- ⦿ Dimensions from 16 mm to 63 mm
- ⦿ Significantly fewer fittings needed due to the ease of pipe bending and long pipe coils
- ⦿ Easy bending with dimensional stability is ideal for tight installation situations
- ⦿ Quick and safe assembly
- ⦿ Diffusion-proof
- ⦿ Suitability for all water qualities
- ⦿ Free of encrustation
- ⦿ Physiologically harmless
- ⦿ Corrosion resistant
- ⦿ Minimum length expansion
- ⦿ Pressure and temperature resistant

1.2. Technical specifications

Wavin multi-layer composite pipe

Pipe material	Internal layer is electron-beam crosslinked polyethylene (PE-Xc), external layer is PE, with an aluminium layer between, connected by special bonding agents
Pipe colour	White
Max. constant operating temperature*	85°C
Max. shortterm load**	100°C
Max. constant operating pressure	10 bar (where T _{max.} = 70°C)
Coefficient of thermal expansion	0.025 – 0.030 mm/m K
Thermal conductivity	0.4 W/m K
Pipe roughness	0.007 mm

* At a max. operating pressure of 6 bar.

** At max. 100 hours in 50 years.

1.3. The Wavin multi-layer composite pipe for radiator heating and underfloor heating

The Wavin multi-layer composite pipe can be used for both radiator and floor heating systems. Being 100% resistant to oxygen diffusion, temperature resistant, supple and flexible, it offers outstanding properties for all types of heating installations.

Aluminium thickness

The aluminium layer in the Wavin pipe is manufactured using butt-welding technology. This gives a secure aluminium layer with no variation in thickness of the aluminium or the finished pipe and ensures a reliable seal when the pipe is connected to the fittings.

Corrosion resistance

The plastic internal and external layers offer minimal surface friction for water as a result of their low roughness. Deposits and corrosion are things of the past.

It can be safely used in mixed installations as there is no risk of electrochemical corrosion. Moreover, the plastic outer sheath allows embedding of the Wavin multi-layer composite pipe directly in the screed.

Limited length expansion

The internal aluminium layer has a decisive effect on the thermal length expansion of the composite pipe. As a result of the permanent connection with the plastic layers, the length expansion is determined by the expansion co-efficient of the aluminium layer and therefore roughly equal to that of a metal pipe.

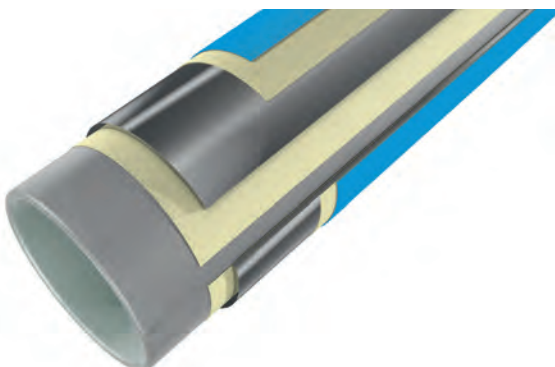

1.4. Additional protective measures

Thermal overloading of the composite pipe network must be avoided by taking appropriate safety precautions including the use of suitably regulated equipment and monitoring equipment.

Protection from UV radiation

The plastic outer sheath of the composite pipe provides adequate protection from indirect UV radiation inside buildings and no further measures are required. However, the pipes must not be constantly subjected to direct UV radiation (solar radiation outdoors) without suitable protective sheathing.

Installation

The Wavin pipe can be handled by a single installer. Optimal aluminium thickness means it can be bent by hand for pipes up to 20 mm diameter. Bending springs and bending pliers may be used to assist and should always be used for diameters 25 mm and above. Furthermore, the Wavin pipe can be installed with the polymer fittings from the Wavin Tigris K1 press fitting range and the Wavin smartFiX push-fit fitting system. It can equally be used with the metal fittings of the Tigris M1 press fitting range.

Accessories and Tools

The pipe ends must be calibrated and de-burred using the Wavin calibration tool. The pipe can then safely be inserted and connected to all three Wavin fittings types i.e. Tigris K1, Tigris M1 and smartFiX.

2. Wavin Tigris K1 Press Fitting System

2.1. PPSU Wavin Tigris K1 press fitting with defined leak function

The Wavin Tigris K1 press fitting is made of the high technical performance plastic polyphenylsulfone (PPSU), which is resistant to high temperatures (heat shape resistance > 200 °C, processing temperature 360°C), corrosion and encrustation. Its extremely high notched impact strength and lack of sensitivity to stress cracks make the fitting extremely robust and insensitive to impacts. The performance of PPSU has already been proven over many years in aircraft engineering, medical sterilisation technology, chemical plants and automotive engineering as well as in Wavin plumbing fittings.

The fittings are equipped with a fixed stainless steel press sleeve. The sleeve gives the connection additional strength and reliability. It has an observation window, through which the insert depth of the pipe can be reliably checked before pressing. The seal is with an O-ring.

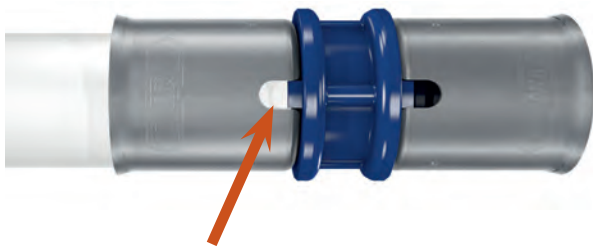

Figure 2: The observation window in the stainless steel press sleeve can be used to check that the pipe is inserted to the stop.

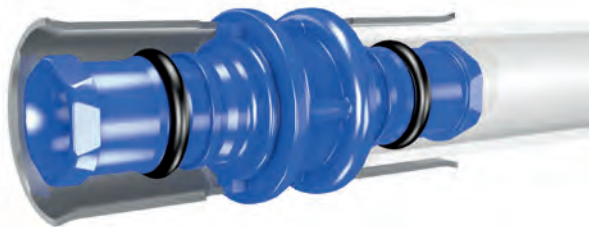

Figure 3: The new generation of PPSU press fittings with hexagonal head cross-section.

Wavin has more than 140 different K1 press fittings in its range, including threaded transition fittings. In the case of externally threaded fittings, you have the choice between pure PPSU fittings and fittings in dezincification resistant brass. Internally threaded fittings have an insert in dezincification resistant brass. In order to avoid stress cracking corrosion, all brass components undergo a special follow-up treatment.

The new generation of PPSU press fittings guarantees that an accidentally unpressed connection is unsealed and reliably exposed by leaking during the pressure test. Furthermore, the new hexagonal head cross-section reduces the force required to insert the pipe, which makes the work of the installer easier. The new fitting design is patented.

2.2. Range of applications

Wavin Tigris K1 meets the requirements for tap water installation and radiator heating systems. The pipe system is suitable for all tap water qualities and is physiologically harmless.

Wavin Tigris K1 is therefore suitable for hot and cold water installations and for radiator heating in residential construction as well as in public and commercial buildings. Thanks to an extensive range of fittings, the system is optimally suited not only to new construction but also to renovations of old buildings.

Figure 4: Safety through clever technology: the Defined Leak Function in the pressure test reveals unpressed fitting connections.



Advantages in practice:

- ⤵ Can be combined with Tigris M1 and smartFiX
- ⤵ Dimensions from 16 mm to 63 mm
- ⤵ Low insertion forces due to the patented Wavin hexagonal head shape
- ⤵ Intended leak function (unpressed = unsealed)
- ⤵ Quick and safe assembly
- ⤵ Physiologically harmless
- ⤵ Suitable for any water quality

2.3. Approvals and Certificates

Wavin Tigris K1 is subject to constant internal quality controls and continuous external monitoring.

Wavin Tigris K1 is approved by DVGW.



and certified to EN-ISO 21003

2.4. Technical specifications

Wavin Tigris K1

Pipe material (for multi-layer composite pipes see pages 7 and 8)	Internal layer in electron-beam cross-linked polyethylene (PE-Xc), external layer in PE, with an aluminium layer between, connected by special bonding agents
Fitting material	Polyphenylsulfone (PPSU), press sleeve in stainless steel
Pipe colour	White
Fitting colour	Wavin Tigris K1: blue
Max. constant operating temperature*	85°C
Max. short-term load**	100°C
Max. constant operating pressure	10 bar (where Tmax. = 70°C)
Coefficient of thermal expansion	0.025 – 0.030 mm/m K
Thermal conductivity	0.4 W/m·K
Pipe roughness	0.007 mm

* At a max. operating pressure of 6 bar.

** At max. 100 hours in 50 years.

3. Wavin Tigris M1 Press Fitting System

3.1. Wavin Tigris M1 metal press fitting with defined leak function

The Tigris M1 system is an addition to the range from Wavin. Based on the patented Tigris K1 design with the hexagonal head cross-section, Wavin now offers a system for installers who prefer to use metal fittings.

The Wavin Tigris M1 metal press fitting is resistant to high temperatures, corrosion and encrustation.

The fittings are equipped with a fixed stainless steel press sleeve. The sleeve gives the connection additional strength and reliability. It has an observation window, through which the insert depth of the pipe can be reliably checked before pressing. The seal is with two O-rings.

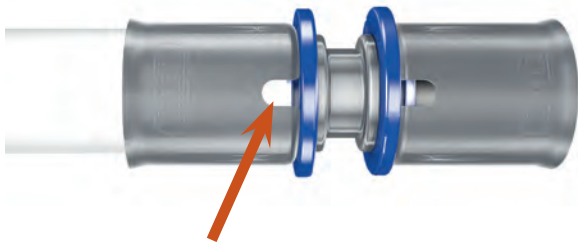

Figure 5: The observation window in the stainless steel press sleeve can be used to check that the pipe is inserted to the stop



Figure 6: The new generation of metal press fittings with hexagonal head cross-section.

Available in diameters 16 to 63 mm. The new generation of metal press fittings guarantees that an accidentally unpressed connection is unsealed and reliably exposed in the pressure test. Furthermore, the new hexagonal head cross-section has a positive impact on reducing the insertion forces with reduces the force required to insert the pipe. The new fitting design is patented.

3.2. Range of applications

Wavin Tigris M1 meets the requirements for tap water installation and radiator heating systems. The pipe system is suitable for all tap water qualities and is physiologically harmless.

Wavin Tigris M1 is therefore suitable for cold and hot water installations and for radiator heating in residential construction as well as in public and commercial buildings. Thanks to an extensive range of fittings, the system is optimally suited not only to new construction but also to renovations of old buildings.

Figure 7: Safety through clever technology: the leak function in the pressure test reveals unpressed fitting connections.



Advantages in practice:

- ⤵ Can be combined with Tigris K1 and smartFiX
- ⤵ Dimensions from 16 mm to 63 mm
- ⤵ Low insertion forces due to the patented Wavin hexagonal head shape
- ⤵ Defined leak function (unpressed = unsealed)
- ⤵ Quick and safe assembly
- ⤵ Physiologically harmless
- ⤵ Suitable for any water quality

3.3. Approvals and Certificates

Wavin Tigris M1 is subject to constant internal quality controls and continuous external monitoring.

Wavin Tigris M1 is approved by DVGW.



and certified to EN-ISO 21003.

3.4. Technical specifications

Wavin Tigris M1

Pipe material (for multi-layer composite pipes see pages 7 and 8)	Internal pipe in electron-beam cross-linked polyethylene (PE-Xc), external pipe in PE, with an aluminium layer between, connected by special bonding agents
Fitting material	Tinned brass, press sleeve in stainless steel
Colour	Pipes in white
Fitting colour	Wavin Tigris M1: base body silver and blue fix ring
Max. constant operating temperature*	85°C
Max. short-term load**	100°C
Max. constant operating pressure	10 bar (where Tmax. = 70°C)
Coefficient of thermal expansion	0.025 – 0.030 mm/m·K
Thermal conductivity	0.4 W/m·K
Pipe roughness	0.007 mm

* At a max. operating pressure of 6 bar.

** At max. 100 hours in 50 years.

4. Wavin smartFiX Push-Fit Fitting System

4.1. The push-fit fitting installation system Wavin smartFiX

As a push-fit fitting system, Wavin smartFiX stands out for its quick, tool-free processing.

4.2. System description

4.2.1. Multi-layer composite pipe system with PPSU Wavin smartFiX push-fit fitting

Like Wavin Tigris K1 and Wavin Tigris M1, Wavin smartFiX is also designed for universal use in plumbing and heating installations. All three systems are fully compatible with each other. Wavin smartFiX is available in sizes from 16 to 25 mm.

4.3.2. PPSU push-fit fitting

The base body of the push-fit fitting and the fixing ring are made of the high technical performance plastic polyphenyl-sulfone (PPSU), which is resistant to high temperatures (heat shape resistance > 200°C, processing temperature 360°C), corrosion and encrustation. The caps are produced in glass fibre reinforced polyamide.

The extremely high notched impact strength and lack of sensitivity to stress cracks make the fitting robust and insensitive to impacts. The performance of PPSU has already been proved over many years in aircraft engineering, medical sterilisation technology, chemical plants and automotive engineering as well as in Wavin plumbing fittings.

The smartFiX fittings have an observation window, through which the insert depth of the pipe can be checked. The seal is with a dry-coated O-ring, which contributes to minimising the insertion forces. The helps make the fitting tolerant to site conditions, for example dust and debris.

Wavin has more than 55 different smartFiX push-fit fittings in its range, including threaded transition fittings. In the case of externally threaded fittings, you have the choice between pure PPSU fittings and fittings in dezincification resistant brass. Internally threaded fittings have an insert made from dezincification resistant brass. In order to avoid stress cracking corrosion, all brass components undergo a special follow-up treatment.

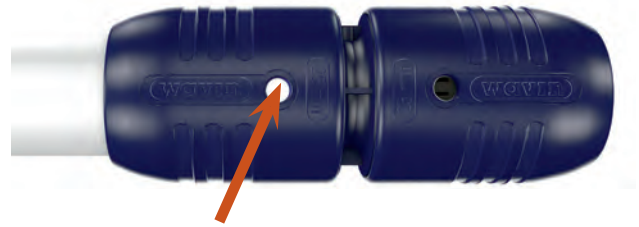

Figure 8: The observation window in the PPSU cap can be used to check that the pipe is inserted to the stop.

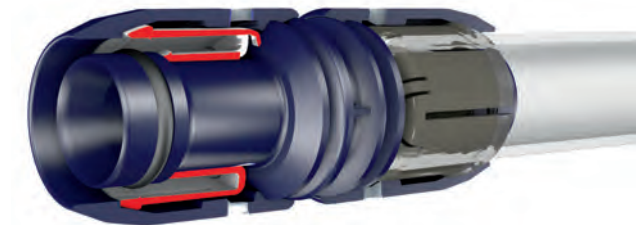

Figure 9: The smartFiX push-fit fitting.

4.3. Range of applications

Wavin smartFiX meets the requirements for tap water installation and radiator heating systems. The pipe system is suitable for all tap water qualities and physiologically harmless.

Wavin smartFiX is therefore suitable for cold and hot water installations and for radiator heating in residential construction as well as in public and commercial buildings.

Wavin smartFiX is a complete installation pipe system. It lends itself particularly where quick and safe installation is required at the same time as minimisation of expenses for installation tools.

Advantages in practice:

- ⤵ Compatible with Tigris K1 and Tigris M1
- ⤵ Dimensions from 16 mm to 25 mm
- ⤵ Uncomplicated, quick push-fit connection technology
- ⤵ Low insertion forces required
- ⤵ Minimum tooling quick and safe assembly
- ⤵ Physiologically harmless
- ⤵ Suitable for any water quality

4.4. Approvals and Certificates

Wavin smartFIX is subject to constant internal quality controls and continuous external monitoring.

Wavin smartFIX is approved by DVGW.



and certified to EN-ISO 21003.

4.5. Technical specifications

Wavin smartFIX

Pipe material (for multi-layer composite pipes see pages 7 and 8)	Internal pipe in electron-beam cross-linked polyethylene (PE-Xc), external pipe in PE, with an aluminium layer between, connected by special bonding agents
Fitting material	Polyphenylsulfone (PPSU) for the fitting base body and fixing ring. Caps in glass fibre reinforced polyamide
Pipe Colour	White
Fitting colour	Blue
Max. constant operating temperature*	85°C
Max. short-term load**	100°C
Max. constant operating pressure	10 bar (where Tmax. = 70°C)
Coefficient of thermal expansion	0.025 – 0.030 mm/m K
Thermal conductivity	0.4 W/m·K
Pipe roughness	0.007 mm

* At a max. operating pressure of 6 bar.

** At max. 100 hours in 50 years.

5. Installation and Assembly Information

5.1. Storage and handling

The Wavin system components are well protected in the original packaging. Nonetheless, all components (fittings and pipes) should be protected from mechanical and environmental damage.

5.2. Impairment due to ultraviolet radiation

Wavin multi-layer composite pipes must be protected from direct, intense sunlight and ultraviolet (UV) radiation. This applies both for the storage of the pipes and for finished installation. Storage must therefore not take place in the open air. Suitable measures must be taken to protect finished systems and system components from the effects of UV rays.

5.3. Observe press and push-fit fitting assembly instructions

- ⦿ Always cut the pipe to length at right angles
- ⦿ Calibrate and chamfer the pipe end all round
- ⦿ Push the pipe into the fitting to the stop
- ⦿ Check the press or push-fit fitting observation window
- ⦿ Press in the case of the press fittings
- ⦿ See pages 16 et seq. for detailed installation and assembly information

5.4. Potential equalisation

Building and electrical regulations such as VDI 0190 parts 410 and 540 demand potential equalisation between earth wires and “conductive” water, wastewater and heating pipes. As Wavin Hot and Cold Water Systems do not represent conductive pipe systems, they cannot be used for potential equalisation and are accordingly not to be earthed. An approved electrician must check that the installation of Wavin Tigris K1/M1 and Wavin smartFIX does not impair the existing electrical protective and earthing measures.

5.5. Installation temperature

The installation temperature for Wavin pipe systems should not fall below -10°C.

The operating temperatures of the new pressing machines with the Li-ion batteries from the Wavin range must be above -15°C nor above 40°C. The optimum processing range for Wavin Tigris K1/M1 and Wavin smartFIX system components lies roughly between 5°C and 25°C.

5.6. Frost protection

When using Wavin Hot and Cold Water Systems with pipe networks that require protection from frost (e.g. cold water networks, brine pipes), we recommend the use of ethylene glycol (to protect from risk of freezing). Ethylene glycol can be used up to a maximum concentration of 35%. This concentration roughly corresponds to frostproofing of -22°C. Before using alternative frost protection additives, confirm the suitability/approval with the manufacturer or with Wavin.

5.7. Sealing

The assembly of a threaded connection must be in accordance with DIN 30 660. We strongly recommend the use of PTFE / Teflon Tape to seal the connection. Alternatively hemp may be used but only in conjunction with an approved plastic sealing compound such as Fermit. Restrict the amount of hemp as too great a quantity can result in damage to the internal threads and cross-threading. When using hemp make sure that the thread tips remain visible.

5.8. Contact with substances containing solvents

Avoid direct contact of Wavin Hot and Cold Water Systems with solvents or construction materials containing solvents (such as paints, sprays, expanding foams, adhesives).

Note:

Specifically chemical sealants (e.g. Loctite) and adhesives (e.g. 2-part adhesives) must not be used.

Expanding foams produced on the basis of methacrylate, isocyanate and acrylate must not be used.

Under unfavourable circumstances, aggressive chemicals that are present may cause damage to the plastic material.

The Wavin systems do not require the use of any chemical substance or additional lubrication during installation.

5.9. Pipe preparation and assembly

Tigris K1, Tigris M1, smartFIX

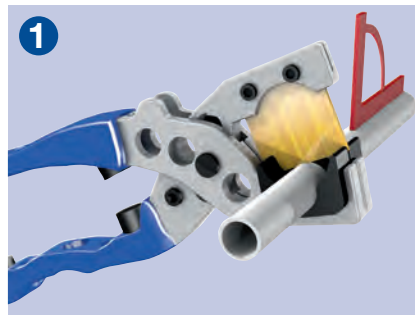

Tigris K1

Tigris M1

smartFIX

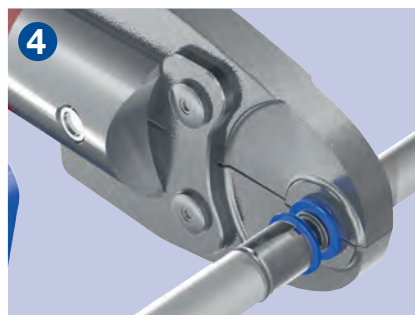
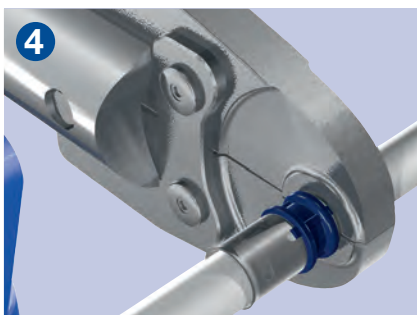
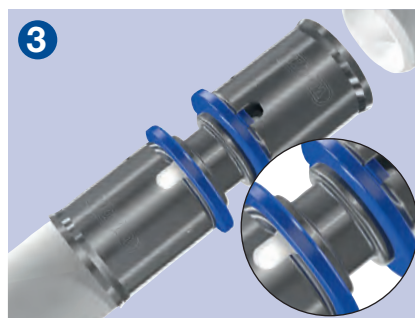
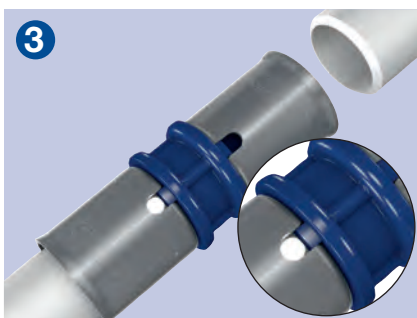



- ① Combination cutters (with pipe holder) for the dimension 16 – 25 mm
- ① Pipe cutter for the dimension 32 – 63 mm



- ① Dimensions 16 – 25 mm: all-round chamfer of depth min. 1 mm
- ① Dimensions 32 – 63 mm: all-round chamfer of depth min. 2 mm
- ① Max. battery or drilling machine rotation speed should be 500 rpm
- ① Remove accumulated shavings from the battery calibrating pin
- ① smartFIX: If one end of the pipe is already connected to the fitting, the opposite end should not be calibrated without resistance, to avoid the pipe rotating in the fitting



- ① Push the pipe into the fitting to the stop

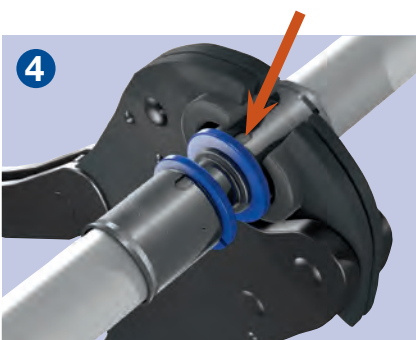

Tigris K1 and Tigris M1 only

- ① The pressing jaws must be positioned on the inner stop of the press sleeve
- ① The pressing process may be executed only once per connection

5.10. Assembly instructions

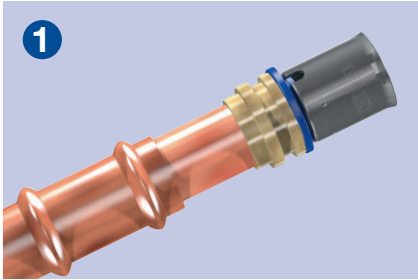

5.10.1. Assembly instructions for K1 press transition to copper

- ④ Slide the press connection into the copper fitting and press according to the specifications of the copper fitting manufacturer. A minimum space of 5 mm must be observed between the soldered joint and outer edge of the copper fitting

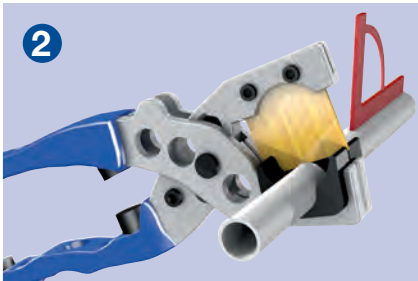

- ④ Cut multi-layer composite pipes of dimensions 16 – 25 mm to length at right angles with the combination scissors



- ④ After deburring, an all-round chamfer of at least 1 mm (Da 16 – 25) must be visible
- ④ The maximum rotation speed when using the calibrator on the battery or drilling machine is 500 rpm. After use, remove accumulated shavings from the battery calibrating pin

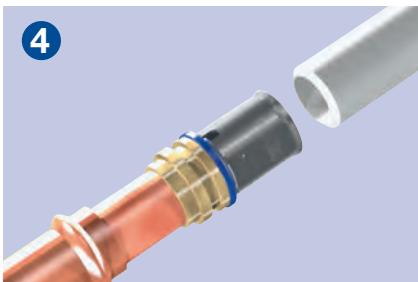

- ④ Push the pipe into the fitting to the stop

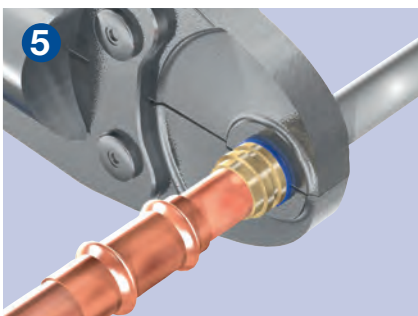

- ④ The pressing jaws must be positioned on the inner stop of the press sleeve
- ④ The pressing process must be executed only once per connection.

Attention: Do not solder, otherwise the sealing rings on the press transition to copper may be damaged



5.10.2. Assembly instructions for smartFIX push-fit transition to copper

- ① Cut the copper pipe to length at right angles

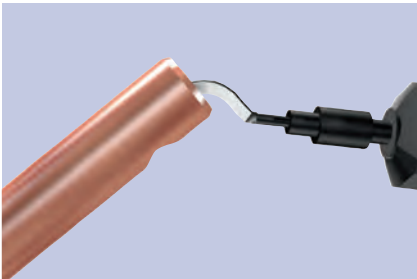

- ② Carefully deburr the copper pipe inside and outside
Soft copper pipe must be calibrated



- ③ Check the transition coupling for cleanness and correct sitting of the sealing elements. Push the transition coupling onto the copper pipe as far as it will go. Do not use oil or any lubrication here

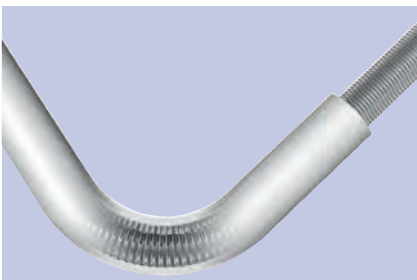

5.11. Bending Wavin multi-layer composite pipes

The pipe is easy to bend: by hand, with the aid of the bending spring or using the Wavin bending pliers.

Measurement Da x s mm	Bending radius By hand mm	Bending radius Bending spring mm
16 x 2,0	5 x $\varnothing \approx 80$	4 x $\varnothing \approx 64$
20 x 2,25	5 x $\varnothing \approx 100$	4 x $\varnothing \approx 80$
25 x 2,5	5 x $\varnothing \approx 125$	4 x $\varnothing \approx 100$
32 x 3,0	-	-
40 x 4,0	-	-
50 x 4,5	-	-
63 x 6,0	-	-

* Smaller bending radii using our bending pliers.

Table1: Minimum bending radii with and without aids*.

5.12. Installation and Assembly Information

The respective current codes of practice must be observed in the installation of Wavin Tigris K1, Tigris M1 and smartFiX Hot and Cold Water Systems. These systems are to be assembled only by trained and qualified professionals.

5.12.1. Installation and fixing

5.12.1.1. Basics

Wavin Tigris K1, Tigris M1 and smartFiX Hot and Cold Water Systems are constructed in accordance with the relevant codes of practice. The mountings used must be adequate for fixing the composite pipe in the respective nominal diameter. Fixing systems with a sound insulation insert are recommended.

The expected length expansion based on maximum temperature feed and line length must be taken into account. A distinction is generally drawn between fixed points and floating points as fixing methods. Fixed points divide the pipeline element into separate sections. In the case of straight pipe routes, a fixed point is to be applied at the mid-point. No fixed points should be applied directly at fittings that are used for a change of direction.

Sufficient stability of the fixed points is required in order to effectively absorb the expansion forces occurring. A short distance to the ceiling must be observed.

Vertical lines, e.g. such as risers, can generally be installed only with fixed point clips. Here, fixing should be in front of or behind each storey branch. By contrast, floating point fixings guarantee expansion and movement of the pipeline concerned. For more information about this, please refer to the next chapter.

5.12.1.2. Consideration of thermally induced length expansion

All pipe materials expand on heating and contract on cooling. In the case of the piping for tap water systems (particularly with heated tap water) and heating pipes, the temperature-based length expansion of the materials must always be taken into account.

The temperature difference and pipe length constructed determine the length change. On assembly, the movement possibilities for each direction change must be taken into account.

Irrespective of the pipe size, the coefficient of expansion of Wavin multi-layer composite pipes is 0.025 – 0.030 mm/m·K.

The length changes of Wavin multi-layer composite pipes as expected in operation with different pipe lengths and temperature differences can be determined from the following diagram.

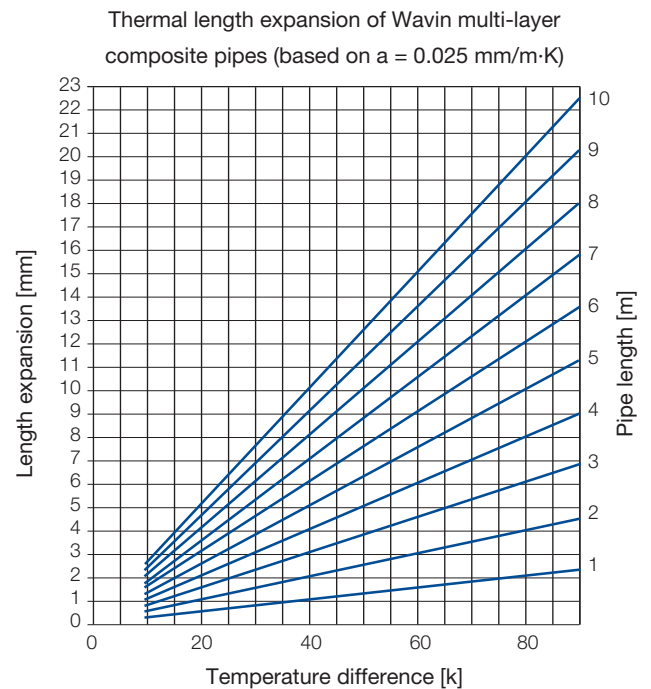

Figure 10: Length changes of Wavin multi-layer composite pipes.

The length changes can likewise be calculated using the following formula:

	$\Delta l = a \times l \times \Delta q$ Δl = Length expansion (mm) a = Coefficient of length expansion (mm/m.K) l = Pipeline length (m) Δq = Temperature difference (K)
Sample calculation: Given:	Wavin Tigris K1 hot water pipe Pipe length (l) 12 m Lowest ambient temperature 10 °C Medium temperature 60 °C
Sought:	Maximum length expansion under operating conditions $\Delta l = a \times l \times \Delta q$ $60 \text{ k} - 10 \text{ k} = 50 \text{ k}$ $0,025 \text{ mm/m.K} \times 12 \text{ m} \times 50 \text{ K} = 15 \text{ mm}$
Result:	Maximum length expansion under operating conditions = 15 mm

5.12.1.3. Absorption of length changes by bending joints

In the case of a change of direction, the thermal length expansion of a pipeline can often be offset within the pipe layout by bending joints and expansion U-bends.

The length of the bending joint can be determined by calculation or taken from the diagram below.

$$L_B = C \sqrt{d \cdot \Delta L}$$

Key:

L_B = Length of the bending joint	[mm]
d = External pipe diameter	[mm]
ΔL = Length change	[mm]
C = Material-dependent constant for Wavin multi-layer composite pipe	(= 30)

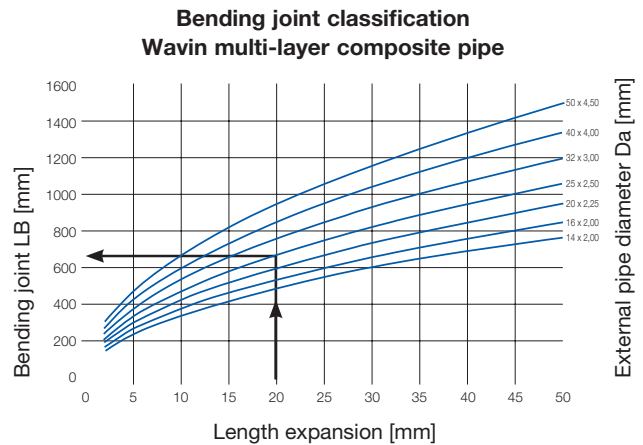
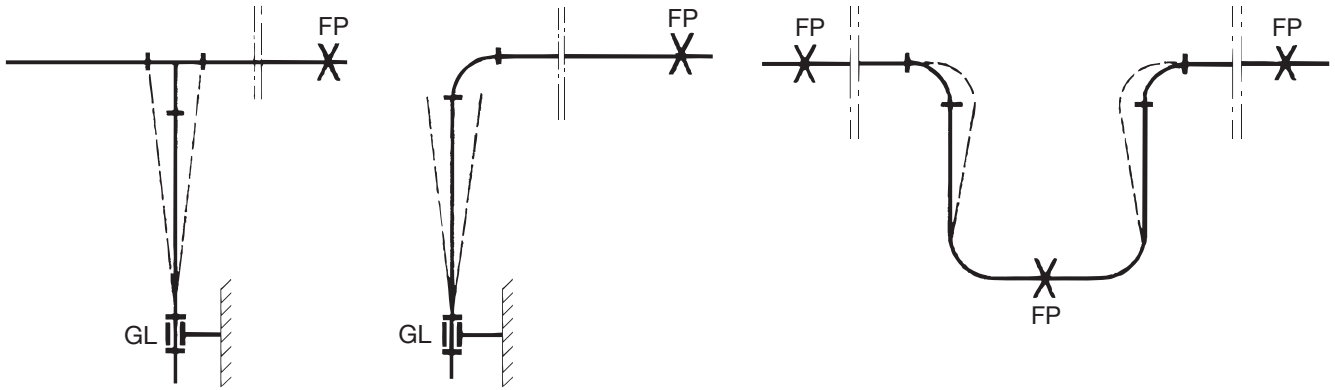

Figure 11: Bending joint classification of Wavin multi-layer composite pipes.

Sample calculation:

Given:	Length change = 20 mm Pipe diameter $d = 25 \times 2.5 \text{ mm}$ Constant c for Tigris K1/M1/smartFIX = 30
Sought:	Length of the bending joints L_B
Result	650 mm, from diagram above



FP = Fixed point
GL = Floating point

Figure 12: Floating and fixed point mountings.

5.12.1.4. Fixing intervals

Pipelines on a supporting base must be fixed in accordance with DIN 18560 part 2, section 4.1.

The number of fixing components is essentially dependent on the piping in the respective construction project. As the calculation basis with straight piping, a fixing component can be attached at approx. 1 m pipe length. In the areas of diversions, at least two fixing components are to be affixed (before and after the diversion curve).

Because of their dimensional stability, Wavin multi-layer composite pipes installed in exposed locations require no supporting aids e.g. such as a supporting shell or support tube. They can be fixed at the intervals specified in the following table.

Dimension mm	Fixing interval m
16 x 2,0	1,00
20 x 2,25	1,20
25 x 2,5	1,50
32 x 3,0	1,50
40 x 4,0	1,80
50 x 4,5	1,80

Table 2: Pipe clamp intervals for Wavin multi-layer composite pipes installed in exposed locations.

The type and intervals of the attachments/fixings are dependent on pressure, temperature, medium and installation situation. The pipe attachments/fixings must be properly designed according to the total mass (pipe weight + weight of the water + weight of the insulation), in accordance with the recognised codes of practice.

Dimension mm	Pipe mass kg/m	Pipe mass + water kg/m	Pipe mass + water + Iso 9 mm kg/m	Pipe mass + water + Iso 13 mm kg/m
16 x 2,00	0,095	0,202	0,232	0,250
20 x 2,25	0,138	0,330	0,364	0,384
25 x 2,50	0,220	0,558	0,596	0,620
32 x 3,00	0,340	0,942	0,988	1,012
40 x 4,00	0,605	1,605	-	-
50 x 4,50	0,840	2,480	-	-

Table 3: Pipe masses.

5.12.1.5. Pipes in screed or concrete

Due to the relatively low expansion forces, no compensation measures are required in the case of direct embedding of the pipes. Because of the slight plastic malleability of Wavin multi-layer composite pipes, the length changes are absorbed by the pipe wall. Moreover, the respective requirements for heat protection (see the energy saving regulation section in this handbook) and impact noise insulation must be observed.

5.12.1.6. Pipes in the floor construction

As multi-layer composite pipes can move axially within the insulation with little resistance, the expected length changes must be absorbed. Right angle diversions in the insulating layer must be arranged such that length changes that occur in the respective sections are absorbed by the insulation thickness in the curve area.

Wavin Hot and Cold Water Systems already laid in the ground are exposed to many potential impacts on site during the construction phase, from scaffolding, ladders or other objects. Damage to the pipe/fitting or even the insulation must be avoided. Before installing further floor construction, a check should therefore be conducted for damage. Any damage to the pipe insulation should be repaired in all cases in order to avoid the risk of the formation of impact noise bridges or reduced sound insulation (see also the section on sound insulation in this handbook).

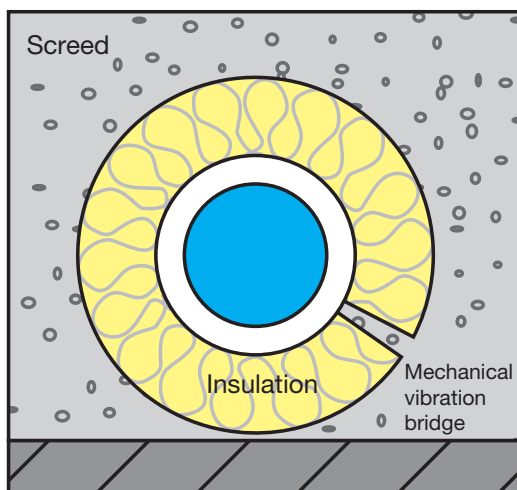

Figure 13: Mechanical vibration transmission through defective pipe insulation.

Causes of damage in floating screeds are often due to several pipe strings installed under the screed plate.

The following principles should be observed when installing pipe strings in the floor construction:

- ⦿ Use heat and sound insulated pipelines
- ⦿ Use sound insulated pipe fixing.
- ⦿ Avoid pipe crossings as much as possible
- ⦿ Pipeline installation parallel to walls
- ⦿ Perpendicular junctions of pipelines into neighbouring walls
- ⦿ Maximum width of the pipe string 120 mm
- ⦿ Minimum distance between pipelines and walls: 200 mm in corridors, 500 mm in the living area
- ⦿ Piping through screed expansion joints with corrugated tube or alternatively with 6 mm pipe insulation

5.12.1.7. Pipelines installed under plaster

Depending on the wall construction and masonry strength, there is a risk that the expansion forces from a multi-layer composite pipe that is plastered in directly will cause damage to the wall.

Multi-layer composite pipes under plaster should therefore be installed with insulation. This pipe insulation must be able to absorb expected length changes due to heat. In the case of pipelines under plaster for which there is no need for heat insulation, we recommend the use of the Wavin multi-layer composite pipe in black protective tube (see product range).

All pipes and fittings installed under plaster must be protected from direct contact with all building materials (such as masonry, plaster, cement, screed, tile adhesive) as detailed above.

5.12.1.8. Pipelines installed in exposed locations

Pipelines installed in exposed locations (e.g. basement pipes, risers etc) are fixed depending on the structural conditions and the recognised codes of practice. As appropriate, thermal length changes must be taken into account with the arrangement of bending joints in conjunction with fixed points and floating points (see section 5.12.2.2.).

5.12.1.9. Installation variants for drinking water

5.12.1.9.1. Tee installation

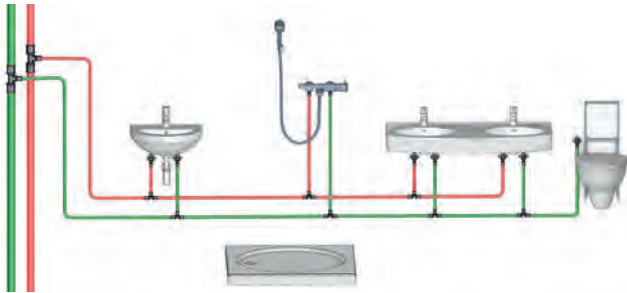

Example 1: Traditional distribution system, using individual Tee fittings to connect to each tap.

This type of installation should be used only when supplying to regularly and frequently used taps and fittings. Regularly and frequently here means “daily”. Tee connections result in single supply lines in which the drinking water can stagnate if it is not used.

Advantages:

- Simple piping
- Quick to install
- Less piping used

5.12.1.9.2. In-series installation

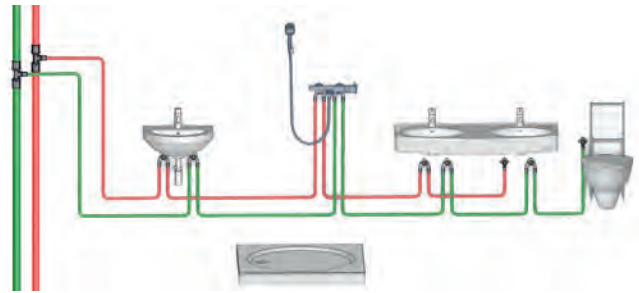

Example 2: In-series installation; loop-through up to the last fixture.

In-series installation is suited to multi-storey installation with upstream water meters. The pipe is routed from one tapping point directly to the next using double connections. The tapping points are supplied by a common pipe. It should be ensured that the most frequently used fixture appears at the end of the in-series installation. WC flushing systems that can be set with a continuous, timed flush are available. These ensure that the entire cold-water piping on each storey is flushed even when not in continuous use, for example in hotels. If required, flush valves for hot water piping are also available, with which a continuous, timed flush can be set.

Advantages:

- Simple piping
- No joints in screed
- Time-saving, quick installation
- Even pressure and heat distribution
- Low stagnation volume
- Rapid water exchange

5.12.1.9.3. Loop installation

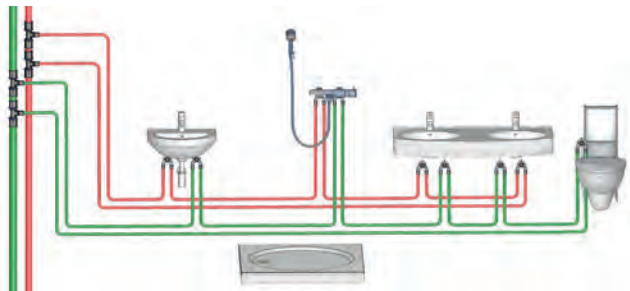

Example 3: Loop installation; loop-through up to the last fixture and then return to the storey connection point.

The loop installation illustrated here is suited to multi-storey installation with upstream water meters. The pipe is routed from one tapping point directly to the next using double connections. The piping then runs from the last consumer back to the storey connection point.

Advantages:

- ⦿ Low pressure loss values (reduced by 50%)
- ⦿ Significantly more tapping points can be connected with the same pipe diameter
- ⦿ Greater distances for tapping are possible
Even pressure and heat distribution
- ⦿ Optimum water exchange with just one consumer's use
- ⦿ Low stagnation times

5.12.1.9.4. Loop installation with circulation connection

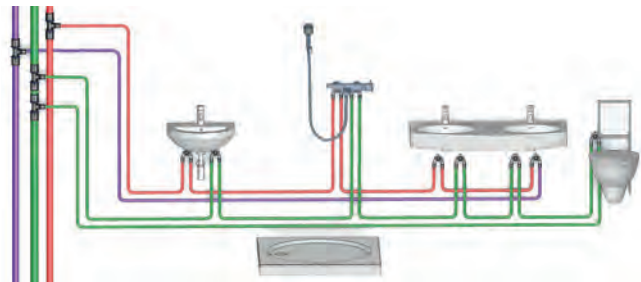

Example 4: Loop installation with separate circulation.

This type of loop installation is suitable for multi-storey installations without upstream water meters. The pipe is guided from one tapping point directly to the next using double connections. The piping then runs from the last cold water consumer back to the storey connection point. The hot water pipe is guided from the last fixture as a circulation pipe back to the storey connection point.

Advantages:

- ⦿ Lower pressure loss values for cold water section
- ⦿ All hot water tapping points feature a circulation connection. Even hot water temperature distribution
- ⦿ Optimum water exchange even when only one fixture is used
- ⦿ Low stagnation times
- ⦿ No legionella growth in the hot water tapping points
- ⦿ Hydraulic alignment of the circulation piping

5.12.1.9.5. Internal circulation

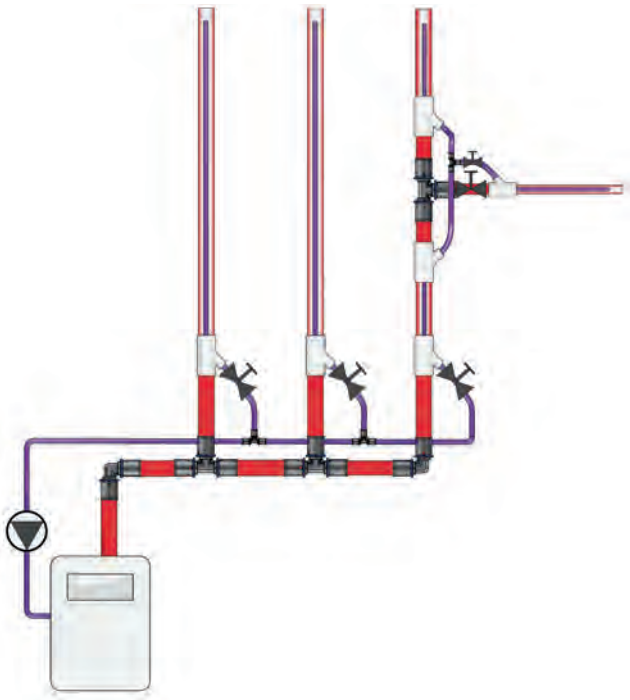

Fig. 14: The principle of internal circulation through an entire drinking water installation.

Internal circulation is an efficient installation type offering various advantages. Basically, the circulation piping feeds into the hot water piping.

Advantages:

- ⊕ Less space required in the duct
- ⊕ No separate fixings
- ⊕ No separate insulation
- ⊕ No separate fire protection. Less material required
- ⊕ No additional loss of energy through external circulation
- ⊕ Optimum hygiene
- ⊕ Can be retrofitted into existing installations (depending on standing pipe dimension)

Tip: Internal circulation: quick, energy-efficient, can be retrofitted.

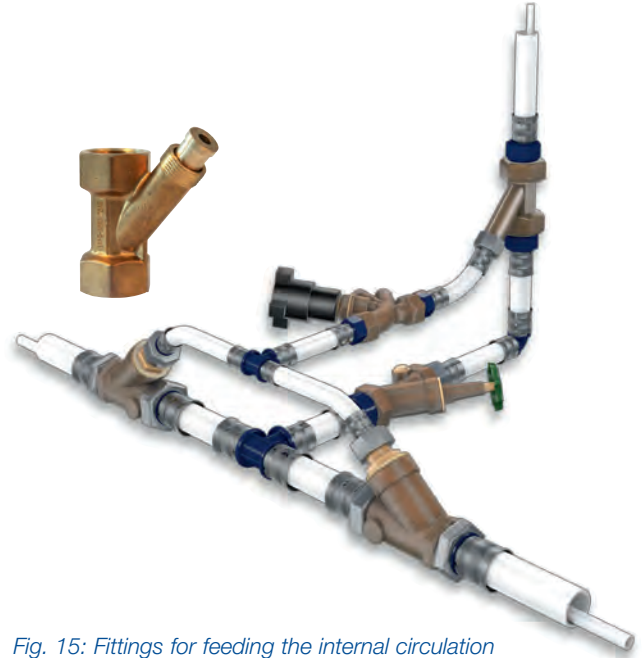

Fig. 15: Fittings for feeding the internal circulation into the existing pipework and pre-assembled connection sets for distribution in the storey.

Wavin offers pre-assembled connection sets for internal circulation. The Wavin connection sets comprise:

- ⊕ Wavin internal circulation pipe PE-Xc, in 8 mm or 12 mm.
- ⊕ Wavin multi-layer composite pipe.
- ⊕ Tigris K1 and Tigris M1 pre-form parts (incl. pre-form parts with sleeve as transition to internal circulation pipe).
- ⊕ Thermostat valve with default setting for circulation piping.
- ⊕ Phase regulation and isolation valve.

Note for calculating the size:

With internal circulation, the selected existing pipe generally has to be one size bigger than the calculation. The Wavin connection set is available on request.

Tigris Inliner connection sets	Cat. code
40 x 32 mm	03171473
50 x 32 mm	03171474

Individual parts	Cat. code
Tigris Inliner pipe PE-Xc 8 mm	03171472
Tigris Inliner pipe PE-Xc 12 mm	03171471
Tigris M1 Inliner fitting 1" x 3/4" 8 mm	03171469
Tigris M1 Inliner fitting 1 1/2" x 3/4" 12 mm	03171470

5.12.1.10. Heating installation variants

1. Double pipe heating

The “standard variant” – recognised, tried and tested

Economically sensible terms and conditions of service

Because of the total length of the pipe network resulting in pressure loss, a pressure loss of 100 to 200 Pa/m can be calculated in consideration of additional individual resistances (e.g. valves).

The advantages:

- ⦿ Even temperature of all radiators (= source of well being)
- ⦿ Recognised system for recording heating costs
- ⦿ Typical for old building renovation
- ⦿ Suitable for skirting boards

2. Double pipe heating with central manifold

The “spaghetti system” – optimal assembly and comfort

Economically sensible terms and conditions of service

Because of the short connection pipes from the manifold to the individual radiators, a pressure loss of 240 to 400 Pa/m can be calculated in consideration of additional individual resistances (e.g. valves).

The advantages:

- ⦿ Only one pipe dimension from the manifold
- ⦿ No connecting points in the floor area
- ⦿ Each radiator feed line can be operated autonomously.
- ⦿ No circulation in the pipe system in case of radiator stoppage (energy saving)

3. Single pipe heating

The “saving variant” – quick and inexpensive

Economically sensible terms and conditions of service

Because of the total length of the main line resulting in pressure loss in the case of single pipe heating, a pressure loss of 100 to 200 Pa/m should be expected in consideration of additional individual resistances (sub-pipes branching off of the main line or z values of 4-way valves).

With the use of 4-way valves:

- ⦿ No connecting points in the floor area
- ⦿ Extremely quick installation
- ⦿ Only one pipe dimension from the line connection

5.13. Radiator connection: installation variants

The Wavin Tigris K1/M1 and smartFIX systems offer many options for the connection of standard compact and valve radiators in the single pipe and double pipe system. The following diagrams show the most popular connection variants. In all cases, the insulation must be taken into account in accordance with the energy saving regulation.

5.13.1. Compact radiators

1. Pipe connection from the wall by means of IT “Eurocone” screw connections.

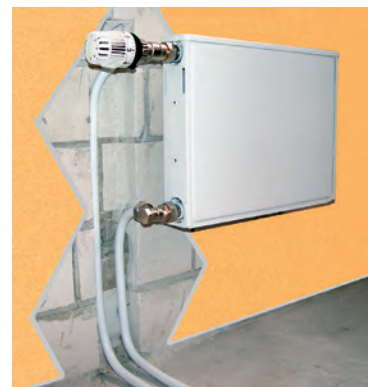

Tigris K1 IT screw connections

“Eurocone”

16 x 3/4”

20 x 3/4”

5.13.2. Valve radiators

1. Pipe connection from the wall by means of radiator connecting block and IT “Eurocone” screw connections and the use of a junction fitting.

2. Pipe connection from the floor by means of Tigris K1 angle connecting pipes.

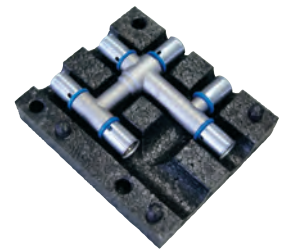
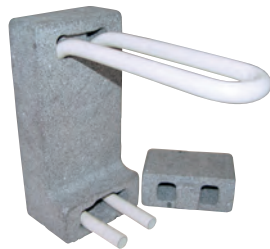

Tigris K1
IT screw connections
“Eurocone”
16 x 3/4”
20 x 3/4”

Radiator connecting blocks

Vario radiator connecting block

Tigris K1 “Eurocone” junction fitting
16 x 16 x 16
16 x 16 x 20
20 x 16 x 16
20 x 16 x 20
20 x 16 x 16
20 x 20 x 16



Tigris K1
T connecting pipes

Tigris K1
Angle connecting pipes

Tigris K1
Radiator assembly fittings for the wall

Tigris K1
Radiator assembly fittings for the floor

5.13.3. Manifold assembly

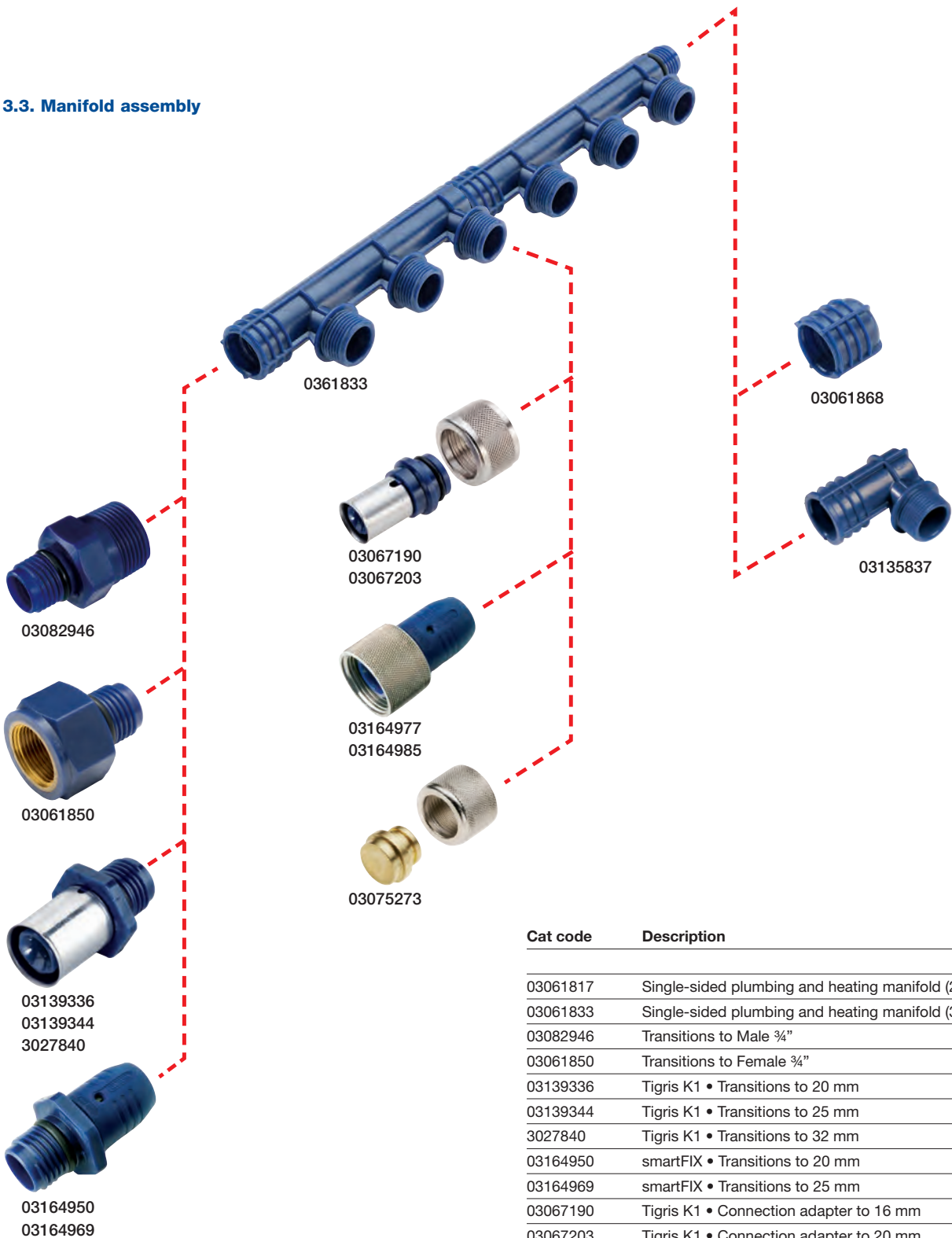

Cat code	Description
03061817	Single-sided plumbing and heating manifold (2-way)
03061833	Single-sided plumbing and heating manifold (3-way)
03082946	Transitions to Male 3/4"
03061850	Transitions to Female 3/4"
03139336	Tigris K1 • Transitions to 20 mm
03139344	Tigris K1 • Transitions to 25 mm
3027840	Tigris K1 • Transitions to 32 mm
03164950	smartFIX • Transitions to 20 mm
03164969	smartFIX • Transitions to 25 mm
03067190	Tigris K1 • Connection adapter to 16 mm
03067203	Tigris K1 • Connection adapter to 20 mm
03164977	smartFIX • Connection adapter to 16 mm
03164985	smartFIX • Connection adapter to 20 mm
03061868	Manifold caps
03075273	Manifold stoppers
03135837	Tigris K1 • 90° manifold connecting elbow

5.14. Cordless and electric press tools

Wavin press-tools are supplied to the highest quality and manufacturing standards. Under correct operation and when all the necessary device inspections are carried out at regular intervals, the press tool warranty runs for 24 months from the despatch date or for 10,000 pressing operations whichever is sooner. Please refer to the respective press tool operating instructions for further details on operation and maintenance. The warranty is activated from the day of despatch from Wavin. The warranty does not cover any damage caused by improper handling or failure to observe the operating instructions or use with pipes or fittings not supplied by Wavin. Warranty services may be provided by the manufacturer only. Claims shall only be accepted if the device is supplied to the manufacturer fully intact, fully documented and with no interventions.

Inspection and service

The reliable performance of the press tool is dependent on careful handling. This is an important requirement for the tool to ensure long-lasting joints. The device requires regular service and maintenance. For the fault message/check list see page 30). Only a clean and operational press tool can ensure a long-lasting sealed joint. The pressing jaws must only be used for their intended purpose of pressing Wavin Tigris fittings and should only be replaced by a qualified technician.



Caution:

Do not open the device! If any seals are damaged the warranty shall be void.

An annual inspection is required. A major service is required every 10,000 pressing operations or every three years, whichever is sooner.

5.14.1. Wavin Tigris K1-/M1 pressing jaw with alternative brand press tools

External certification in accordance with DVGW (German Technical and Scientific Association for Gas and Water) work sheet 534 is carried out exclusively on the basis of press joints created using Wavin pressing jaws and Wavin press tools. If a different press tool is used, it must meet the minimum requirements listed below (e.g. linear thrust of 30 – 34 kN, use a suitable pressing jaw fixture etc) and must be technically flawless. This means it must be serviced and maintained according to the manufacturer's specifications. For the purpose of liability and security, we recommend contacting the respective manufacturer for proof of suitability. In the event that a complaint is made and the damage can be traced back to an unsuitable press tool from a different manufacturer, Wavin shall carry no responsibility or liability.

The press tools must meet the following requirements:

- ⦿ Only Wavin pressing jaws (U-contour) may be used.
- ⦿ The press tool must be operated and serviced according to the respective manufacturer guidelines. The Wavin assembly guidelines must be complied with.
- ⦿ The "mini" press (16 – 32 mm) must provide a linear thrust of at least 15 kN.
- ⦿ The "cordless" press (16 – 63 mm) must provide a linear thrust of 30 kN to 34 kN.
- ⦿ The bolt geometry of the press tool must be suitable for the Wavin pressing jaws.

Important note:

The following press tools from Rems/Roller must not be used with the Wavin pressing jaws:

REMS Power-Press E REMS Power-Press 2000
ROLLER Uni-Press E ROLLER Uni-Press 2000

To check the compatibility of Wavin Tigris K1/M1 pressing jaws with alternative brand press tools, please see overleaf.

The table below illustrates Wavin Tigris K1/M1 pressing jaw compatibility with alternative brand press tools. This table lists only “compatible devices” with a pressing force of 32 kN (± 2 kN) and 40 mm piston stroke. The “mini” versions are not listed here since they are generally not compatible. If using press tools and pressing jaws not listed here, proof of suitability for the Wavin Tigris K1/M1 systems must be provided in accordance with the corresponding national regulations. According to technical specifications, the Wavin Tigris K1/M1 system can be used with the following device types.

Machine type/description	Features	Pressing jaw dimension
Wavin	UAP3L	16 to 63 mm
Wavin	ACO202	16 to 63 mm
Wavin	ECO202	16 to 63 mm
Uponor electric press tool	UP 50 EL	16 to 63 mm
Uponor cordless press tool	UP 75	16 to 63 mm
Uponor electric press tool	UP 75 EL	16 to 63 mm
Geberit “new” PWH-75	Blue sleeve above pressing jaw fixture	16 to 63 mm
Novopress EFP 2 (manuf. after 1996)	Swivel head	16 to 63 mm
Novopress ACO 1/ECO 1 (Pressboy)	ACO 1 = cordless ECO 1 = electric	16 to 63 mm
Novopress ACO201/ECO201	ACO201 = cordless ECO201 = electric	16 to 63 mm
Novopress AFP201/EFP201	AFP201 = cordless EFP201 = electric	16 to 63 mm
Novopress AFP202/EFP202	AFP202 = cordless EFP202 = electric	16 to 63 mm
Klauke ipress	UAP3L	16 to 63 mm
Milwaukee	M18 HPT	16 to 63 mm
REMS Power-Press		16 to 63 mm
REMS Power-Press ACC		16 to 63 mm
REMS Akku-Press		16 to 63 mm
REMS Akku-Press ACC		16 to 63 mm
ROLLER'S Uni-Press		16 to 63 mm
ROLLER'S Uni-Press ACC		16 to 63 mm
ROLLER'S Multi-Press		16 to 63 mm
ROLLER'S Multi-Press ACC		16 to 63 mm
Rothenberger ROMAX® 3000		16 to 63 mm
Ridgid cordless press tool	RP 340-B	16 to 63 mm
Ridgid electric press tool	RP 340-C	16 to 63 mm
Viega cordless press tool	Pressgun 5	16 to 63 mm
Viega cordless press tool	Pressgun 4B	16 to 63 mm
Viega electric press tool	Pressgun 4E	16 to 63 mm
Viega electric	Type PT3-EH/H	16 to 63 mm
Viega electric press tool	Type 2 (manuf. after 1996) Serial numbers starting with 96...; lateral leverage for bolt monitoring	16 to 63 mm

5.14.2 Inspection and service

The following check list can be used when tools require regular inspection and maintenance, or in the event of damage or a complaint.

In the event of local service solutions only the authorised offices and agents of the manufacturers can be considered and then only after prior authorisation from Wavin Overseas

Manufacturer: Novopress tools

ACO 102

ACO 202

ECO 202

and the respective jaws.

Manufacturer: Klauke Tools

UAP2

UAP3L MAP1

MAP2L UP2EL-14

UNP 2

and the respective jaws.

In the first instance all requests for technical support should be sent to your local Wavin Overseas distributor or agent from whom the tool was purchased.

Damage report/check list

Customer: _____

Street: _____

City / Postcode / Country: _____

Telephone / Fax: _____

E-mail: _____

Contact person: _____

Responsible Wavin Overseas distributor or Agent (supplier): _____

Please find enclosed:

- | | | | | |
|-----------------------------------|--------------------------|-----------------|---------------|--------------------------|
| UAP2 cordless press tool | <input type="checkbox"/> | delivered with: | case | <input type="checkbox"/> |
| UAP3L cordless press tool | <input type="checkbox"/> | | battery | <input type="checkbox"/> |
| „Mini“ MAP 1 cordless press tool | <input type="checkbox"/> | | charging unit | <input type="checkbox"/> |
| „Mini“ MAP 2L cordless press tool | <input type="checkbox"/> | | | |
| UP2EL-14 electric press tool | <input type="checkbox"/> | | | |
| UNP 2 electric press tool | <input type="checkbox"/> | | | |
| ACO202 cordless press tool | <input type="checkbox"/> | | | |
| „Mini“ ACO102 cordless press tool | <input type="checkbox"/> | | | |
| ECO202 electric press tool | <input type="checkbox"/> | | | |

Other tools: _____ Pressing jaw _____
 (please indicate number and dimension) _____

Tool number: _____

The tool has been sent for: Repair Service Inspection

- In the event of repair, please specify the reason:
- Tool is losing oil
 - Faulty piston
 - Press procedure not correctly ended
 - Tool does not generate pressure
 - Housing broken
 - Faulty motor
 - Pressing jaw mount cracked
 - Faulty switch
 - Battery does not work
 - Charging unit does not work

Other complaints:

Price quotation requested? Yes No

Date, Location

Signature

5.15. Flushing Wavin Tigris K1/M1 and Wavin smartFIX tap water pipes

The flushing of tap water pipes is described in detail in DIN 1988 part 2.

This treatment of the pipe network ensures the quality of the tap water. All pipe sections must be free of contamination and foreign bodies at the time of initial operation. Time delays between flushing and initial operation of the tap water network must be avoided, as complete drainage is not generally carried out after flushing. According to VDI 6023 – hygiene-conscious planning, execution, operation and maintenance of tap water systems – system sections that are unused for longer than 4 weeks must be flushed again.

5.16. Initial operation and handover

According to DIN 1988-2, the installer of the system must prepare relevant handover and acceptance logs. The system operator must be instructed with respect to the operation of the tap water system created. It is recommended that the instruction being completed is confirmed in writing.

Depending on the scale of the system, the presentation of written operating instructions is advised.

5.17. Checking Wavin Tigris K1 or Tigris M1 (unpressed/unsealed)

This additional test serves as an additional check for unpressed connections. When the function check is carried out with water, the leak from unpressed connections is clearly identifiable.

First a visual check on the connections (pressed/unpressed) should be carried out. A low pressure test with water should then be carried out to further check for any unpressed connections, with conditions as below. The results should be recorded and signed for.

5.17.1 Test Conditions

Test Pressure: Min 0.5 Bar, Max 3 Bar

Test duration: 15 minutes after temperature equalisation between the pipe and the test medium.

Note: In case of greater temperature differences (~10 K) between the ambient temperature and the filling water temperature, a waiting time of 30 minutes has been observed for temperature equalisation after filling of the system.

Test differential pressure: 0.0 bar.

There should be no pressure drop during this test. A further visual check should be carried out to ensure there are no leaking connections.

5.18. Main System Pressure Test (all fittings systems)

It is essential that a system pressure test is carried out in line with the relevant local regulations for plastic pipe systems used for drinking water or heating systems. Clean filtered drinking water should be used for the test.

If there are no clear local regulations available then Wavin recommends to use the testing procedures according to DIN 1998 Part 2. The main requirements of the test conditions, including records to be kept are summarised below.

5.18.1. Pressure Test to DIN 1988 Part 2 (if no local test regulation available)

Test pressure = authorised max. operating pressure x 1.1; min. 11 bar (based on the lowest point of the system)

All pipelines must undergo a pressure test. The pipes completed but not yet tested must be filled with filtered tap water (protect from frost). Connect the pressure gauge to the lowest point on the installation to be tested. Use only pressure gauges that allow reliable reading of a pressure change of 0.1 bar.

Valves or other blocking agents before and after heat producers and boilers must be closed in order to keep the test pressure away from the rest of the system. The pipeline must then be checked with test pressure and reduced to operating pressure. The test pressure is the authorised positive operating pressure for the system x 1.1. For tap water systems with an authorised positive operating pressure of e.g. 10 bar, the test pressure is 11 bar. The maximum positive operating pressure for pressure booster systems must be checked.

$\Delta \leq 10$ K Ambient temperature to fill temperature temperature difference must be max $\pm 10^\circ$ C

Test pressure: maximum positive operating pressure x 1.1 (min. 11 bar)

Test duration: 30 minutes after temperature equalisation between the pipe and the test medium.

Test differential pressure: 0.0.

Main test

Start: _____ Time Test pressure: _____ bar
Date

End: _____ Time Test pressure: _____ bar
Date (max. pressure drop 0.0)

Finally, all pipe connections must undergo a visual inspection.

No leaks were found in the aforementioned system during the main test.

Certification

Place, date Contractor signature/stamp

Place, date Client signature/stamp

5.19. Flushing heating installations

The completed heating installation must be flushed thoroughly before initial operation. This process removes metallic residues and contaminants that may have entered the pipe system during the construction activity.

Metallic contaminants in particular may result in long-term damage through corrosion on heating surfaces such as plate radiators or the heat generator.

5.20. Pressure test in accordance with DIN 18380

5.20.1. Pressure testing heating installations

Heating pipe installations must undergo a thorough visual inspection after completion, before openings are sealed and before the screed work, as unpressed or incorrectly pressed connections must be inspectable during and immediately after the leak test and pressure test.

All pipelines installed must always undergo a pressure test in accordance with DIN 18380 or equivalent local regulations. To do this, the pipes completed but not yet covered must be filled with water (caution: risk of frost; use glycol additive if necessary – see also page 31).

The proper execution of the pressure test in accordance with DIN 18380 is described in the corresponding pressure test log from this handbook. To ensure the guarantee, the pressure test for heating installations is to be conducted only in accordance with the specifications of this form.

5.20.2. Test (unpressed/unsealed)

See Section 5.17 above.



CONNECT TO BETTER

Discover our broad portfolio at
www.wavinoverseas.com
www.wavin.ae
www.wavin.asia



Water management | Heating and cooling | Water and gas distribution
Waste water drainage | Cable ducting

Connect to better at:

- ⦿ www.wavinoverseas.com or
- ⦿ www.wavin.ae for Middle East & North Africa
- ⦿ www.wavin.asia for Asia Pacific

Wavin operates a programme of continuous product development, and therefore reserves the right to modify or amend the specification of their products without notice. All information in this publication is given in good faith, and believed to be correct at the time of going to press. However, no responsibility can be accepted for any errors, omissions or incorrect assumptions. Users should satisfy themselves that products are suitable for the purpose and application intended.



CONNECT TO BETTER