

Wavin

Listino 2023

# Listino generale

- Sistemi di adduzione Tigris e Smartfix, scarico e raccordi a pressione
- Sanitherm NG
- Hep<sub>2</sub>O
- Indoor Climate Solutions

Consulta qui i listini  
Wavin aggiornati



**wavin**

orbia 



# Indice

<b>SISTEMI DI ADDUZIONE TIGRIS E SMARTFIX, SCARICO E RACCORDI A PRESSIONE</b>	<b>5</b>
<b>LA FAMIGLIA TIGRIS</b>	<b>5</b>
<b>TIGRIS MP</b>	
Tubo multistrato per adduzione idrica	17
<b>TIGRIS M5 - M1</b>	
Raccordi a pressare in ottone per tubo multistrato	21
<b>TIGRIS K5-K1</b>	
Raccordi a pressare in materiale sintetico per tubo multistrato	45
<b>SMARTFIX</b>	
Raccordi ad innesto rapido per tubo multistrato	63
<b>ATTREZZATURE MP</b>	
Attrezzature per i sistemi multistrato	69
<b>TIGRIS GREEN</b>	
Sistema di adduzione idrica in PP-Random	75
<b>WAVIN PE</b>	
Sistema di scarico in polietilene	101
<b>ED TECH</b>	
Sistema di scarico in polipropilene	127
<b>SITECH+</b>	
Sistema di scarico rinforzato e insonorizzato in PP	145
<b>WAVIN AS+</b>	
Sistema di scarico insonorizzato	161
<b>ACCESSORI PER SCARICO</b>	
Accessori per Wavin PE, Wavin EdTech, Wavin SiTech, Wavin AS, Wavin AS+	177
<b>WAVIN EMÙ</b>	
Sifoni - Pozzetti - Colonne vasca	189
<b>WAVIN ÉLITE</b>	
Ricambi per cassette di sciacquo	255
<b>WAVIN PE100</b>	
Sistemi di raccordi in polietilene per condotte in pressione	259
<b>PRESS-RING</b>	
Raccordi a compressione	283

**SANITHERM NG****293**

Tubi	294
Raccordi a pressare	296
Attrezzature	307

**SISTEMA Hep<sub>2</sub>O****313**

Sistema Slider	332
Sistema Heptherm	326

**INDOOR CLIMATE SOLUTIONS****331****CLIMATIZZAZIONE RADIANTE****332**

Sistemi radianti a soffitto e parete	333
Sistemi radianti a pavimento	338
Collettori	350
Termoregolazioni	362
Attrezzature per sistemi radianti	370

**VENTILAZIONE MECCANICA CONTROLLATA****375**

Unità di deumidificazione e trattamento dell'aria DEUKLIMA	376
Unità di ventilazione decentralizzate VENTIZA SOLO	378
Unità di ventilazione residenziali VENTIZA HP	380
Unità di ventilazione residenziali VENTIZA DUO	381
Unità di ventilazione residenziali a basamento VENTIZA FLOOR	382
Unità di ventilazione residenziali ad incasso VENTIZA IN	386
Unità di ventilazione residenziali a soffitto a basso spessore	387
Unità di ventilazione non residenziali efficienza 90%	388
Unità di ventilazione non residenziali efficienza 80%	390
Unità di ventilazione per scuole VENTIZA EDU	392
Unità di ventilazione e deumidificazione VENTIZA COMBI	394
Accessori per unità di ventilazione	397
Sistema di distribuzione aria con tubi circolari in lamiera zincata	399
Sistema di distribuzione aria a plenum	404
Terminali di aspirazione e immissione	411

<b>CONTROLLI</b>	421
Sistema Sentio	422
Sistema Reklima Bus RKB	426
Regolatori ambiente mono zona	427
<b>PRIMA ACCENSIONE</b>	428
<b>CONDIZIONI GENERALI DI VENDITA</b>	429

I prezzi e i prodotti contenuti in questo listino potrebbero subire delle variazioni durante l'anno. Puoi trovare la versione aggiornata nell'area download del nostro sito. Accedi inquadrando il QR CODE in copertina oppure digitando [www.wavin.it/listini](http://www.wavin.it/listini)



# La famiglia Tigris



### Un'unica tubazione per diverse tipologie di raccordi

Con il sistema Tigris, Wavin propone una gamma completa di raccordi e tubazioni per applicazioni multistrato. 5 famiglie di raccordi con lo scopo di offrire connessioni affidabili per un'unica tubazione multistrato.

La tecnologia si basa sull'affidabile pressatura Radiale, offrendo sia una soluzione in PPSU (Tigris K5 e K1) che in ottone (Tigris M5 e M1). La Famiglia si completa con la soluzione smartFIX, tecnologia push fit in PPSU.

I sistemi sono ideali per gli impianti di distribuzione dell'acqua potabile, per gli impianti di riscaldamento e impianti ad acqua refrigerata. Sono fisiologicamente idonei al convogliamento di acque potabili e di fluidi alimentari, garantendo inalterabilità e qualità del fluido trasportato, in conformità al D.M. 174.

### Tigris MP - caratteristiche

Il tubo multistrato Wavin per gli impianti sanitari e di riscaldamento è composto da uno strato interno in polietilene reticolato (PE-Xc), uno strato esterno in PE e da uno strato intermedio in alluminio saldato longitudinalmente di testa. I tre strati sono legati uno all'altro mediante adesivo. Il tubo è quindi composto da cinque strati.

#### Vantaggi principali

- Elevata flessibilità, abbinata alla stabilità dimensionale, e ideale in caso di posa in spazi molto stretti
- Minima dilatazione lineare, comparabile al rame, grazie allo strato di alluminio
- Montaggio rapido e sicuro
- Idoneo per il trasporto di acque, di cui garantisce inalterabilità e qualità
- Fisiologicamente idoneo al convogliamento dei fluidi alimentari
- Immune alle incrostazioni

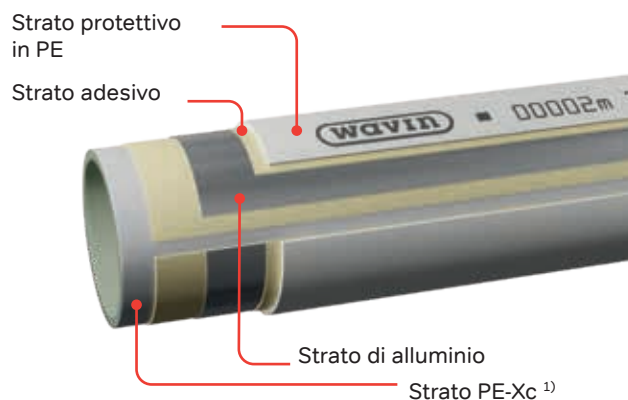

Struttura del tubo multistrato Wavin

### Caratteristiche tubazione Wavin Tigris MP

- Sezione di passaggio più ampia per prestazioni di portata ottimali
- Ampio range di applicazioni, sia per acqua potabile che riscaldamento
- Adatto a tutti i tipi di qualità dell'acqua
- Alta resistenza chimica ed alle pressioni elevate
- Strato di alluminio saldato di testa; spessore uniforme e resistenza al distacco
- Fisiologicamente innocuo
- Peso ridotto
- Montaggio rapido e sicuro
- Disponibilità di tubazioni in barre, rotoli e rotoli preisolati
- Facilità al taglio ed alla curvatura
- Dimensioni da 16 mm a 75 mm

L'eccellente sagomabilità del tubo Wavin Tigris MP è data dallo spessore ottimale dell'alluminio che rende il tubo estremamente flessibile tanto da poter essere piegato a mano

La curvatura può essere realizzata con curvatubi o mole piegatubi. La tubazione, dopo essere stata sagomata in base alle proprie esigenze impiantistiche, rimane stabile.



Il PE-Xc identifica il processo di reticolazione di tipo fisico del PE (bombardamento di elettroni). Grazie alla reticolazione, il PE presenta un'elevata stabilità termica che lo predispone soprattutto per il trasporto dell'acqua potabile e per connessioni al radiatore ad alta temperatura. La reticolazione di tipo fisico garantisce un'ottima qualità dell'acqua potabile senza aggiunta di sostanze chimiche.

Il PE-Xc viene in genere scelto quando vengono applicate condizioni più estreme, come la disinfezione chimica o termica.

#### Applicazioni per acqua potabile

I sistemi sono fisiologicamente idonei al convogliamento di acque potabili e di fluidi alimentari, garantendo inalterabilità e qualità del fluido trasportato, in conformità al D.M. 174.



Tigris MP per applicazioni multiple

La tubazione Tigris MP adempie i requisiti della ISO 21003 per applicazioni di trasporto dell'acqua potabile.

Riferirsi al capitolo "Specifiche Tecniche Tubazione MP" per maggiori dettagli.

### I Sistemi radiali

Il principio si basa sulla deformazione della boccola presente sul raccordo tramite una pressatrice in grado di creare allo stesso tempo la tenuta ed il collegamento meccanico in una sola pressata. Dal momento che la boccola viene deformata in una direzione radiale rispetto al tubo, viene chiamato sistema Radiale.

Il sistema Radiale offre molti vantaggi rispetto ai metodi di connessione alternativi.

È un modo molto veloce per creare una connessione duratura e affidabile; basta tagliare la tubazione, infilarla nel raccordo e pressare.

I raccordi Wavin Tigris sono stati testati anche oltre gli elevati standard qualitativi, con lo scopo di simulare una durata del sistema di 50 anni.

I raccordi a pressione Tigris sono sottoposti a costanti controlli interni di qualità e monitoraggio esterno continuo. Sono certificati DVGW e testati secondo EN-ISO 21003.



Sistema Radiale Tigris

Il sistema Radiale può coprire una vasta gamma di diametri, rendendo il sistema Tigris adatto ad ogni tipo di applicazione.

**Velocità, affidabilità, varietà per il sistema radiale Wavin Tigris**

**Il Sistema ad innesto**

Il sistema ad innesto Wavin smartFIX offre rapidità di esecuzione senza l'impiego di pressatrici. I principali vantaggi delle soluzioni Push-Fit sono la velocità di installazione e il risparmio di tempo. Un raccordo Push-Fit può essere montato in pochi secondi.

Basta spingere il tubo nel raccordo e l'installazione è fatta. Gli strumenti sono necessari solo per tagliare e calibrare la tubazione.

I raccordi Wavin smartFIX sono particolarmente indicati per connessioni in spazi difficilmente accessibili alle attrezzature standard, garantendo comunque una giunzione veloce ed affidabile.



Sistema push-fit Tigris smartFIX

La Famiglia Tigris



# Una tubazione adatta a tutti

Serie PPSU		Serie ottone		
Innesto	Radiale		Radiale	
				
<b>Tigris smartFIX</b> 16-25 mm	<b>Tigris K5</b> 16-40 mm	<b>Tigris K1</b> 50-75 mm	<b>Tigris M5</b> 16-40 mm	<b>Tigris M1</b> 50-75 mm

Tabella comparativa

Lo schema in basso fornisce una panoramica delle diverse caratteristiche, quali composizione, dimensioni e profili di pressatura. Alla pagina seguente potrete trovare la spiegazione delle icone relative.

Caratteristiche prodotto

					
	Tigris M5	Tigris K5	Tigris M1	Tigris K1	smartFIX
 <b>MULTI JAW</b>	✓	✓			
 <b>OPTI FLOW</b>	✓	✓			
 <b>EASY FIT</b>	✓	✓			
 <b>ACOUSTIC LEAK ALERT</b> <b>NEW</b>	✓	✓			
 <b>DEFINED LEAK</b>	✓	✓	✓	✓	
 <b>IN 4SURE</b>	✓	✓	✓	✓	✓
 <b>PIPE GRIP</b>	✓	✓	✓	✓	✓
 <b>ULTRA SEAL</b>	✓	✓	✓	✓	✓
<b>Diametri</b>	16-40	16-40	50-75	50-75	16-25
<b>Materiale</b>	Ottone	PPSU	Ottone	PPSU	PPSU
<b>Profili di pressatura</b>	U, Up, TH, H, B	U, Up, TH, H, B	U	U	Push-Fit
<b>Dimensioni speciali</b>	20 x 2.0 26 x 3.0	-	-	-	-

Panoramica caratteristiche

Caratteristiche del Sistema Tigris



**MULTI JAW**

**Compatibilità con diversi profili: U, Up, TH, B, H**

Progettati per essere utilizzati con la maggior parte dei profili presenti sul mercato: U,Up,H,TH e B. Nessuna necessità di acquistare nuove attrezzature, rendendo più semplice il cambio al nuovo sistema Tigris Serie 5. La garanzia Wavin copre l'utilizzo di tali profili.



**OPTI FLOW**

**Sezione di passaggio aumentata per prestazioni di portata ottimali**

Una sezione aumentata porta ad un'ottimizzazione della portata, riducendo di conseguenza le perdite di carico.



**EASY FIT**

**Inserimento facilitato senza svasatura**

Dopo aver tagliato la tubazione (diritta), questa può essere innestata al raccordo senza prima procedere con la calibratura. Grazie al profilo esagonale, il design particolare della boccola e la posizione degli O-ring, la tubazione può essere inserita con una bassa forza d'innesto e nessun rischio di danneggiamento degli O-rings.



**ACOUSTIC LEAK ALERT**

**NEW**

**Raccordi non pressati evidenziati da un fischio**

Quando la tubazione è inserita all'interno del raccordo, ma l'installatore si dimentica di pressarlo, la connessione perde. Quando si effettua il test di pressione ad aria, il raccordo può essere facilmente rintracciato grazie al fischio emesso.



**DEFINED LEAK**

**Perdita visivamente rilevata nel caso di mancata pressatura**

Quando la tubazione è inserita all'interno del raccordo, ma l'installatore si dimentica di pressarlo, la connessione perde. Quando si effettua il test di pressione ad acqua, il raccordo può essere facilmente rintracciato grazie al getto d'acqua.



**IN4SURE™**

**Inserimento corretto visibile a 360°**

È importante inserire la tubazione bene a fondo per garantirne la tenuta con il raccordo. Un controllo visivo ne prova il corretto inserimento.



**PIPE GRIP**

**La tubazione sta in posizione prima della pressatura**

Quando la tubazione è correttamente inserita all'interno del raccordo, può mantenere la posizione finché la boccola non sarà pressata. La caratteristica PipeGrip previene movimenti indesiderati per garantire una pressatura affidabile.



**ULTRA SEAL**

**Tenuta degli O-ring affidabile, oltre gli standard qualitativi**

L'affidabile tenuta degli O-rings è garantita da test in condizioni estreme, effettuati a 110°C, ben oltre il massimo valore di 95°C richiesto dalla normativa.

Spiegazione caratteristiche

# Dati Tecnici

## Specifiche Tecniche

### Specifiche Tecniche Tubazione Tigris MP

<b>Applicazioni</b>	Impianti di distribuzione dell'acqua potabile, impianti di riscaldamento e impianti ad acqua refrigerata
<b>Colore</b>	bianco



<b>Materiale</b>	<b>PE-Xc</b> Strato interno in polietilene con reticolazione elettrofisica (PE-Xc), strato esterno in PE, strato intermedio in alluminio; i tre strati sono collegati tra loro mediante un adesivo speciale
------------------	--

<b>Comportamento al fuoco</b>	DIN EN 13501: E DIN 4102: B2
-------------------------------	---------------------------------

Parametri di esercizio	Classe	Temperatura di esercizio	Pressione di esercizio
	1	60°C	10 bar
	2	70°C	10 bar
	4	20-40-60°C	10 bar
	5	20-40-80°C	6 bar

<b>Coefficiente di dilatazione termica</b>	0,025 – 0,030 mm/m·K
--	----------------------



<b>Conducibilità termica</b>	0,4 W/ m·K
------------------------------	------------

<b>Rugosità</b>	0,007mm
-----------------	---------

Specifiche Tecniche Tigris MP.



**Specifiche Tecniche Raccordi**

**Specifiche Tecniche Tigris K5 e Tigris M5**

	<b>Tigris K5 (16-40 mm)</b>	<b>Tigris M5 (16-40 mm)</b>
Materiale	Polifenilsulfone (corpo in PPSU) bussole preassemblate in acciaio elementi filettati: Ecobrass (CW724R)	Corpo in ottone (CW 617N/ CW625N/ CW 724R), bussole preassemblate in acciaio inossidabile
Colore	Raccordo blue e fixing trasparente 	Raccordo ottone e fixing trasparente 
Temperatura massima	85°C a 6 bar, 70°C a 10 bar	
Temperatura di esercizio in continuo		
Temperatura di malfunzionamento	100°C (massimo 100 ore in 50 anni)	
Pressione massima di esercizio in continuo	10 bar a 70°C	

Specifiche tecniche Tigris K5 e Tigris M5

**Specifiche Tecniche Tigris K1 e Tigris M1**

	<b>Tigris K1 (50-75)</b>	<b>Tigris M1 (50-75)</b>
Materiale	Polifenilsulfone (PPSU) bussole preassemblate in acciaio inossidabile elementi filettati: Ecobrass (CW724R)	Ottone stagnato (CW617N), bussole preassemblate in acciaio inossidabile
Colore	Blue 	Corpo del raccordo Silver con fixing blu 
Temperatura massima	85°C a 6 bar, 70°C a 10 bar	
Temperatura di esercizio in continuo		
Temperatura di malfunzionamento	100°C (massimo 100 ore in 50 anni)	
Pressione massima di esercizio in continuo	10 bar a 70°C	

Specifiche Tecniche Tigris K1 e Tigris M1.



**Specifiche tecniche smartFIX****smartFIX**

Materiale	Polifenilsulfone (PPSU), per il corpo del raccordo e l'anello di fissaggio. Calotte in poliammide rinforzato con fibre di vetro. Elementi filettati: Ecobrass (CW724R)
Colore	Blue 
Temperatura massima	85°C a 6 bar, 70°C a 10 bar
Temperatura di esercizio in continuo	
Temperatura di malfunzionamento	100°C (massimo 100 ore in 50 anni)
Pressione massima di esercizio in continuo	10 bar a 70°C

Specifiche Tecniche Tigris smartFIX.



# Wavin Tigris MP



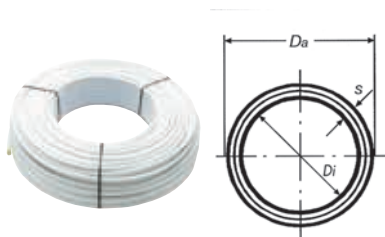

**Tubi in rotoli**

Codice	Classe	Ø	Da mm	Di mm	s mm	Lungh. mt.	Pallet mt.	Conf. mt.	Euro mt
<b>340072</b>	F1	16 x 2	16	12	2,0	100	1000	100	<b>6,94</b>
<b>R 340082</b>	F1	16 x 2	16	12	2,0	200	1400	200	<b>6,94</b>
<b>340077</b>	F1	20 x 2	20	16	2,0	100	700	100	<b>8,59</b>
<b>340074</b>	F1	20 x 2,25	20	15,5	2,25	100	700	100	<b>9,06</b>
<b>340075</b>	F1	25 x 2,5	25	20	2,5	50	350	50	<b>13,53</b>
<b>340078</b>	F1	26 x 3	26	20	3	50	200	50	<b>14,55</b>
<b>340076</b>	F1	32 x 3	32	26	3,0	50	200	50	<b>20,04</b>

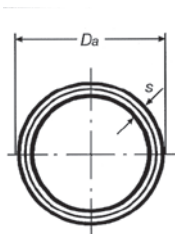

**Tubi in barre**

Codice	Classe	Ø	Da mm	Di mm	s mm	Lungh. mt.	Conf. mt.	Euro mt
<b>340062</b>	F1	16 x 2	16	12	2,0	5	125	<b>9,92</b>
<b>340060</b>	F1	20 x 2	20	16	2,0	5	90	<b>12,34</b>
<b>340064</b>	F1	20 x 2,25	20	15,5	2,25	5	90	<b>12,97</b>
<b>340065</b>	F1	25 x 2,5	25	20	2,5	5	50	<b>15,46</b>
<b>340061</b>	F1	26 x 3	26	20	3,0	5	50	<b>16,44</b>
<b>340066</b>	F1	32 x 3	32	26	3	5	30	<b>21,83</b>
<b>340067</b>	F1	40 x 4	40	32	4	5	20	<b>36,99</b>
<b>340068</b>	F1	50 x 4,5	50	41	4,5	5	10	<b>65,12</b>
<b>340069</b>	F1	63 x 6	63	51	6	5	15	<b>113,11</b>
<b>340070</b>	F1	75 x 7,5	75	60	7,5	5	5	<b>182,48</b>

**R** Contattare il Customer Service per tempistiche sulla disponibilità



### Tubi preisolati in rotoli

Codice	Classe	Ø	Da mm	s mm	Lungh. mt.	Spess. isol. mm	Pallet mt.	Conf. mt.	Euro mt.
<b>340032B</b>	F1	16 x 2	16	2,0	50	6	700	50	<b>9,05</b>
<b>340037B</b>	F1	20 x 2	20	2,0	50	6	500	50	<b>11,20</b>
<b>340038B</b>	F1	20 x 2	20	2,0	50	9	500	50	<b>11,85</b>
<b>340034B</b>	F1	20 x 2,25	20	2,25	50	9	500	50	<b>12,42</b>
<b>340035B</b>	F1	25 x 2,5	25	2,5	25	9	275	25	<b>19,21</b>
<b>340135B</b>	F1	25 x 2,5	25	2,5	50	9	450	50	<b>19,21</b>
<b>340039B</b>	F1	26 x 3	26	3,0	50	9	450	50	<b>20,99</b>
<b>340036B</b>	F1	32 x 3	32	3,0	25	9	125	25	<b>26,90</b>



### Tubi preisolati in rotoli per condizionamento

Codice	Classe	Ø	Da mm	s mm	Lungh. mt.	Spess. mt.	Pallet mt.	Conf. mt.	Euro mt.
<b>340042</b>	F1	16 x 2	16	2,0	50	9	250	50	<b>15,39</b>
<b>340047</b>	F1	20 x 2	20	2,0	50	13	200	50	<b>19,30</b>
<b>340044</b>	F1	20 x 2,25	20	2,25	50	13	200	50	<b>20,24</b>
<b>340045</b>	F1	25 x 2,5	25	2,5	25	13	125	25	<b>30,70</b>
<b>340048</b>	F1	26 x 3	26	3,0	25	13	125	25	<b>33,61</b>
<b>340046</b>	F1	32 x 3	32	3,0	25	13	100	25	<b>40,72</b>



# Wavin Tigris M5 -M1





**Manicotti Tigris M5**

Codice	Classe	Do1 x Spess.	Do2 x Spess.	L mm	Z mm	Z1 mm	Z2 mm	Z3 mm	P0	P1	Scat.	Conf.	Euro pz.
<b>4063971</b>	F2	16x2	16x2	68			17				80	10	<b>18,65</b>
<b>4063973</b>	F2	20x2	20x2	68			17				80	10	<b>23,86</b>
<b>4063972</b>	F2	20x2,25	20x2,25	68			17				80	10	<b>23,86</b>
<b>4063974</b>	F2	25x2,5	25x2,5	78			17				40	5	<b>38,10</b>
<b>4063975</b>	F2	26x3	26x3	78			17				40	5	<b>40,21</b>
<b>4064166</b>	F2	32x3	32x3	78			17				40	5	<b>67,66</b>
<b>4064167</b>	F2	40x4	40x4	100			17				15	5	<b>120,98</b>

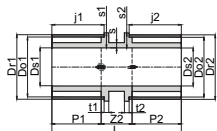

**Manicotti Tigris M1**

Codice	Classe	Do1 x Spess.	Do2 x Spess.	L mm	Z mm	Z1 mm	Z2 mm	Z3 mm	P0	P1	Scat.	Conf.	Euro pz.
<b>345008</b>	F2	50x4,5	50x4,5	100			24				4	1	<b>173,28</b>
<b>345009</b>	F2	63x6	63x6	148			28				4	1	<b>313,92</b>
<b>345010</b>	F2	75x7,5	75x7,5	152			30				4	2	<b>404,73</b>



**Manicotti ridotti Tigris M5**

Codice	Classe	Do1 x Spess.	Do2 x Spess.	L mm	Z mm	Z1 mm	Z2 mm	Z3 mm	P0	P1	Scat.	Conf.	Euro pz.
<b>4064183</b>	F2	20x2	16x2	70			19				80	10	<b>24,90</b>
<b>4064182</b>	F2	20x2,25	16x2	70			19				80	10	<b>24,90</b>
<b>4064185</b>	F2	25x2,5	20x2,25	75			19				40	5	<b>39,50</b>
<b>4064186</b>	F2	26x3	20x2	75			19				40	5	<b>40,35</b>
<b>4064187</b>	F2	26x3	25x2,5	78			17				40	5	<b>44,16</b>
<b>4064190</b>	F2	32x3	25x2,5	80			19				40	5	<b>58,68</b>
<b>4064191</b>	F2	32x3	26x3	80			19				40	5	<b>60,25</b>
<b>4064192</b>	F2	40x4	25x2,5	91			19				20	5	<b>120,01</b>
<b>4064193</b>	F2	40x4	32x3	91			19				20	5	<b>122,12</b>

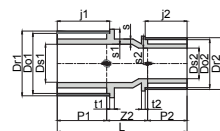

**Manicotti ridotti Tigris M1**

Codice	Classe	Do1 x Spess.	Do2 x Spess.	L mm	Z mm	Z1 mm	Z2 mm	Z3 mm	P0	P1	Scat.	Conf.	Euro pz.
<b>345087</b>	F2	50x4,5	40x4	98			22				18	3	<b>154,65</b>
* <b>345097</b>	F2	63x6	40x4	122			24				8	2	<b>322,77</b>
<b>345098</b>	F2	63x6	50x4,5	123			25				8	2	<b>289,73</b>
<b>345109</b>	F2	75x7,5	63x6	144			23				4	2	<b>380,41</b>



\* Ad esaurimento





**Manicotti filettati maschio Tigris M5**

Codice	Classe	Do1 x Spess.	Do2	L mm	Z mm	Z1 mm	Z2 mm	Z3 mm	P0	P1	Scat.	Conf.	Euro pz.
<b>4064263</b>	F2	16x2	1/2"	57			32				80	10	<b>13,33</b>
<b>4064268</b>	F2	20x2	1/2"	57			32				80	10	<b>18,65</b>
<b>4064269</b>	F2	20x2	3/4"	59			34				80	10	<b>21,18</b>
<b>4064265</b>	F2	20x2,25	1/2"	57			32				80	10	<b>18,65</b>
<b>4064266</b>	F2	20x2,25	3/4"	59			34				80	10	<b>21,18</b>
<b>4064270</b>	F2	25x2,5	3/4"	64			33				40	5	<b>25,68</b>
<b>4064271</b>	F2	25x2,5	1"	68			37				40	5	<b>39,77</b>
<b>4064272</b>	F2	26x3	3/4"	64			33				40	5	<b>29,53</b>
<b>4064273</b>	F2	32x3	1"	68			37				40	5	<b>45,92</b>
<b>4064276</b>	F2	40x4	1"1/4	81			40				20	5	<b>95,10</b>

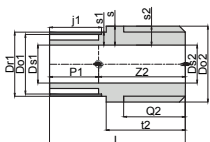

**Manicotti filettati maschio Tigris M1**

Codice	Classe	Do1 x Spess.	Do2	L mm	Z mm	Z1 mm	Z2 mm	Z3 mm	P0	P1	Scat.	Conf.	Euro pz.
<b>345860</b>	F2	50x4,5	1"1/2	61			23				16	4	<b>137,86</b>
<b>345980</b>	F2	63x6	2"	85			25				8	2	<b>267,13</b>
<b>345190</b>	F2	75x7,5	2"1/2	95			34				4	2	<b>356,09</b>

**Manicotti filettati femmina Tigris M5**

Codice	Classe	Do1 x Spess.	Do2	L mm	Z mm	Z1 mm	Z2 mm	Z3 mm	P0	P1	Scat.	Conf.	Euro pz.
<b>4064245</b>	F2	16x2	1/2"	53			15				80	10	<b>17,33</b>
<b>4064250</b>	F2	20x2	1/2"	54			15				80	10	<b>23,66</b>
<b>4064251</b>	F2	20x2	3/4"	55			15				80	10	<b>27,01</b>
<b>4064247</b>	F2	20x2,25	1/2"	54			15				80	10	<b>23,66</b>
<b>4064248</b>	F2	20x2,25	3/4"	55			15				80	10	<b>27,01</b>
<b>4064252</b>	F2	25x2,5	3/4"	60			15				40	5	<b>30,07</b>
<b>4064254</b>	F2	26x3	3/4"	60			15				40	5	<b>34,50</b>
<b>4064255</b>	F2	26x3	1"	63			16				40	5	<b>42,70</b>
<b>4064256</b>	F2	32x3	1"	63			16				40	5	<b>56,12</b>
<b>4064259</b>	F2	40x4	1"1/4	77			16				20	5	<b>132,31</b>

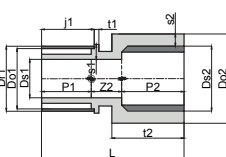

**Manicotti filettati femmina Tigris M1**

Codice	Classe	Do1 x Spess.	Do2	L mm	Z mm	Z1 mm	Z2 mm	Z3 mm	P0	P1	Scat.	Conf.	Euro pz.
<b>345608</b>	F2	50x4,5	1"1/2	78			25				12	3	<b>135,88</b>
<b>345809</b>	F2	63x6	2"	103			17				8	2	<b>274,80</b>



**Gomito 45° Tigris M5**

Codice	Classe	Do1 x Spess.	Do2 x Spess.	L mm	Z mm	Z1 mm	Z2 mm	Z3 mm	P0	P1=P2	Scat.	Conf.	Euro pz.
<b>4064208</b>	F2	40x4	40x4			17	17			41	15	5	<b>135,48</b>



**Gomiti 45° Tigris M1**

Codice	Classe	Do1 x Spess.	Do2 x Spess.	L mm	Z mm	Z1 mm	Z2 mm	Z3 mm	P0	P1=P2	Scat.	Conf.	Euro pz.
<b>341508</b>	F2	50x4,5	50x4,5			22	22			38	6	3	<b>199,98</b>
<b>341509</b>	F2	63x6	63x6			27	27			60	4	2	<b>450,20</b>
* R <b>341510</b>	F2	75x7,5	75x7,5			26	26				2	1	<b>550,39</b>

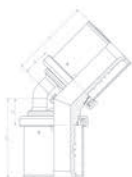

**Gomiti 90° Tigris M5**

Codice	Classe	Do1 x Spess.	Do2 x Spess.	L mm	Z mm	Z1 mm	Z2 mm	Z3 mm	P0	P1	Scat.	Conf.	Euro pz.
<b>4064199</b>	F2	16x2	16x2			18	18				80	10	<b>23,86</b>
<b>4064201</b>	F2	20x2	20x2			20	20				80	10	<b>39,68</b>
<b>4064200</b>	F2	20x2,25	20x2,25			20	20				80	10	<b>39,68</b>
<b>4064202</b>	F2	25x2,5	25x2,5			22	22				40	5	<b>47,43</b>
<b>4064203</b>	F2	26x3	26x3			22	22				40	5	<b>49,43</b>
<b>4064204</b>	F2	32x3	32x3			26	26				20	5	<b>72,24</b>
<b>4064205</b>	F2	40x4	40x4			29	29				15	5	<b>135,88</b>

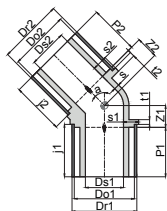

**Gomiti 90° Tigris M1**

Codice	Classe	Do1 x Spess.	Do2 x Spess.	L mm	Z mm	Z1 mm	Z2 mm	Z3 mm	P0	P1	Scat.	Conf.	Euro pz.
* <b>341007</b>	F2	40x4	40x4			34	34			38	15	5	<b>135,88</b>
<b>341008</b>	F2	50x4,5	50x4,5			39	39			38	8	2	<b>192,18</b>
<b>341009</b>	F2	63x6	63x6			48	48			60	4	2	<b>451,65</b>
<b>341010</b>	F2	75x7,5	75x7,5			51	51				2	1	<b>647,41</b>

**Gomiti filettati maschio Tigris M5**

Codice	Classe	Do1 x Spess.	Do2	L mm	Z mm	Z1 mm	Z2 mm	Z3 mm	P0	P1	Scat.	Conf.	Euro pz.
<b>4064210</b>	F2	16x2	1/2"			21	31				80	10	<b>20,84</b>
<b>4064214</b>	F2	20x2	1/2"			21	33				80	10	<b>31,86</b>
<b>4064215</b>	F2	20x2	3/4"			24	35				80	10	<b>33,79</b>
<b>4064212</b>	F2	20x2,25	1/2"			21	33				80	10	<b>31,86</b>
<b>4064213</b>	F2	20x2,25	3/4"			24	35				80	10	<b>33,79</b>
<b>4064216</b>	F2	25x2,5	3/4"			24	38				40	5	<b>38,89</b>
<b>4064218</b>	F2	26x3	3/4"			24	38				40	5	<b>43,14</b>
<b>4064219</b>	F2	32x3	1"			27	45				20	5	<b>80,59</b>
<b>4064220</b>	F2	40x4	1"1/4			50	34				10	5	<b>170,90</b>

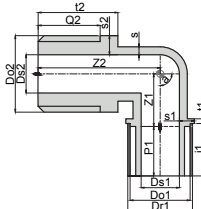

R Contattare il Customer Service per tempistiche sulla disponibilità - \* Ad esaurimento



**Gomiti filettati maschio Tigris M1**

Codice	Classe	Do1 x Spess.	Do2	L mm	Z mm	Z1 mm	Z2 mm	Z3 mm	P0	P1	Scat.	Conf.	Euro pz.
<b>341860</b>	F2	50x4,5	1"1/2			42	56				6	3	<b>248,23</b>
<b>341980</b>	F2	63x6	2"			48	70				4	2	<b>583,17</b>
* R <b>341190</b>	F2	75x7,5	2"1/2			52	84				2	2	<b>736,36</b>



**Gomiti filettati femmina Tigris M5**

Codice	Classe	Do1 x Spess.	Do2	L mm	Z mm	Z1 mm	Z2 mm	Z3 mm	P0	P1	Scat.	Conf.	Euro pz.
<b>4064222</b>	F2	16x2	1/2"			22	13		13	25	80	10	<b>20,84</b>
<b>4064226</b>	F2	20x2	1/2"			22	15		13	26	50	10	<b>31,06</b>
<b>4064227</b>	F2	20x2	3/4"			26	15		15	26	40	10	<b>32,01</b>
<b>4064224</b>	F2	20x2,25	1/2"			22	15		13	26	50	10	<b>31,06</b>
<b>4064225</b>	F2	20x2,25	3/4"			26	15		15	26	40	10	<b>32,01</b>
<b>4064228</b>	F2	25x2,5	3/4"			26	16		15	30	30	5	<b>54,72</b>
<b>4064230</b>	F2	26x3	3/4"			26	18		15	30	30	5	<b>55,14</b>
<b>4064231</b>	F2	32x3	1"			30	21		17	30	15	5	<b>75,14</b>
<b>4064232</b>	F2	40x4	1"1/4			36	25		17	30	10	5	<b>146,45</b>

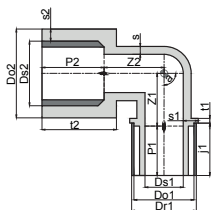

**Gomiti filettati femmina Tigris M1**

Codice	Classe	Do1 x Spess.	Do2	L mm	Z mm	Z1 mm	Z2 mm	Z3 mm	P0	P1	Scat.	Conf.	Euro pz.
<b>341608</b>	F2	50x4,5	1"1/2			42	33				6	3	<b>196,55</b>
<b>341809</b>	F2	63x6	2"			48	40				4	2	<b>456,01</b>
* R <b>341910</b>	F2	75x7,5	2"1/2			55	47				2	2	<b>776,81</b>



R Contattare il Customer Service per tempistiche sulla disponibilità - \* Ad esaurimento



**T semplici Tigris M5**

Codice	Classe	Do1 x Spess.	Do2 x Spess.	Do3 x Spess.	L mm	Z1 mm	Z2 mm	Z3 mm	P1=P3	Scat.	Conf.	Euro pz.
<b>4064323</b>	F2	16x2	16x2	16x2	85	17	17	17	25	80	10	<b>29,82</b>
<b>4064325</b>	F2	20x2	20x2	20x2	90	20	20	20	26	40	10	<b>48,40</b>
<b>4064324</b>	F2	20x2,25	20x2,25	20x2,25	90	20	20	20	26	40	10	<b>48,40</b>
<b>4064326</b>	F2	25x2,5	25x2,5	25x2,5	105	22	22	22	30	20	5	<b>68,98</b>
<b>4064327</b>	F2	26x3	26x3	26x3	105	22	22	22	30	20	5	<b>71,07</b>
<b>4064328</b>	F2	32x3	32x3	32x3	112	26	26	26	30	20	5	<b>114,98</b>
<b>4064329</b>	F2	40x4	40x4	40x4	144	31	31	31	31	6	3	<b>209,77</b>

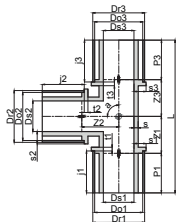

**T semplici Tigris M1**



Codice	Classe	Do1 x Spess.	Do2 x Spess.	Do3 x Spess.	L mm	Z1 mm	Z2 mm	Z3 mm	P1=P3	Scat.	Conf.	Euro pz.
* <b>343007</b>	F2	40x4	40x4	40x4	144	34	34	34		6	3	<b>209,77</b>
<b>343008</b>	F2	50x4,5	50x4,5	50x4,5	154	39	39	39		4	2	<b>292,51</b>
<b>343009</b>	F2	63x6	63x6	63x6	216	48	48	48		2	1	<b>619,12</b>
* <b>343010</b>	F2	75x7,5	75x7,5	75x7,5	224	51	51	51		2	1	<b>762,27</b>

\* Ad esaurimento



**T ridotti Tigris M5**

Codice	Classe	Do1x Spess.	Do2x Spess.	Do3x Spess.	L mm	Z1 mm	Z2 mm	Z3 mm	P1=P3	Scat.	Conf.	Euro pz.
<b>4064356</b>	F2	20x2	16x2	16x2	86	18	19	18		40	10	<b>48,11</b>
<b>4064357</b>	F2	20x2	16x2	20x2	86	18	19	18		40	10	<b>49,62</b>
<b>4064358</b>	F2	20x2	20x2	16x2	90	20	20	19		40	10	<b>44,16</b>
<b>4064353</b>	F2	20x2,25	16x2	16x2	86	18	19	18		40	10	<b>48,11</b>
<b>4064354</b>	F2	20x2,25	16x2	20x2,25	86	18	19	18		40	10	<b>49,62</b>
<b>4064355</b>	F2	20x2,25	20x2,25	16x2	90	20	20	19		40	10	<b>44,16</b>
<b>4064361</b>	F2	25x2,5	16x2	25x2,5	96	18	22	18		20	5	<b>56,92</b>
<b>4064359</b>	F2	25x2,5	20x2,25	20x2,25	95	20	22	20		20	5	<b>57,71</b>
<b>4064362</b>	F2	25x2,5	20x2,25	25x2,5	100	20	22	20		20	5	<b>64,05</b>
<b>4064367</b>	F2	26x3	16x2	26x3	96	18	22	18		20	5	<b>61,71</b>
<b>4064368</b>	F2	26x3	20x2	20x2	95	20	22	20		20	5	<b>63,47</b>
<b>4064369</b>	F2	26x3	20x2	26x3	100	20	22	20		20	5	<b>66,68</b>
<b>4064376</b>	F2	32x3	20x2	32x3	100	20	26	20		20	5	<b>104,87</b>
<b>4064372</b>	F2	32x3	20x2,25	32x3	100	20	26	20		20	5	<b>104,87</b>
* <b>4064375</b>	F2	32x3	20x2,25	25x2,5	100	20	26	20		20	5	<b>100,92</b>
<b>4064373</b>	F2	32x3	25x2,5	25x2,5	105	22	26	22		20	5	<b>100,94</b>
<b>4064374</b>	F2	32x3	25x2,5	32x3	105	22	26	22		20	5	<b>102,86</b>
<b>4064377</b>	F2	32x3	26x3	26x3	105	22	26	22		20	5	<b>102,37</b>
<b>4064378</b>	F2	32x3	26x3	32x3	105	22	26	22		20	5	<b>103,82</b>
<b>4064384</b>	F2	40x4	20x2	40x4	130	23	20	23		20	5	<b>186,90</b>
<b>4064380</b>	F2	40x4	25x2,5	40x4	130	23	20	23		10	5	<b>189,68</b>
<b>4064385</b>	F2	40x4	26x3	40x4	130	23	20	23		10	5	<b>194,70</b>
<b>4064381</b>	F2	40x4	32x3	40x4	137	27	30	27		10	5	<b>197,48</b>

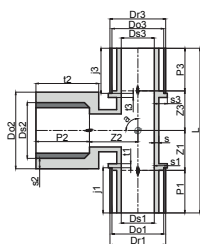

\* Ad esaurimento

**T ridotti Tigris M1**



Codice	Classe	Do1 x Spess.	Do2 x Spess.	Do3 x Spess.	L mm	Z1 mm	Z2 mm	Z3 mm	P1=P3	Scat.	Conf.	Euro pz.
<b>343878</b>	F2	50x4,5	40x4	50x4,5	144	34	34	34		4	2	<b>237,53</b>
<b>343979</b>	F2	63x6	40x4	63x6	188	34	34	34		4	2	<b>447,95</b>
* <b>343989</b>	F2	63x6	50x4,5	63x6	196	38	45	38		4	2	<b>580,92</b>
* <b>R 343161</b>	F2	75x7,5	32x3	75x7,5	178	28	49	28		2	1	<b>624,68</b>
* <b>343171</b>	F2	75x7,5	40x4	75x7,5	188	33	51	33		2	1	<b>705,57</b>
* <b>R 343181</b>	F2	75x7,5	50x4,5	75x7,5	196	38	51	38		2	1	<b>768,75</b>
* <b>343191</b>	F2	75x7,5	63x6	75x7,5	212	45	51	45		2	1	<b>890,22</b>

**T filettati maschio Tigris M5**

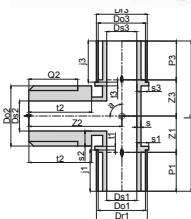

Codice	Classe	Do1 x Spess.	Ds2	Do3 x Spess.	L mm	Z mm	Z1=Z3 mm	Z2 mm	Scat.	Conf.	Euro pz.
<b>4064343</b>	F2	16x2	1/2"	16x2	90		20	13	40	10	<b>32,29</b>
<b>4064346</b>	F2	20x2	1/2"	20x2	90		20	15	40	10	<b>38,19</b>
<b>4064347</b>	F2	20x2	3/4"	20x2	90				40	10	<b>44,74</b>
<b>4064344</b>	F2	20x2,25	1/2"	20x2,25	90		20	15	40	10	<b>40,78</b>

R Contattare il Customer Service per tempistiche sulla disponibilità - \* Ad esaurimento



**T filettati femmina disassati con staffa Tigris M5**

Codice	Classe	Do1 x Spess.	Ds2	Do3 x Spess.	L mm	Z1 mm	Z2 mm	Z3 mm	P0	P1	Scat.	Conf.	Euro pz.
<b>4064398</b>	F2	16x2	1/2"	16x2	111	30			13	25	30	10	<b>61,97</b>
<b>4064400</b>	F2	20x2	1/2"	20x2	112	30			13	26	30	10	<b>71,07</b>
<b>4064399</b>	F2	20x2,25	1/2"	20x2,25	112	30			13	26	30	10	<b>65,33</b>

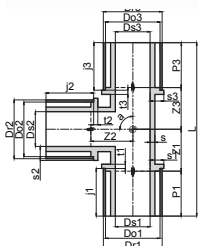

**T filettati femmina Tigris M5**

Codice	Classe	Do1 x Spess.	Ds2	Do3 x Spess.	L mm	Z1 mm	Z2 mm	Z3 mm	P0	P1	Scat.	Conf.	Euro pz.
<b>4064330</b>	F2	16x2	1/2"	16x2	95	22		22			40	10	<b>32,09</b>
<b>4064333</b>	F2	20x2	1/2"	20x2	96	26		26			40	10	<b>42,41</b>
<b>4064334</b>	F2	20x2	3/4"	20x2	103	26		26			40	10	<b>55,87</b>
<b>4064331</b>	F2	20x2,25	1/2"	20x2,25	96	26		26			40	10	<b>42,41</b>
<b>4064332</b>	F2	20x2,25	3/4"	20x2,25	103	26		26			40	10	<b>55,87</b>
<b>4064336</b>	F2	25x2,5	3/4"	25x2,5	113	26		26			20	5	<b>65,29</b>
<b>4064337</b>	F2	26x3	3/4"	26x3	113	26		26			20	5	<b>66,10</b>
<b>4064339</b>	F2	32x3	1"	32x3	121	30		30			20	5	<b>104,97</b>
<b>4064341</b>	F2	40x4	1"	40x4	146	31		31			10	5	<b>174,47</b>

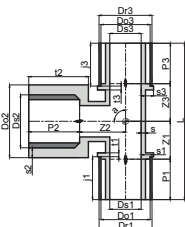

**T filettati femmina Tigris M1**

Codice	Classe	Do1 x Spess.	Ds2	Do3 x Spess.	L mm	Z1 mm	Z2 mm	Z3 mm	P0	P1	Scat.	Conf.	Euro pz.
<b>343408</b>	F2	50x4,5	1"	50x4,5	142	33		33			8	2	<b>226,69</b>
* <b>343608</b>	F2	50x4,5	1"1/2	50x4,5	160	42		42			4	2	<b>305,20</b>
<b>343809</b>	F2	63x6	2"	63x6	220	50		50			3	1	<b>525,94</b>
* <b>343910</b>	F2	75x7,5	2"1/2	75x7,5	232	55		55			2	1	<b>954,86</b>

\* Ad esaurimento



**Bocchettoni Tigris M5**

Codice	Classe	Do1 x Spess.	Ds2	Do3 x Spess.	L mm	Z1 mm	Z2 mm	Z3 mm	P0	P1	Scat.	Conf.	Euro pz.
<b>4064299</b>	F2	16x2	1/2"		67		33				80	10	<b>37,94</b>
<b>4064305</b>	F2	20x2	1/2"		68		33				80	10	<b>42,75</b>
<b>4064306</b>	F2	20x2	3/4"		66		27				80	10	<b>44,63</b>
<b>4064302</b>	F2	20x2,25	1/2"		68		33				80	10	<b>42,75</b>
<b>4064303</b>	F2	20x2,25	3/4"		66		27				80	10	<b>44,63</b>
<b>4064307</b>	F2	25x2,5	3/4"		77		36				40	5	<b>92,14</b>
<b>4064308</b>	F2	25x2,5	1"		74		30				40	5	<b>91,27</b>
<b>4064310</b>	F2	26x3	3/4"		77		36				40	5	<b>93,58</b>
<b>4064311</b>	F2	32x3	1"		81		39				40	5	<b>105,58</b>

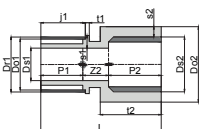

**Terminali filettati femmina Tigris M5**

Codice	Classe	A Ø x Spess.	RP	Do3 x Spess.	L mm	Z1 mm	Z2 mm	Z3 mm	P0	P1	Scat.	Conf.	Euro pz.
<b>4064416</b>	F2	16x2	1/2"								100	10	<b>46,72</b>
<b>4064418</b>	F2	20x2	1/2"								30	10	<b>57,91</b>
<b>4064417</b>	F2	20x2,25	1/2"								50	10	<b>57,91</b>

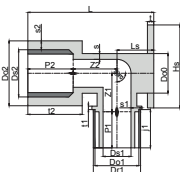

**Terminali filettati femmina doppi con staffa Tigris M5**

Codice	Classe	Do1 x Spess.	Do3	Do2 x Spess.	Z mm	Z1 mm	Z2 mm	Z3 mm	P0 mm	P1	Scat.	Conf.	Euro pz.
<b>4064412</b>	F2	16x2	1/2"	16x2	25	42	42	7			30	10	<b>67,85</b>
<b>4064414</b>	F2	20x2	1/2"	20x2	25	42	42	7			30	10	<b>82,17</b>
<b>4064413</b>	F2	20x2,25	1/2"	20x2,25	25	42	42	7			30	10	<b>71,70</b>

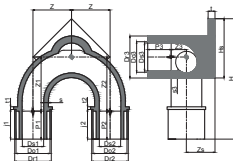

**Terminali filettati femmina con staffa Tigris M5**

Codice	Classe	Do1 x Spess.	Ds2	L mm	Z mm	Z1 mm	Z2 mm	Z3 mm	P0 mm	P1	Scat.	Conf.	Euro pz.
<b>4064404</b>	F2	16x2	1/2"								30	10	<b>38,63</b>
<b>4064409</b>	F2	20x2	1/2"	40,5		23	6				30	10	<b>40,55</b>
<b>4064406</b>	F2	20x2,25	1/2"	40,5		23	6				30	10	<b>40,55</b>

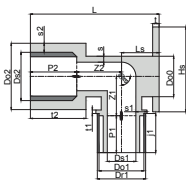





**Kit preassemblati due terminali con staffa Tigris M5**

Codice	Classe	A Ø x Spess.	B RP	Z	Z1 mm	Z2 mm	Z3 mm	P0 mm	P1	Scat.	Conf.	Euro pz.
<b>4064457</b>	F2	16x2	1/2"	153						24	2	<b>57,55</b>
<b>4064459</b>	F2	20x2	1/2"	153						20	2	<b>75,22</b>
<b>4064458</b>	F2	20x2,25	1/2"	153						20	2	<b>75,22</b>

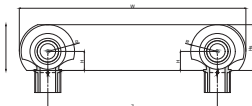

**Rubinetti ad incasso con cappuccio Tigris M5**

Codice	Classe	A Ø x Spess.	B Ø x Spess	L mm	Z	Z1 mm	Z2 mm	Z3 mm	P0 mm	P1	Scat.	Conf.	Euro pz.
<b>4064428</b>	F2	16x2	16x2								24	2	<b>117,72</b>
<b>4064430</b>	F2	20x2	20x2								24	2	<b>122,56</b>
<b>4064429</b>	F2	20x2,25	20x2,25								24	2	<b>122,56</b>

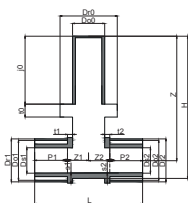

**Accessori rubinetti ad incasso con cappuccio Tigris M5**

Codice	Classe	Descrizione	Scat.	Conf.	Euro pz.
<b>360170</b>	F2	Prolunga di ricambio per rubinetto incasso		1	<b>29,46</b>
<b>360171</b>	F2	Cappuccio e canotto di ricambio per rubinetto incasso		1	<b>40,34</b>



**Manicotti di riparazione**

Codice	Classe	Do1 x Spess.	Ø x Spess	L mm	Z	Z1 mm	Z2 mm	Z3 mm	P0 mm	P1	Scat.	Conf.	Euro pz.
<b>4064431</b>	F2	16x2	16x2								40	5	<b>139,37</b>
<b>4064432</b>	F2	20x2.25	20x2.25								40	5	<b>212,90</b>



**Gomito 90° per radiatore Tigris M5**

Codice	Classe	Do1 x Spess.	Ø x Spess	L mm	Z	Z1 mm	Z2 mm	Z3 mm	P0 mm	P1	Scat.	Conf.	Euro pz.
<b>4064239</b>	F2	16x2	15x1	300		55					10	5	<b>73,34</b>

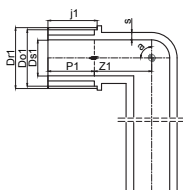



**Tappi prova impianto**

Codice	Classe	Descrizione	Conf.	Euro pz.
<b>609945</b>	X4	Rosso 1/2"	100	<b>1,32</b>
<b>609946</b>	X4	Blu 1/2"	100	<b>1,32</b>
<b>609947</b>	X4	Rosso 3/4"	100	<b>3,54</b>
<b>609948</b>	X4	Blu 3/4"	100	<b>3,54</b>



**Dima multipla**

Codice	Classe	Descrizione	Misure interasse mm	Conf.	Euro pz.
<b>360040</b>	X4	75 x 155 mm	75/155	10	<b>4,26</b>

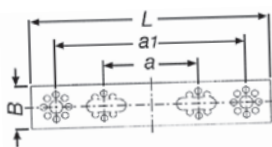

**Dima speciale angolata multipla**

Codice	Classe	L mm	L1 mm	L2 mm	L3 mm	B mm	S mm	a mm	a1 mm	Conf.	Euro pz.
<b>649907</b>	F4	423	253	85	50	50	2	76,5	153	10	<b>26,11</b>

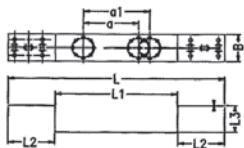

## Collettori



### Lineari senza manopole, uscite da 1/2"

Codice	Classe	Modello	L	Conf.	Euro pz.
<b>360302</b>	F2	2 vie	89	2	<b>39,38</b>
<b>360303</b>	F2	3 vie	127	2	<b>54,34</b>
<b>360304</b>	F2	4 vie	165	2	<b>72,44</b>

Nota: uscite collettore con filettatura gas



### Con manopole, uscite da 1/2"

Codice	Classe	Modello	L	Conf.	Euro pz.
<b>360342</b>	F2	2 vie	86	2	<b>69,95</b>
<b>360343</b>	F2	3 vie	122	2	<b>109,06</b>
<b>360344</b>	F2	4 vie	160	2	<b>135,35</b>

### Con manopole, uscite da 3/4"

Codice	Classe	Modello	L	Conf.	Euro pz.
<b>360352</b>	F2	2 vie	102	2	<b>86,55</b>
<b>360353</b>	F2	3 vie	146	2	<b>127,29</b>

### Accessori collettore con manopole

	Codice	Classe	Descrizione	Conf.	Euro pz.
R	<b>4080030</b>	F2	Vitone G3/8	1	<b>13,53</b>
R	<b>4080031</b>	F2	Manopola bianca	1	<b>3,02</b>
R	<b>4080032</b>	F2	Dischetto reversibile rosso-blu	1	<b>3,02</b>
R	<b>4080033</b>	F2	Dischetto utenza ITA-ENG	1	<b>3,02</b>
R	<b>4080034</b>	F2	Vite M4 X 8	1	<b>3,02</b>

R Contattare il Customer Service per tempistiche sulla disponibilità



**Adattatori**

Codice	Classe	Ø	Conf.	Euro pz.
* <b>360361</b>	F2	1/2" x 14	10	<b>13,12</b>
<b>360362</b>	F2	1/2" x 16	10	<b>15,52</b>
<b>360375</b>	F2	3/4" x 20(2,0)	10	<b>15,80</b>
<b>360374</b>	F2	3/4" x 20	10	<b>15,80</b>

\* Ad esaurimento



**Tappi per collettori**

Codice	Classe	Descrizione	Conf.	Euro pz.
<b>360396</b>	F2	1/2" filettato femmina per uscite	10	<b>10,00</b>
<b>360391</b>	F2	3/4" filettato femmina per estremità e per uscite	10	<b>10,15</b>
<b>360395</b>	F2	3/4" filettato maschio per ingresso	10	<b>10,85</b>



**Cassette per collettori**

Codice	Classe	Descrizione	Dimensioni (H x L x P)	Scat.	Conf.	Euro pz.
<b>360386</b>	X4	Cassetta per collettore	300 x 250 x 95	11	1	<b>25,42</b>
<b>360387</b>	X4	Cassetta per collettore	400 x 250 x 95	8	1	<b>28,32</b>
<b>360388</b>	X4	Cassetta per collettore	480 x 250 x 95	7	1	<b>34,13</b>



**Staffe per collettori**

Codice	Classe	Modello	Conf.	Euro coppia
<b>360389</b>	X4	Staffe per collettori lineari altezza differenziata uscita dal basso	coppia	<b>4,52</b>



# Profili

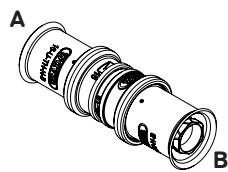

## Manicotti Tigris M5

Codice	A Ø x Spess.	A Profilo	B Ø x Spess.	B Profilo
<b>4063971</b>	16x2	U-H-TH-B-UP	16x2	U-H-TH-B-UP
<b>4063973</b>	20x2	U-H-TH-B-UP	20x2	U-H-TH-B-UP
<b>4063972</b>	20x2,25	U-H-TH-B-UP	20x2,25	U-H-TH-B-UP
<b>4063974</b>	25x2,5	U-H-TH-UP	25x2,5	U-H-TH-UP
<b>4063975</b>	26x3	H-TH-B	26x3	H-TH-B
<b>4064166</b>	32x3	U-H-TH-B-UP	32x3	U-H-TH-B-UP
<b>4064167</b>	40x4	U-TH-UP	40x4	U-TH-UP

## Manicotti Tigris M1

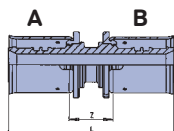

Codice	A Ø x Spess.	A Profilo	B Ø x Spess.	B Profilo
<b>345007</b>	40x4	U	40x4	U
<b>345008</b>	50x4,5	U	50x4,5	U
<b>345009</b>	63x6	U	63x6	U
<b>345010</b>	75x7,5	U	75x7,5	U

## Manicotti ridotti Tigris M5

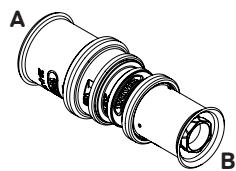

Codice	A Ø x Spess.	A Profilo	B Ø x Spess.	B Profilo
<b>4064183</b>	20x2	U-H-TH-B-UP	16x2	U-H-TH-B-UP
<b>4064182</b>	20x2,25	U-H-TH-B-UP	16x2	U-H-TH-B-UP
<b>4064185</b>	25x2,5	U-H-TH-UP	20x2,25	U-H-TH-B-UP
<b>4064186</b>	26x3	H-TH-B	20x2	U-H-TH-B-UP
<b>4064187</b>	26x3	H-TH-B	25x2,5	U-H-TH-UP
<b>4064190</b>	32x3	U-H-TH-B-UP	25x2,5	U-H-TH-UP
<b>4064191</b>	32x3	U-H-TH-B-UP	26x3	H-TH-B
<b>4064192</b>	40x4	U-TH-UP	25x2,5	U-H-TH-UP
<b>4064193</b>	40x4	U-TH-UP	32x3	U-H-TH-B-UP

## Manicotti ridotti Tigris M1

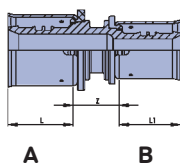

Codice	A Ø x Spess.	A Profilo	B Ø x Spess.	B Profilo
<b>345087</b>	50x4,5	U	40x4	U
<b>345097</b>	63x6	U	40x4	U
<b>345098</b>	63x6	U	50x4,5	U
<b>345109</b>	75x7,5	U	63x6	U

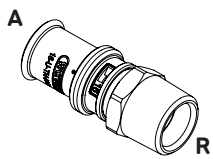

**Manicotti filettati maschio Tigris M5**

Codice	A Ø x Spess.	A Profilo	R
4064263	16x2	U-H-TH-B-UP	1/2"
4064268	20x2	U-H-TH-B-UP	1/2"
4064269	20x2	U-H-TH-B-UP	3/4"
4064265	20x2,25	U-H-TH-B-UP	1/2"
4064266	20x2,25	U-H-TH-B-UP	3/4"
4064270	25x2,5	U-H-TH-UP	3/4"
4064271	25x2,5	U-H-TH-UP	1"
4064272	26x3	H-TH-B	3/4"
4064273	32x3	U-H-TH-B-UP	1"
4064276	40x4	U-TH-UP	1"1/4

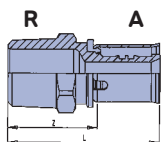

**Manicotti filettati maschio Tigris M1**

Codice	A Ø x Spess.	A Profilo	R
345860	50x4,5	U	1"1/2
345980	63x6	U	2"
345190	75x7,5	U	2"1/2

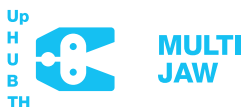
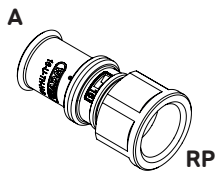

**Manicotti filettati femmina Tigris M5**

Codice	A Ø x Spess.	A Profilo	RP
4064245	16x2	U-H-TH-B-UP	1/2"
4064250	20x2	U-H-TH-B-UP	1/2"
4064251	20x2	U-H-TH-B-UP	3/4"
4064247	20x2,25	U-H-TH-B-UP	1/2"
4064248	20x2,25	U-H-TH-B-UP	3/4"
4064252	25x2,5	U-H-TH-UP	3/4"
4064255	26x3	H-TH-B	1"
4064254	26x3	H-TH-B	3/4"
4064256	32x3	U-H-TH-B-UP	1"
4064259	40x4	U-TH-UP	1"1/4

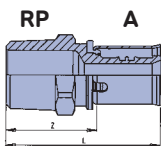

**Manicotti filettati femmina Tigris M1**

Codice	A Ø x Spess.	A Profilo	RP
345608	50x4,5	U	1"1/2
345809	63x6	U	2"

**Gomiti 45° Tigris M5**

Codice	A Ø x Spess.	A Profilo	B Ø x Spess.	B Profilo
<b>4064208</b>	40x4	U-TH-UP	40x4	U-TH-UP

**Gomiti 45° Tigris M1**

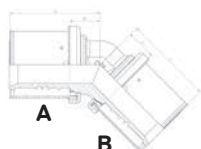

Codice	A Ø x Spess.	A Profilo	B Ø x Spess.	B Profilo
<b>341508</b>	50x4,5	U	50x4,5	U
<b>341509</b>	63x6	U	63x6	U
<b>341510</b>	75x7,5	U	75x7,5	U

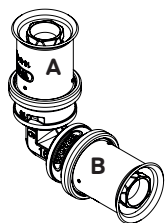

**Gomiti 90° Tigris M5**

Codice	A Ø x Spess.	A Profilo	B Ø x Spess.	B Profilo
<b>4064199</b>	16x2	U-H-TH-B-UP	16x2	U-H-TH-B-UP
<b>4064201</b>	20x2	U-H-TH-B-UP	20x2	U-H-TH-B-UP
<b>4064200</b>	20x2,25	U-H-TH-B-UP	20x2,25	U-H-TH-B-UP
<b>4064202</b>	25x2,5	U-H-TH-UP	25x2,5	U-H-TH-UP
<b>4064203</b>	26x3	H-TH-B	26x3	H-TH-B
<b>4064204</b>	32x3	U-H-TH-B-UP	32x3	U-H-TH-B-UP
<b>4064205</b>	40x4	U-TH-UP	40x4	U-TH-UP

**Gomiti 90° Tigris M1**

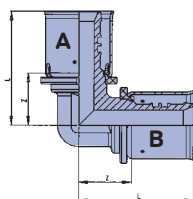

Codice	A Ø x Spess.	A Profilo	B Ø x Spess.	B Profilo
<b>345707</b>	40x4	U	40x4	U
<b>345608</b>	50x4,5	U	50x4,5	U
<b>345809</b>	63x6	U	63x6	U
<b>341010</b>	75x7,5	U	75x7,5	U

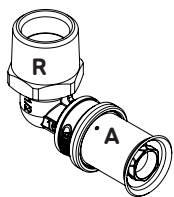

**Gomiti filettati maschio Tigris M5**

Codice	A Ø x Spess.	A Profilo	R
<b>4064210</b>	16x2	U-H-TH-B-UP	1/2"
<b>4064214</b>	20x2	U-H-TH-B-UP	1/2"
<b>4064215</b>	20x2	U-H-TH-B-UP	3/4"
<b>4064212</b>	20x2,25	U-H-TH-B-UP	1/2"
<b>4064213</b>	20x2,25	U-H-TH-B-UP	3/4"
<b>4064216</b>	25x2,5	U-H-TH-UP	3/4"
<b>4064218</b>	26x3	H-TH-B	3/4"
<b>4064219</b>	32x3	U-H-TH-B-UP	1"
<b>4064220</b>	40x4	U-TH-UP	1"1/4

**Gomiti filettati maschio Tigris M1**

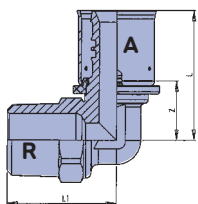

Codice	A Ø x Spess.	A Profilo	R
<b>341750</b>	40x4	U	1"1/4
<b>341860</b>	50x4,5	U	1"1/2
<b>341980</b>	63x6	U	2"
<b>341190</b>	75x7,5	U	2"1/2

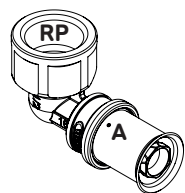

**Gomiti filettati femmina Tigris M5**

Codice	A Ø x Spess.	A Profilo	RP
<b>4064222</b>	16x2	U-H-TH-B-UP	1/2"
<b>4064226</b>	20x2	U-H-TH-B-UP	1/2"
<b>4064227</b>	20x2	U-H-TH-B-UP	3/4"
<b>4064224</b>	20x2,25	U-H-TH-B-UP	1/2"
<b>4064225</b>	20x2,25	U-H-TH-B-UP	3/4"
<b>4064228</b>	25x2,5	U-H-TH-UP	3/4"
<b>4064230</b>	26x3	H-TH-B	3/4"
<b>4064231</b>	32x3	U-H-TH-B-UP	1"
<b>4064232</b>	40x4	U-TH-UP	1"1/4

**Gomiti filettati femmina Tigris M1**

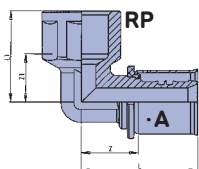

Codice	A Ø x Spess.	A Profilo	RP
<b>341707</b>	40x4	U	1"1/4
<b>341608</b>	50x4,5	U	1"1/2
<b>341809</b>	63x6	U	2"
<b>341910</b>	75x7,5	U	2"1/2



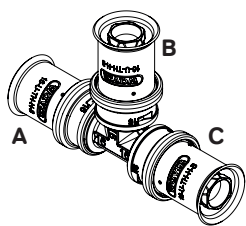

**T semplici Tigris M5**

Codice	A Ø x Spess.	A Profilo	B Ø x Spess.	B Profilo	C Ø x Spess.	C Profilo
<b>4064323</b>	16x2	U-H-TH-B-UP	16x2	U-H-TH-B-UP	16x2	U-H-TH-B-UP
<b>4064325</b>	20x2	U-H-TH-B-UP	20x2	U-H-TH-B-UP	20x2	U-H-TH-B-UP
<b>4064324</b>	20x2,25	U-H-TH-B-UP	20x2,25	U-H-TH-B-UP	20x2,25	U-H-TH-B-UP
<b>4064326</b>	25x2,5	U-H-TH-UP	25x2,5	U-H-TH-UP	25x2,5	U-H-TH-UP
<b>4064327</b>	26x3	H-TH-B	26x3	H-TH-B	26x3	H-TH-B
<b>4064328</b>	32x3	U-H-TH-B-UP	32x3	U-H-TH-B-UP	32x3	U-H-TH-B-UP
<b>4064329</b>	40x4	U-TH-UP	40x4	U-TH-UP	40x4	U-TH-UP

**T semplici Tigris M1**

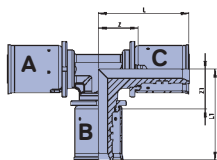

Codice	A Ø x Spess.	A Profilo	B Ø x Spess.	B Profilo	C Ø x Spess.	C Profilo
<b>343007</b>	40x4	U	40x4	U	40x4	U
<b>343008</b>	50x4,5	U	50x4,5	U	50x4,5	U
<b>343009</b>	63x6	U	63x6	U	63x6	U
<b>343010</b>	75x7,5	U	75x7,5	U	75x7,5	U

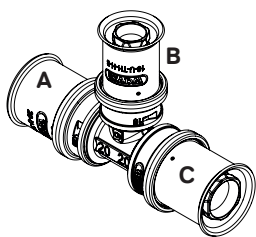

**T ridotti Tigris M5**

Codice	A Ø x Spess.	A Profilo	B Ø x Spess.	B Profilo	C Ø x Spess.	C Profilo
<b>4064356</b>	20x2	U-H-TH-B-UP	16x2	U-H-TH-B-UP	16x2	U-H-TH-B-UP
<b>4064357</b>	20x2	U-H-TH-B-UP	16x2	U-H-TH-B-UP	20x2	U-H-TH-B-UP
<b>4064358</b>	20x2	U-H-TH-B-UP	20x2	U-H-TH-B-UP	16x2	U-H-TH-B-UP
<b>4064353</b>	20x2,25	U-H-TH-B-UP	16x2	U-H-TH-B-UP	16x2	U-H-TH-B-UP
<b>4064354</b>	20x2,25	U-H-TH-B-UP	16x2	U-H-TH-B-UP	20x2,25	U-H-TH-B-UP
<b>4064355</b>	20x2,25	U-H-TH-B-UP	20x2,25	U-H-TH-B-UP	16x2	U-H-TH-B-UP
<b>4064359</b>	25x2,5	U-H-TH-UP	20x2,25	U-H-TH-B-UP	20x2,25	U-H-TH-B-UP
<b>4064361</b>	25x2,5	U-H-TH-UP	16x2	U-H-TH-B-UP	25x2,5	U-H-TH-UP
<b>4064362</b>	25x2,5	U-H-TH-UP	20x2,25	U-H-TH-B-UP	25x2,5	U-H-TH-UP
<b>4064367</b>	26x3	H-TH-B	16x2	U-H-TH-B-UP	26x3	H-TH-B
<b>4064368</b>	26x3	H-TH-B	20x2	U-H-TH-B-UP	20x2	U-H-TH-B-UP
<b>4064369</b>	26x3	H-TH-B	20x2	U-H-TH-B-UP	26x3	H-TH-B
<b>4064372</b>	32x3	U-H-TH-B-UP	20x2,25	U-H-TH-B-UP	32x3	U-H-TH-B-UP
<b>4064373</b>	32x3	U-H-TH-B-UP	25x2,5	U-H-TH-UP	25x2,5	U-H-TH-UP
<b>4064374</b>	32x3	U-H-TH-B-UP	25x2,5	U-H-TH-UP	32x3	U-H-TH-B-UP
<b>4064375</b>	32x3	U-H-TH-B-UP	20x2,25	U-H-TH-B-UP	25x2,5	U-H-TH-UP
<b>4064376</b>	32x3	U-H-TH-B-UP	20x2	U-H-TH-B-UP	32x3	U-H-TH-B-UP
<b>4064377</b>	32x3	U-H-TH-B-UP	26x3	H-TH-B	26x3	H-TH-B
<b>4064378</b>	32x3	U-H-TH-B-UP	26x3	H-TH-B	32x3	U-H-TH-B-UP
<b>4064384</b>	40x4	U-TH-UP	20x2	U-H-TH-B-UP	40x4	U-TH-UP
<b>4064380</b>	40x4	U-TH-UP	25x2,5	U-H-TH-UP	40x4	U-TH-UP
<b>4064385</b>	40x4	U-TH-UP	26x3	H-TH-B	40x4	U-TH-UP
<b>4064381</b>	40x4	U-TH-UP	32x3	U-H-TH-B-UP	40x4	U-TH-UP

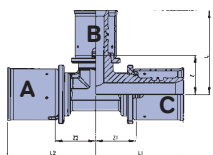

**T ridotti Tigris M1**

Codice	A Ø x Spess.	A Profilo	B Ø x Spess.	B Profilo	C Ø x Spess.	C Profilo
<b>343757</b>	40x4	U	25x2,5	U	40x4	U
<b>343767</b>	40x4	U	32x3	U	40x4	U
<b>343878</b>	50x4,5	U	40x4	U	50x4,5	U
<b>343979</b>	63x6	U	40x4	U	63x6	U
<b>343989</b>	63x6	U	50x4,5	U	63x6	U
<b>343161</b>	75x7,5	U	32x3	U	75x7,5	U
<b>343171</b>	75x7,5	U	40x4	U	75x7,5	U
<b>343181</b>	75x7,5	U	50x4,5	U	75x7,5	U
<b>343191</b>	75x7,5	U	63x6	U	75x7,5	U

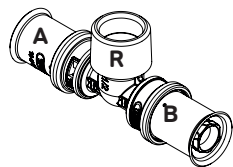

**T filettati maschio Tigris M5**

Codice	A Ø x Spess.	A Profilo	R	B Ø x Spess.	B Profilo
<b>4064343</b>	16x2	U-H-TH-B-UP	1/2"	16x2	U-H-TH-B-UP
<b>4064346</b>	20x2	U-H-TH-B-UP	1/2"	20x2	U-H-TH-B-UP
<b>4064347</b>	20x2	U-H-TH-B-UP	3/4"	20x2	U-H-TH-B-UP
<b>4064344</b>	20x2,25	U-H-TH-B-UP	1/2"	20x2,25	U-H-TH-B-UP

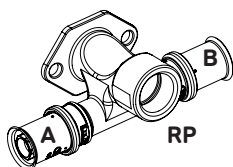

**T filettati femmina disassati con staffa Tigris M5**

Codice	A Ø x Spess.	A Profilo	RP	B Ø x Spess.	B Profilo
<b>4064398</b>	16x2	U-H-TH-B-UP	1/2"	16x2	U-H-TH-B-UP
<b>4064400</b>	20x2	U-H-TH-B-UP	1/2"	20x2	U-H-TH-B-UP
<b>4064399</b>	20x2,25	U-H-TH-B-UP	1/2"	20x2,25	U-H-TH-B-UP

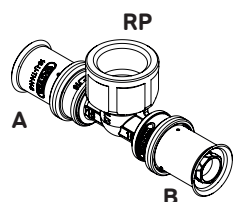

**T filettati femmina Tigris M5**

Codice	A Ø x Spess.	A Profilo	RP	B Ø x Spess.	C Profilo
<b>4064330</b>	16x2	U-H-TH-B-UP	1/2"	16x2	U-H-TH-B-UP
<b>4064333</b>	20x2	U-H-TH-B-UP	1/2"	20x2	U-H-TH-B-UP
<b>4064334</b>	20x2	U-H-TH-B-UP	3/4"	20x2	U-H-TH-B-UP
<b>4064331</b>	20x2,25	U-H-TH-B-UP	1/2"	20x2,25	U-H-TH-B-UP
<b>4064332</b>	20x2,25	U-H-TH-B-UP	3/4"	20x2,25	U-H-TH-B-UP
<b>4064336</b>	25x2,5	U-H-TH-UP	3/4"	25x2,5	U-H-TH-UP
<b>4064337</b>	26x3	H-TH-B	3/4"	26x3	H-TH-B
<b>4064339</b>	32x3	U-H-TH-B-UP	1"	32x3	U-H-TH-B-UP
<b>4064331</b>	40x4	U-TH-UP	1"	40x4	U-TH-UP

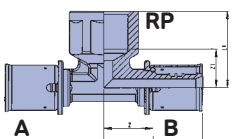

**T filettati femmina Tigris M1**

Codice	A Ø x Spess.	A Profilo	RP	B Ø x Spess.	B Profilo
<b>343408</b>	50x4,5	U	1"	50x4,5	U
<b>343608</b>	50x4,5	U	1"1/2	50x4,5	U
<b>343809</b>	63x6	U	2"	63x6	U
<b>343910</b>	75x7,5	U	2"1/2	75x7,5	U

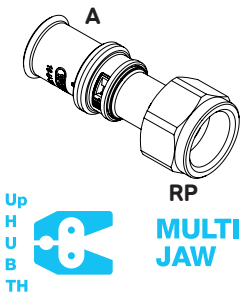

**Bocchettoni Tigris M5**

Codice	A Ø x Spess.	A Profilo	RP
4064299	16x2	U-H-TH-B-UP	1/2"
4064305	20x2	U-H-TH-B-UP	1/2"
4064306	20x2	U-H-TH-B-UP	3/4"
4064302	20x2,25	U-H-TH-B-UP	1/2"
4064303	20x2,25	U-H-TH-B-UP	3/4"
4064307	25x2,5	U-H-TH-UP	3/4"
4064308	25x2,5	U-H-TH-UP	1"
4064310	26x3	H-TH-B	3/4"
4064311	32x3	U-H-TH-B-UP	1"

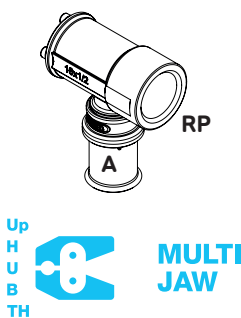

**Terminali Tigris M5**

Codice	A Ø x Spess.	A Profilo	RP
4064416	16x2	U-H-TH-B-UP	1/2"
4064418	20x2	U-H-TH-B-UP	1/2"
4064417	20x2,25	U-H-TH-B-UP	1/2"

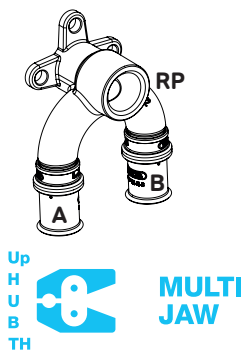

**Terminali filettati femmina doppi con staffa Tigris M5**

Codice	A Ø x Spess.	A Profilo	RP	B Ø x Spess.	B Profilo
4064412	16x2	U-H-TH-B-UP	1/2"	16x2	U-H-TH-B-UP
4064414	20x2	U-H-TH-B-UP	1/2"	20x2	U-H-TH-B-UP
4064413	20x2,25	U-H-TH-B-UP	1/2"	20x2,25	U-H-TH-B-UP

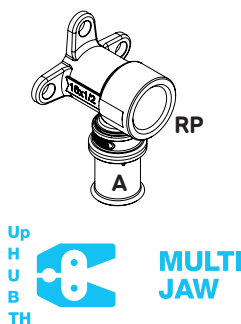

**Terminali filettato femmina con staffa Tigris M5**

Codice	A Ø x Spess.	A Profilo	RP
4064404	16x2	U-H-TH-B-UP	1/2"
4064409	20x2	U-H-TH-B-UP	1/2"
4064406	20x2,25	U-H-TH-B-UP	1/2"

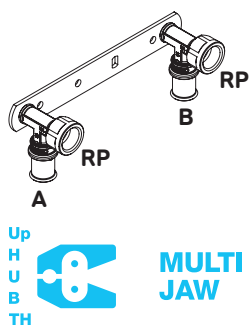

**Kit preassemblati due terminali con staffa Tigris M5**

Codice	A Ø x Spess.	A Profilo	RP	B Ø x Spess.	B Profilo	RP
<b>4064457</b>	16x2	U-H-TH-B-UP	1/2"	16x2	U-H-TH-B-UP	1/2"
<b>4064459</b>	20x2	U-H-TH-B-UP	1/2"	20x2	U-H-TH-B-UP	1/2"
<b>4064458</b>	20x2,25	U-H-TH-B-UP	1/2"	20x2,25	U-H-TH-B-UP	1/2"

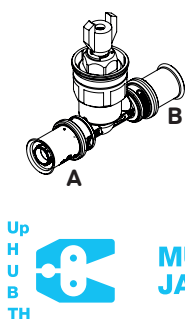

**Rubinetti ad incasso con cappuccio Tigris M5**

Codice	A Ø x Spess.	A Profilo	B Ø x Spess.	B Profilo
<b>4064428</b>	16x2	U-H-TH-B-UP	16x2	U-H-TH-B-UP
<b>4064430</b>	20x2	U-H-TH-B-UP	20x2	U-H-TH-B-UP
<b>4064429</b>	20x2,25	U-H-TH-B-UP	20x2,25	U-H-TH-B-UP



**Manicotti di riparazione**

Codice	A Ø x Spess.	A Profilo	B Ø x Spess.	B Profilo
<b>4064431</b>	16x2	U-H-TH-B-UP	16x2	U-H-TH-B-UP
<b>4064432</b>	20x2,25	U-H-TH-B-UP	20x2,25	U-H-TH-B-UP

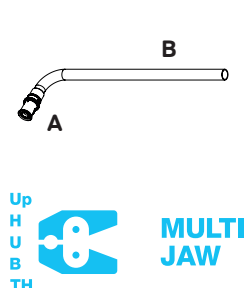

**Gomito 90°per radiatore M5**

Codice	A Ø x Spess.	A Profilo	B Ø x Spess.
<b>4064239</b>	16x2	U-H-TH-B-UP	15x1



# Wavin Tigris K5 - K1





**Manicotti Tigris K5**

Codice	Classe	Do1 x Spess.	Do2 x Spess.	L mm	Z mm	Z1 mm	Z2 mm	Z3 mm	PO	P1	Scat.	Conf.	Euro pz.
<b>3079754</b>	F4	16x2	16x2	68			18				60	10	<b>8,23</b>
<b>3079755</b>	F4	20x2,25	20x2,25	69			17				50	10	<b>9,69</b>
<b>3079756</b>	F4	25x2,5	25x2,5	78			18				40	10	<b>15,82</b>
<b>3079757</b>	F4	32x3	32x3	78			18				20	5	<b>25,53</b>
<b>3079758</b>	F4	40x4	40x4	100			19				8	2	<b>39,30</b>

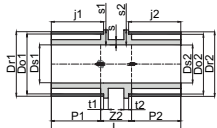

**Manicotti Tigris K1**

Codice	Classe	Do1 x Spess.	Do2 x Spess.	L mm	Z mm	Z1 mm	Z2 mm	Z3 mm	PO	P1	Scat.	Conf.	Euro pz.
<b>645008</b>	F4	50x4,5	50x4,5	108			33				8	2	<b>72,60</b>
<b>645009</b>	F4	63x6	63x6	155			35				2	2	<b>166,89</b>
<b>645010</b>	F4	75x7,5	75x7,5	157			33				2	2	<b>215,94</b>



**Manicotti ridotti Tigris K5**

Codice	Classe	Do1 x Spess.	Do2 x Spess.	L mm	Z mm	Z1 mm	Z2 mm	Z3 mm	PO	P1	Scat.	Conf.	Euro pz.
<b>3079759</b>	F4	20x2	16x2	70			19				60	10	<b>9,96</b>
<b>3079760</b>	F4	25x2,5	16x2	75			19				40	10	<b>14,10</b>
<b>3079761</b>	F4	25x2,5	20x2,25	75			19				40	10	<b>16,48</b>
<b>3079762</b>	F4	32x3	20x2,25	75			19				20	5	<b>21,07</b>
<b>3079763</b>	F4	32x3	25x2,5	80			19				20	5	<b>24,45</b>
<b>3079764</b>	F4	40x4	32x3	91			19				8	2	<b>34,31</b>

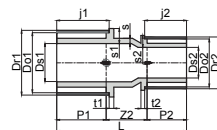

**Manicotti ridotti Tigris K1**

Codice	Classe	Do1 x Spess.	Do2 x Spess.	L mm	Z mm	Z1 mm	Z2 mm	Z3 mm	PO	P1	Scat.	Conf.	Euro pz.
<b>645086</b>	F4	50x4,5	32x3	64			28				10	2	<b>57,10</b>
<b>645087</b>	F4	50x4,5	40x4	76			35				8	2	<b>67,20</b>
<b>R 645097</b>	F4	63x6	40x4	98			42				2	2	<b>175,29</b>
<b>645098</b>	F4	63x6	50x4,5	98			36				2	2	<b>175,29</b>
<b>R 645108</b>	F4	75x7,5	50x4,5	101			27				2	2	<b>186,38</b>
<b>R 645109</b>	F4	75x7,5	63x6	123			31				2	2	<b>223,5</b>

R Contattare il Customer Service per tempistiche sulla disponibilità





**Manicotti filettati maschio Tigris K5**

Codice	Classe	Do1 x Spess.	Do2	L mm	Z mm	Z1 mm	Z2 mm	Z3 mm	P0	P1	Scat.	Conf.	Euro pz.
<b>3079798</b>	F4	16x2	1/2"	58			33				60	10	<b>5,31</b>
<b>3079800</b>	F4	20x2,25	1/2"	63			34				60	10	<b>8,13</b>
<b>3079801</b>	F4	20x2,25	3/4"	60			38				50	10	<b>8,79</b>
<b>3079802</b>	F4	25x2,5	3/4"	68			38				40	10	<b>10,44</b>
<b>3079803</b>	F4	25x2,5	1"	75			45				30	10	<b>15,58</b>
<b>3079804</b>	F4	32x3	1"	81			45				20	5	<b>18,97</b>
<b>3079806</b>	F4	40x4	1"1/4	92			51				8	2	<b>32,49</b>

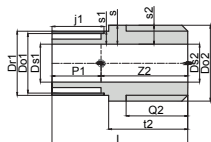

**Manicotti filettati maschio Tigris K1**

Codice	Classe	Do1 x Spess.	Do2	L mm	Z mm	Z1 mm	Z2 mm	Z3 mm	P0	P1	Scat.	Conf.	Euro pz.
<b>645 860</b>	F4	50x4,5	1"1/2	95			57				10	2	<b>76,10</b>

**Manicotti filettati femmina Tigris K5**

Codice	Classe	Do1 x Spess.	Do2	L mm	Z mm	Z1 mm	Z2 mm	Z3 mm	P0	P1	Scat.	Conf.	Euro pz.
<b>3079788</b>	F4	16x2	1/2"	56			14				50	10	<b>8,51</b>
<b>3079790</b>	F4	20x2,25	1/2"	56			13				40	10	<b>10,69</b>
<b>3079791</b>	F4	20x2,25	3/4"	59			15				40	10	<b>12,95</b>
<b>3079793</b>	F4	25x2,5	3/4"	63			15				30	10	<b>14,22</b>
<b>3079796</b>	F4	32x3	1"	67			16				15	5	<b>25,86</b>
<b>3079797</b>	F4	40x4	1"1/4	81			16				8	2	<b>38,22</b>

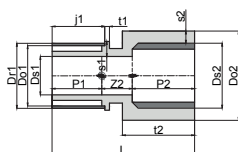

**Gomiti 45° Tigris K5**

Codice	Classe	Do1 x Spess.	Do2 x Spess.	L mm	Z mm	Z1 mm	Z2 mm	Z3 mm	PO	P1= P2	Scat.	Conf.	Euro pz.
<b>3079773</b>	F4	25x2,5	25x2,5			14	14			41	30	10	<b>26,60</b>
<b>3079774</b>	F4	32x3	32x3			15	15			41	20	5	<b>38,21</b>
<b>3079775</b>	F4	40x4	40x4			17	17			41	8	2	<b>56,94</b>



**Gomiti 45° Tigris K1**

Codice	Classe	Do1 x Spess.	Do2 x Spess.	L mm	Z mm	Z1 mm	Z2 mm	Z3 mm	PO	P1= P2	Scat.	Conf.	Euro pz.
<b>641 508</b>	F4	50x4,5	50x4,5			25	25			38	8	2	<b>95,92</b>
<b>641 509</b>	F4	63x6	63x6			28	28			87	2	2	<b>215,80</b>
<b>R 641 510</b>	F4	75x7,5	75x7,5			29	29			91	2	2	<b>268,04</b>

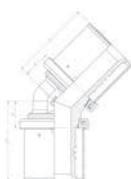

**Gomiti 90° Tigris K5**

Codice	Classe	Do1 x Spess.	Do2 x Spess.	L mm	Z mm	Z1 mm	Z2 mm	Z3 mm	PO	P1	Scat.	Conf.	Euro pz.
<b>3079768</b>	F4	16x2	16x2			17	17				50	10	<b>10,14</b>
<b>3079769</b>	F4	20x2,25	20x2,25			20	20				50	10	<b>14,24</b>
<b>3079770</b>	F4	25x2,5	25x2,5			22	22				30	10	<b>19,99</b>
<b>3079771</b>	F4	32x3	32x3			26	26				15	5	<b>27,85</b>
<b>3079772</b>	F4	40x4	40x4			29	29				8	2	<b>42,76</b>

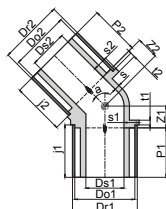

**Gomiti 90° Tigris K1**

Codice	Classe	Do1 x Spess.	Do2 x Spess.	L mm	Z mm	Z1 mm	Z2 mm	Z3 mm	PO	P1	Scat.	Conf.	Euro pz.
<b>641008</b>	F4	50x4,5	50x4,5			40	40				6	2	<b>77,85</b>
<b>641009</b>	F4	63x6	63x6			46	46				2	2	<b>179,24</b>
<b>641010</b>	F4	75x7,5	75x7,5			50	50				2	2	<b>253,26</b>



**Gomiti filettati maschio Tigris K5**

Codice	Classe	Do1 x Spess.	Do2	L mm	Z mm	Z1 mm	Z2 mm	Z3 mm	PO	P1	Scat.	Conf.	Euro pz.
<b>3079776</b>	F4	16x2	1/2"			18	35				60	10	<b>8,62</b>
<b>3079777</b>	F4	20x2,25	1/2"			19	37				50	10	<b>13,27</b>
<b>3079778</b>	F4	20x2,25	3/4"			22	41				30	10	<b>14,10</b>
<b>3079779</b>	F4	25x2,5	3/4"			22	44				30	10	<b>16,92</b>
<b>3079781</b>	F4	32x3	1"			25	54				15	5	<b>32,16</b>

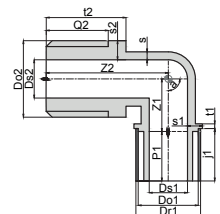

R Contattare il Customer Service per tempistiche sulla disponibilità

**Gomiti filettati femmina Tigris K5**

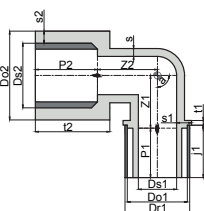

Codice	Classe	Do1 x Spess.	Do2	L mm	Z mm	Z1 mm	Z2 mm	Z3 mm	P0	P1	Scat.	Conf.	Euro pz.
<b>3079782</b>	F4	16x2	1/2"			24	17		13	25	50	10	<b>10,13</b>
<b>3079783</b>	F4	20x2,25	1/2"			24	17		13	26	30	10	<b>14,61</b>
<b>3079784</b>	F4	20x2,25	3/4"			27	18		15	26	30	10	<b>15,56</b>
<b>3079785</b>	F4	25x2,5	3/4"			27	18		15	30	20	10	<b>23,05</b>
<b>3079786</b>	F4	32x3	1"			32	24		17	30	15	5	<b>33,9</b>

**T semplici Tigris K5**

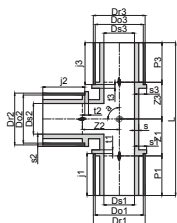

Codice	Classe	Do1 x Spess.	Do2 x Spess.	Do3 x Spess.	L mm	Z1 mm	Z2 mm	Z3 mm	P1=P3	Scat.	Conf.	Euro pz.
<b>3079811</b>	F4	16x2	16x2	16x2	84	17	17	17	25	50	10	<b>12,29</b>
<b>3079812</b>	F4	20x2,25	20x2,25	20x2,25	92	20	20	20	26	30	10	<b>19,31</b>
<b>3079813</b>	F4	25x2,5	25x2,5	25x2,5	104	22	22	22	30	15	5	<b>29,75</b>
<b>3079814</b>	F4	32x3	32x3	32x3	112	26	26	26	30	9	3	<b>37,47</b>
<b>3079815</b>	F4	40x4	40x4	40x4	140	29	29	29	31	4	2	<b>67,38</b>

**T semplici Tigris K1**



Codice	Classe	Do1 x Spess.	Do2 x Spess.	Do3 x Spess.	L mm	Z1 mm	Z2 mm	Z3 mm	P1=P3	Scat.	Conf.	Euro pz.
<b>643008</b>	F4	50x4,5	50x4,5	50x4,5	77	39	39	39		6	2	<b>109,92</b>
<b>643009</b>	F4	63x6	63x6	63x6	106	46	46	46		2	2	<b>247,27</b>
<b>R 643010</b>	F4	75x7,5	75x7,5	75x7,5	112	50	50	50		2	2	<b>327,53</b>

R Contattare il Customer Service per tempistiche sulla disponibilità



**T ridotti Tigris K5**

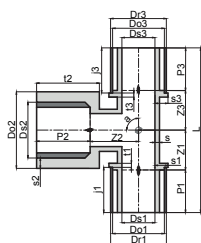

Codice	Classe	Do1 x Spess.	Do2 x Spess.	Do3 x Spess.	L mm	Z1 mm	Z2 mm	Z3 mm	P1=P3	Scat.	Conf.	Euro pz.
<b>3079821</b>	F4	16x2	20x2,25	16x2	88	19	17	19		50	10	<b>19,31</b>
<b>3079822</b>	F4	20x2,25	16x2	16x2	85	17	19	17		40	10	<b>19,07</b>
<b>3079823</b>	F4	20x2,25	16x2	20x2,25	86	17	19	17		40	10	<b>19,64</b>
<b>3079824</b>	F4	20x2,25	20x2,25	16x2	91	20	20	20		40	10	<b>18,90</b>
<b>3079826</b>	F4	20x2,25	25x2,5	20x2,25	94	22	19	22		25	5	<b>24,79</b>
<b>3079829</b>	F4	25x2,5	16x2	16x2	89	17	22	17		30	5	<b>24,79</b>
<b>3079827</b>	F4	25x2,5	16x2	25x2,5	96	18	22	18		25	5	<b>22,71</b>
<b>3079825</b>	F4	25x2,5	20x2,25	20x2,25	95	19	22	20		25	5	<b>23,78</b>
<b>3079828</b>	F4	25x2,5	20x2,25	25x2,5	100	20	22	20		25	5	<b>28,93</b>
<b>3079833</b>	F4	25x2,5	32x3	25x2,5	110	25	22	25		20	5	<b>37,28</b>
<b>3079834</b>	F4	32x3	16x2	32x3	94	17	25	17		15	5	<b>35,22</b>
<b>3079835</b>	F4	32x3	20x2,25	32x3	98	19	26	19		15	5	<b>41,93</b>
<b>3079836</b>	F4	32x3	25x2,5	25x2,5	104	22	26	22		15	5	<b>42,43</b>
<b>3079837</b>	F4	32x3	25x2,5	32x3	104	22	26	22		10	5	<b>42,21</b>
<b>3079841</b>	F4	40x4	25x2,5	32x3	115	22	29	22		6	3	<b>49,23</b>
<b>3079839</b>	F4	40x4	25x2,5	40x4	126	22	29	22		6	2	<b>48,83</b>
<b>3079842</b>	F4	40x4	32x3	32x3	122	26	29	25		6	2	<b>45,75</b>
<b>3079840</b>	F4	40x4	32x3	40x4	122	20	29	20		6	2	<b>57,84</b>



**T ridotti Tigris K1**

Codice	Classe	Do1 x Spess.	Do2 x Spess.	Do3 x Spess.	L mm	Z1 mm	Z2 mm	Z3 mm	P1=P3	Scat.	Conf.	Euro pz.
<b>643858</b>	F4	50x4,5	25x2,5	50x4,5	64	39	31	31		6	2	<b>74,52</b>
<b>643868</b>	F4	50x4,5	32x3	50x4,5	65	40	34	34		6	2	<b>88,45</b>
<b>643878</b>	F4	50x4,5	40x4	50x4,5	79	41	35	35		6	2	<b>100,47</b>
<b>643969</b>	F4	63x6	32x3	63x6	71	46	35	35		2	2	<b>230,96</b>
<b>643979</b>	F4	63x6	40x4	63x6	84	46	35	35		2	2	<b>237,08</b>
<b>R 643161</b>	F4	75x7,5	32x3	75x7,5	71	46	32	32		2	2	<b>281,41</b>
<b>R 643171</b>	F4	75x7,5	40x4	75x7,5	87	48	33	33		2	2	<b>281,41</b>
<b>R 643181</b>	F4	75x7,5	50x4,5	75x7,5	88	49	37	37		2	2	<b>285,88</b>

R Contattare il Customer Service per tempistiche sulla disponibilità



**T filettati femmina Tigris K5**

Codice	Classe	Do1 x Spess.	Ds2	Do3 x Spess.	L mm	Z1 mm	Z2 mm	Z3 mm	P0	P1	Scat.	Conf.	Euro pz.
<b>3079816</b>	F4	16x2	1/2"	16x2	88	24		24			30	10	<b>16,83</b>
<b>3079817</b>	F4	20x2,25	1/2"	20x2,25	100	24		24			20	5	<b>20,50</b>
<b>3079818</b>	F4	20x2,25	3/4"	20x2,25	106	24		24			20	5	<b>28,85</b>
<b>3079820</b>	F4	25x2,5	3/4"	25x2,5	114	27		27			15	5	<b>38,04</b>

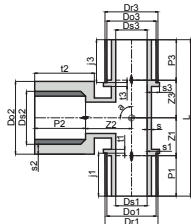

**Bocchettoni filettati femmina**



Codice	Classe	Ø	L mm	L1 mm	L2 mm	Z mm	Z1 mm	Z2 mm	Scat.	Conf.	Euro pz.
<b>R 644230</b>	F4	16 X 3/4"	47	21		14			100	10	<b>21,47</b>
<b>644650</b>	F4	32 x 1" 1/4	64	35		17			25	5	<b>61,07</b>
<b>644760</b>	F4	40 x 1" 1/2	74	45		18			15	3	<b>69,64</b>

**Terminali filettati femmina con staffa Tigris K5**



Codice	Classe	Do1 x Spess.	Ds2	L mm	Z mm	Z1 mm	Z2 mm	Z3 mm	P0 mm	P1	Scat.	Conf.	Euro pz.
<b>3079854</b>	F4	16x2	1/2"	50		24	11				20	10	<b>16,65</b>
<b>3079855</b>	F4	20x2,25	1/2"	50		24	11				20	10	<b>17,74</b>

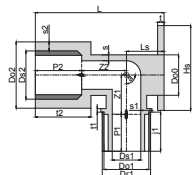

R Contattare il Customer Service per tempistiche sulla disponibilità



**Terminali filettati femmina doppi con staffa Tigris K5**

Codice	Classe	Do1 x Spess.	Do3	Do2 x Spess.	Z mm	Z1 mm	Z2 mm	Z3 mm	P0 mm	P1 mm	Scat.	Conf.	Euro pz.
<b>3079857</b>	F4	16x2	1/2"	16x2		27	12	27			20	10	<b>26,95</b>
<b>3079858</b>	F4	20x2,25	1/2"	20x2,25		27	12	27			20	10	<b>31,67</b>



**Tappo a pressare**

Codice	Classe	De	Scat.	Conf.	Euro pz.
<b>3079859</b>	F4	16	60	10	<b>6,58</b>



**Tappi prova impianto**

Codice	Classe	Descrizione	Conf.	Euro pz.
<b>609945</b>	X4	Rosso 1/2"	100	<b>1,32</b>
<b>609946</b>	X4	Blu 1/2"	100	<b>1,32</b>
<b>609947</b>	X4	Rosso 3/4"	100	<b>3,54</b>
<b>609948</b>	X4	Blu 3/4"	100	<b>3,54</b>



**Dima speciale angolata multipla**



Codice	Classe	L mm	L1 mm	L2 mm	L3 mm	B mm	S mm	a mm	a1 mm	Conf.	Euro pz.
<b>649907</b>	F4	423	253	85	50	50	2	76,5	153	10	<b>26,11</b>

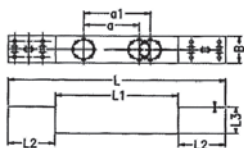



**Collettori uso sanitario e riscaldamento**

Codice	Classe	Mod.	L mm	L1 mm	L2 mm	Z mm	Z1 mm	a mm	Scat.	Conf.	Euro pz.
<b>649802</b>	F4	2 vie	133	39		112	26	55	10	2	<b>22,54</b>
<b>649803</b>	F4	3 vie	188	39		167	26	55	10	2	<b>26,46</b>

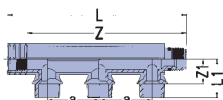

**Ingressi filettati femmina per collettore**

Codice	Classe	Desc.	L mm	L1 mm	L2 mm	Z mm	Z1 mm	a mm	Scat.	Conf.	Euro pz.
<b>R 649823</b>	F4	3/4"	45			29			50	10	<b>16,81</b>

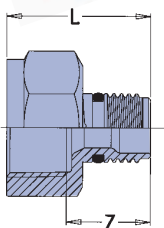

**Adattatore a pressare per ingresso collettore**

Codice	Classe	Ø	L mm	L1 mm	L2 mm	Z mm	Z1 mm	a mm	Scat.	Conf.	Euro pz.
<b>3079808</b>	F4	25	67				51		40	10	<b>15,08</b>



**Ingressi filettati maschio per collettore**

Codice	Classe	Desc.	L mm	L1 mm	L2 mm	Z mm	Z1 mm	a mm	Scat.	Conf.	Euro pz.
<b>R 649833</b>	F4	3/4"	57			34			50	10	<b>14,24</b>

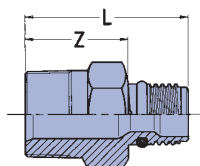

R Contattare il Customer Service per tempistiche sulla disponibilità



**Tappo per collettore**

	Codice	Classe	Desc.	L mm	L1 mm	L2 mm	Z mm	Z1 mm	a mm	Scat.	Conf.	Euro pz.
<b>R</b>	<b>649810</b>	F4	Tappo per collettore	28			7			50	10	<b>5,90</b>

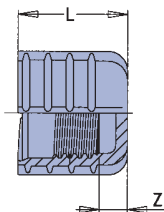

**Tappo per uscite collettore**

	Codice	Classe	Desc.	L mm	L1 mm	L2 mm	Z mm	Z1 mm	a mm	Scat.	Conf.	Euro pz.
	<b>649811</b>	F4	Tappo per uscite collettore	18			9			50	10	<b>24,77</b>

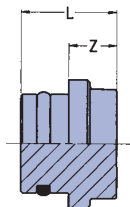

**Adattatori a pressione per uscite collettore**

	Codice	Classe	Desc.	L mm	L1 mm	L2 mm	Z mm	Z1 mm	a mm	Scat.	Conf.	Euro pz.
	<b>3079809</b>	F4	16	57	21					50	10	<b>8,72</b>
	<b>3079810</b>	F4	20	65	27					50	10	<b>10,09</b>

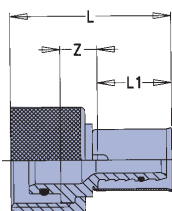

R Contattare il Customer Service per tempistiche sulla disponibilità



# Profili

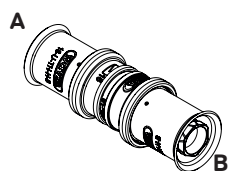

## Manicotti Tigris K5

Codice	A Ø x Spess.	A Profilo	B Ø x Spess.	B Profilo
<b>3079754</b>	16x2	U-H-TH-B-UP	16x2	U-H-TH-B-UP
<b>3079755</b>	20x2,25	U-H-TH-B-UP	20x2,25	U-H-TH-B-UP
<b>3079756</b>	25x2,5	U-H-TH-UP	25x2,5	U-H-TH-UP
<b>3079757</b>	32x3	U-H-TH-B-UP	32x3	U-H-TH-B-UP
<b>3079758</b>	40x4	U-TH-UP	40x4	U-TH-UP

## Manicotti Tigris K1

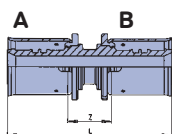

Codice	A Ø x Spess.	A Profilo	B Ø x Spess.	B Profilo
<b>645008</b>	50x4,5	U	50x4,5	U
<b>645009</b>	63x6	U	63x6	U
<b>645010</b>	75x7,5	U	75x7,5	U

## Manicotti ridotti Tigris K5

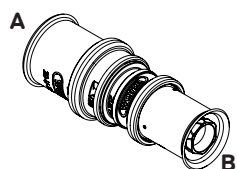

Codice	A Ø x Spess.	A Profilo	B Ø x Spess.	B Profilo
<b>3079759</b>	20x2,25	U-H-TH-B-UP	16x2	U-H-TH-B-UP
<b>3079760</b>	25x2,5	U-H-TH-UP	16x2	U-H-TH-B-UP
<b>3079761</b>	25x2,5	U-H-TH-UP	20x2,25	U-H-TH-B-UP
<b>3079762</b>	32x3	U-H-TH-B-UP	20x2,25	U-H-TH-B-UP
<b>3079763</b>	32x3	U-H-TH-B-UP	25x2,5	U-H-TH-UP
<b>3079764</b>	40x4	U-TH-UP	32x3	U-H-TH-B-UP

## Manicotti ridotti Tigris K1

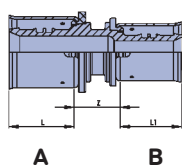

Codice	A Ø x Spess.	A Profilo	B Ø x Spess.	B Profilo
<b>645086</b>	50x4,5	U	32x3	U
<b>645087</b>	50x4,5	U	40x4	U
<b>645097</b>	63x6	U	40x4	U
<b>645098</b>	63x6	U	50x4,5	U
<b>645108</b>	75x7,5	U	50x4,5	U
<b>645109</b>	75x7,5	U	63x6	U

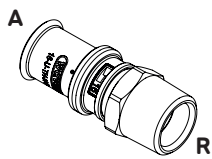

**Manicotti filettati maschio Tigris K5**

Codice	A Ø x Spess.	A Profilo	R
<b>3079798</b>	16x2	U-H-TH-B-UP	1/2"
<b>3079800</b>	20x2,25	U-H-TH-B-UP	1/2"
<b>3079801</b>	20x2,25	U-H-TH-B-UP	3/4"
<b>3079802</b>	25x2,5	U-H-TH-UP	3/4"
<b>3079803</b>	25x2,5	U-H-TH-UP	1"
<b>3079804</b>	32x3	U-H-TH-B-UP	1"
<b>3079806</b>	40x4	U-TH-UP	1"1/4

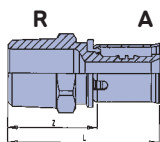

**Manicotti filettati maschio Tigris K1**

Codice	A Ø x Spess.	A Profilo	R
<b>645860</b>	50x4,5	U	1"1/2

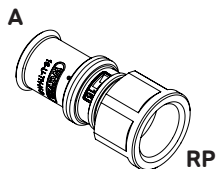

**Manicotti filettati femmina Tigris K5**

Codice	A Ø x Spess.	A Profilo	RP
<b>3079788</b>	16x2	U-H-TH-B-UP	1/2"
<b>3079790</b>	20x2,25	U-H-TH-B-UP	1/2"
<b>3079791</b>	20x2,25	U-H-TH-B-UP	3/4"
<b>3079793</b>	25x2,5	U-H-TH-UP	3/4"
<b>3079796</b>	32x3	U-H-TH-B-UP	1"
<b>3079797</b>	40x4	U-TH-UP	1"1/4

**Gomiti 45° Tigris K5**

Codice	A Ø x Spess.	A Profilo	B Ø x Spess.	B Profilo
<b>3079773</b>	25x2,5	U-H-TH-UP	25x2,5	U-H-TH-UP
<b>3079774</b>	32x3	U-H-TH-B-UP	32x3	U-H-TH-B-UP
<b>3079775</b>	40x4	U-TH-UP	40x4	U-TH-UP

**Gomiti 45° Tigris K1**

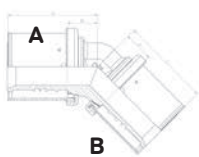

Codice	A Ø x Spess.	A Profilo	B Ø x Spess.	B Profilo
<b>641508</b>	50x4,5	U	50x4,5	U
<b>641509</b>	63x6	U	63x6	U
<b>641510</b>	75x7,5	U	75x7,5	U

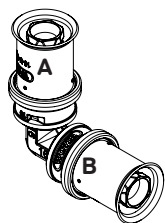

**Gomiti 90° Tigris K5**

Codice	A Ø x Spess.	A Profilo	B Ø x Spess.	B Profilo
<b>3079768</b>	16x2	U-H-TH-B-UP	16x2	U-H-TH-B-UP
<b>3079769</b>	20x2,25	U-H-TH-B-UP	20x2,25	U-H-TH-B-UP
<b>3079770</b>	25x2,5	U-H-TH-UP	25x2,5	U-H-TH-UP
<b>3079771</b>	32x3	U-H-TH-B-UP	32x3	U-H-TH-B-UP
<b>3079772</b>	40x4	U-TH-UP	40x4	U-TH-UP



**Gomiti 90° Tigris K1**

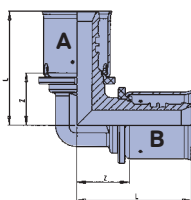

Codice	A Ø x Spess.	A Profilo	B Ø x Spess.	B Profilo
<b>641008</b>	50x4,5	U	50x4,5	U
<b>641009</b>	63x6	U	63x6	U
<b>641010</b>	75x7,5	U	75x7,5	U

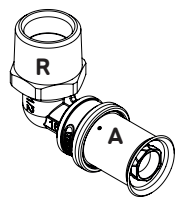

**Gomiti filettati maschio Tigris K5**

Codice	A Ø x Spess.	A Profilo	R
<b>3079776</b>	16x2	U-H-TH-B-UP	1/2"
<b>3079777</b>	20x2,25	U-H-TH-B-UP	1/2"
<b>3079778</b>	20x2,25	U-H-TH-B-UP	3/4"
<b>3079779</b>	25x2,5	U-H-TH-UP	3/4"
<b>3079781</b>	32x3	U-H-TH-B-UP	1"

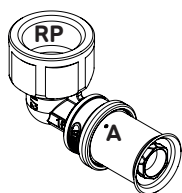

**Gomiti filettati femmina Tigris K5**

Codice	A Ø x Spess.	A Profilo	RP
<b>3079782</b>	16x2	U-H-TH-B-UP	1/2"
<b>3079783</b>	20x2,25	U-H-TH-B-UP	1/2"
<b>3079784</b>	20x2,25	U-H-TH-B-UP	3/4"
<b>3079785</b>	25x2,5	U-H-TH-UP	3/4"
<b>3079786</b>	32x3	U-H-TH-B-UP	1"

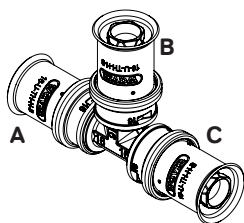

**T semplici Tigris K5**

Codice	A Ø x Spess.	A Profilo	B Ø x Spess.	B Profilo	C Ø x Spess.	C Profilo
<b>3079811</b>	16x2	U-H-TH-B-UP	16x2	U-H-TH-B-UP	16x2	U-H-TH-B-UP
<b>3079812</b>	20x2,25	U-H-TH-B-UP	20x2,25	U-H-TH-B-UP	20x2,25	U-H-TH-B-UP
<b>3079813</b>	25x2,5	U-H-TH-UP	25x2,5	U-H-TH-UP	25x2,5	U-H-TH-UP
<b>3079814</b>	32x3	U-H-TH-B-UP	32x3	U-H-TH-B-UP	32x3	U-H-TH-B-UP
<b>3079815</b>	40x4	U-TH-UP	40x4	U-TH-UP	40x4	U-TH-UP

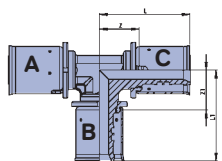

**T semplici Tigris K1**

Codice	A Ø x Spess.	A Profilo	B Ø x Spess.	B Profilo	C Ø x Spess.	C Profilo
<b>643008</b>	50x4,5	U	50x4,5	U	50x4,5	U
<b>643009</b>	63x6	U	63x6	U	63x6	U
<b>643010</b>	75x7,5	U	75x7,5	U	75x7,5	U

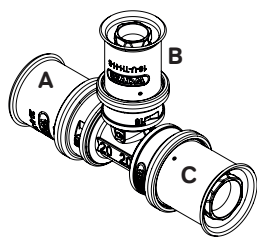

**T ridotti Tigris K5**

Codice	A Ø x Spess.	A Profilo	B Ø x Spess.	B Profilo	C Ø x Spess.	C Profilo
<b>3079821</b>	16x2	U-H-TH-B-UP	20x2,5	U-H-TH-B-UP	16x2	U-H-TH-B-UP
<b>3079822</b>	20x2,25	U-H-TH-B-UP	16x2	U-H-TH-B-UP	16x2	U-H-TH-B-UP
<b>3079823</b>	20x2,25	U-H-TH-B-UP	16x2	U-H-TH-B-UP	20x2,25	U-H-TH-B-UP
<b>3079824</b>	20x2,25	U-H-TH-B-UP	20x2,25	U-H-TH-B-UP	16x2	U-H-TH-B-UP
<b>3079825</b>	25x2,5	U-H-TH-UP	20x2,25	U-H-TH-B-UP	20x2,25	U-H-TH-B-UP
<b>3079826</b>	20x2,25	U-H-TH-B-UP	25x2,5	U-H-TH-UP	20x2,25	U-H-TH-B-UP
<b>3079829</b>	25x2,5	U-H-TH-UP	16x2	U-H-TH-B-UP	16x2	U-H-TH-B-UP
<b>3079827</b>	25x2,5	U-H-TH-UP	16x2	U-H-TH-B-UP	25x2,5	U-H-TH-UP
<b>3079828</b>	25x2,5	U-H-TH-UP	20x2,25	U-H-TH-B-UP	25x2,5	U-H-TH-UP
<b>3079833</b>	25x2,5	U-H-TH-UP	32x3	U-H-TH-B-UP	25x2,5	U-H-TH-UP
<b>3079834</b>	32x3	U-H-TH-B-UP	16x2	U-H-TH-B-UP	32x3	U-H-TH-B-UP
<b>3079835</b>	32x3	U-H-TH-B-UP	20x2,25	U-H-TH-B-UP	32x3	U-H-TH-B-UP
<b>3079836</b>	32x3	U-H-TH-B-UP	25x2,5	U-H-TH-UP	25x2,5	U-H-TH-UP
<b>3079837</b>	32x3	U-H-TH-B-UP	25x2,5	U-H-TH-UP	32x3	U-H-TH-B-UP
<b>3079839</b>	40x4	U-TH-UP	25x2,5	U-H-TH-UP	40x4	U-TH-UP
<b>3079841</b>	40x4	U-TH-UP	25x2,5	U-H-TH-UP	32x3	U-H-TH-B-UP
<b>3079840</b>	40x4	U-TH-UP	32x3	U-H-TH-B-UP	40x4	U-TH-UP
<b>3079842</b>	40x4	U-TH-UP	32x3	U-H-TH-B-UP	32x3	U-H-TH-B-UP

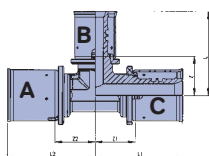

**T ridotti Tigris K1**

Codice	A Ø x Spess.	A Profilo	B Ø x Spess.	B Profilo	C Ø x Spess.	C Profilo
<b>643858</b>	50x4,5	U	25x2,5	U	50x4,5	U
<b>643868</b>	50x4,5	U	32x3	U	50x4,5	U
<b>643878</b>	50x4,5	U	40x4	U	50x4,5	U
<b>643858</b>	63x6	U	25x2,5	U	50x4,5	U
<b>643868</b>	63x6	U	32x3	U	63x6	U
<b>643979</b>	63x6	U	40x4	U	63x6	U
<b>643161</b>	75x7,5	U	32x3	U	75x7,5	U
<b>643171</b>	75x7,5	U	40x4	U	75x7,5	U
<b>643181</b>	75x7,5	U	50x4,5	U	75x7,5	U

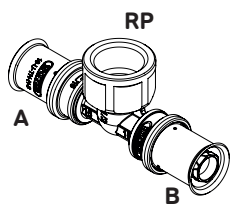

### T filettati femmina Tigris K5

Codice	A Ø x Spess.	A Profilo	RP	B Ø x Spess.	C Profilo
<b>3079816</b>	16x2	U-H-TH-B-UP	1/2"	16x2	U-H-TH-B-UP
<b>3079817</b>	20x2,25	U-H-TH-B-UP	1/2"	20x2,25	U-H-TH-B-UP
<b>3079818</b>	20x2,25	U-H-TH-B-UP	3/4"	20x2,25	U-H-TH-B-UP
<b>3079820</b>	25x2,5	U-H-TH-UP	3/4"	25x2,5	U-H-TH-UP

### Bocchettoni Tigris K1

Codice	A Ø x Spess.	A Profilo	RP
<b>644230</b>	16x2	U	3/4"
<b>644430</b>	20x2,25	U	3/4"
<b>644540</b>	25x2,5	U	1"
<b>644650</b>	32x3	U	1 1/4"
<b>644760</b>	40x4	U	1 1/2"



**MULTI  
JAW**

**Terminali filettati femmina doppi con staffa Tigris K5**

Codice	A Ø x Spess.	A Profilo	RP	B Ø x Spess.	B Profilo
<b>3079857</b>	16x2	U-H-TH-B-UP	1/2"	16x2	U-H-TH-B-UP
<b>3079858</b>	20x2,25	U-H-TH-B-UP	1/2"	20x2,25	U-H-TH-B-UP

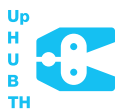
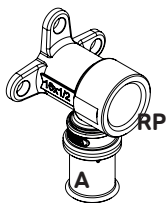

**MULTI  
JAW**

**Terminali filettato femmina con staffa Tigris K5**

Codice	A Ø x Spess.	A Profilo	RP
<b>3079854</b>	16x2	U-H-TH-B-UP	1/2"
<b>3079855</b>	20x2,25	U-H-TH-B-UP	1/2"





# WAVIN smartFIX



smartFIX



**Manicotti**

Codice	Classe	Ø	L mm	L1 mm	L2 mm	Z mm	Z1 mm	Z2 mm	Scat.	Conf.	Euro pz.
<b>PPSU</b>											
R 745002	F7	16	63			21			70	10	<b>9,86</b>
R 745004	F7	20	74			23			50	10	<b>12,79</b>
R 745005	F7	25	88			26			30	5	<b>19,92</b>

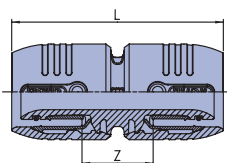

**Manicotti ridotti**

Codice	Classe	Ø	L mm	L1 mm	L2 mm	Z mm	Z1 mm	Z2 mm	Scat.	Conf.	Euro pz.
<b>PPSU</b>											
745042	F7	20 x 16		26	21	29			50	10	<b>13,30</b>

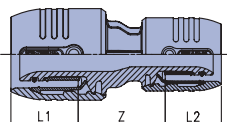

R Contattare il Customer Service per tempistiche sulla disponibilità



**Manicotti filettati maschio**

Codice	Classe	Ø	L mm	L1 mm	L2 mm	Z mm	Z1 mm	Z2 mm	Scat.	Conf.	Euro pz.
--------	--------	---	---------	----------	----------	---------	----------	----------	-------	-------	-------------

**PPSU**

R <b>745220</b>	F7	16 x 1/2"	60			39			70	10	<b>8,62</b>
-----------------	----	-----------	----	--	--	----	--	--	----	----	-------------

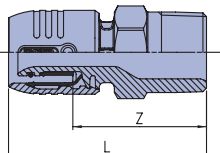

Codice	Classe	Ø	L mm	L1 mm	L2 mm	Z mm	Z1 mm	Z2 mm	Scat.	Conf.	Euro pz.
--------	--------	---	---------	----------	----------	---------	----------	----------	-------	-------	-------------

**Ottone**

<b>747220</b>	F7	16 x 1/2"	60			39			20	5	<b>18,16</b>
R <b>747420</b>	F7	20 x 1/2"	66			40			20	5	<b>21,44</b>
R <b>747430</b>	F7	20 x 3/4"	71			45			10	2	<b>26,60</b>
R <b>747530</b>	F7	25 x 3/4"	78			47			10	2	<b>27,71</b>

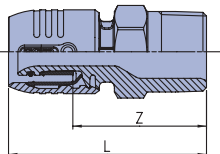

**Manicotti filettati femmina**



Codice	Classe	Ø	L mm	L1 mm	L2 mm	Z mm	Z1 mm	Z2 mm	Scat.	Conf.	Euro pz.
--------	--------	---	---------	----------	----------	---------	----------	----------	-------	-------	-------------

**Ottone**

<b>747202</b>	F7	16 x 1/2"	56	21		20			20	5	<b>21,64</b>
R <b>747304</b>	F7	20 x 3/4"	62	26		21			10	2	<b>37,19</b>
R <b>747305</b>	F7	25 x 3/4"	84	31		21			10	2	<b>42,63</b>

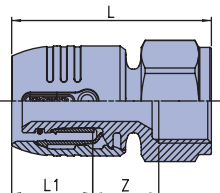

R Contattare il Customer Service per tempistiche sulla disponibilità



**Gomiti 90°**

Codice	Classe	Ø	L mm	L1 mm	L2 mm	Z mm	Z1 mm	Z2 mm	Scat.	Conf.	Euro pz.
<b>PPSU</b>											
<b>741002</b>	F7	16	42			21			70	10	<b>13,35</b>
<b>R 741004</b>	F7	20	50			24			50	10	<b>17,91</b>
<b>R 741005</b>	F7	25	59			28			15	5	<b>27,16</b>

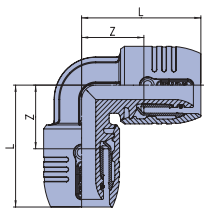

**Gomiti 90° filettati maschio**

Codice	Classe	Ø	L mm	L1 mm	L2 mm	Z mm	Z1 mm	Z2 mm	Scat.	Conf.	Euro pz.
<b>PPSU</b>											
<b>R 741220</b>	F7	16 x 1/2"	43		40	22			70	10	<b>12,11</b>

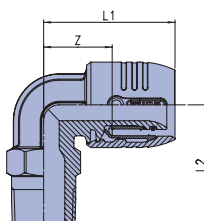

Codice	Classe	Ø	L mm	L1 mm	L2 mm	Z mm	Z1 mm	Z2 mm	Scat.	Conf.	Euro pz.
<b>Ottone</b>											
<b>R 746220</b>	F7	16 x 1/2"		43	40	22			30	5	<b>36,18</b>

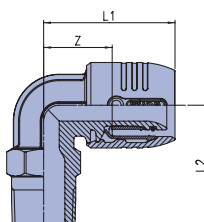

R Contattare il Customer Service per tempistiche sulla disponibilità

**Gomiti 90° filettati femmina**



Codice	Classe	Ø	L mm	L1 mm	L2 mm	Z mm	Z1 mm	Z2 mm	Scat.	Conf.	Euro pz.
<b>PPSU</b>											
<b>741202</b>	F7	16 x 1/2"		43	36		22	20	70	10	<b>13,10</b>
<b>R 741204</b>	F7	20 x 1/2"		50	38		24	22	50	5	<b>16,32</b>

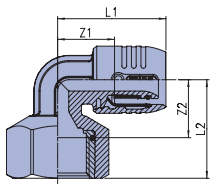

**T semplici**



Codice	Classe	Ø	L1 mm	L2 mm	L3 mm	Z1 mm	Z2 mm	Z3 mm	Scat.	Conf.	Euro pz.
<b>PPSU</b>											
<b>743002</b>	F7	16	41		41	21		21	50	10	<b>15,25</b>

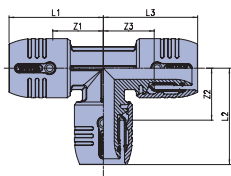

**T ridotti**



Codice	Classe	Ø	L1 mm	L2 mm	L3 mm	Z1 mm	Z2 mm	Z3 mm	Scat.	Conf.	Euro pz.
<b>743422</b>	F7	20x16x16	48	44	42	22	20	21	40	10	<b>24,69</b>
<b>743424</b>	F7	20x16x20	48	47	48	22	20	22	40	10	<b>25,07</b>

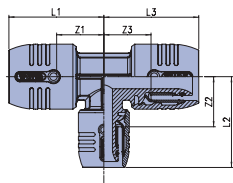

R Contattare il Customer Service per tempistiche sulla disponibilità



**T filettati femmina**

Codice	Classe	Ø	L1 mm	L2 mm	L3 mm	Z1 mm	Z2 mm	Z3 mm	Scat.	Conf.	Euro pz.
--------	--------	---	----------	----------	----------	----------	----------	----------	-------	-------	-------------

**PPSU**

<b>R 743202</b>	F7	16x1/2"x16	42	36	42	21	20	21	30	5	<b>23,46</b>
-----------------	----	------------	----	----	----	----	----	----	----	---	--------------

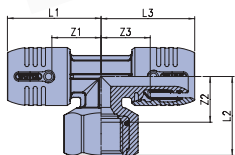

**Terminali con staffa**

Codice	Classe	Ø	L1 mm	L2 mm	L3 mm	Z1 mm	Z2 mm	Z3 mm	Scat.	Conf.	Euro pz.
--------	--------	---	----------	----------	----------	----------	----------	----------	-------	-------	-------------

**PPSU**

<b>R 748202</b>	F7	16 x 1/2"	33	50	18	12	30		30	5	<b>18,92</b>
-----------------	----	-----------	----	----	----	----	----	--	----	---	--------------

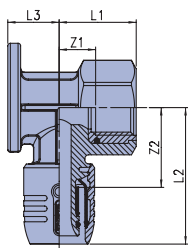

**Tappi prova impianto**

Codice	Classe	Descrizione	Conf.	Euro pz.
--------	--------	-------------	-------	-------------

<b>609945</b>	X4	Rosso 1/2"	100	<b>1,32</b>
<b>609946</b>	X4	Blu 1/2"	100	<b>1,32</b>
<b>609947</b>	X4	Rosso 3/4"	100	<b>3,54</b>
<b>609948</b>	X4	Blu 3/4"	100	<b>3,54</b>

**Dima speciale angolata multipla**



Codice	Classe	L mm	L1 mm	L2 mm	L3 mm	B mm	S mm	a mm	a1 mm	Scat.	Conf.	Euro pz.
--------	--------	---------	----------	----------	----------	---------	---------	---------	----------	-------	-------	-------------

<b>649907</b>	F4	423	253	85	50	50	2	76,5	153	10	10	<b>26,11</b>
---------------	----	-----	-----	----	----	----	---	------	-----	----	----	--------------

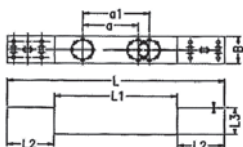

R Contattare il Customer Service per tempistiche sulla disponibilità

## Attrezzature MP



### Pressatrice a batteria "Mini" ACO103 BT

Codice	Classe	Descrizione	Conf.	Euro pz.
<b>360640</b>	X4	Pressatrice a batteria Mini ACO103 BT	1	<b>4.557,32</b>

#### DATI TECNICI

Range: Ø 16-40\* (\*tubi multistrato)

Peso: 1,7 kg

Alimentazione: 12 V/1,5 Ah Li-Ion

Numero pressate: 40-180

Tempo di carica batteria: ca 30-60 min.

Assorbimento: 240W

Forza: 19 Km

Corsa: 30mm

Tecnologia Bluetooth per trasferimento dati e controllo prestazioni con l'applicazione "NovoCheck"



### Ganascie per "Mini" ACO con profilo U

<b>360622</b>	X4	Ganascia ACO Mini Ø 16	1	<b>399,22</b>
<b>360624</b>	X4	Ganascia ACO Mini Ø 20	1	<b>363,07</b>
<b>360625</b>	X4	Ganascia ACO Mini Ø 25	1	<b>457,86</b>
<b>360628</b>	X4	Ganascia ACO Mini Ø 26	1	<b>527,80</b>
<b>360626</b>	X4	Ganascia ACO Mini Ø 32	1	<b>406,58</b>
<b>R 360627</b>	X4	Ganascia ACO Mini Ø 40	1	<b>631,95</b>



### Pressatrice elettrica 230V ECO203

Codice	Classe	Descrizione	Conf.	Euro pz.
<b>360695</b>	X4	Pressatrice Elettrica 230V ECO203	1	<b>4.065,77</b>

#### DATI TECNICI

Peso: 3,2 kg

Alimentazione: 230 V

Range: dal Ø16 al Ø75

Durata di pressata: 4-6 sec.

Assorbimento: 450W

Forza: 32Km

Corsa: 40mm

**R** Contattare il Customer Service per tempistiche sulla disponibilità



**Pressatrice a batteria 18V ACO203 BT**

Codice	Classe	Descrizione	Conf.	Euro pz.
<b>360650</b>	X4	Pressatrice batteria 18V ACO203 BT	1	<b>6.969,37</b>

**DATI TECNICI**

Peso: 2,8 kg  
 Alimentazione: 18 V/1,5 Ah-Li-Ion  
 Range: dal Ø16 al Ø75  
 Durata di pressata: 5-7 sec.

Assorbimento: 400W  
 Forza: 32Km  
 Corsa: 40mm  
 Numero pressate: 55-110  
 Tempo di ricarica: 30-60 min.  
 Tecnologia Bluetooth per trasferimento dati e controllo prestazioni con l'applicazione "NovoCheck"

**COMUNICAZIONE TECNICA**

Attenzione:

la connessione tubo e raccordo viene garantita quando vengono utilizzate attrezzature Wavin (pressatrici e ganasce) o pressatrici compatibili con ganasce Wavin.

Per la garanzia delle connessioni con attrezzature diverse, Vi preghiamo di rivolgervi direttamente al produttore di queste ultime.



Ganascia Ø 16 ÷ Ø 50

**Ganasce per pressatrici elettriche con profilo U**

Codice	Classe	Ø	Descrizione	Conf.	Euro pz.
<b>360672</b>	X4	16		1	<b>561,70</b>
<b>360674</b>	X4	20		1	<b>617,88</b>
<b>360675</b>	X4	25		1	<b>663,69</b>
<b>360676</b>	X4	32		1	<b>581,44</b>
<b>360677</b>	X4	40		1	<b>821,20</b>
<b>360678</b>	X4	50		1	<b>821,20</b>
<b>360499</b>	X4	63		1	<b>1174,66</b>
<b>360780</b>	X4	75	Ganascia collare	1	<b>1016,51</b>
<b>360781</b>	X4	75	Adattatore ganascia collare	1	<b>1086,21</b>

Ganascia Ø 63

Per l'utilizzo su pressatrici in commercio contattare il produttore dell'utensile



Adattatore ganascia collare Ø 75  
 cod. 360 781



Ganascia collare Ø 75  
 cod. 360 780



**Ganasce per pressatrici elettriche con profilo TH**

Codice	Classe	Descrizione	Conf.	Euro pz.
<b>360079</b>	X4	Ø 26	1	<b>493,95</b>



**STAR Calibratore 16/20/25**

Codice	Classe	Descrizione	Conf.	Euro pz.
<b>361510</b>	X4	STAR Calibratore 16/20/25	1	<b>152,76</b>

**Set calibratore Kalispeed**

Codice	Classe	Descrizione	Conf.	Euro pz.
<b>361490</b>	X4	Ø 16/20/25/32	1	<b>407,18</b>

**Impugnatura per Kalispeed 16-32**

Codice	Classe	Descrizione	Conf.	Euro pz.
<b>361499</b>	X4	Impugnatura per Kalispeed	1	<b>68,20</b>

**Impugnatura click-grip Kalispeed 16-75**

Codice	Classe	Descrizione	Conf.	Euro pz.
<b>361450</b>	X4	Impugnatura per click-grip per Kalispeed 16-75	1	<b>92,56</b>

**Calibratore per Kalispeed 14-32**

Codice	Classe	Descrizione	Conf.	Euro pz.
<b>361492</b>	X4	Calibratore per Kalispeed 16	1	<b>81,03</b>
<b>361497</b>	X4	Calibratore per Kalispeed 20(2.0)	1	<b>87,87</b>
<b>361494</b>	X4	Calibratore per Kalispeed 20	1	<b>87,87</b>
<b>361495</b>	X4	Calibratore per Kalispeed 25	1	<b>92,87</b>
<b>361498</b>	X4	Calibratore per Kalispeed 26	1	<b>94,16</b>
<b>361496</b>	X4	Calibratore per Kalispeed 32	1	<b>97,92</b>



**Calibratore per Kalispeed 40-75**

Codice	Classe	Descrizione	Conf.	Euro pz.
<b>361457</b>	X4	Calibratore per kalispeed 40	1	<b>146,86</b>
<b>361458</b>	X4	Calibratore per kalispeed 50	1	<b>166,74</b>
<b>361459</b>	X4	Calibratore per kalispeed 63	1	<b>279,75</b>
<b>R 361460</b>	X4	Calibratore per kalispeed 75	1	<b>290,36</b>



**Cesoia ferma tubo**

Codice	Classe	Descrizione	Conf.	Euro pz.
<b>R 360424</b>	X4	Cesoie ferma tubo Ø 16/26	1	<b>217,29</b>
<b>R 360426</b>	X4	Lama di ricambio per cesoia con fermatubo	1	<b>29,04</b>



**Tagliatubi**

Codice	Classe	Descrizione	Conf.	Euro pz.
<b>R 360460</b>	X4	Ø 16/75	1	<b>174,26</b>
<b>R 360461</b>	X4	Lama di ricambio	1	<b>21,78</b>



**Molle piegatubi**

Codice	Classe	Descrizione	Conf.	Euro pz.
<b>360442</b>	X4	Ø 16	1	<b>29,04</b>
<b>360444</b>	X4	Ø 20	1	<b>31,96</b>
<b>360445</b>	X4	Ø 25-26	1	<b>36,31</b>

R Contattare il Customer Service per tempistiche sulla disponibilità

## Ricambi

Codice	Classe	Descrizione	Euro pz.
* <b>360454</b>	X4	Carica batteria per pressatrice UAP3L e MAP2L Klauke	<b>550,08</b>
<b>R 360451</b>	X4	Batteria di ricambio per pressatrice elettroidraulica Klauke	<b>509,22</b>
<b>R 360453</b>	X4	Batteria di ricambio per pressatrice elettroidraulica UAP3L Klauke	<b>598,27</b>
<b>R 360511</b>	X4	Batteria di ricambio per pressatrice "Mini" Klauke - RAM2 9,6V 2Ah	<b>407,18</b>
<b>R 360642</b>	X4	Batteria di ricambio 3.0 Ah pressatrice Mini ACO102	<b>493,83</b>
<b>R 360653</b>	X4	Carica batteria 230V/18V pressatrice ACO202-203	<b>526,48</b>
<b>R 360643</b>	X4	Carica batteria Mini ACO102	<b>333,87</b>
<b>R 360512</b>	X4	Ganascia diam. 16 pressatrice "Mini" Klauke	<b>351,18</b>
<b>R 360514</b>	X4	Ganascia diam. 20 pressatrice "Mini" Klauke	<b>351,18</b>
<b>R 360515</b>	X4	Ganascia diam. 25 pressatrice "Mini" Klauke	<b>412,17</b>
<b>R 360516</b>	X4	Ganascia diam. 32 pressatrice "Mini" Klauke	<b>389,27</b>

**R** Contattare il Customer Service per tempistiche sulla disponibilità - \* Ad esaurimento



# Wavin tigris green



## Sistema di adduzione in PP RANDOM TYPE3

Il sistema Wavin Tigris Green in PP-R è principalmente utilizzato per la realizzazione di impianti per la distribuzione sanitaria, acqua calda e fredda. Le tubazioni e i raccordi stampati ad iniezione sono realizzati in polipropilene random Type 3 secondo normativa EN 15874 e DIN 8077. Le giunzioni sono eseguite attraverso polifusione assicurando una omogeneità del sistema plastico.

### Applicazioni

Il sistema Wavin Tigris Green è utilizzato per:

- distribuzione sanitaria;
- per impianti di acqua potabile e liquidi alimentari;
- per qualsiasi opera idraulica nel campo dell'edilizia civile, industriale, pubblica (scuole, ospedali) e impianti sportivi (piscine, palestre);
- grazie all'elevata resistenza chimica, il sistema può inoltre essere utilizzato per impianti di aria compressa;
- impianti di irrigazione di serra e giardini.

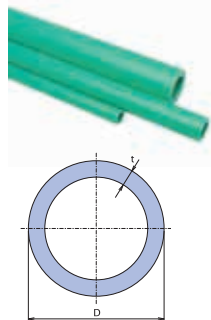

### Tubi in PP-R type 3 S2,5/SDR 6/PN20 in barre da 4 mt

Codice	Classe	Dim. mm	t mm	SDR	Pallet mt.	Conf. mt.	Euro mt.
<b>380004</b>	E1	20	3,4	6	2500	100	<b>3,08</b>
<b>380005</b>	E1	25	4,2	6	1500	60	<b>5,60</b>
<b>380006</b>	E1	32	5,4	6	1000	40	<b>8,50</b>
<b>380007</b>	E1	40	6,7	6	600	24	<b>14,20</b>
<b>380008</b>	E1	50	8,3	6	400	16	<b>20,36</b>
<b>380009</b>	E1	63	10,5	6	240	12	<b>31,83</b>

## Tubazioni in PP-RCT EVO

- Un nuovo standard per la distribuzione dell'acqua
- Tecnologia Innovativa
- Materia prima ad alte prestazioni
- Maggiore durata

Parametri Tecnici	PP-RCT
<b>S (SDR)</b>	S 4 (SDR) Ø 75-110mm
Resistenza a Temperatura/Pressione	20 °C / 50 anni / 19,3 bar
	70°C / 50 anni / 8,5 bar

### Caratteristiche

- **PP-RCT è la nuova generazione del polipropilene (Tipo 4), finora utilizzato solo per i tubi compositi di alta gamma**
- **37% di portata in più se confrontato con i tubi standard in PP-R**
- **28% più leggero = lavoro meno gravoso**
- **PN 22 (valore calcolato)**
- **Maggiore resistenza a pressione e temperature elevate**

### Tempi Saldatura per tubazioni in PP-RCT EVO

D [mm]	75	90	110
Tempo di fusione (s)	30	40	50



### Tubi in PP-RCT EVO S4 SDR9 PN 22 (calcolato) in barre da 4 mt

Codice	Classe	Dim. mm	t mm	SDR	Pallet mt.	Conf. mt.	Euro mt.
* <b>380210</b>	E1	75	8,4	9	200	8	<b>34,39</b>

\* Ad esaurimento

## Sistema con tubazioni composite in PP-RCT per impianti di condizionamento ad acqua refrigerata

Una tubazione speciale a 3 strati rinforzata con fibra di basalto, realizzata in PP-RCT, ossia polipropilene di ultima generazione  
Coefficiente di dilatazione termica lineare estremamente ridotto

### Proprietà delle tubazioni

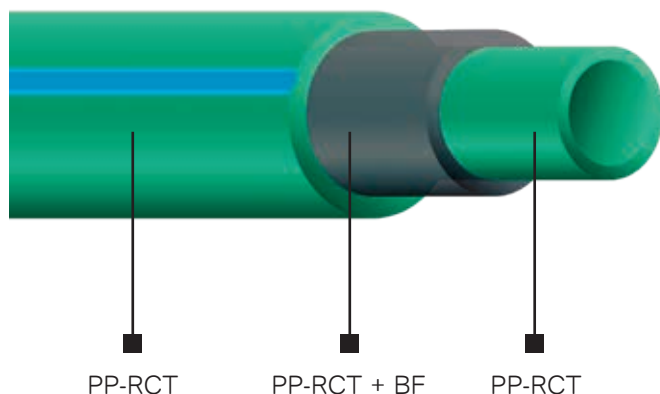

La prima tubazione a 3 strati rinforzata con fibre di basalto

Realizzate con Polipropilene di ultima generazione Type 4 (PP-RCT)

Bassa espansione lineare dovuta alle variazioni di temperatura del fluido grazie al ridotto coefficiente di dilatazione termica.

Alta resistenza a pressione

Peso ridotto fino al **15%**

Dilatazione termica lineare 3 volte più bassa dei tubi standard in PPr

Non occorre raschiare prima della saldatura di tasca (de 20-125mm)

#### **Caratteristiche Gamma 75-250:**

Tubi e raccordi in PP-RCT (type 4)

Le giunzioni si eseguono mediante saldatura Testa/Testa

Tubi e raccordi hanno lo stesso diametro interno

### Specifiche tecniche delle tubazioni

Composizione	PP-RCT / PP-RCT + BF / PP-RCT	
Struttura rinforzata	Fibre di Basalto; densità +8% Resistenza +20%	
Resistenza a pressione e temperatura	d 20, 25 mm	20 °C PN 22 bar (Calcolato) / 50 anni
	d 32 – 250 mm	20 °C PN 18 bar (Calcolato) / 50 anni
S (SDR)	S 4, SDR 9 (d 20, 25 mm) PN 22 (Calcolato) S 5, SDR 11 (d 32-250 mm) PN 18 (Calcolato)	
Coefficiente di dilatazione lineare	0,05 mm / m °C	
Raschiatura del tubo prima della saldatura di tasca	NO	

**Campi di applicazione**

- Impianti condizionamento idronici (T 5-50°C)
- Centrali di raffreddamento
- Sistemi di distribuzione fluidi refrigerati
- Sistemi di distribuzione aria compressa
- Sistemi di distribuzione fluidi industriali



**Tubi Fiber Basalt Clima in barre da 4 mt.**  
**De 20-25 S4/SDR 9/PN22 (Calcolato)**  
**De 32-250 S5/SDR 11/PN18 (Calcolato)**

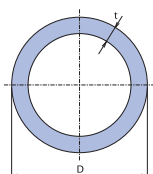

Codice	Classe	Dim. mm	t. mm	SDR	Min. ordine m.	Conf.	Euro mt.
<b>R 370020</b>	E1	20	2,3	9	20.000	100	<b>4,07</b>
<b>370025</b>	E1	25	2,8	9	15.000	60	<b>6,87</b>
<b>370032</b>	E1	32	2,9	11	9.600	40	<b>8,14</b>
<b>370040</b>	E1	40	3,7	11	7.200	24	<b>12,37</b>
<b>370050</b>	E1	50	4,6	11	3.600	16	<b>19,26</b>
<b>370063</b>	E1	63	5,8	11	2.400	12	<b>30,53</b>
<b>370075</b>	E1	75	6,8	11	1.600	8	<b>45,24</b>
<b>370090</b>	E1	90	8,2	11	1.200	4	<b>67,03</b>
<b>370110</b>	E1	110	10,0	11	800	4	<b>101,15</b>
<b>R 370125</b>	E1	125	11,4	11	400	4	<b>145,27</b>
<b>R 370160</b>	E1	160	14,6	11	400	4	<b>326,13</b>
<b>R 370200</b>	E1	200	18,2	11	300	4	<b>548,65</b>
<b>R 370250</b>	E1	250	22,7	11	300	4	<b>852,83</b>

R Contattare il Customer Service per tempistiche sulla disponibilità



## FIBER BASALT PLUS: LA TUBAZIONE DEL FUTURO

Performance delle tubazioni

### FIBER BASALT PLUS

- Maggiore resistenza alla pressione alle temperature elevate fino a **50%**
- Resistenza alla temperatura fino a **90°C**
- Aumento della portata fino al **20%**
- Il tutto mantenendo inalterate le altre caratteristiche della tubazione FIBER:
  - dilatazione termica lineare 3 volte più bassa
  - non è richiesta la raschiatura prima della saldatura



I parametri di FIBER BASALT PLUS	FIBER Basalt Plus Caratteristiche
Composizione	PP-RCT PP-RCT + BF PP-RCT
Rinforzo	Fibra di basalto Densità +8% Resistenza alla trazione +20%
Resistenza alla pressione in base alla Classe 2 (acqua calda a 70°C)*	10 bar
Resistenza alla pressione in base alla Classe 5 (Tmax di riscaldamento: 90°C)*	8 bar
Spessore delle pareti	De 20-63 S 3,2/SDR 7,4/PN28 (Calcolato) De 75-125 S 4/SDR 9/PN22 (Calcolato)
Dilatazione termica lineare (mm/m °C)	0,05
Raschiatura prima della saldatura	No

\* Valore valido per Ø20-63 mm, in conformità a EN ISO 15874

## 1. UTILIZZO DELLE TUBAZIONI FIBER BASALT PLUS

Le tubazioni FIBER presentano tre strati. Lo strato interno e quello esterno sono realizzati in polipropilene di tipo 4 PP-RCT mentre lo strato intermedio è in polipropilene di tipo 4 (PP-RCT) rinforzato con fibra di basalto (BF). La composizione degli strati è la seguente: PP-RCT/PP-RCT+BF/PP-RCT. Le tubazioni FIBER BASALT PLUS sono progettate per il trasporto di acqua calda e fredda, per sistemi di riscaldamento centralizzato, sistemi di raffrescamento, distribuzione sanitaria e aria compressa.

## 2. GAMMA PRODOTTI

Le tubazioni FIBER BASALT PLUS sono disponibili nelle seguenti dimensioni (diametro esterno della tubazione): 20, 25, 32, 40, 50, 63 mm (S 3,2) e 75, 90, 110, 125, (S 4). Le tubazioni FIBER BASALT PLUS sono marcate in base alla serie "S". Il precedente metodo di marcatura delle tubazioni con il codice "PN" non può essere utilizzato per le tubazioni realizzate con i materiali di ultima generazione PP-RCT in quanto i relativi parametri di lavoro (pressione, temperatura, vita utile) superano ampiamente quelle delle tubazioni in PPR. Le tubazioni FIBER BASALT PLUS si saldano ai raccordi del sistema TIGRIS GREEN con le stesse modalità delle tubazioni standard.

## 3. PROPRIETÀ DELLE TUBAZIONI FIBER

### Vantaggi

Grazie alle fibre di basalto, queste tubazioni presentano una dilatazione termica lineare 3 volte inferiore e una maggiore rigidità rispetto alle tubazioni PPR standard.

### Marcatura delle tubazioni FIBER

Le tubazioni sono di colore verde con una banda identificativa marrone. Sulla tubazione è riportata la marcatura contenente le seguenti informazioni: nome del costruttore, la denominazione della tubazione, le dimensioni in base allo spessore delle pareti, la serie, l'ora, la data, il numero della linea:

**wavin** EKOPLASTIK FIBER BASALT PLUS PP-RCT/PP-RCT+BF/PP-RCT, ora, data, n° della linea. Fabbricata nell'Unione europea (Repubblica Ceca)

Norme di fabbricazione e collaudo prodotti

Le tubazioni FIBER BASALT PLUS sono realizzate in conformità ai requisiti della norma EN ISO 15874.



**Tubi Fiber Basalt Plus in barre da 4mt.**  
**De 20-63 S 3,2/SDR 7,4/PN28 (Calcolato)**  
**De 75-125 S 4/SDR 9/PN22 (Calcolato)**

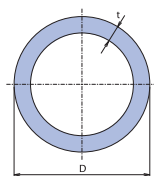

Codice	Classe	Dim. mm	t mm	SDR	Conf. mt.	Euro mt.
<b>380020</b>	E1	20	2,8	7,4	100	<b>5,02</b>
<b>380025</b>	E1	25	3,5	7,4	60	<b>7,82</b>
<b>380032</b>	E1	32	4,4	7,4	40	<b>11,58</b>
<b>380040</b>	E1	40	5,5	7,4	24	<b>19,62</b>
<b>380050</b>	E1	50	6,9	7,4	16	<b>28,26</b>
<b>380063</b>	E1	63	8,6	7,4	12	<b>44,10</b>
<b>380075</b>	E1	75	8,4	9	8	<b>63,41</b>
<b>380090</b>	E1	90	10,1	9	4	<b>96,22</b>
<b>380110</b>	E1	110	12,3	9	4	<b>138,33</b>
<b>R 380125</b>	E1	125	14	9	4	<b>171,78</b>

R Contattare il Customer Service per tempistiche sulla disponibilità

**Gomiti 90°**

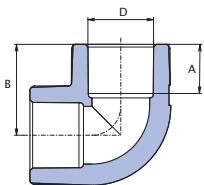

Codice	Classe	Dimensioni mm	A mm	A1 mm	B mm	B1 mm	B2 mm	C mm	Conf.	Euro pz.
<b>381004</b>	E2	20	14,5		26,8				20	<b>1,35</b>
<b>381005</b>	E2	25	16,0		31,0				20	<b>1,63</b>
<b>381006</b>	E2	32	18,0		36,5				10	<b>2,54</b>
<b>381007</b>	E2	40	20,5		43,0				10	<b>7,10</b>
<b>381008</b>	E2	50	23,5		51,0				10	<b>10,83</b>
<b>381009</b>	E2	63	27,5		61,5				5	<b>14,34</b>
<b>387007</b>	E2	75	30,0		70,15				2	<b>23,07</b>
<b>387009</b>	E2	90	33,0		82,0				1	<b>66,55</b>
<b>R 387010</b>	E2	110	37,0		95,0				1	<b>84,34</b>
<b>R 387011</b>	E2	125	40		105,0				1	<b>109,66</b>

**Gomiti 90° PP-RCT S5/SDR 11 Saldatura T/T**

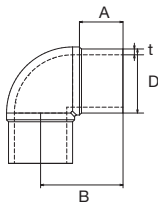

Codice	Classe	Dimensioni mm	A mm	A1 mm	B mm	B1 mm	B2 mm	t mm	Conf.	Euro pz.
<b>R 387012</b>	E2	160	103,0		210,0			14,6	1	<b>218,86</b>
<b>R 387013</b>	E2	200	115,0		239,0			18,2	1	<b>547,01</b>
<b>R 387014</b>	E2	250	116,0		259,0			22,7	1	<b>1094,02</b>

**Gomito 90° maschio/femmina**

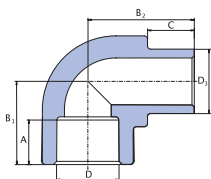

Codice	Classe	Dimensioni mm	D3 mm	A mm	A1 mm	B mm	B1 mm	B2 mm	C mm	Conf.	Euro pz.
<b>381244</b>	E2	20	20	14,5			26,8	30,3	13,0	20	<b>1,63</b>
<b>381245</b>	E2	25	25	16,0			31,0	35,0	14,0	20	<b>1,87</b>
<b>R 381246</b>	E2	32	32	18,0			36,5	42,2	16,0	20	<b>2,54</b>

**R** Contattare il Customer Service per tempistiche sulla disponibilità

**Gomiti 45°**

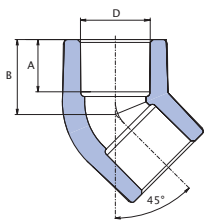

Codice	Classe	Dimensioni mm	A mm	A1 mm	B mm	B1 mm	B2 mm	C mm	Conf.	Euro pz.
<b>381404</b>	E2	20	14,5		20,8				20	<b>1,35</b>
<b>381405</b>	E2	25	16,0		24,0				20	<b>2,25</b>
<b>381406</b>	E2	32	18,0		27,0				20	<b>2,89</b>
<b>381407</b>	E2	40	20,5		31,5				5	<b>7,14</b>
<b>381408</b>	E2	50	23,5		36,5				5	<b>11,28</b>
<b>381409</b>	E2	63	27,5		43,0				5	<b>15,18</b>
<b>387017</b>	E2	75	30,0		48,1				2	<b>23,94</b>
<b>R 387019</b>	E2	90	33,0		54,1				1	<b>45,51</b>
<b>R 387020</b>	E2	110	37		62,10				1	<b>67,40</b>

**Gomiti 45° PP-RCT S5/SDR 11 Saldatura T/T**

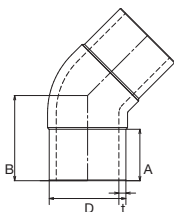

Codice	Classe	Dimensioni mm	A mm	A1 mm	B mm	B1 mm	B2 mm	t mm	Conf.	Euro pz.
<b>R 387021</b>	E2	160	107,0		175,0			14,6	1	<b>218,86</b>
<b>R 387022</b>	E2	200	118,0		190,0			18,2	1	<b>503,34</b>
<b>R 387023</b>	E2	250	130,0		215,0			22,7	1	<b>1013,88</b>

**Gomiti 45° maschio/femmina**

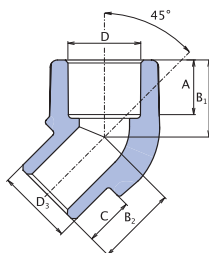

Codice	Classe	Dimensioni mm	D3 mm	A mm	A1 mm	B mm	B1 mm	B2 mm	C mm	Conf.	Euro pz.
<b>R 381445</b>	E2	25	25	16			24	24	14	10	<b>3,13</b>

R Contattare il Customer Service per tempistiche sulla disponibilità



**T semplici**

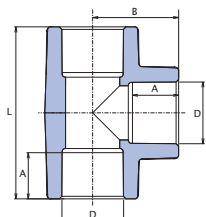

Codice	Classe	Dimensioni mm	A mm	A1 mm	B mm	B1 mm	B2 mm	L mm	Conf.	Euro pz.
<b>383004</b>	E2	20	14,5		27,0			54,0	20	<b>1,55</b>
<b>383005</b>	E2	25	16,0		32,0			60,0	20	<b>2,25</b>
<b>383006</b>	E2	32	18,0		35,7			70,0	20	<b>3,13</b>
<b>383007</b>	E2	40	20,5		38,5			86,2	10	<b>7,14</b>
<b>383008</b>	E2	50	23,5		51,0			102,0	5	<b>12,65</b>
<b>383009</b>	E2	63	27,5		61,5			123,0	5	<b>17,42</b>
<b>387037</b>	E2	75	30,0		70,1			140,2	1	<b>30,69</b>
<b>387039</b>	E2	90	33,0		83,1			166,2	1	<b>70,03</b>
<b>R 387040</b>	E2	110	37,0		99,1			198,2	1	<b>103,29</b>
<b>R 387041</b>	E2	125	40,0		105,0			210,0	1	<b>125,27</b>



**T semplici PP-RCT S5/SDR 11 Saldatura T/T**

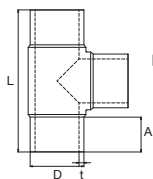

Codice	Classe	Dimensioni mm	A mm	A1 mm	B mm	B1 mm	B2 mm	L mm	t mm	Conf.	Euro pz.
<b>R 387042</b>	E2	160	104,0					423,0	14,6	1	<b>329,67</b>
<b>R 387043</b>	E2	200	117,0					501,0	18,2	1	<b>665,40</b>
<b>R 387044</b>	E2	250	131,0					595,0	22,7	1	<b>1298,74</b>



**T ridotti**

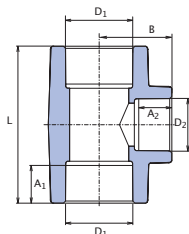

Codice	Classe	Dimensioni mm	A mm	A1 mm	A2 mm	B mm	B2 mm	L mm	Conf.	Euro pz.
<b>383545</b>	E2	25x20x25		16,0	14,5	29,0		55,0	20	<b>2,31</b>
<b>383646</b>	E2	32x20x32		18,0	14,5	34,4		67,0	20	<b>3,43</b>
<b>383656</b>	E2	32x25x32		18,0	16,0	34,4		73,0	20	<b>3,43</b>
<b>383757</b>	E2	40x25x40		20,5	16,0	40,2		66,0	10	<b>9,62</b>
<b>383767</b>	E2	40x32x40		20,5	18,0	41,5		86,0	10	<b>9,41</b>
<b>383868</b>	E2	50x32x50		23,5	18,0	46,0		84,0	5	<b>13,07</b>
<b>383878</b>	E2	50x40x50		23,5	20,5	47,0		91,4	5	<b>21,57</b>
<b>383969</b>	E2	63x32x63		27,5	18,00	52,0		92,0	5	<b>17,98</b>
<b>383979</b>	E2	63x40x63		27,5	20,5	54,6		100,0	5	<b>18,15</b>
<b>R 383989</b>	E2	63x50x63		27,5	23,5	57,2		110,0	5	<b>18,09</b>
<b>R 383990</b>	E2	75x40x75		30	20,5	63,5		115,4	1	<b>21,51</b>
<b>R 384000</b>	E2	75x50x75		30	23,5	63,5		115,4	1	<b>21,63</b>
<b>R 384010</b>	E2	75x63x75		30	27,5	67,5		128,4	1	<b>21,76</b>
<b>R 384011</b>	E2	90x75x90		33	30,0	77,7		146,2	1	<b>33,13</b>

**R** Contattare il Customer Service per tempistiche sulla disponibilità

**T ridotti doppi**

Codice	Classe	Dimensioni mm	A mm	A1 mm	A2 mm	A3 mm	L mm	B mm	Conf.	Euro pz.
R <b>383544</b>	E2	25X20X20		16,0	14,5	14,5	55,2	29,3	10	<b>4,77</b>
R <b>383644</b>	E2	32x20x20		18,0	14,5	14,5	57,3	32,8	10	<b>3,95</b>
R <b>383647</b>	E2	32x25x25		18,0	18,0	16,0	66,0	34,4	10	<b>6,57</b>

**Manicotti**

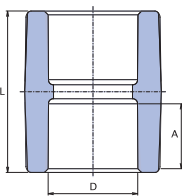

Codice	Classe	Dimensioni mm	A mm	A1 mm	A2 mm	B mm	B2 mm	L mm	Conf.	Euro pz.
<b>384004</b>	E2	20	14,5					34,6	20	<b>1,08</b>
<b>384005</b>	E2	25	16,0					37,8	20	<b>1,32</b>
<b>384006</b>	E2	32	18,0					40,0	20	<b>2,44</b>
<b>384007</b>	E2	40	20,5					48,0	20	<b>4,24</b>
<b>384008</b>	E2	50	23,5					53,0	10	<b>6,78</b>
<b>384009</b>	E2	63	27,5					65,0	5	<b>10,76</b>
<b>387047</b>	E2	75	30,0					73,4	1	<b>20,78</b>
<b>387049</b>	E2	90	33,0					79,2	1	<b>29,49</b>
<b>387050</b>	E2	110	37,0					88,2	1	<b>43,84</b>
R <b>387051</b>	E2	125	40					86,0	1	<b>57,64</b>

**Manicotti elettrici**

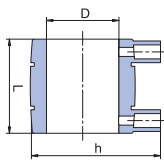

Codice	Classe	Dimensioni mm	t mm	A mm	A1 mm	L mm	H	Conf.	Euro pz.
<b>384204</b>	E2	20				70	52	1	<b>28,16</b>
<b>384205</b>	E2	25				70	57	1	<b>30,50</b>
R <b>384206</b>	E2	32				80	65	1	<b>37,79</b>
R <b>384207</b>	E2	40				90	74	1	<b>50,34</b>
<b>384208</b>	E2	50				100	85	1	<b>55,67</b>
<b>384209</b>	E2	63				110	97	1	<b>63,59</b>
<b>384210</b>	E2	75				120	114	1	<b>81,56</b>
<b>384211</b>	E2	90				130	130	1	<b>102,84</b>
R <b>384212</b>	E2	110				140	152	1	<b>144,01</b>
R <b>384213</b>	E2	125				151	168	1	<b>208,76</b>
R <b>384214</b>	E2	160				176	205	1	<b>249,78</b>
R <b>384215</b>	E2	200				187	245	1	<b>335,22</b>
R <b>384216</b>	E2	250				243	315	1	<b>567,33</b>

R Contattare il Customer Service per tempistiche sulla disponibilità



**Riduzioni maschio femmina**

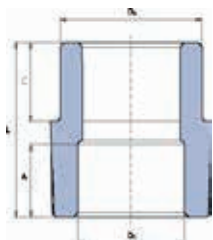

	Codice	Classe	Dimensioni mm	A mm	C mm	L mm	Conf.	Euro pz.
	<b>380554</b>	E2	25x20	14,5	14,0	34,0	20	<b>1,19</b>
	<b>380564</b>	E2	32x20	14,5	16,0	40,0	20	<b>2,44</b>
	<b>380565</b>	E2	32x25	16,0	16,0	39,5	20	<b>1,94</b>
R	<b>380574</b>	E2	40x20	14,5	18,5	47,0	10	<b>3,50</b>
	<b>380575</b>	E2	40x25	16,0	18,5	45,4	10	<b>3,36</b>
	<b>380576</b>	E2	40x32	18,0	18,5	48,2	20	<b>3,59</b>
	<b>380585</b>	E2	50x25	16,0	21,3	41,3	10	<b>8,20</b>
	<b>380586</b>	E2	50x32	18,0	22,0	55,5	10	<b>7,74</b>
	<b>380587</b>	E2	50x40	20,5	22,0	52,0	10	<b>7,58</b>
	<b>380595</b>	E2	63x25	16,0	25,3	49,3	5	<b>13,25</b>
	<b>380596</b>	E2	63x32	18,0	25,3	62,5	5	<b>11,10</b>
	<b>380597</b>	E2	63x40	20,5	25,3	58,5	5	<b>12,42</b>
	<b>380598</b>	E2	63x50	23,5	25,3	58,5	5	<b>12,90</b>
R	<b>387074</b>	E2	75x40	20,5	28,9	64,5	5	<b>21,02</b>
R	<b>387075</b>	E2	75x50	23,5	28,9	64,5	5	<b>21,74</b>
R	<b>387076</b>	E2	75x63	27,5	28,9	71,5	1	<b>24,00</b>
	<b>387077</b>	E2	90x50	23,5	25,5	64,5	1	<b>24,66</b>
R	<b>387096</b>	E2	90x63	27,5	33,4	64,5	1	<b>24,46</b>
R	<b>387097</b>	E2	90x75	30,0	33,4	78,0	1	<b>26,22</b>
	<b>387107</b>	E2	110x75	30,0	39,4	60,0	1	<b>34,99</b>
R	<b>387109</b>	E2	110x90	33,0	39,4	87,0	1	<b>34,99</b>
R	<b>387110</b>	E2	125x110	40,0	42,4	100,3	1	<b>59,08</b>



**Riduzioni PP-RCT S5/SDR 11 Saldatura T/T**

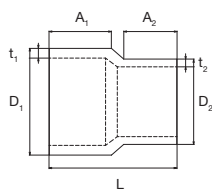

	Codice	Classe	Dimensioni mm	D1 mm	t1 mm	t2 mm	A1 mm	A2 mm	L mm	Conf.	Euro pz.
R	<b>387111</b>	E2	160x110		14,6		106	92	226	1	<b>153,10</b>
R	<b>387112</b>	E2	160x125		14,6		105	93	216	1	<b>153,10</b>
R	<b>387113</b>	E2	200x160		18,2	14,6	117	100	240	1	<b>240,56</b>
R	<b>387114</b>	E2	250x160		22,7	14,6	60	56	162	1	<b>420,17</b>
R	<b>387115</b>	E2	250x200		22,7	18,2	128	116	274	1	<b>484,41</b>

R Contattare il Customer Service per tempistiche sulla disponibilità



**Tappi a calotta**

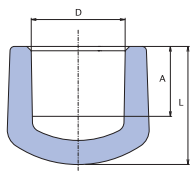

Codice	Classe	Dimensioni mm	A mm	A1 mm	A2 mm	B mm	B2 mm	L mm	Conf.	Euro pz.
<b>384604</b>	E2	20	14,5					24,5	20	<b>1,19</b>
<b>384605</b>	E2	25	16,0					28,0	20	<b>1,40</b>
<b>384606</b>	E2	32	18,0					33,0	20	<b>3,60</b>
<b>384607</b>	E2	40	20,5					39,5	5	<b>7,85</b>
<b>384608</b>	E2	50	23,5					47,0	5	<b>11,07</b>
<b>384609</b>	E2	63	27,5					53,5	5	<b>13,94</b>
<b>R 387057</b>	E2	75	30,0					60,0	5	<b>28,29</b>
<b>R 384610</b>	E2	90	33,0					69,0	1	<b>36,47</b>
<b>R 384611</b>	E2	110	37,0					79,0	1	<b>55,73</b>
<b>R 384612</b>	E2	125	40,0					79,5	1	<b>56,12</b>



**Curve per sorpasso raggio corto**

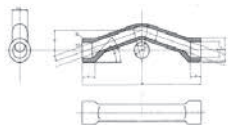

Codice	Classe	Dimensioni mm	A mm	A1 mm	A2 mm	B mm	B2 mm	H mm	Conf.	Euro pz.
<b>381904</b>	E2	20						15,0	10	<b>4,74</b>
<b>381905</b>	E2	25						20,0	10	<b>7,28</b>



**Curve per sorpasso**

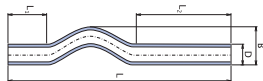

Codice	Classe	Dimensioni mm	A mm	A1 mm	A2 mm	B mm	L mm	L1 mm	L2 mm	Conf.	Euro pz.
<b>381804</b>	E2	20				25,0	400,0	80,0	210	10	<b>4,33</b>
<b>381805</b>	E2	25				34,0	400,0	80,0	150	10	<b>5,69</b>
<b>381806</b>	E2	32				64,0	390,0	64,0	136	5	<b>7,58</b>

R Contattare il Customer Service per tempistiche sulla disponibilita





**Giunti filettati maschio**

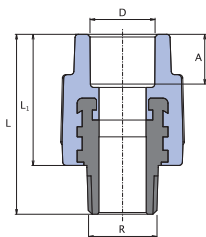

Codice	Classe	Dimensioni mm	A mm	A1 mm	A2 mm	B mm	L mm	L1 mm	L2 mm	Conf.	Euro pz.
<b>382114</b>	E2	20x1/2"	14,5				53,5	39,0		10	<b>8,47</b>
<b>382115</b>	E2	25x1/2"	16,0				55,5	41,0		10	<b>10,86</b>
<b>382125</b>	E2	25x3/4"	16,0				59,0	41,0		10	<b>11,71</b>
<b>382126</b>	E2	32x3/4"	18,0				60,0	44,0		10	<b>20,11</b>
<b>382136</b>	E2	32x1"	18,0				62,5	46,0		10	<b>23,51</b>
<b>382147</b>	E2	40x1" 1/4	20,5				80,0	48,0		5	<b>41,93</b>
<b>382158</b>	E2	50x1" 1/2	23,5				81,6	54,0		4	<b>48,56</b>
<b>382169</b>	E2	63x2"	27,5				101,0	63,5		2	<b>78,06</b>
<b>388177</b>	E2	75x2" 1/2	30,0				110,0	69,7		1	<b>203,33</b>
<b>R 388189</b>	E2	90x3"	33,0				130,0	85,0		1	<b>289,15</b>



**Giunti filettati femmina**

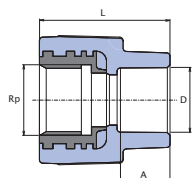

Codice	Classe	Dimensioni mm	A mm	A1 mm	A2 mm	B mm	B2 mm	L mm	Conf.	Euro pz.
<b>382014</b>	E2	20x1/2"	14,5					39,0	10	<b>8,40</b>
<b>R 382024</b>	E2	20x3/4"	14,5					42,0	10	<b>11,63</b>
<b>382015</b>	E2	25x1/2"	16,0					40,5	10	<b>10,36</b>
<b>382025</b>	E2	25x3/4"	16,0					47,0	10	<b>10,28</b>
<b>382026</b>	E2	32x3/4"	18,0					45,0	10	<b>16,18</b>
<b>382036</b>	E2	32x1"	18,0					57,0	10	<b>21,57</b>
<b>382047</b>	E2	40x1" 1/4	25,0					65,0	5	<b>36,50</b>
<b>382058</b>	E2	50x1" 1/2	23,5					69,0	4	<b>44,13</b>
<b>382069</b>	E2	63x2"	27,5					76,0	2	<b>69,51</b>
<b>R 382070</b>	E2	75x2" 1/2	28,0					65,5	1	<b>290,79</b>
<b>R 382080</b>	E2	90x3"	32,0					90,0	1	<b>331,31</b>

R Contattare il Customer Service per tempistiche sulla disponibilita

**Gomiti 90° filettati maschio**

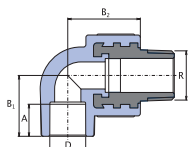

Codice	Classe	Dimensioni mm	A mm	A1 mm	A2 mm	B mm	B1 mm	B2 mm	L2 mm	Conf.	Euro pz.
<b>381114</b>	E2	20x1/2"	14,5				27,0	34,5		10	<b>10,52</b>
<b>R 381115</b>	E2	25x1/2"	16,0				31,0	36,0		10	<b>13,94</b>
<b>381125</b>	E2	25x3/4"	16,0				30,0	39,0		10	<b>13,00</b>
<b>381136</b>	E2	32x1"	18,0				36,0	41,6		5	<b>26,14</b>

**Gomiti 90° filettati femmina**

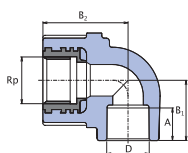

Codice	Classe	Dimensioni mm	A mm	A1 mm	A2 mm	B mm	B1 mm	B2 mm	L2 mm	Conf.	Euro pz.
<b>381014</b>	E2	20x1/2"	14,5				27,0	34,5		10	<b>8,77</b>
<b>381015</b>	E2	25x1/2"	16,0				31,0	36,0		10	<b>12,14</b>
<b>381025</b>	E2	25x3/4"	16,0				30,0	41,0		10	<b>12,49</b>
<b>381036</b>	E2	32x1"	18,0				36,0	51,0		10	<b>23,51</b>

**Gomiti 90° filettati femmina con staffa**

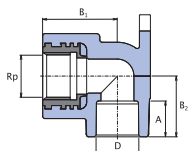

Codice	Classe	Dimensioni mm	A mm	A1 mm	A2 mm	B mm	B1 mm	B2 mm	L2 mm	Conf.	Euro pz.
<b>381304</b>	E2	20x1/2"	14,5				34,0	26,8		10	<b>9,00</b>
<b>R 381325</b>	E2	25x3/4"	16,0				40,0	40,0		10	<b>12,29</b>

R Contattare il Customer Service per tempistiche sulla disponibilita



**Gomito 90° filettato maschio con staffa**

Codice	Classe	Dimensioni mm	t1 mm	t2 mm	L1 mm	L2 mm	X1 mm	X2 mm	L2 mm	Conf.	Euro pz.
<b>R 381314</b>	E2	20x1/2"	15,0	15,0	26,5	50,0	50,0	62,0		10	<b>12,81</b>

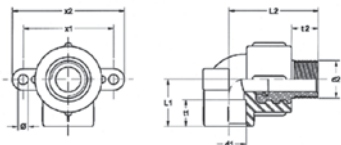

**Gomito 90° filettato femmina con attacco maschio con staffa**

Codice	Classe	Dimensioni mm	A mm	A1 mm	B mm	B1 mm	B2 mm	C mm	Conf.	Euro pz.
<b>381515</b>	E2	20x1/2"				35,0	35,0	11,0	10	<b>9,08</b>

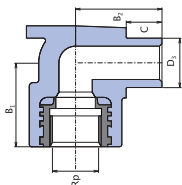

**T Passante con staffa**

Codice	Classe	Dimensioni mm	A mm	A1 mm	B mm	B1 mm	Ro mm	L mm	Conf.	Euro pz.
<b>383214</b>	E2	20x1/2"			50,0		66,0	28,5	20	<b>14,94</b>

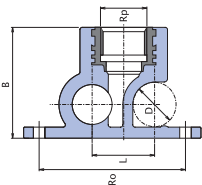

**R** Contattare il Customer Service per tempistiche sulla disponibilita



**T filettati femmina**

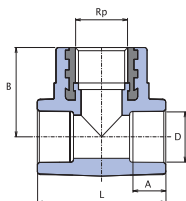

Codice	Classe	Dimensioni mm	A mm	A1 mm	A2 mm	B mm	B2 mm	L mm	Conf.	Euro pz.
<b>383014</b>	E2	20x1/2"	14,5			34,0		51,5	10	<b>13,16</b>
<b>383015</b>	E2	25x1/2"	16,0			40,0		80,0	10	<b>13,42</b>
<b>383025</b>	E2	25x3/4"	16,0			40,0		80,0	5	<b>14,18</b>
<b>R 383026</b>	E2	32x3/4"	18,0			42,0		71,0	5	<b>23,51</b>
<b>383036</b>	E2	32x1"	18,0			55,0		80,0	5	<b>24,53</b>



**T filettati maschio**

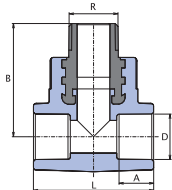

Codice	Classe	Dimensioni mm	A mm	A1 mm	A2 mm	B mm	B1 mm	B2 mm	L	Conf.	Euro pz.
<b>R 383114</b>	E2	20x1/2"	14,5			48,5			51,5	10	<b>12,65</b>



**Selle a saldare**

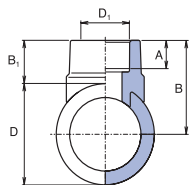

Codice	Classe	Dimensioni mm	A mm	A1 mm	A2 mm	B mm	B1 mm	B2 mm	L2 mm	Conf.	Euro pz.
<b>386066</b>	E2	63x32	18,0			58,5	27,0			10	<b>8,35</b>
<b>386076</b>	E2	75x32	18,0			64,5	27,0			10	<b>8,68</b>
<b>R 386096</b>	E2	90x32	18,0			72,0	27,0			10	<b>9,22</b>
<b>386106</b>	E2	110x32	18,0			80,7	25,7			10	<b>12,42</b>
<b>386107</b>	E2	110x40	21,0			80,7	25,7			10	<b>13,43</b>
<b>386108</b>	E2	125x32	18			84,5	22			10	<b>12,93</b>
<b>386109</b>	E2	125x40	21			90,5	28			10	<b>13,78</b>
<b>386110</b>	E2	125x50	23,5			92	29,5			5	<b>13,99</b>
<b>386111</b>	E2	125x63	27,5			99,5	37			5	<b>14,11</b>

R Contattare il Customer Service per tempistiche sulla disponibilità



**Selle a saldare flettate femmina**

Codice	Classe	Dimensioni mm	A mm	A1 mm	A2 mm	B mm	B1 mm	B2 mm	L2 mm	Conf.	Euro pz.
<b>386266</b>	E2	63x3/4"				58,5	27,0			10	<b>18,34</b>
<b>386276</b>	E2	75x3/4"				64,5	27,0			10	<b>20,16</b>
<b>386296</b>	E2	90x3/4"				72,0	27,0			10	<b>20,98</b>

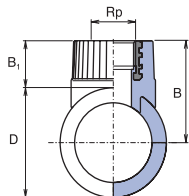

**Selle a saldare flettate maschio**

Codice	Classe	Dimensioni mm	A mm	A1 mm	A2 mm	B mm	B1 mm	B2 mm	L2 mm	Conf.	Euro pz.
R <b>386366</b>	E2	63x3/4"				76,3	44,8			10	<b>20,16</b>
R <b>386376</b>	E2	75x3/4"				82,3	44,8			10	<b>21,84</b>
R <b>386396</b>	E2	90x3/4"				89,8	44,8			10	<b>22,82</b>

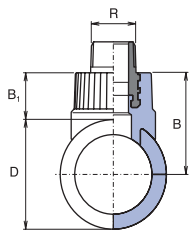

**Rubinetti ad incasso**

Codice	Classe	Dimensioni mm	A mm	A1 mm	A2 mm	B mm	B1 mm	B2 mm	L mm	Conf.	Euro pz.
<b>361004</b>	WG	20	14,5			27,5			69,0	5	<b>39,20</b>
<b>361005</b>	WG	25	14,5			30,0			80,0	5	<b>43,36</b>

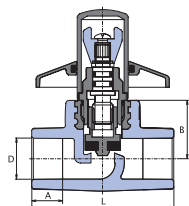

R Contattare il Customer Service per tempistiche sulla disponibilità



**Rubinetti a maniglia**

Codice	Classe	Dimensioni mm	A mm	A1 mm	A2 mm	B mm	B1 mm	B2 mm	L mm	Conf.	Euro pz.
<b>361014</b>	WG	20	14,5			27,5			69,0	5	<b>56,97</b>
<b>R 361015</b>	WG	25	14,5			30,0			80,0	5	<b>70,27</b>

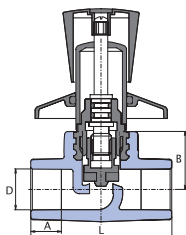

**Kit prolunga rubinetto incasso**

Codice	Classe	Descrizione	Conf.	Euro pz.
<b>R 361002</b>	WG	Green	1	<b>45,09</b>
<b>361012</b>	WG	EKO (per rubinetti Ekoplastik)	1	<b>15,68</b>



**Valvole a sfera**

Codice	Classe	Dimensioni mm	A mm	A1 mm	A2 mm	B mm	B1 mm	B2 mm	L mm	Conf.	Euro pz.
<b>361054N</b>	WG	20	14,5			67,0			65,0	5	<b>64,51</b>
<b>R 361055N</b>	WG	25	16,5			65,0			71,0	1	<b>68,31</b>

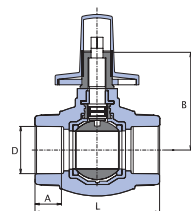

**R** Contattare il Customer Service per tempistiche sulla disponibilita

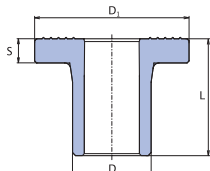

**Cartelle per flange**

Codice	Classe	Dimensioni mm	A mm	A1 mm	A2 mm	B mm	D1 mm	S mm	L mm	Conf.	Euro pz.
R <b>361239</b>	X3	75					123,0	14,7	73,0	1	<b>21,18</b>
R <b>361240</b>	X3	90					140,0	17,0	92,0	1	<b>29,37</b>
R <b>361241</b>	X3	110					160,0	19,0	103,0	1	<b>43,62</b>
R <b>361242</b>	X3	125					188,0	20,0	63,0	1	<b>59,17</b>

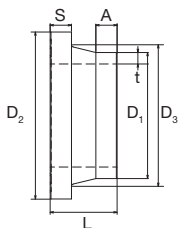

**Cartelle per flange PP-RCT S5/SDR11 Saldatura T/T**

Codice	Classe	Dimensioni mm	D2 mm	D3 mm	S mm	A mm	T mm	L mm	Conf.	Euro pz.
R <b>361243</b>	X3	160	212,0	175,0	27,0	27,0	14,6	85,0	1	<b>136,09</b>
R <b>361244</b>	X3	200	268,0	232,0	34,0	50,0	18,2	130,0	1	<b>270,76</b>
R <b>361245</b>	X3	250	320,0	285,0	36,0	38,0	22,7	121,0	1	<b>305,53</b>

R Contattare il Customer Service per tempistiche sulla disponibilita



**Flange**

Codice	Classe	d. mm	DN mm	D mm	D1 mm	D2 mm	D3 mm	H	Num.	Conf.	Euro pz.
<b>905004</b>	W3	75	65	185	145	92	18	20	4	1	<b>50,93</b>
<b>905005</b>	W3	90	80	200	160	108	18	20	8	1	<b>52,22</b>
<b>905006</b>	W3	110	100	220	180	128	18	20	8	1	<b>67,72</b>
<b>R 361252</b>	X3	125	125	250	210	166	20	18	8	1	<b>143,12</b>
<b>905009</b>	W3	160	150	285	240	178	22	20	8	1	<b>126,25</b>
<b>904475</b>	W3	200	200	340	295	235	22	24	12	1	<b>128,80</b>
<b>R 904477</b>	W3	250	250	405	355	288	26	30	12	1	<b>229,83</b>

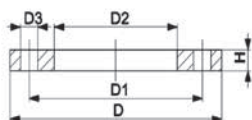

**Guarnizione per flange EPDM**

Codice	Classe	Dimensioni mm	A mm	A1 mm	d1 mm	d2 mm	b mm	Fori	Conf.	Euro pz.
<b>904406</b>	W3	75/DN 65			127,0	67,0	3,0		10	<b>5,08</b>
<b>904407</b>	W3	90/DN 80			142,0	84,0	3,0		10	<b>6,47</b>
<b>904408</b>	W3	110/DN 100			162,0	103,0	3,0		10	<b>7,29</b>

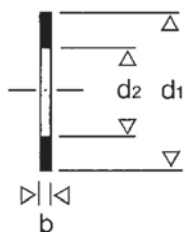

**Tappi prova impianto**

Codice	Classe	Descrizione	Conf.	Euro pz.
<b>609945</b>	X4	Rosso 1/2"	100	<b>1,32</b>
<b>609946</b>	X4	Blu 1/2"	100	<b>1,32</b>
<b>609947</b>	X4	Rosso 3/4"	100	<b>3,54</b>
<b>609948</b>	X4	Blu 3/4"	100	<b>3,54</b>



R Contattare il Customer Service per tempistiche sulla disponibilita





**Dima per terminali con staffa**

Codice	Classe	Dimensioni mm	A mm	B mm	C mm	D mm	E mm	F mm	Conf.	Euro pz.
<b>R 389907</b>	X3		220,0	64,0	135,0	110,0	45,0	40,0	10	<b>6,31</b>

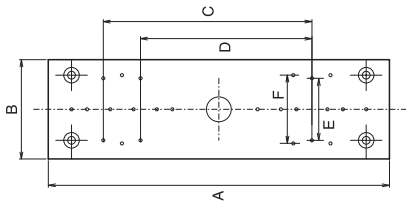

**Tappo riparafori**

Codice	Classe	Dimensioni mm	Col.	B mm	C mm	D mm	E mm	L mm	Conf.	Euro pz.
<b>361040</b>	X3	7							1	<b>4,20</b>

R Contattare il Customer Service per tempistiche sulla disponibilita



**Polifusore TF-E 63 con cassetta metallica**

Codice	Classe	Descrizione	Conf.	Euro pz.
<b>361170</b>	X3	Con valigia TF-E63	1	<b>581,41</b>

**DATI TECNICI**

- Bussole escluse
- Termostato elettronico regolabile da 180° C a 290° C
- Campo di lavoro con bussole Ø 20-63
- Peso 1,8 kg
- Dimensioni: 175 x 50 x 360
- Potenza massima assorbita 800 W
- Alimentazione 220V~50Hz



**Polifusore TF-E 125 con cassetta metallica**

Codice	Classe	Descrizione	Conf.	Euro pz.
<b>R 361172</b>	X3	Con valigia TF-E125	1	<b>1.663,37</b>

**DATI TECNICI**

- Bussole escluse
- Termostato elettronico regolabile da 180° C a 290° C
- Campo di lavoro con bussole Ø 20-125
- Peso 3,16 kg
- Dimensioni: 175 x 50 x 395
- Potenza massima assorbita 1400 W
- Alimentazione 220V~50Hz

**Bussole per polifusore**



Codice	Classe	Descrizione	Conf.	Euro pz.
<b>R 361084</b>	X3	Ø20	1	<b>72,31</b>
<b>R 361085</b>	X3	Ø25	1	<b>91,27</b>
<b>R 361086</b>	X3	Ø32	1	<b>92,62</b>
<b>R 361087</b>	X3	Ø40	1	<b>110,87</b>
<b>R 361088</b>	X3	Ø50	1	<b>130,15</b>
<b>R 361089</b>	X3	Ø63	1	<b>156,10</b>
<b>R 361090</b>	X3	Ø75	1	<b>190,51</b>
<b>R 361091</b>	X3	Ø90	1	<b>213,62</b>
<b>R 361092</b>	X3	Ø110	1	<b>267,07</b>

**Bussole per selle**

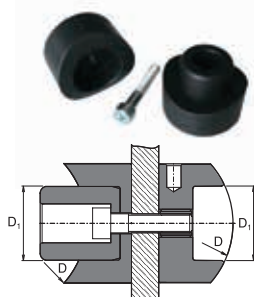

Codice	Classe	Descrizione	Conf.	Euro pz.
<b>R 361096</b>	X3	63/32	1	<b>193,85</b>
<b>R 361098</b>	X3	75/32	1	<b>193,85</b>
<b>R 361099</b>	X3	90/32	1	<b>193,85</b>
<b>R 361100</b>	X3	110/32-40	1	<b>197,18</b>
<b>R 361200</b>	X3	125/40-32	1	<b>198,13</b>
<b>R 361201</b>	X3	125/63-50	1	<b>260,17</b>

**R** Contattare il Customer Service per tempistiche sulla disponibilità

**Fresa per selle**

Codice	Classe	Dimensioni mm	Conf.	Euro pz.
R <b>361106</b>	X3	32	1	<b>141,58</b>
R <b>361107</b>	X3	40	1	<b>201,23</b>

**Matrici riparafori**

Codice	Classe	Descrizione	Conf.	Euro pz.
R <b>361095</b>	X3	Ø 7 - 8 mm	1	<b>110,70</b>

**Cesoia**

Codice	Classe	Descrizione	Conf.	Euro pz.
R <b>360421</b>	X3	Cesoia Ø 14-32	1	<b>107,24</b>

**Tagliatubi**

Codice	Classe	Descrizione	Conf.	Euro pz.
R <b>577913</b>	X2	Tagliatubi Ø 0 - 75	1	<b>300,55</b>
<b>577915</b>	X2	Tagliatubi Ø 50 - 140	1	<b>375,42</b>

**Saldatrice PRISMA JIG**

Codice	Classe	Descrizione	Conf.	Euro pz.
R <b>361110</b>	X3	Saldatrice compatta per giunti a bicchiere Ø 63 - 125 Completa di bussole 63-125	1	<b>8.364,63</b>

**DOTAZIONE DI SERIE**

- Corpo macchina completa di morse e telaio
- Polifusore TF-E 125
- Bussola Ø63 - Ø75 - Ø90 - Ø110 - Ø125
- Cassa di trasporto per bussole e polifusore- Dimensioni: 175 x 50 x 395
- Cassa di trasporto macchina
- Perno di sostegno
- Chiave di servizio

**DATI TECNICI**

- Campo di lavoro Ø 63-Ø 125
- Alimentazione 230V -monofase 50/60Hz
- Potenza massima assorbita 1400W
- Temperatura di esercizio 260°C (±10°C)
- Temperatura ambiente di lavoro -5°C +40°C
- Materiali PP-R
- Peso complessivo 16 kg

R Contattare il Customer Service per tempistiche sulla disponibilita



**Saldatrice Polivalente WLW125 R con scanner**

Codice	Classe	Descrizione	Conf.	Euro pz.
<b>574690</b>	X2	Saldatrice polivalente completa di scanner, borsa di trasporto e raschietto	1	<b>2.960,64</b>

**Saldatrice Polivalente WLW500**



Codice	Classe	Alim. V	Sald. V	Frequ. Hz	Lungh. mm	Largh. mm	Altez. mm	peso kg	Conf.	Euro pz.
<b>574710</b>	X2	220-230	8-48	50 - 60	255	270	385	18	1	<b>6.183,38</b>

Completa di scanner, raschietto, connettori universali 4-4,7, cassa di trasporto in alluminio

## Ricambi

Codice	Classe	Descrizione	Euro pz.
R <b>361990</b>	WG	Vitone 1/2" per rubinetto incasso Green	<b>30,69</b>
R <b>361991</b>	WG	Vitone 3/4" per rubinetto incasso Green	<b>51,42</b>
R <b>361992</b>	WG	Manettino per rubinetto incasso Green	<b>4,94</b>
R <b>361993</b>	WG	Vite per manettino 11 mm per rubinetto incasso Green	<b>35,06</b>
R <b>361998</b>	WG	Rosetta ottone per rubinetto incasso Green	<b>46,87</b>
R <b>361999</b>	WG	Canotto cromato chiuso per rubinetto incasso Green	<b>26,06</b>
R <b>360200</b>	WG	Kit Rosetta, canotto e vitone per rubinetto 20 EKO	<b>49,64</b>
R <b>360201</b>	WG	Kit Rosetta, canotto e vitone per rubinetto 25 EKO	<b>57,56</b>
R <b>360202</b>	WG	Kit Rosetta, canotto, maniglia e vitone 1/2" per rubinetto 20 EKO	<b>67,62</b>
R <b>360203</b>	WG	Kit Rosetta, canotto, maniglia e vitone 3/4" per rubinetto 25 EKO	<b>72,20</b>
R <b>360204</b>	WG	Manettino per rubinetti 20-25 EKO	<b>1,78</b>
R <b>577914</b>	X2	Lama di ricambio per tagliatubi TU 0/75 (cod. 577 913)	<b>67,35</b>
R <b>577916</b>	X2	Lama di ricambio per tagliatubi TU 50/140 (cod. 577 915)	<b>122,06</b>

R Contattare il Customer Service per tempistiche sulla disponibilita



# Wavin PE



**GAMMA**

Il sistema Wavin PE è una linea completa di tubi e raccordi, conforme alla EN 1519, disponibile dal diametro 32 al 315, per applicazioni BD (interne all'edificio ed esterne ad un metro di distanza dal perimetro).

<b>Diametro nominale mm</b>	<b>Spessore mm</b>	<b>Serie</b>
32	3,0-3,5	12,5
40	3,0-3,5	12,5
50	3,0-3,5	12,5
63	3,0-3,5	12,5
75	3,0-3,5	12,5
90	3,5-4,1	12,5
110	4,2-4,9	12,5
125	4,9-5,6	12,5
160	6,2-7,1	12,5
200	6,2-7,1	16
250	7,7-8,7	16
315	9,7-10,9	16

**SPECIFICHE TECNICHE****Materia prima**

Polietilene alta densità.

**Metodo di giunzione**

Giunzione attraverso l'elettrofusione, la saldatura testa a testa, i manicotti ad innesto, i manicotti di dilatazione, il raccordo a vite oppure la giunzione flangiata.

**Densità**

≈ 0,956 gr/cm<sup>3</sup> in accordo alla EN ISO 1183-1

**Temperatura di esercizio**

90°C temperatura massima; 100°C per brevi periodi

**Coefficiente di dilatazione**

0,2 mm/m/K

**Rigidità anulare**

SN ≥ 4 KN/m<sup>2</sup> test in accordo alla EN ISO 9969

**Certificato di conformità**

IIP (n°1881 - 1892 - 1886)



## APPLICAZIONI

Wavin PE può essere utilizzato sia nel civile che nell'industriale, per condotte adibite allo scarico di apparecchi sanitari, lavatrici, lavastoviglie, scarico prolungato di acqua usata (da grandi cucine o lavanderie); la maggior parte dei prodotti Wavin PE trova impiego anche per impianti di drenaggio sifonico delle acque meteoriche dalle coperture (Sistema Wavin Quickstream).

## CERTIFICAZIONI

I componenti del sistema Wavin PE soddisfano i requisiti della norma europea EN1519 e di applicazione EN12056-2. L'azienda soddisfa i requisiti di qualità secondo le norme ISO 9001 e requisiti ambientali secondo la norma ISO 14001.

## VANTAGGI DEL SISTEMA

### Resistenza agli scarichi delle lavatrici e lavastoviglie

Alta resistenza alle acque bollenti con punte di temperatura fino a 100°C.

### Resistenza alle basse temperature

Grazie alla sua elasticità risulta resistente anche nell'eventualità di gelo.

### Resistenza all'abrasione

Grazie agli spessori ed alle caratteristiche di compattezza, il Wavin PE resiste a possibili particelle che si trovano all'interno delle tubazioni.

### Mancanza di intasamenti

Le pareti perfettamente lisce dei tubi e raccordi permettono un deflusso regolare.

### Elasticità

Il sistema è idoneo per essere utilizzato in zone sismiche o nell'attraversamento di giunti di dilatazione nelle costruzioni.

### Resistenza all'urto

Grazie anche alla sua elasticità, resiste fino a punte di -40°C.

### Comportamento al fuoco

Durante la combustione, il Wavin PE non sprigiona gas tossici.

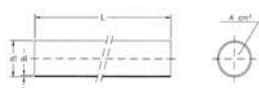

**Tubi**

Codice	Classe	d1	di	x1	S	L	H	A cm <sup>2</sup>	Pallet	Conf.	Euro pz.
<b>920001</b>	B1	32	26		3,0	3000		4,7	366	14	<b>24,12</b>
<b>920003</b>	B1	40	34		3,0	5000		9,0	168	1	<b>46,68</b>
<b>920005</b>	B1	50	44		3,0	5000		15,2	209	1	<b>56,70</b>
<b>920007</b>	B1	63	57		3,0	5000		25,4	135	1	<b>73,27</b>
<b>920008</b>	B1	75	69		3,0	5000		37,3	100	1	<b>85,13</b>
<b>920009</b>	B1	90	83		3,5	5000		54,1	63	1	<b>117,74</b>
<b>920010</b>	B1	110	101,4		4,2	5000		80,7	43	1	<b>184,70</b>
<b>920011</b>	B1	125	115,2		4,8	5000		104,2	30	1	<b>228,10</b>
<b>920013</b>	B1	160	147,6		6,2	5000		171,1	22	1	<b>380,35</b>
<b>920015</b>	B1	200	187,6		6,2	5000		276,4	14	1	<b>496,47</b>
<b>920017</b>	B1	250	234,4		7,7	5000		431,5	14	1	<b>841,96</b>
<b>920019</b>	B1	315	295,4		9,7	5000		685,3	8	1	<b>1.358,78</b>

Tubi: da Ø32 al Ø160 serie S12,5 e da Ø200 al Ø315 serie S16

**Riduzioni concentriche**

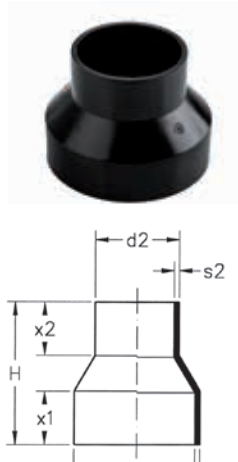

Codice	Classe	d1/d2	di	x1	x2	H	Pallet	Conf.	Euro pz.
<b>920508</b>	B3	40/ 32		30	30	80		20	<b>4,52</b>
<b>920516</b>	B3	50/ 40		30	30	80		60	<b>3,49</b>
<b>920525</b>	B3	63/ 40		30	30	80		20	<b>6,77</b>
<b>920526</b>	B3	63/ 50		30	30	80		20	<b>6,34</b>
<b>920531</b>	B3	75/ 50		30	30	80		20	<b>5,87</b>
<b>920533</b>	B3	75/ 63		30	30	80		20	<b>6,44</b>
<b>920536</b>	B3	90/ 50		30	30	80		20	<b>6,93</b>
<b>920538</b>	B3	90/ 63		30	30	80		20	<b>7,48</b>
<b>920539</b>	B3	90/ 75		30	30	80		20	<b>6,93</b>
<b>920543</b>	B3	110/ 50		30	30	80		10	<b>8,66</b>
<b>920545</b>	B3	110/ 63		30	30	80		10	<b>8,35</b>
<b>920546</b>	B3	110/ 75		30	30	80		10	<b>8,23</b>
<b>920547</b>	B3	110/ 90		30	30	80		10	<b>7,82</b>
<b>920552</b>	B3	125/ 63		30	30	80		20	<b>16,35</b>
<b>920555</b>	B3	125/110		30	30	80		10	<b>15,78</b>
<b>920558</b>	B3	160/110		35	35	100		5	<b>29,17</b>
<b>920560</b>	B3	160/125		35	35	100		5	<b>26,65</b>
<b>920562S</b>	B3	200/160		120	100	250		1	<b>188,80</b>
<b>920564S</b>	B3	250/200		140	120	270		1	<b>271,57</b>
<b>920566S</b>	B3	315/250		150	130	325		1	<b>359,18</b>



**Riduzioni eccentriche**

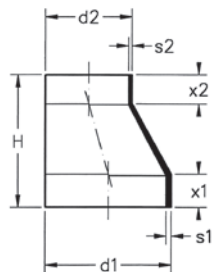
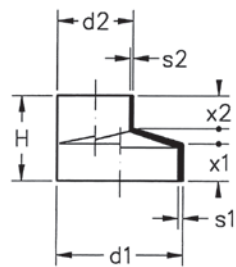

cod.  
**920 675**  
**920 676**  
**920 678**  
**920 690S**  
**920 698S**

Codice	Classe	d1/d2	di	x1	x2	H	Pallet	Conf.	Euro pz.
<b>920608</b>	B3	40/ 32		25,5	25,5	65		20	<b>10,63</b>
<b>920616</b>	B3	50/ 40		35	37	80		20	<b>6,13</b>
<b>920625</b>	B3	63/ 40		35	37	80		20	<b>26,01</b>
<b>920626</b>	B3	63/ 50		35	37	80		20	<b>7,05</b>
<b>920630</b>	B3	75/ 40		33	30	80		20	<b>8,15</b>
<b>920631</b>	B3	75/ 50		35	37	80		20	<b>8,11</b>
<b>920633</b>	B3	75/ 63		35	37	80		20	<b>8,04</b>
<b>920635</b>	B3	90/ 40		30	34	80		20	<b>34,09</b>
<b>920636</b>	B3	90/ 50		31	34	80		20	<b>10,43</b>
<b>920638</b>	B3	90/ 63		31	38	80		20	<b>10,43</b>
<b>920639</b>	B3	90/ 75		31	43	80		20	<b>10,21</b>
<b>920642</b>	B3	110/ 40		31	34	80		20	<b>33,93</b>
<b>920643</b>	B3	110/ 50		31	34	80		20	<b>12,01</b>
<b>920645</b>	B3	110/ 63		35	37	80		20	<b>12,21</b>
<b>920646</b>	B3	110/ 75		31	36	80		20	<b>12,01</b>
<b>920647</b>	B3	110/ 90		35	37	80		20	<b>11,31</b>
<b>920653</b>	B3	125/ 75		35	30	80		10	<b>21,13</b>
<b>920654</b>	B3	125/ 90		35	32	80		10	<b>20,75</b>
<b>920655</b>	B3	125/110		36	36	80		10	<b>19,26</b>
<b>920671</b>	B3	160/110		35	37	80		5	<b>35,10</b>
<b>920672</b>	B3	160/125		35	37	80		5	<b>35,10</b>
<b>920675</b>	B3	L.A. 200/110		110	60	325		5	<b>197,52</b>
<b>920676</b>	B3	L.A. 200/125		110	70	310		1	<b>243,75</b>
<b>920678</b>	B3	L.A. 200/160		110	90	270		1	<b>257,18</b>
<b>920690S</b>	B3	L.A. 250/200		130	110	325		1	<b>320,02</b>
<b>920698S</b>	B3	L.A. 315/250		150	130	395		1	<b>427,56</b>



**Curva 15°**

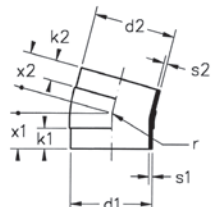

Codice	Classe	d1	a	x1	r	Pallet	Conf.	Euro pz.
<b>921542</b>	B3	110	15°	45	80		20	<b>28,78</b>



**Curve 45°**

Codice	Classe	d1=d2	x1=x2	Pallet	Conf.	Euro pz.
<b>921232</b>	B3	32	25	3840	30	<b>5,53</b>
<b>921234</b>	B3	40	40	3840	120	<b>5,53</b>
<b>921254</b>	B3	50	45	2560	40	<b>6,12</b>
<b>921274</b>	B3	63	50	1280	20	<b>8,96</b>
<b>921284</b>	B3	75	50	960	20	<b>13,91</b>
<b>921294</b>	B3	90	55	640	20	<b>21,48</b>
<b>921304</b>	B3	110	60	400	25	<b>21,43</b>
<b>921314</b>	B3	125	65	240	10	<b>33,63</b>
<b>921334</b>	B3	160	100	80	5	<b>95,82</b>
<b>921354</b>	B3	200 Raggio corto 45°	160	40	5	<b>170,80</b>
<b>921374S</b>	B3	250 Segmentata 45°	222	20	1	<b>255,38</b>
<b>921394S</b>	B3	315 Segmentata 45°	247	8	1	<b>373,86</b>

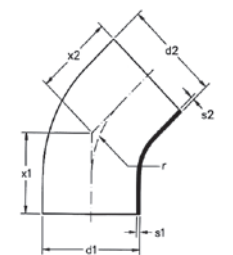
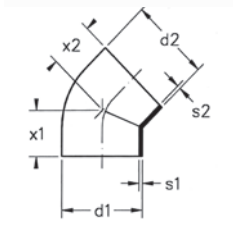

**921 354**



**Segmentata**

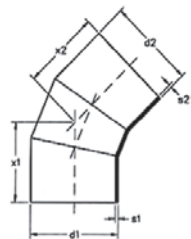

**921 374S  
921 394S**



**Curve 88° 1/2**

Codice	Classe	d1=d2	x1=x2	Pallet	Conf.	Euro pz.
<b>921238</b>	B3	40	60	3200	40	<b>5,53</b>
<b>921258</b>	B3	50	70	1600	20	<b>5,62</b>
<b>921519</b>	B3	63	80	960	20	<b>9,05</b>
<b>921528</b>	B3	75	75	640	20	<b>14,43</b>
<b>921298</b>	B3	90 Raggio corto	80	480	20	<b>21,79</b>
<b>921548</b>	B3	110	110	240	20	<b>22,65</b>
<b>921558</b>	B3	125	125	160	10	<b>35,57</b>
<b>921568</b>	B3	160	180	60	5	<b>101,34</b>

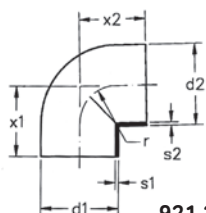
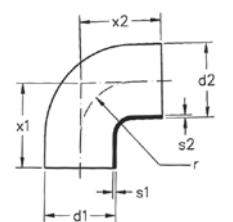

**921 298**

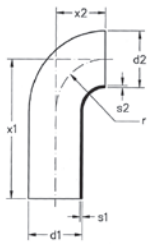

**Curve 90° prolungate**

Codice	Classe	d1=d2	x1	x2	r	Pallet	Conf.	Euro pz.
<b>921002</b>	B3	32	100	30	30	3840	30	<b>6,12</b>
<b>921003</b>	B3	40	150	30	30	1920	40	<b>6,05</b>
<b>921005</b>	B3	50	180	40	40	960	30	<b>6,48</b>
<b>921007</b>	B3	63	210	50	50	640	20	<b>10,97</b>
<b>921008</b>	B3	75	210	70	70	400	25	<b>17,67</b>
<b>921009</b>	B3	90	240	90	90	200	25	<b>23,84</b>
<b>921010</b>	B3	110	270	103	100	160	20	<b>28,40</b>
<b>921011</b>	B3	125	200	110	110	120	10	<b>35,36</b>

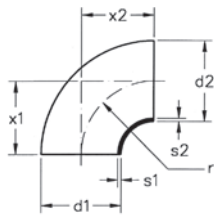

**Curve 90°**

Codice	Classe	d1=d2	x1=x2	Pallet	Conf.	Euro pz.
<b>921013</b>	B3	160 Raggio corto	140	80	10	<b>106,68</b>
<b>921015S</b>	B3	200 Segmentata	292	24	1	<b>305,90</b>
<b>921017S</b>	B3	250 Segmentata	391	12	1	<b>605,84</b>
<b>921019S</b>	B3	315 Segmentata	438	6	1	<b>866,62</b>

**921 013**

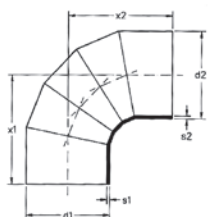

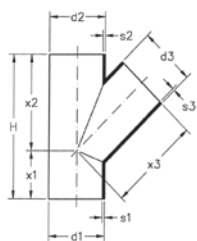

**Braghe 45° semplici e ridotte**

Codice	Classe	d1=d2	d3	x1	x2=x3	H	Pallet	Conf.	Euro pz.
<b>922005</b>	B3	32	32	35	70	105	2560	20	<b>11,87</b>
<b>922008</b>	B3	40	32	45	90	135	1280	20	<b>10,40</b>
<b>922009</b>	B3	40	40	45	90	135	1280	20	<b>11,47</b>
<b>922016</b>	B3	50	40	55	110	165	800	50	<b>11,87</b>
<b>922018</b>	B3	50	50	55	110	165	800	25	<b>12,66</b>
<b>922025</b>	B3	63	40	65	130	195	640	20	<b>17,91</b>
<b>922026</b>	B3	63	50	65	130	195	640	20	<b>17,43</b>
<b>922028</b>	B3	63	63	65	130	195	480	20	<b>17,33</b>
<b>922030</b>	B3	75	40	70	140	210	320	20	<b>21,28</b>
<b>922031</b>	B3	75	50	70	140	210	320	20	<b>20,70</b>
<b>922033</b>	B3	75	63	70	140	210	320	20	<b>21,11</b>
<b>922034</b>	B3	75	75	70	140	210	320	20	<b>20,80</b>
<b>922035</b>	B3	90	40	80	160	240	320	10	<b>26,26</b>
<b>922036</b>	B3	90	50	80	160	240	240	10	<b>26,26</b>
<b>922038</b>	B3	90	63	80	160	240	160	10	<b>28,22</b>
<b>922039</b>	B3	90	75	80	160	240	160	10	<b>26,65</b>
<b>922040</b>	B3	90	90	80	160	240	240	15	<b>26,57</b>
<b>922042</b>	B3	110	40	90	180	270	160	10	<b>31,41</b>
<b>922043</b>	B3	110	50	90	180	270	160	10	<b>31,02</b>
<b>922045</b>	B3	110	63	90	180	270	160	10	<b>32,87</b>
<b>922046</b>	B3	110	75	90	180	270	160	10	<b>32,87</b>
<b>922047</b>	B3	110	90	90	180	270	120	10	<b>33,83</b>
<b>922048</b>	B3	110	110	90	180	270	120	15	<b>31,79</b>
<b>922050</b>	B3	125	50	100	200	300	120	10	<b>37,23</b>
<b>922052</b>	B3	125	63	100	200	300	120	10	<b>42,76</b>
<b>922053</b>	B3	125	75	100	200	300	120	10	<b>42,61</b>
<b>922054</b>	B3	125	90	100	200	300	80	10	<b>44,14</b>
<b>922055</b>	B3	125	110	100	200	300	80	10	<b>42,64</b>
<b>922056</b>	B3	125	125	100	200	300	80	5	<b>43,06</b>
<b>922071</b>	B3	160	110	125	250	375	40	5	<b>144,36</b>
<b>922072</b>	B3	160	125	125	250	375	40	5	<b>134,27</b>
<b>922074</b>	B3	160	160	125	250	375	40	5	<b>145,89</b>
<b>922075S</b>	B3	200	110	180	360	540	20	5	<b>307,98</b>
<b>922076S</b>	B3	200	125	180	360	540	16	1	<b>325,55</b>
<b>922078S</b>	B3	200	160	180	360	540	20	1	<b>343,27</b>
<b>922079S</b>	B3	200	200	180	360	540	20	5	<b>333,86</b>
<b>922086S</b>	B3	250	110	220	440	660	10	1	<b>465,49</b>
<b>922087S</b>	B3	250	125	220	440	660	10	1	<b>465,49</b>
<b>922089S</b>	B3	250	160	220	440	660	10	1	<b>490,40</b>
<b>922090S</b>	B3	250	200	220	440	660	8	1	<b>518,23</b>
<b>922092S</b>	B3	250	250	220	440	660	6	1	<b>569,30</b>
<b>922093S</b>	B3	315	110	280	560	840	4	1	<b>598,09</b>
<b>R 922094S</b>	B3	315	125	280	560	840	4	1	<b>598,09</b>
<b>922095S</b>	B3	315	160	280	560	840	4	1	<b>609,86</b>
<b>922096S</b>	B3	315	200	280	560	840	4	1	<b>633,94</b>
<b>922098S</b>	B3	315	250	280	560	840	4	1	<b>699,69</b>
<b>922099S</b>	B3	315	315	280	560	840	4	1	<b>764,46</b>

R Contattare il Customer Service per tempistiche sulla disponibilita

**Braghe 88° 1/2 semplici e ridotte**

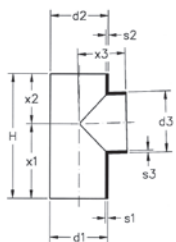

Codice	Classe	d1=d2	d3	x1	x2=x3	H	Pallet	Conf.	Euro pz.
<b>922205</b>	B3	32	32	50	50	100	2560	20	<b>12,47</b>
<b>922209</b>	B3	40	40	75	55	130	1600	20	<b>10,43</b>
<b>922216</b>	B3	50	40	90	60	150	640	40	<b>12,04</b>
<b>922218</b>	B3	50	50	90	60	150	960	20	<b>12,40</b>
<b>922226</b>	B3	63	50	105	70	175	640	20	<b>17,98</b>
<b>922228</b>	B3	63	63	105	70	175	640	20	<b>17,98</b>
<b>922231</b>	B3	75	50	105	70	175	480	20	<b>22,00</b>
<b>922233</b>	B3	75	63	105	70	175	480	20	<b>21,00</b>
<b>922234</b>	B3	75	75	105	70	175	480	20	<b>21,48</b>
<b>922235</b>	B3	90	40	120	80	200	320	10	<b>26,65</b>
<b>922236</b>	B3	90	50	120	80	200	320	10	<b>26,65</b>
<b>922238</b>	B3	90	63	120	80	200	320	10	<b>27,24</b>
<b>922239</b>	B3	90	75	120	80	200	320	10	<b>26,92</b>
<b>922240</b>	B3	90	90	120	80	200	320	10	<b>26,34</b>
<b>922242</b>	B3	110	40	135	90	225	160	10	<b>31,98</b>
<b>922243</b>	B3	110	50	135	90	225	160	10	<b>31,98</b>
<b>922245</b>	B3	110	63	135	90	225	160	10	<b>31,91</b>
<b>922246</b>	B3	110	75	135	90	225	160	10	<b>31,98</b>
<b>922247</b>	B3	110	90	135	90	225	160	10	<b>32,21</b>
<b>922248</b>	B3	110	110	135	90	225	180	15	<b>31,11</b>
<b>922252</b>	B3	125	63	150	100	250	160	10	<b>43,01</b>
<b>922255</b>	B3	125	110	150	100	250	120	10	<b>42,02</b>
<b>922256</b>	B3	125	125	150	100	250	120	10	<b>44,37</b>
<b>R 922271</b>	B3	160	110	210	140	350	60	5	<b>128,63</b>
<b>R 922272</b>	B3	160	125	210	140	350	60	5	<b>139,80</b>
<b>922274</b>	B3	160	160	210	140	350	60	5	<b>132,49</b>
<b>922275S</b>	B3	200	110	220	220	440	30	1	<b>260,63</b>
<b>R 922276S</b>	B3	200	125	220	220	440	30	1	<b>260,63</b>
<b>922278S</b>	B3	200	160	220	220	440	24	1	<b>266,87</b>
<b>922279S</b>	B3	200	200	220	220	440	24	1	<b>271,30</b>
<b>R 922286S</b>	B3	250	110	260	260	520	18	1	<b>363,62</b>
<b>R 922287S</b>	B3	250	125	260	260	520	18	1	<b>364,44</b>
<b>922289S</b>	B3	250	160	260	260	520	16	1	<b>373,58</b>
<b>R 922290S</b>	B3	250	200	260	260	520	16	1	<b>382,31</b>
<b>922292S</b>	B3	250	250	305	305	610	12	1	<b>393,24</b>
<b>R 922293S</b>	B3	315	110	305	305	610	8	1	<b>466,87</b>
<b>R 922294S</b>	B3	315	125	305	305	610	8	1	<b>469,51</b>
<b>R 922295S</b>	B3	315	160	305	305	610	6	1	<b>476,14</b>
<b>R 922296S</b>	B3	315	200	305	305	610	6	1	<b>488,61</b>
<b>R 922298S</b>	B3	315	250	305	305	610	6	1	<b>511,17</b>
<b>922299S</b>	B3	315	315	305	305	610	6	1	<b>528,89</b>

R Contattare il Customer Service per tempistiche sulla disponibilita



**Braga ventilata a 88° 1/2**

Codice	Classe	d1=d2	d3	x1	x2	x3	H	Pallet	Conf.	Euro pz.
<b>922280</b>	B3	110	110	170	100	140	270	120	10	<b>41,01</b>

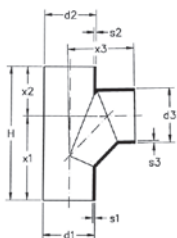

**Braghe doppie 45°**

Codice	Classe	d1=d2	d3	x1	x2	x3	H	Conf.	Euro pz.
<b>922336</b>	B3	90/ 50		80	160	160	240	10	<b>73,55</b>
<b>922343</b>	B3	110/ 50		80	180	180	260	10	<b>69,43</b>
<b>922348</b>	B3	110/110		80	180	180	260	5	<b>69,73</b>

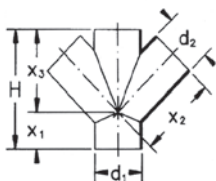

**Braghe a "Y" 30°**

Codice	Classe	d1=d2	d3	x1	x2	Conf.	Euro pz.
* <b>922848</b>	B3	110/110	110	90	120	5	<b>43,48</b>

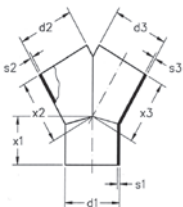

**Braga miscelatrice**

Codice	Classe	Descrizione	Derivazioni	Conf.	Euro pz.
<b>922991</b>	B3	Ø 110	Ø 75	1	<b>238,21</b>

\* Ad esaurimento





**Braghe a sfera a 2 diramazioni Tipo A - 180°**

Codice	Classe	d1/d3-d4	x1	x3-x4	H	Pallet	Conf.	Euro pz.
R <b>922447</b>	B3	110/ 90	100	120	200		5	<b>79,16</b>
<b>922448</b>	B3	110/110	100	120	200		5	<b>80,03</b>

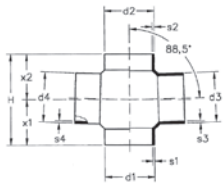
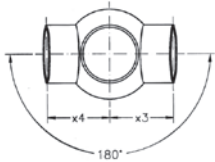

**Braghe a sfera a 2 diramazioni Tipo B - 90°**

Codice	Classe	d1/d3-d4	x1	x3-x4	H	Pallet	Conf.	Euro pz.
* <b>922519</b>	B3	110/ 63	100	120	200		5	<b>103,87</b>
<b>922522</b>	B3	110/110	100	120	200		5	<b>78,47</b>

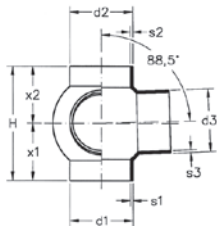
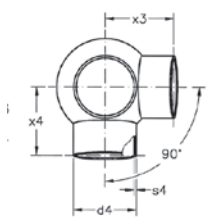

R Contattare il Customer Service per tempistiche sulla disponibilità - \* Ad esaurimento



**Braghe a sfera a 3 diramazioni Tipo E - 90°**

Codice	Classe	d1/d3-d4-d5	x1	x3-x4-x5	H	Pallet	Conf.	Euro pz.
<b>R 922622</b>	B3	110/110	100	120	200		5	<b>101,48</b>

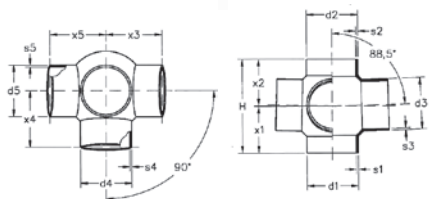

**Braghe a sfera a 4 diramazioni Tipo F - 90°**

Codice	Classe	d1/d3-d4-d5-d6	x1	x3-x4-x5-x6	H	Pallet	Conf.	Euro pz.
<b>* 922721</b>	B3	110/ 90	100	120	200		5	<b>126,03</b>
<b>R 922722</b>	B3	110/110	100	120	200		5	<b>128,38</b>

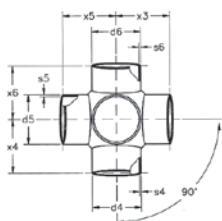

**Ispezioni 45°**

Codice	Classe	d1/d2	x1	x2	x3	H	Pallet	Conf.	Euro pz.
<b>920711</b>	B3	110/110	90	180	230	270		5	<b>102,78</b>
<b>R 920712</b>	B3	125/110	100	200	250	300		5	<b>128,08</b>
<b>920716</b>	B3	160/110	125	250	300	375		5	<b>218,14</b>

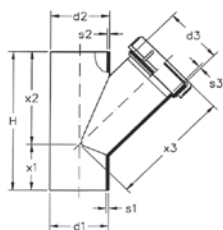

R Contattare il Customer Service per tempistiche sulla disponibilità - \* Ad esaurimento



**Ispezioni 88° 1/2**

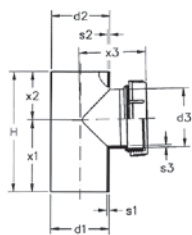

Codice	Classe	d1=d2	d3	x1	x2	x3	H	Conf.	Euro pz.
<b>920865</b>	B3	50	50	90	60	85	150	10	<b>41,14</b>
<b>920867</b>	B3	63	63	105	70	80	175	10	<b>51,63</b>
<b>920868</b>	B3	75	75	105	70	90	175	10	<b>54,27</b>
<b>920869</b>	B3	90	90	120	80	100	200	10	<b>72,84</b>
<b>920870</b>	B3	110	110	135	90	96	225	10	<b>72,84</b>
<b>920871S</b>	B3	125	110	150	100	130	250	10	<b>102,78</b>
<b>920873S</b>	B3	160	110	210	140	150	350	5	<b>191,29</b>
<b>920875S</b>	B3	200	110	180	180	170	360	1	<b>386,45</b>
<b>920877S</b>	B3	250	110	220	220	190	440	1	<b>441,41</b>
<b>920879S</b>	B3	315	110	280	280	210	560	1	<b>560,16</b>



**Manicotti prolungati per WC a pavimento**

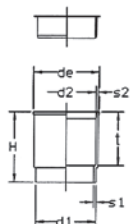

Codice	Classe	d1/de	t	H	Conf.	Euro pz.
<b>923006</b>	B3	90/120	95	125	10	<b>22,00</b>
<b>923016</b>	B3	110/120	95	125	10	<b>21,28</b>



**Curve di allacciamento rasate**

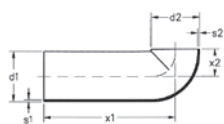

Codice	Classe	d1	x1	x2	Conf.	Euro pz.
<b>921139</b>	B3	90	270	50	15	<b>26,16</b>
<b>921140</b>	B3	110	300	60	10	<b>26,93</b>



**Curve WC tipo "B" prolungate**

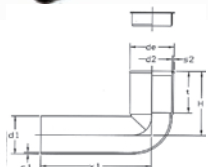

Codice	Classe	d1/de	x1	t	H	Pallet	Conf.	Euro pz.
* <b>923057</b>	B3	90/120	270	120	160	120	10	<b>53,49</b>
<b>923067</b>	B3	110/120	300	120	185	80	10	<b>57,77</b>

\* Con tacca di rientranza



**Curva WC tipo "C" universale**

Codice	Classe	d1/de	x1	t	H	Pallet	Conf.	Euro pz.
<b>923087</b>	B3	110/132	300	120	185	80	10	<b>71,97</b>

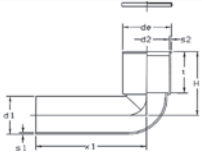

**Curve WC prolungate con attacco sinistro**

Codice	Classe	d1/d2	de	x1	x2	t	H	Pallet	Conf.	Euro pz.
<b>R 926003</b>	B3	90/50	120	270	180	120	160	80	5	<b>92,42</b>

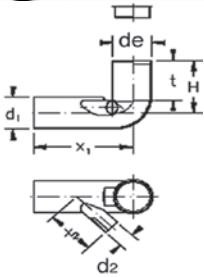

Cod. 926 003 - Ø 90 con tacca di rientranza - Ø 110 con attacchi disassati

**R** Contattare il Customer Service per tempistiche sulla disponibilità



**Curve WC prolungate con 2 attacchi**

Codice	Classe	d1/d2	de	x1	x2	t	H	Pallet	Conf.	Euro pz.
<b>926011</b>	B3	90/50	120	270	180	120	160	80	5	<b>80,24</b>
<b>926013</b>	B3	110/50	120	300	150	140	185	60	5	<b>75,55</b>

Cod. 926 011 e 926 013 - Ø 90 con tacca di rientranza - Ø 110 con attacchi disassati

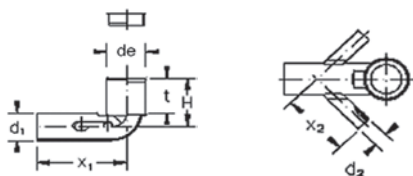

**Manicotti WC scarico parete**

Codice	Classe	d1/di	de	t	H	Conf.	Euro pz.
<b>924227</b>	B3	90/ 90	110	28	38	10	<b>21,32</b>
<b>924228</b>	B3	110/110	131	28	38	10	<b>25,19</b>

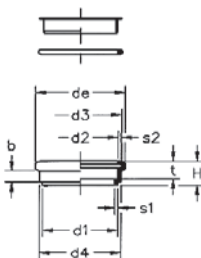

**Curve WC vaso sospeso verticali**

Codice	Classe	d1/di	de	x1	t	H	Pallet	Conf.	Euro pz.
<b>923281</b>	B3	90/ 90	108	225	33	75	160	10	<b>51,23</b>
<b>923280</b>	B3	110/ 90	110	225	33	75	160	10	<b>70,32</b>
<b>923285</b>	B3	110/110	130	300	33	75	120	10	<b>55,44</b>

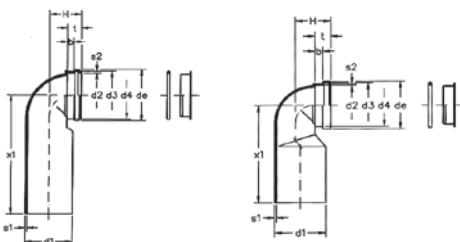



**Curva WC doppia vaso sospeso verticale**

Codice	Classe	d1/di	de	x1	t	H	Pallet	Conf.	Euro pz.
<b>923358</b>	B3	110/110	131	195	28	270	60	5	<b>195,99</b>

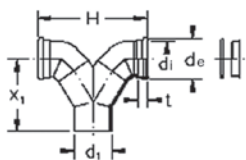

**Sifoni per vaso alla turca - 0° - 45° - 90°**

Codice	Classe	d1	de	x1	α	t	H	Conf.	Euro pz.
<b>923558</b>	B3	90	132	330	45°	60	145	5	<b>106,31</b>
<b>923552</b>	B3	110	132	380	45°	60	165	5	<b>133,35</b>
<b>923555</b>	B3	110	132	330	90°	60	165	5	<b>213,85</b>

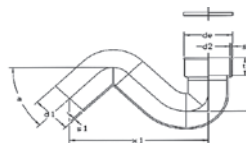

**Sifoni Firenze**

Codice	Classe	d1	x1	H	Pallet	Conf.	Euro pz.
<b>929992</b>	B3	110	580	200		5	<b>233,23</b>

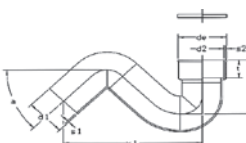

**Manicotti sifone**

Codice	Classe	d1/di	t	H	Conf.	Euro pz.
<b>923606</b>	B3	40/46	25	35	20	<b>6,51</b>
<b>923612</b>	B3	50/46	25	35	20	<b>6,97</b>



di = 46 - morsetti idonei cod. - 308 041 - 308 042 - 308 044

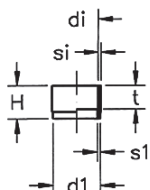



**Curve tecniche**

Codice	Classe	d1/di	x1	t	H	Pallet	Conf.	Euro pz.
<b>923623</b>	B3	32/46	60	20	50	1600	20	<b>18,70</b>
<b>923626</b>	B3	40/46	60	20	50	1920	30	<b>6,05</b>
<b>923632</b>	B3	50/46	60	20	50	1440	30	<b>6,12</b>

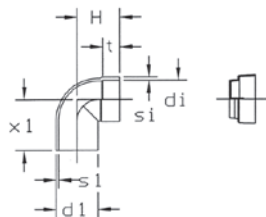

di = 46 - morsetti idonei cod. - 308 041 - 308 042 - 308 044



**Manicotti a saldatura elettrica**

Codice	Classe	d	d1	H	Conf.	Euro pz.
<b>Tipo Universale (WAVIDUO)</b>						
<b>910104</b>	B2	40	54	52	20	<b>13,74</b>
<b>910105</b>	B2	50	64	52	20	<b>15,69</b>
<b>910106</b>	B2	63	77	52	20	<b>21,69</b>
<b>910107</b>	B2	75	90	52	20	<b>25,19</b>
<b>910109</b>	B2	90	104	54	20	<b>27,21</b>
<b>910111</b>	B2	110	124	64	20	<b>30,91</b>
<b>910112</b>	B2	125	143	64	10	<b>38,97</b>
<b>910116</b>	B2	160	180	63	24	<b>74,62</b>

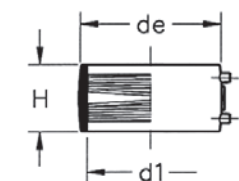

**Tipo Universale (WAVIDUO)**  
diam. 40 - diam. 160

Saldabili con: Saldatrice elettrica tipo Universale cod. 700 020 o saldatrice elettrica Waviduo 315 cod. 711 315, o saldamanicotti TRIAL 315 (cod. 700 033) con cavo giallo (cod. 700 034).



Codice	Classe	d	d1	L	Pallet	Conf.	Euro pz.
<b>Tipo Wavin (WAVIDUO)</b>							
<b>910121</b>	B2	200	226	150	72	6	<b>490,11</b>
<b>910126</b>	B2	250	271,3	150	48	4	<b>615,71</b>
<b>910132</b>	B2	315	343,2	150	36	2	<b>795,09</b>

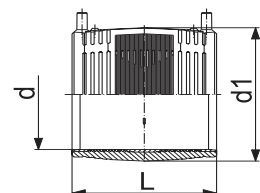

**Tipo Wavin (WAVIDUO)**  
diam. 200 - diam. 315

Saldabili solo con: Saldatrice elettrica Waviduo 315 cod. 711 315 o saldamanicotti TRIAL 315 (cod. 700 033) con cavo nero (cod. 700 035).

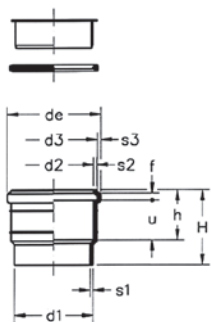

**Manicotti ad innesto**

Codice	Classe	d1	de	h	H	Pallet	Conf.	Euro pz.
<b>924202</b>	B3	32	46,5	35	50	2560	20	<b>10,43</b>
<b>924203</b>	B3	40	57	50,5	85	2560	40	<b>9,63</b>
<b>924205</b>	B3	50	67	50,5	85	1920	40	<b>10,43</b>
<b>924207</b>	B3	63	79	51,5	85	1280	20	<b>16,53</b>
<b>924208</b>	B3	75	92	65,5	100	640	20	<b>20,04</b>
<b>924209</b>	B3	90	110	69	105	480	20	<b>23,53</b>
<b>924210</b>	B3	110	131	71	105	320	20	<b>27,14</b>
<b>924211</b>	B3	125	150	75,5	115	320	10	<b>41,23</b>
<b>924213</b>	B3	160	184	96,5	150	144	18	<b>68,28</b>

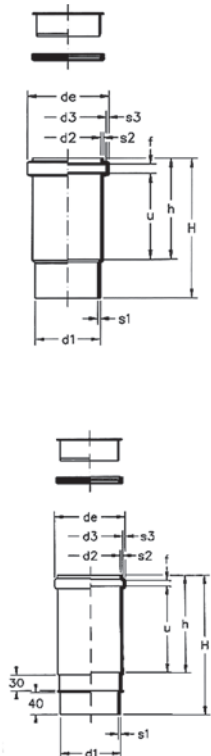

**Manicotti di dilatazione**

**Profondità d'innesto mm**

Ø	-10°	0°	+10°	+20°
<b>40 - 160</b>	70	80	90	105
<b>200-315</b>	170	180	190	205

Manicotto Ø 110 e Ø 160 sono dotati di tacca di fissaggio per collare.

Codice	Classe	d1	de	h	H	Pallet	Conf.	Euro pz.
<b>924103</b>	B3	40	57	170	235	960	20	<b>25,10</b>
<b>924105</b>	B3	50	67	170	235	640	20	<b>25,79</b>
<b>924107</b>	B3	63	80	175	235	480	20	<b>26,75</b>
<b>924108</b>	B3	75	92	179	240	320	20	<b>28,68</b>
<b>924109</b>	B3	90	110	175	240	240	10	<b>30,14</b>
<b>924110</b>	B3	110	130	178	255	160	20	<b>38,99</b>
<b>924111</b>	B3	125	148	180	255	120	10	<b>55,44</b>
<b>924113</b>	B3	160	187,4	190	296	60	5	<b>93,93</b>
<b>924115S</b>	B3	200	228	205	345	30	1	<b>438,50</b>
<b>924117</b>	B3	250	280	250	442	20	1	<b>763,92</b>
<b>924119</b>	B3	315	350	250	452	20	1	<b>1283,80</b>

**Dilatatore Ø 110 mm  
Ø 160 mm**

I manicotti di dilatazione delle dimensioni 40-315 mm sopportano la dilatazione o la contrazione di un tubo lungo 5000 mm.  
10°C differenza di temperatura = 2 mm di dilatazione o contrazione al m.  
Sul manicotto di dilatazione è indicata la profondità d'innesto del tubo ad una temperatura ambientale di 0° C e +20° C.





**Raccordi a vite**

Codice	Classe	d1	de	h	H	Conf.	Euro pz.
<b>924303</b>	B3	40	64	30	50	20	<b>13,39</b>
<b>924306</b>	B3	50	74	34	58	20	<b>16,35</b>
<b>924310</b>	B3	63	87	36	63	10	<b>21,00</b>
<b>924311</b>	B3	75	103	42	65	10	<b>23,58</b>
<b>924313</b>	B3	110	145	57	90	10	<b>43,87</b>

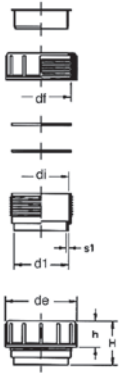

**Colletti di fissaggio**

Codice	Classe	d1	x1	H	Conf.	Euro pz.
<b>924373</b>	B3	110	52	110	10	<b>18,10</b>

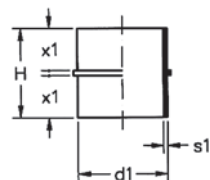

**Cappe di chiusura complete**

Codice	Classe	d1	x1	H	Conf.	Euro pz.
<b>924443</b>	B3	40	64	45	10	<b>11,64</b>
<b>924446</b>	B3	50	74	55	10	<b>17,13</b>
<b>924450</b>	B3	63	87	40	10	<b>20,04</b>
<b>924451</b>	B3	75	103	45	10	<b>25,66</b>
<b>924452</b>	B3	90	123	45	10	<b>38,71</b>
<b>924453</b>	B3	110	145	50	10	<b>41,04</b>

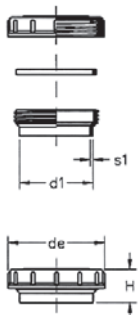



**Tappi a saldare**

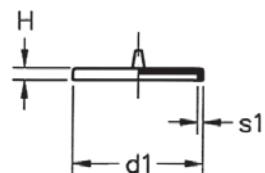

924 622

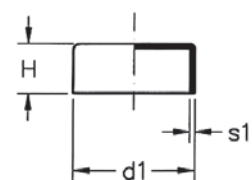

Codice	Classe	d1	H	Conf.	Euro pz.
<b>924622</b>	B3	32 modello corto	5	20	<b>6,05</b>
<b>924623</b>	B3	40	38	20	<b>5,21</b>
<b>924625</b>	B3	50	38	20	<b>5,83</b>
<b>924627</b>	B3	63	38	20	<b>7,97</b>
<b>924628</b>	B3	75	38	20	<b>8,96</b>
<b>924629</b>	B3	90	40	20	<b>10,40</b>
<b>924630</b>	B3	110	45	20	<b>13,00</b>
<b>924631</b>	B3	125	46	10	<b>17,98</b>
<b>924633</b>	B3	160	48	10	<b>54,27</b>



**Tappi di protezione**

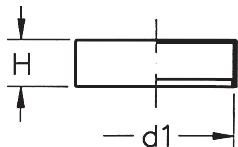

Codice	Classe	d1	H	Conf.	Euro pz.
<b>R 929004</b>	B3	40	30	40	<b>5,69</b>
<b>929005</b>	B3	50	30	40	<b>7,35</b>
<b>929006</b>	B3	63	30	40	<b>6,10</b>
<b>929007</b>	B3	75	30	40	<b>6,65</b>
<b>929009</b>	B3	90	31	50	<b>7,57</b>
<b>929011</b>	B3	110	33	40	<b>7,30</b>
<b>929012</b>	B3	125	36	50	<b>10,27</b>



**Colletti a saldare**

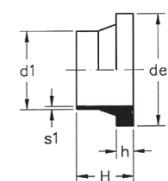

Codice	Classe	dim.	d1	de	h	H	Conf.	Euro pz.
<b>R 926521</b>	B3	DN 40	50	88	17	60	5	<b>115,82</b>
<b>R 926522</b>	B3	DN 50	63	102	19	65	5	<b>118,65</b>
<b>926523</b>	B3	DN 65	75	122	21	70	5	<b>140,63</b>
<b>926524</b>	B3	DN 80	90	138	22	70	5	<b>146,44</b>
<b>926525</b>	B3	DN 100	110	158	24	80	5	<b>152,26</b>
<b>926527</b>	B3	DN 100	125	158	24	80	10	<b>164,30</b>
<b>R 926526</b>	B3	DN 125	125	188	24	80	5	<b>197,65</b>
<b>926528</b>	B3	DN 150	160	212	24	85	5	<b>219,94</b>
<b>926529</b>	B3	DN 200	200	268	24	140	5	<b>667,58</b>
<b>926519</b>	B3	DN 250	250	320	27	145	1	<b>781,21</b>
<b>R 926520</b>	B3	DN 300	315	370	27	145	1	<b>1.095,14</b>

R Contattare il Customer Service per tempistiche sulla disponibilità

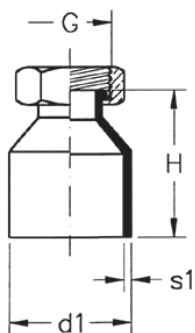

**Raccordi con dado in ottone**

Codice	Classe	d1	G	H	Conf.	Euro pz.
<b>924734</b>	B3	40	3/4"	60	20	<b>25,79</b>
<b>924735</b>	B3	40	1"	60	20	<b>26,75</b>
<b>924736</b>	B3	40	1-1/4"	60	20	<b>22,47</b>
<b>924737</b>	B3	40	1-1/2"	60	20	<b>25,79</b>
<b>924743</b>	B3	50	3/4"	75	20	<b>52,92</b>
<b>924756</b>	B3	50	1-1/4"	60	20	<b>31,44</b>
<b>924757</b>	B3	50	1-1/2"	60	20	<b>33,65</b>
<b>924758</b>	B3	50	2"	60	20	<b>41,93</b>
<b>924760</b>	B3	63	2"	82	10	<b>78,86</b>

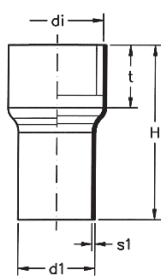

**Manicotti a restringere**

Codice	Classe	d1	di	t	Ø Collegabile	H	Conf.	Euro pz.
<b>925915</b>	B3	50	68	80	45 ÷ 60	250	5	<b>58,95</b>
<b>925917</b>	B3	63	91	85	60 ÷ 82	250	5	<b>72,75</b>
<b>925918</b>	B3	75	100	90	70 ÷ 92	250	5	<b>84,89</b>
<b>925919</b>	B3	90	111	100	85 ÷ 102	250	5	<b>87,23</b>
<b>925920</b>	B3	110	132	90	105 ÷ 124	250	5	<b>92,31</b>
<b>925921</b>	B3	125	156	100	120 ÷ 148	250	5	<b>102,87</b>
<b>925922</b>	B3	160	180	100	155 ÷ 172	250	5	<b>174,81</b>
<b>925916</b>	B3	200	220	100	195 ÷ 212	250	1	<b>494,00</b>

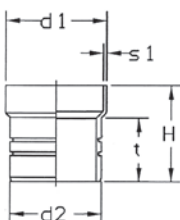

**Allacciamento al PVC**

Codice	Classe	d1/d2	t	H	Conf.	Euro pz.
<b>925925</b>	B3	110/100	75	105	10	<b>35,91</b>





**Saldamanicotti automatica WaviDUO 40-160 v2**

Codice	Classe	Ø	Descrizione	Conf.	Euro pz.
<b>700020</b>	X1	40 - 160	Saldamanicotti	1	<b>1.164,48</b>

Alimentazione 220V-50Hz

**Saldamanicotti Waviduo 315**



Codice	Classe	Ø	Descrizione	Conf.	Euro pz.
<b>711315</b>	X1	40 - 315	Saldamanicotti	1	<b>2.645,17</b>

Alimentazione: 220V

Peso: 1,3 Kg.

Completa di: cavo verde 4A/82 sec. per manicotti Ø 40-160  
 cavo marrone 10A/70 sec. per manicotti Ø 200-315  
 valigetta in metallo

**Saldamanicotti TRIAL 315**

**Attenzione i cavi di saldatura devono essere acquistati separatamente**



Codice	Classe	Descrizione	Conf.	Euro pz.
<b>R 700033</b>	X1	Saldamanicotti Trial 315 composta da macchina e valigetta, cavi di saldatura esclusi	1	<b>2.130,69</b>

**Ricambi**

Codice	Classe	Descrizione	Conf.	Euro pz.
<b>R 700039</b>	X1	Cavo secondario per TRIAL 315	1	<b>275,67</b>

Codice	Classe	Descrizione	Conf.	Euro pz.
<b>R 700034</b>	X1	Cavo per saldatrice Trial 315 WavinDuo 40-160 (giallo)	1	<b>132,13</b>

Codice	Classe	Descrizione	Conf.	Euro pz.
<b>R 700035</b>	X1	Cavo per saldatrice Trial WaviDuo 200-315 (nero)	1	<b>132,13</b>

**R** Contattare il Customer Service per tempistiche sulla disponibilita



**Specchio per saldatura**

Codice	Classe	Desc.	Ø Saldabili	Conf.	Euro pz.
<b>700 016</b>	X1	TP200	max Ø di saldatura 160	1	<b>749,75</b>
<b>R 700 017</b>	X1	TP300	max Ø di saldatura 250	1	<b>1.184,38</b>

- Termostato manuale
- Rivestimento in Teflon
- Completo di forcina
- Valigetta metallica
- Potenza massima assorbita TP200 1200W P300 1300W
- Alimentazione 220 ~ 50 Hz



**Mini 160 JOYT**

Codice	Classe	Ø	Descrizione	Conf.	Euro pz.
<b>R 700055</b>	X1	40 ÷ 160	Saldatrice	1	<b>8.953,52</b>

- Macchina saldatrice completa di:
- termoplastra teflonata
  - fresa piallatrice elettrica
  - serie di ganasce Ø 160 e riduttori per la saldatura dei diametri 40/50/63/75/90/110/125/160



**Universal VR 160 JOYT**

Codice	Classe	Ø	Descrizione	Conf.	Euro pz.
<b>700054</b>	X1	40 ÷ 160	Saldatrice	1	<b>9.300,55</b>

- Macchina saldatrice completa di:
- termoplastra teflonata 220V, 800W, autocentrante
  - fresa intestratrice motorizzata completa di fermo meccanico destro/sinistro
  - movimento carrello con cremagliera e controllo della pressione costante
  - ganasce con possibilità di saldatura universale per braghe a 45° - 60° - 88 1/2°, raccordi, gomiti, tubi Ø 40 - 160



**Media 250**

Codice	Classe	Ø	Descrizione	Conf.	Euro pz.
<b>700002</b>	X1	75 ÷ 250	Saldatrice	1	<b>10.893,72</b>

- Macchina saldatrice completa di:
- fresa piallatrice elettrica con microinterruttore incorporato nell'impugnatura
  - termoplastra teflonata Ø 300 - 220V, 1300W
  - serie di ganasce Ø 250 e riduttori per la saldatura dei diametri 75/90/110/125/160/200

**R** Contattare il Customer Service per tempistiche sulla disponibilità



**Maxi 315**

Codice	Classe	Ø	Descrizione	Conf.	Euro pz.
R <b>700003</b>	X1	125 ÷ 315	Saldatrice	1	<b>20.481,85</b>

Macchina saldatrice completa di:  
 - fresa piattatrice elettrica con microinterruttore incorporato nell'impugnatura  
 - termoplastra teflonata Ø 340 - 220V, 1800W  
 - serie di ganasce e riduttori, per la saldatura dei diametri 315/250/200/160/125  
 - montata su carrello



**Tagliatubi**

Codice	Classe	Descrizione	Conf.	Euro pz.
R <b>577913</b>	X2	Manuale 0/75	1	<b>300,55</b>
<b>577915</b>	X2	Manuale 50/140	1	<b>375,42</b>



**Raschiatori**

Codice	Classe	Descrizione	Conf.	Euro pz.
R <b>574010</b>	X2	Raschiatore PS 75/180	1	<b>1718,15</b>
R <b>574011</b>	X2	Raschiatore RT 75/315	1	<b>3985,96</b>
* <b>574001</b>	X2	Lama Ricambio per Raschiatore RT e PS	1	<b>169,87</b>

Cod. 574 010



Cod. 574 011



**Raschiatore manuale**

Codice	Classe	Descrizione	Conf.	Euro pz.
<b>579030</b>	X2	Raschiatore manuale per tubo	10	<b>24,27</b>

R Contattare il Customer Service per tempistiche sulla disponibilita - \* Ad esaurimento

## Ricambi per i sistemi di scarico Wavin PE

Codice	Classe	Descrizione	Conf.	Euro pz.
* <b>304600</b>	X1	Filo PE per riparazione 1 mt.	1	<b>2,88</b>
<b>R 574012</b>	X2	Porta placchetta per raschiatore RT 75/315 (cod. 574011)	1	<b>128,50</b>
<b>R 577914</b>	X2	Lama di ricambio per Tagliatubi TU 0/75	1	<b>67,35</b>
<b>R 577916</b>	X2	Lama di ricambio per Tagliatubi TU 50/140	1	<b>122,06</b>
<b>R 700100</b>	X1	Cavo ricambio per Saldamancotti Waviduo (cod. 700020)	1	<b>184,32</b>
<b>R 574633</b>	X2	Cavo verde per Saldatrice Universale (cod. 574680) Manicotti elettrici scarico Waviduo 40-160	1	<b>563,86</b>
<b>710001</b>	X1	Cavo di saldatura verde 40-160 per Waviduo 315 (cod. 711 315)	1	<b>357,70</b>
<b>R 710002</b>	X1	Cavo di saldatura marrone 200-315 per Waviduo 315 (cod. 711 315)	1	<b>357,70</b>
<b>R 710003</b>	X1	Cavo di saldatura seriale 40-160 per Waviduo 315 (cod. 711 315)	1	<b>357,70</b>
<b>R 710004</b>	X1	Valigetta di ricambio per Waviduo 315 (cod. 711 315)	1	<b>435,60</b>

**R** Contattare il Customer Service per tempistiche sulla disponibilit  - \* Ad esaurimento





# Wavin ED Tech



ED Tech

**GAMMA**

Wavin ED Tech offre una gamma completa di tubi e raccordi in polipropilene, dal diametro 32 al 160 mm.

Diametro nominale mm	Spessore mm	Lunghezza del bicchiere mm	Serie
32	1,8-2,2	46	16
40	1,8-2,2	48	16
50	1,8-2,2	50	16
75	2,3-2,8	55	16
90	2,8-3,3	65	16
110	3,4-4,0	70	16
125	3,1-3,7	75	20
160	3,9-4,5	83	20

**SPECIFICHE TECNICHE****Struttura del tubo**

Polipropilene triplo strato estremamente robusto anche in condizioni di gelo.

**Metodo di giunzione**

Giunzioni con bicchiere ad innesto, con guarnizioni di tenuta in gomma elastomerica che hanno la stessa durata del tubo, conformi alla normativa EN 681

**Comportamento al fuoco**

Classe D-s2, d1 in accordo alla EN13501-1

**Densità**

≈ 0,91 gr/cm<sup>3</sup> in accordo alla EN ISO 1183-1

**Temperatura di esercizio**

90°C temperatura massima; 95°C per brevi periodi

**Coefficiente di dilatazione**

0,14 mm/m/K

**Resistenza all'urto**

0°C test conformi alla EN744

**Certificato di conformità**

PIIP (n°1749 - 1755 - 1756)

**APPLICAZIONI**

Wavin ED Tech può essere utilizzato sia nel civile che nell'industriale, per condotte adibite allo scarico di apparecchi sanitari, lavatrici, lavastoviglie, scarico prolungato di acqua usata (da grandi cucine o lavanderie); l'impiego è previsto anche nel deflusso delle acque piovane all'interno degli edifici.

**CERTIFICAZIONI**

I componenti del sistema Wavin ED Tech soddisfano i requisiti della norma europea EN1451-1, di applicazione EN12056-2, e di resistenza al fuoco EN13501. L'azienda soddisfa i requisiti di qualità secondo le norme ISO 9001 e requisiti ambientali secondo la norma ISO 14001.

**VANTAGGI DEL SISTEMA****Resistenza agli scarichi delle lavatrici e lavastoviglie**

Alta resistenza alle acque bollenti grazie agli spessori ed al materiale utilizzato.

**Resistenza alle basse temperature**

Grazie alla sua elasticità risulta resistente anche nell'eventualità di gelo.

**Resistenza all'abrasione**

Grazie agli spessori ed alle caratteristiche di compattezza, il Wavin ED Tech resiste a possibili particelle che si trovano all'interno delle tubazioni.

**Mancanza di intasamenti**

Le pareti perfettamente lisce dei tubi e raccordi permettono un deflusso regolare.

**Guarnizioni**

Il materiale elastomerico che le compone garantisce al sistema tenuta e durata anche in condizioni limite.

**Flessibilità**

Il sistema ad innesto con bicchiere agisce come un giunto di dilatazione, caratteristica importante nelle costruzioni in zone sismiche.

**Resistenza all'urto**

Grazie ai tre strati ed all'elevato spessore, la tubazione risulta essere estremamente robusta anche in condizioni di gelo.

## Tubi con bicchiere HTEM

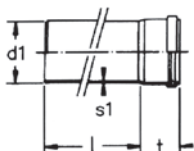

Codice	Classe	d1	L	Pallet	Conf.	Euro pz.
<b>550102</b>	AP	32	250	800	10	<b>4,42</b>
<b>550103</b>	AP	32	500	1440	30	<b>5,75</b>
<b>550105</b>	AP	32	1.000	720	30	<b>8,96</b>
<b>550107</b>	AP	32	1.500	720	30	<b>12,82</b>
<b>550109</b>	AP	32	2.000	720	30	<b>16,16</b>
<b>550111</b>	AP	32	3.000	720	30	<b>25,16</b>
<b>550122</b>	AP	40	250	960	20	<b>3,94</b>
<b>550123</b>	AP	40	500	1200	30	<b>4,73</b>
<b>550125</b>	AP	40	1.000	600	30	<b>7,07</b>
<b>550127</b>	AP	40	1.500	600	30	<b>11,18</b>
<b>550129</b>	AP	40	2.000	600	30	<b>14,05</b>
<b>550131</b>	AP	40	3.000	600	30	<b>21,19</b>
<b>550142</b>	AP	50	250	640	20	<b>4,11</b>
<b>550143</b>	AP	50	500	720	30	<b>5,57</b>
<b>550145</b>	AP	50	1.000	360	30	<b>9,37</b>
<b>550147</b>	AP	50	1.500	360	30	<b>16,16</b>
<b>550149</b>	AP	50	2.000	360	30	<b>18,20</b>
<b>550151</b>	AP	50	3.000	360	30	<b>26,53</b>
<b>550202</b>	AP	75	250	320	20	<b>6,73</b>
<b>550203</b>	AP	75	500	360	20	<b>8,38</b>
<b>550205</b>	AP	75	1.000	180	20	<b>13,80</b>
<b>550207</b>	AP	75	1.500	180	20	<b>23,46</b>
<b>550209</b>	AP	75	2.000	180	20	<b>25,57</b>
<b>550211</b>	AP	75	3.000	180	20	<b>36,84</b>
<b>550222</b>	AP	90	250	240	20	<b>8,79</b>
<b>550223</b>	AP	90	500	240	8	<b>13,40</b>
<b>550225</b>	AP	90	1.000	120	8	<b>24,10</b>
<b>550227</b>	AP	90	1.500	120	8	<b>33,74</b>
<b>550229</b>	AP	90	2.000	120	8	<b>46,36</b>
<b>550231</b>	AP	90	3.000	120	8	<b>70,08</b>
<b>550242</b>	AP	110	250	160	20	<b>9,43</b>
<b>550243</b>	AP	110	500	160	4	<b>14,82</b>
<b>550245</b>	AP	110	1.000	80	4	<b>24,56</b>
<b>550247</b>	AP	110	1.500	80	4	<b>36,45</b>
<b>550249</b>	AP	110	2.000	80	4	<b>49,81</b>
<b>550251</b>	AP	110	3.000	80	4	<b>77,04</b>
<b>555262</b>	AP	125	250	80	10	<b>21,19</b>
<b>555263</b>	AP	125	500	128	4	<b>26,28</b>
<b>555265</b>	AP	125	1.000	64	4	<b>44,40</b>
<b>555267</b>	AP	125	1.500	64	4	<b>63,16</b>
<b>555269</b>	AP	125	2.000	64	4	<b>78,53</b>
<b>555271</b>	AP	125	3.000	64	4	<b>110,44</b>
<b>555283</b>	AP	160	500	72	4	<b>53,18</b>
<b>555285</b>	AP	160	1.000	36	4	<b>76,73</b>
<b>555287</b>	AP	160	1.500	36	4	<b>108,91</b>
<b>555289</b>	AP	160	2.000	36	4	<b>138,75</b>
<b>555291</b>	AP	160	3.000	36	4	<b>201,94</b>



**Tubi con 2 bicchieri HTDM**



Codice	Classe	d1	L	Pallet	Conf.	Euro pz.
<b>550303</b>	AP	32	500	1440	30	<b>8,72</b>
<b>550305</b>	AP	32	1.000	720	30	<b>9,90</b>
<b>550309</b>	AP	32	2.000	720	30	<b>18,61</b>
<b>550311</b>	AP	32	3.000	720	30	<b>24,94</b>
<b>550323</b>	AP	40	500	1200	30	<b>5,67</b>
<b>550325</b>	AP	40	1.000	600	30	<b>8,54</b>
<b>550327</b>	AP	40	1.500	600	30	<b>12,67</b>
<b>550329</b>	AP	40	2.000	600	30	<b>14,98</b>
<b>550331</b>	AP	40	3.000	600	30	<b>22,67</b>
<b>550343</b>	AP	50	500	720	30	<b>7,22</b>
<b>550345</b>	AP	50	1.000	360	30	<b>10,17</b>
<b>550347</b>	AP	50	1.500	360	30	<b>16,54</b>
<b>550349</b>	AP	50	2.000	360	30	<b>19,64</b>
<b>550351</b>	AP	50	3.000	360	30	<b>29,57</b>
<b>550403</b>	AP	75	500	360	20	<b>11,07</b>
<b>550405</b>	AP	75	1.000	180	20	<b>16,37</b>
<b>550407</b>	AP	75	1.500	180	20	<b>24,56</b>
<b>550409</b>	AP	75	2.000	180	20	<b>30,09</b>
<b>550411</b>	AP	75	3.000	180	20	<b>44,54</b>
<b>550423</b>	AP	90	500	240	8	<b>17,92</b>
<b>550425</b>	AP	90	1.000	120	8	<b>26,80</b>
<b>550427</b>	AP	90	1.500	120	8	<b>40,20</b>
<b>550429</b>	AP	90	2.000	120	8	<b>47,79</b>
<b>550431</b>	AP	90	3.000	120	8	<b>75,96</b>
<b>550443</b>	AP	110	500	160	4	<b>18,78</b>
<b>550445</b>	AP	110	1.000	80	4	<b>29,99</b>
<b>550447</b>	AP	110	1.500	80	4	<b>43,01</b>
<b>550449</b>	AP	110	2.000	80	4	<b>51,45</b>
<b>550451</b>	AP	110	3.000	80	4	<b>79,54</b>
<b>555463</b>	AP	125	500	128	4	<b>34,58</b>
<b>555465</b>	AP	125	1.000	64	4	<b>51,06</b>
<b>555467</b>	AP	125	1.500	64	4	<b>70,50</b>
<b>555469</b>	AP	125	2.000	64	4	<b>95,77</b>
<b>555471</b>	AP	125	3.000	64	4	<b>128,43</b>

**Curve 15° HTB**

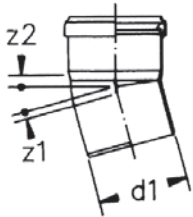

Codice	Classe	d1	z1	z2	Pallet	Conf.	Euro pz.
<b>241221D</b>	A2	32	4	8	2560	20	<b>3,34</b>
<b>241231D</b>	A2	40	5	8	1920	40	<b>2,52</b>
<b>241251D</b>	A2	50	5	9	1280	20	<b>2,99</b>
<b>241281D</b>	A2	75	7	11	640	20	<b>5,62</b>
<b>241291D</b>	A2	90	7	12	480	20	<b>8,46</b>
<b>241301D</b>	A2	110	9	14	240	20	<b>9,50</b>
<b>241311D</b>	A2	125	10	15	160	20	<b>25,95</b>
<b>241321D</b>	A2	160	13	19	80	10	<b>61,44</b>

**Curve 30° HTB**

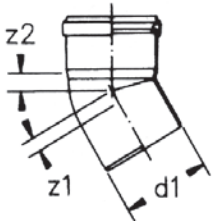

Codice	Classe	d1	z1	z2	Pallet	Conf.	Euro pz.
<b>241223D</b>	A2	32	6	10	2560	20	<b>3,43</b>
<b>241233D</b>	A2	40	7	11	1920	40	<b>2,69</b>
<b>241253D</b>	A2	50	9	12	1280	20	<b>3,11</b>
<b>241283D</b>	A2	75	12	15	640	20	<b>5,85</b>
<b>241293D</b>	A2	90	14	17	320	20	<b>8,96</b>
<b>241303D</b>	A2	110	17	21	240	20	<b>10,04</b>
<b>241313D</b>	A2	125	19	23	160	20	<b>25,95</b>
<b>241323D</b>	A2	160	24	30	80	10	<b>61,44</b>

**Curve 45° HTB**

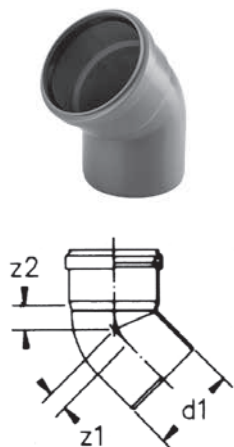

Codice	Classe	d1	z1	z2	Pallet	Conf.	Euro pz.
<b>241224D</b>	A2	32	9	12	3200	40	<b>3,27</b>
<b>241234D</b>	A2	40	10	14	1920	60	<b>2,52</b>
<b>241254D</b>	A2	50	12	16	1280	40	<b>2,99</b>
<b>241284D</b>	A2	75	18	21	480	20	<b>5,54</b>
<b>241294D</b>	A2	90	22	25	320	20	<b>8,54</b>
<b>241304D</b>	A2	110	25	29	240	30	<b>9,50</b>
<b>241314D</b>	A2	125	28	33	160	20	<b>23,60</b>
<b>241324D</b>	A2	160	36	42	80	10	<b>56,39</b>

**Curve 67° 30' HTB**

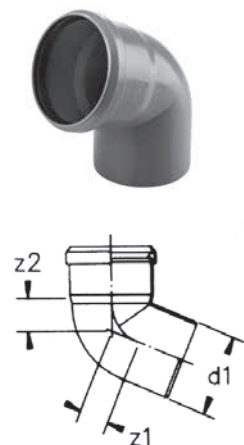

Codice	Classe	d1	z1	z2	Pallet	Conf.	Euro pz.
<b>241226D</b>	A2	32	14	17	2560	20	<b>3,34</b>
<b>241236D</b>	A2	40	16	20	1920	40	<b>2,52</b>
<b>241256D</b>	A2	50	20	23	1280	20	<b>3,11</b>
<b>241286D</b>	A2	75	28	31	480	20	<b>5,70</b>
<b>241296D</b>	A2	90	32	36	320	20	<b>12,66</b>
<b>241306D</b>	A2	110	40	44	160	20	<b>9,72</b>
<b>241316D</b>	A2	125	46	50	120	20	<b>25,44</b>

**Curve 87° 30' HTB**

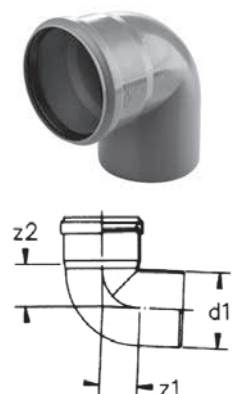

Codice	Classe	d1	z1	z2	Pallet	Conf.	Euro pz.
<b>241228D</b>	A2	32	19	23	3200	40	<b>3,27</b>
<b>241238D</b>	A2	40	23	26	1920	60	<b>2,52</b>
<b>241258D</b>	A2	50	28	31	1280	40	<b>2,99</b>
<b>241288D</b>	A2	75	40	43	480	20	<b>5,54</b>
<b>241298D</b>	A2	90	47	53	320	20	<b>8,54</b>
<b>241308D</b>	A2	110	57	61	160	20	<b>9,50</b>
<b>241318D</b>	A2	125	65	70	120	20	<b>25,13</b>
<b>241328D</b>	A2	160	83	89	60	10	<b>72,40</b>

**Braghe 45° HTEA**

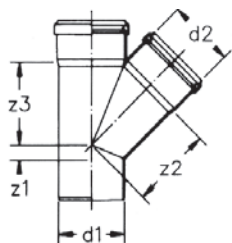

Codice	Classe	d1/d2	z1	z2	z3	Pallet	Conf.	Euro pz.
<b>242005D</b>	A2	32/32	9	39	39	1600	20	<b>6,70</b>
<b>242008D</b>	A2	40/32	5	45	43	1280	20	<b>7,85</b>
<b>242009D</b>	A2	40/40	10	49	49	960	40	<b>4,78</b>
<b>242016D</b>	A2	50/40	5	56	54	640	20	<b>5,45</b>
<b>242018D</b>	A2	50/50	12	61	61	640	20	<b>6,03</b>
<b>242030D</b>	A2	75/40	-7	74	67	480	20	<b>9,58</b>
<b>242031D</b>	A2	75/50	-1	79	74	480	20	<b>9,81</b>
<b>242034D</b>	A2	75/75	18	91	91	320	20	<b>11,21</b>
<b>242035D</b>	A2	90/40	15	85	60	240	15	<b>12,08</b>
<b>242036D</b>	A2	90/50	-6	121	121	240	15	<b>11,21</b>
<b>242038D</b>	A2	90/75	10	108	114	180	15	<b>23,51</b>
<b>242040D</b>	A2	90/90	17	117	117	180	15	<b>16,39</b>
<b>242042D</b>	A2	110/40	-24	99	84	240	20	<b>11,80</b>
<b>242043D</b>	A2	110/50	-17	104	91	240	20	<b>11,80</b>
<b>242046D</b>	A2	110/75	1	116	109	160	20	<b>17,49</b>
<b>242047D</b>	A2	110/90	9	182	179	160	20	<b>38,06</b>
<b>242048D</b>	A2	110/110	25	134	134	120	20	<b>17,82</b>
<b>242055D</b>	A2	125/110	18	144	141	80	10	<b>59,67</b>
<b>242056D</b>	A2	125/125	28	152	152	60	5	<b>75,38</b>
<b>242071D</b>	A2	160/110	1	168	159	40	10	<b>161,48</b>
<b>242072D</b>	A2	160/125	12	176	169	40	10	<b>216,58</b>
<b>242074D</b>	A2	160/160	36	194	194	40	10	<b>257,81</b>

**Braghe 67° 30' HTEA**

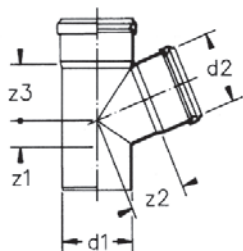

Codice	Classe	d1/d2	z1	z2	z3	Pallet	Conf.	Euro pz.
<b>242109D</b>	A2	40/40	16	33	33	960	20	<b>5,37</b>
<b>242116D</b>	A2	50/40	14	39	35	720	20	<b>8,32</b>
<b>242118D</b>	A2	50/50	20	41	41	720	20	<b>6,28</b>
<b>242142D</b>	A2	110/40	3	71	48	160	20	<b>24,38</b>
<b>242143D</b>	A2	110/50	8	73	54	240	20	<b>13,58</b>
<b>242148D</b>	A2	110/110	40	86	86	120	20	<b>19,33</b>



**Braghe 87° 30' HTEA**

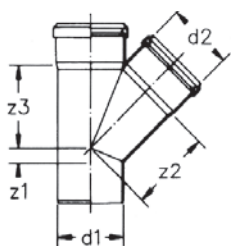

Codice	Classe	d1/d2	z1	z2	z3	Pallet	Conf.	Euro pz.
<b>242205D</b>	A2	32/32	19	21	21	1600	20	<b>7,01</b>
<b>242209D</b>	A2	40/40	23	25	25	960	20	<b>4,92</b>
<b>242216D</b>	A2	50/40	23	30	25	640	20	<b>8,80</b>
<b>242218D</b>	A2	50/50	28	30	30	640	20	<b>6,20</b>
<b>242230D</b>	A2	75/40	22	42	26	480	20	<b>10,54</b>
<b>242231D</b>	A2	75/50	27	43	31	480	20	<b>10,47</b>
<b>242234D</b>	A2	75/75	40	43	43	320	20	<b>11,21</b>
<b>242236D</b>	A2	90/40	23	50,5	27	240	15	<b>16,72</b>
<b>242237D</b>	A2	90/50	28	50	32	240	15	<b>14,43</b>
<b>242240D</b>	A2	90/90	42	57	57	180	15	<b>16,23</b>
<b>242242D</b>	A2	110/40	23	59	27	240	20	<b>13,40</b>
<b>242243D</b>	A2	110/50	28	60	32	240	20	<b>12,14</b>
<b>242246D</b>	A2	110/75	40	60	45	160	20	<b>18,25</b>
<b>242247D</b>	A2	110/90	40	67	51	160	20	<b>37,26</b>
<b>242248D</b>	A2	110/110	57	62	62	160	20	<b>17,82</b>
<b>242255D</b>	A2	125/110	58	69	63	60	10	<b>65,11</b>
<b>242256D</b>	A2	125/125	65	70	70	80	10	<b>87,51</b>
* <b>242271D</b>	A2	160/110	58	86	64	60	10	<b>173,51</b>
<b>242274D</b>	A2	160/160	83	89	89	40	10	<b>264,68</b>



**Braga a scagno 67° 30' HTED**

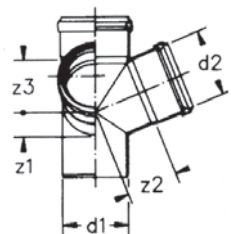

Codice	Classe	d1/d2	z1	z2	z3	Pallet	Conf.	Euro pz.
<b>242522D</b>	A2	110/110	40	86	86	80	10	<b>101,17</b>

\* Ad esaurimento



**Braghe doppie HTDA**

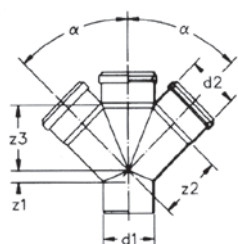

Codice	Classe	d1/d2	$\alpha$	z1	z2	z3	Pallet	Conf.	Euro pz.
<b>242618D</b>	A2	50/50	67° 30'	20	41	41	480	20	<b>34,34</b>
<b>242544D</b>	A2	90/40	45°	15	85	85	240	10	<b>35,19</b>
<b>242545D</b>	A2	90/50	45°	7	90,5	90,5	160	10	<b>37,91</b>
<b>249990D</b>	A2	110/40	45°	-24	99	84	160	20	<b>35,02</b>
<b>242643D</b>	A2	110/50	67° 30'	8	73	54	160	20	<b>37,84</b>
<b>242648D</b>	A2	110/110	67° 30'	40	86	86	80	10	<b>51,67</b>

**Ispezioni HTRE**

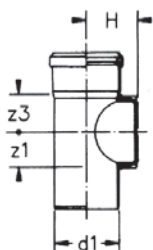

Codice	Classe	d1	z1	z3	H	Pallet	Conf.	Euro pz.
<b>240865D</b>	A2	50	28	30	48	960	20	<b>12,82</b>
<b>240868D</b>	A2	75	40	43	84	480	20	<b>17,46</b>
<b>240869D</b>	A2	90	60	60	90	240	20	<b>29,88</b>
<b>240870D</b>	A2	110	57	62	88	160	20	<b>22,42</b>
<b>240871D</b>	A2	125	65	70	110	90	5	<b>101,04</b>
<b>240873D</b>	A2	160	83	89	110	40	10	<b>155,84</b>

**Manicotti scorrevoli HTU**

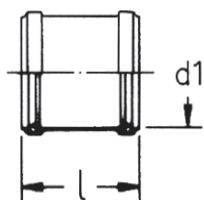

Codice	Classe	d1	L	Pallet	Conf.	Euro pz.
<b>244032D</b>	A2	32	95	2560	20	<b>5,70</b>
<b>244033D</b>	A2	40	107	1600	20	<b>3,91</b>
<b>244035D</b>	A2	50	110	1600	20	<b>4,94</b>
<b>244038D</b>	A2	75	114	640	20	<b>7,35</b>
<b>244039D</b>	A2	90	119	480	20	<b>11,51</b>
<b>244040D</b>	A2	110	130	320	20	<b>11,55</b>
<b>244041D</b>	A2	125	177	160	20	<b>28,79</b>
<b>244043D</b>	A2	160	196	120	15	<b>58,84</b>

**Manicotti con battuta HTMM**

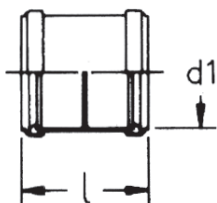

Codice	Classe	d1	L	Pallet	Conf.	Euro pz.
<b>244802D</b>	A2	32	95	2560	20	<b>5,38</b>
<b>244803D</b>	A2	40	107	1600	20	<b>4,43</b>
<b>244805D</b>	A2	50	110	1600	20	<b>5,37</b>
<b>244808D</b>	A2	75	114	640	20	<b>7,35</b>
<b>244809D</b>	A2	90	120	480	20	<b>11,15</b>
<b>244810D</b>	A2	110	130	320	20	<b>12,14</b>
<b>244811D</b>	A2	125	177	180	10	<b>28,89</b>
<b>244812D</b>	A2	160	196	120	15	<b>59,61</b>

**Bicchieri a profondità maggiorata HTLL**

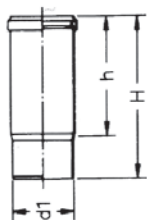

Codice	Classe	d1	h	H	Pallet	Conf.	Euro pz.
<b>244103D</b>	A2	40	175	160	1280	20	<b>8,46</b>
<b>244105D</b>	A2	50	175	160	1280	20	<b>9,03</b>
<b>244108D</b>	A2	75	190	260	480	20	<b>12,81</b>
<b>244109D</b>	A2	90	170	235	320	20	<b>24,70</b>
<b>244110D</b>	A2	110	190	260	160	20	<b>18,09</b>

**Aumenti eccentrici tipo "A" HTR**

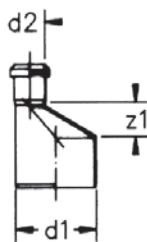

Codice	Classe	d2/d1	z1	Pallet	Conf.	Euro pz.
<b>240718D</b>	A2	32/40	12	2240	20	<b>5,33</b>
<b>240719D</b>	A2	32/50	15	1440	20	<b>5,51</b>
<b>240616D</b>	A2	40/50	12	1600	20	<b>2,93</b>
<b>240630D</b>	A2	40/75	26	960	20	<b>4,94</b>
<b>240631D</b>	A2	50/75	20	960	20	<b>5,62</b>
<b>240643D</b>	A2	50/110	40	480	20	<b>7,96</b>
<b>240646D</b>	A2	75/110	26	480	20	<b>9,12</b>
<b>240647D</b>	A2	90/110	18	320	20	<b>9,81</b>
<b>240655D</b>	A2	110/125	15	320	20	<b>21,84</b>
<b>240671D</b>	A2	110/160	34	160	20	<b>40,76</b>
<b>240672D</b>	A2	125/160	27	160	20	<b>57,41</b>



**Aumenti eccentrici tipo "B" HTR**

Codice	Classe	d2/d1	Pallet	Conf.	Euro pz.
<b>240600D</b>	A2	40/75	1600	20	<b>6,46</b>
<b>240635D</b>	A2	40/90	960	20	<b>9,88</b>
<b>240603D</b>	A2	50/75	1280	20	<b>7,01</b>
<b>240636D</b>	A2	50/90	960	20	<b>7,28</b>
<b>240601D</b>	A2	50/110	640	20	<b>9,12</b>
<b>240602D</b>	A2	75/110	480	20	<b>11,13</b>
<b>240723D</b>	A2	90/110	640	20	<b>11,52</b>

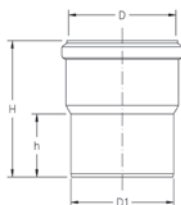

**Riduzione concentrica**

Codice	Classe	D	D1	h	H	Conf.	Euro pz.
<b>240750D</b>	A2	90	75	100	180	5	<b>40,55</b>
<b>240751D</b>	A2	110	90	61,5	133	20	<b>25,71</b>
<b>240752D</b>	A2	125	110	100	180	5	<b>64,53</b>



**Aumenti concentrici**

Codice	Classe	d2/d1	H	Pallet	Conf.	Euro pz.
<b>240708D</b>	A2	32/40	65	5120	40	<b>5,23</b>
<b>240716D</b>	A2	40/50	55	3200	40	<b>5,23</b>
<b>240722D</b>	A2	75/90	75	960	20	<b>14,82</b>
<b>240604D</b>	A2	90/110	81,5	640	20	<b>18,02</b>
<b>240724D</b>	A2	90/100	180	160	5	<b>39,18</b>
<b>240725D</b>	A2	110/125 LUNGO	180	160	5	<b>54,65</b>

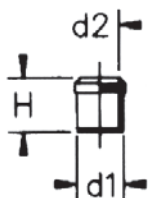



**Tappi aumento**

Codice	Classe	d2/d3/d1	Pallet	Conf.	Euro pz.
<b>240744D</b>	A2	40/40/110	800	10	<b>37,24</b>

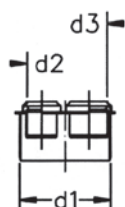

**Riduzioni eccentriche**

Codice	Classe	d2/d1	t	H	Pallet	Conf.	Euro pz.
<b>240721D</b>	A2	40/32	50	95	1600	20	<b>7,96</b>
<b>240720D</b>	A2	50/40	45	105	1600	20	<b>5,85</b>

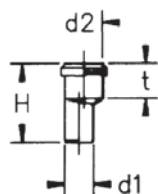

**Curve tecniche HTSW**

Codice	Classe	d1	di	z1	L	h	H	Pallet	Conf.	Euro pz.
<b>243900D</b>	A2	32	46	19	50	26	70	1600	20	<b>5,54</b>
<b>243901D</b>	A2	40	46	24	56	26	79	1920	40	<b>2,85</b>
<b>243902D</b>	A2	50	46	29	61	26	80	1280	20	<b>2,98</b>
<b>243903D</b>	A2	40	53	24	57	26	81	1280	20	<b>5,47</b>
<b>243904D</b>	A2	50	53	29	62	26	82	960	20	<b>4,85</b>
<b>243905D</b>	A2	50	67	29	61	26	90	960	20	<b>6,77</b>

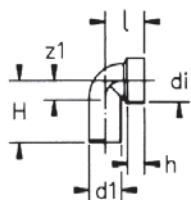

di = 46 - morsetti idonei cod. - **308 041 - 308 042 - 308 044**  
 di = 53 - morsetti idonei cod. **308 046 - 308 048**  
 di = 67 - morsetto idoneo cod. **800 004**



**Curva tecnica prolungata HTSWL**

Codice	Classe	d1	di	z1	L	h	H	Pallet	Conf.	Euro pz.
<b>243907D</b>	A2	40	46	24	56	26	125	1280	40	<b>4,02</b>

di = 46 - morsetti idonei cod. - **308 041 - 308 042 - 308 044**

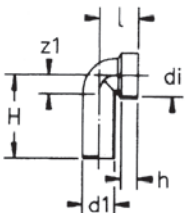

**Manicotti sifone HTS**

Codice	Classe	d1	di	h	H	Pallet	Conf.	Euro pz.
<b>243910D</b>	A2	32	46	26	78		20	<b>6,64</b>
<b>243911D</b>	A2	40	46	26	80		20	<b>2,77</b>
<b>243914D</b>	A2	50	53	26	83		20	<b>9,59</b>

di = 46 - morsetti idonei cod. - **308 041 - 308 042 - 308 044**  
 di = 53 - morsetti idonei cod. **308 046 - 308 048**

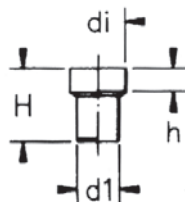

**Curva ridotta HTBR**

Codice	Classe	$\alpha$	d2/d1	h	H	Pallet	Conf.	Euro pz.
<b>241716D</b>	A2	87° 30'	40/50	26	85		20	<b>5,54</b>

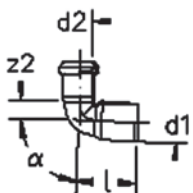

**Curve WC (con guarnizione e tappo) HTSB**

Codice	Classe	d1	l	L	Pallet	Conf.	Euro pz.
<b>243082D</b>	A2	110	100	230		10	<b>30,49</b>

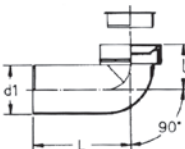



**Curve WC con attacco orientabile (con guarnizione e tappo) HTSB**

Codice	Classe	d1/d2	Conf.	Euro pz.
<b>243109D</b>	A2	110/50	10	<b>45,11</b>

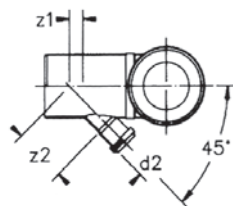

**Curve WC prolungate (con guarnizione e tappo) HTSBL**



Codice	Classe	d1/d2	l	L	Pallet	Conf.	Euro pz.
<b>243086D</b>	A2	90	170	106	160	20	<b>25,62</b>
<b>243087D</b>	A2	110	185	230	120	10	<b>28,13</b>

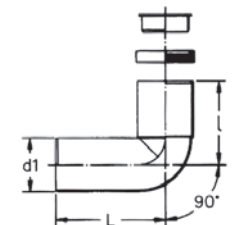

**Curve WC prolungate con attacco orientabile (con guarnizione e tappo) HTSBL**



Codice	Classe	d1/d2	Pallet	Conf.	Euro pz.
<b>243113D</b>	A2	90/40	120	10	<b>42,01</b>
<b>243114D</b>	A2	90/50	120	10	<b>44,10</b>
<b>243118D</b>	A2	110/40	120	10	<b>42,62</b>
<b>243119D</b>	A2	110/50	120	10	<b>43,45</b>

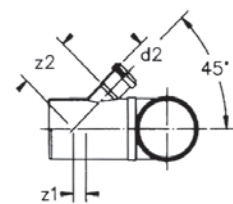



**Curve WC prolungate con 2 attacchi (con guarnizione e tappo) HTSBL**

Codice	Classe	d1/d2	Pallet	Conf.	Euro pz.
<b>243111D</b>	A2	90/40	80	10	<b>59,61</b>
<b>243112D</b>	A2	90/50	80	10	<b>62,77</b>
<b>243115D</b>	A2	110/40	80	10	<b>57,02</b>
<b>243116D</b>	A2	110/50	80	10	<b>58,26</b>

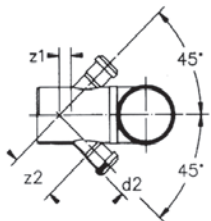

**Curva WC prolungata con 4 attacchi ø 40 (con guarnizione e tappo) HTSBL**

Codice	Classe	d1/d2	i	z1	z2	Pallet	Conf.	Euro pz.
<b>243107D</b>	A2	110/40	185	-24	95	60	5	<b>65,54</b>

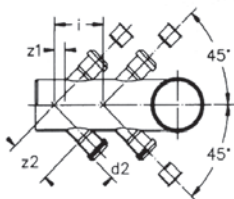

**Sifoni Firenze**

Codice	Classe	d1	L	H	Pallet	Conf.	Euro pz.
<b>240948D</b>	A2	110	540	175	40	5	<b>109,08</b>
<b>240956D</b>	A2	125	600	220	30	5	<b>248,36</b>

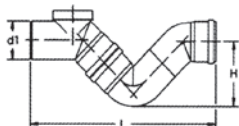



**Curve 87°30' con attacco sinistro HTB**

Codice	Classe	d1/d2	$\alpha$	L	Pallet	Conf.	Euro p.z.
<b>243155D</b>	A2	110/40	45°	120		5	<b>30,21</b>
<b>243160D</b>	A2	110/50	45°	120		5	<b>32,39</b>

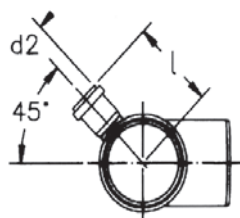

**Curve 87°30' con attacco destro HTB**

Codice	Classe	d1/d2	$\alpha$	L	Pallet	Conf.	Euro p.z.
<b>243165D</b>	A2	110/40	45°	120		5	<b>30,21</b>
<b>243170D</b>	A2	110/50	45°	120		5	<b>32,39</b>

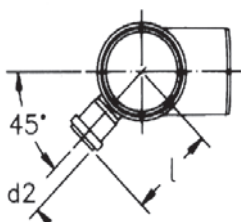

**Curve 87°30' con 2 attacchi HTB**

Codice	Classe	d1/d2	$\alpha$	L	Pallet	Conf.	Euro p.z.
<b>243175D</b>	A2	110/40	45°	120		5	<b>43,10</b>
<b>243180D</b>	A2	110/50	45°	120		5	<b>45,29</b>

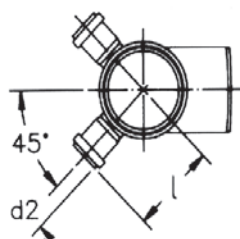



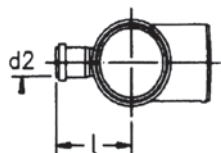

**Curve 87°30' con attacco frontale HTB**

Codice	Classe	d1/d2	L	Pallet	Conf.	Euro pz.
<b>243181D</b>	A2	110/40	120		5	<b>34,25</b>
<b>243182D</b>	A2	110/50	120		5	<b>34,25</b>

**Tappi di chiusura HTM**



Codice	Classe	d1	Pallet	Conf.	Euro pz.
<b>244543D</b>	A2	40	6400	20	<b>2,19</b>
<b>244546D</b>	A2	50	4800	20	<b>2,09</b>
<b>244551D</b>	A2	75	2560	20	<b>4,08</b>
<b>244552D</b>	A2	90	1600	20	<b>7,47</b>
<b>244553D</b>	A2	110	960	20	<b>6,20</b>
<b>244554D</b>	A2	125	960	20	<b>13,48</b>
<b>244555D</b>	A2	160	400	20	<b>33,47</b>

**Accessori**

Consultare l'apposito capitolo "ACCESSORI PER LO SCARICO" per i seguenti articoli:

- Morsetti per curve tecniche e manicotti sifone
- Bracciali di fissaggio per tubi
- Raccordi di passaggio al PVC
- Scivolante

**Ricambi WAVIN ED TECH**

Codice	Classe	Descrizione	Conf.	Euro pz.
<b>800013</b>	W1	Guarnizione a labbro 32	40	<b>0,74</b>
<b>800014</b>	W1	Guarnizione a labbro 40	33	<b>0,74</b>
<b>800015</b>	W1	Guarnizione a labbro 50	35	<b>0,74</b>
<b>800010</b>	W1	Guarnizione a labbro 63	50	<b>1,35</b>
<b>800016</b>	W1	Guarnizione a labbro 75	34	<b>1,00</b>
<b>800011</b>	W1	Guarnizione a labbro 90	32	<b>0,93</b>
<b>800017</b>	W1	Guarnizione a labbro 110	45	<b>1,14</b>
<b>800018</b>	W1	Guarnizione a labbro 125	40	<b>1,72</b>
<b>800019</b>	W1	Guarnizione a labbro 160	34	<b>1,73</b>



# Wavin SiTech+



SiTech+

**GAMMA**

Wavin Sitech+ offre una gamma completa di tubi e raccordi in polipropilene rinforzato con cariche minerali, dal diametro 32 al 160 mm.

Diametro mm	Spessore mm	Lunghezza bicchiere mm	Classe Serie
32	1,8-2,2	43	S16
40	1,8-2,2	45	S16
50	1,8-2,2	47	S16
75	2,6-3,1	53	S14
90	3,1-3,7	57	S14
110	3,4-4,0	64	S16
125	3,9-4,5	71	S16
160	4,9-5,6	76	S16

**SPECIFICHE TECNICHE****Struttura del tubo**

Tubazione co-estrusa a tre strati differenziati. Polipropilene rinforzato con cariche minerali per una maggiore robustezza e durabilità, resistente anche alle basse temperature.

**Metodo di giunzione**

Giunzioni con bicchiere ad innesto, garantite da una guarnizione elastomerica in SBR, per un'installazione veloce, sicura ed affidabile.

**Comportamento al fuoco**

Classe C-s2, d0 in accordo alla EN13501-1.

**Densità**

Tubo 1,30 gr/cm<sup>3</sup>; Raccordo 1,50 gr/cm<sup>3</sup>.

**Temperatura di esercizio**

90°C temperatura massima; 95°C per brevi periodi.

**Coefficiente di dilatazione**

≈ 0,12 mm/m/K.

**Resistenza all'urto**

-20°C test conformi alla EN744.

**Resistenza anulare**

≥ 5.5 (rif.110) Kn/m<sup>2</sup>.

**Certificato di conformità**

PIIP (n°1866 - 1867 - 1868)

DIBT (n° Z-42.1-539)

ITB (n° AT-15-7703).

**Livello acustico (report n° P-BA 24\_1/2016)**

12 dB(A) Rif. 2.0 l/s (in accordo alla nuova procedura di test del Fraunhofer Institute, valida da Gennaio 2014)

**APPLICAZIONI**

Wavin Sitech+ è la soluzione ideale per l'installazione sia in ambienti sensibili al rumore come alberghi, uffici, ospedali, che in edifici residenziali. Grazie all'arricchimento con cariche minerali può essere installato a basse temperature fino a -20°C, idoneo quindi per climi rigidi.

**CERTIFICAZIONI**

I componenti del sistema Wavin Sitech+ soddisfano i requisiti della norma europea EN1451-1, di applicazione EN12056-2, resistenza al fuoco EN13501, e di protezione al rumore secondo la normativa italiana D.P.C.M. 05.12.1997. Il livello di rumorosità è stato misurato all'Istituto Fraunhofer di Stoccarda secondo la normativa EN14366. L'azienda soddisfa i requisiti di qualità secondo le norme ISO 9001 e requisiti ambientali secondo la norma ISO 14001.

**VANTAGGI DEL SISTEMA****Più peso – Meno Rumore**

Raccordi più pesanti del 20% rispetto al vecchio sistema, grazie alla nuova formula della materia prima. Di conseguenza ottime prestazioni acustiche.

**Facilità di installazione**

Gli anelli di rinforzo garantiscono una presa migliore ed una resistenza maggiore.

Tubazioni con marcatura centimetrata per facilitare le operazioni di taglio.

**Indicatore di allineamento**

Indicatori angolari con intervalli a 15° e 45° sui raccordi per facilitare l'allineamento e quindi velocizzare l'installazione.

**Anello di battuta**

Indicatore nei raccordi per garantire il corretto inserimento del bicchiere, utile anche nel caso della misurazione di 10mm necessaria alla compensazione della dilatazione termica.

**Colore nero**

Oltre ad aggiungere robustezza al sistema, consente lo stoccaggio all'esterno proteggendo il prodotto dai raggi UV e dona al prodotto un aspetto più professionale.

**Tubi con bicchiere STEM**

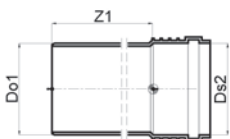

Codice	Classe	Do1=Ds2	Z1	Pallet	Conf.	Euro pz.
<b>260102</b>	CB	32	250	1280	10	<b>4,08</b>
<b>260103</b>	CB	32	500	1440	30	<b>5,62</b>
<b>260105</b>	CB	32	1.000	720	30	<b>8,46</b>
<b>260107</b>	CB	32	1.500	720	30	<b>13,58</b>
<b>260109</b>	CB	32	2.000	720	30	<b>15,90</b>
<b>260122</b>	CB	40	250	960	20	<b>3,77</b>
<b>260123</b>	CB	40	500	1200	30	<b>5,38</b>
<b>260125</b>	CB	40	1.000	600	30	<b>8,25</b>
<b>260127</b>	CB	40	1.500	600	30	<b>13,58</b>
<b>260129</b>	CB	40	2.000	600	30	<b>15,81</b>
<b>260141</b>	CB	50	150	960	20	<b>3,62</b>
<b>260142</b>	CB	50	250	640	20	<b>4,22</b>
<b>260143</b>	CB	50	500	720	30	<b>5,87</b>
<b>260145</b>	CB	50	1.000	360	30	<b>8,59</b>
<b>260147</b>	CB	50	1.500	360	30	<b>14,09</b>
<b>260149</b>	CB	50	2.000	360	30	<b>17,71</b>
<b>260151</b>	CB	50	3.000	360	30	<b>27,67</b>
<b>260201</b>	CB	75	150	480	20	<b>6,62</b>
<b>260202</b>	CB	75	250	320	20	<b>7,67</b>
<b>260203</b>	CB	75	500	360	20	<b>10,05</b>
<b>260205</b>	CB	75	1.000	180	20	<b>14,14</b>
<b>260207</b>	CB	75	1.500	180	20	<b>20,97</b>
<b>260209</b>	CB	75	2.000	180	20	<b>26,20</b>
<b>260211</b>	CB	75	3.000	180	20	<b>39,09</b>
<b>260221</b>	CB	90	150	320	20	<b>7,59</b>
<b>260222</b>	CB	90	250	240	20	<b>9,18</b>
<b>260223</b>	CB	90	500	240	8	<b>13,49</b>
<b>260225</b>	CB	90	1.000	120	8	<b>21,20</b>
<b>260227</b>	CB	90	1.500	120	8	<b>31,98</b>
<b>260229</b>	CB	90	2.000	120	8	<b>40,30</b>
<b>260231</b>	CB	90	3.000	120	8	<b>57,48</b>
<b>260241</b>	CB	110	150	320	20	<b>9,47</b>
<b>260242</b>	CB	110	250	160	20	<b>9,90</b>
<b>260243</b>	CB	110	500	160	4	<b>15,13</b>
<b>260245</b>	CB	110	1.000	80	4	<b>23,63</b>
<b>260247</b>	CB	110	1.500	80	4	<b>33,68</b>
<b>260249</b>	CB	110	2.000	80	4	<b>43,90</b>
<b>260251</b>	CB	110	3.000	80	4	<b>62,79</b>
<b>265262</b>	CB	125	250	80	10	<b>15,82</b>
<b>265263</b>	CB	125	500	128	4	<b>23,63</b>
<b>265265</b>	CB	125	1.000	64	4	<b>34,46</b>
<b>265267</b>	CB	125	1.500	64	4	<b>50,21</b>
<b>265269</b>	CB	125	2.000	64	4	<b>63,29</b>
<b>265271</b>	CB	125	3.000	64	4	<b>90,17</b>

STTech+

**Tubi con bicchiere STEM**

Codice	Classe	Do1=Ds2	Z1	Pallet	Conf.	Euro pz.
<b>265282</b>	CB	160	250	60	5	<b>27,39</b>
<b>265283</b>	CB	160	500	72	4	<b>45,31</b>
<b>265285</b>	CB	160	1.000	36	4	<b>58,93</b>
<b>265289</b>	CB	160	2.000	36	4	<b>97,93</b>
<b>265291</b>	CB	160	3.000	36	4	<b>152,89</b>



**Tubi con 2 bicchieri STDM**

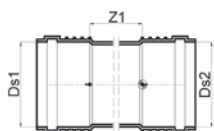

Codice	Classe	Ds1=Ds2	Z1	Pallet	Conf.	Euro pz.
<b>260303</b>	CB	32	500	1440	30	<b>8,55</b>
<b>260305</b>	CB	32	1.000	720	30	<b>10,02</b>
<b>260309</b>	CB	32	2.000	720	30	<b>18,52</b>
<b>260311</b>	CB	32	3.000	720	30	<b>24,83</b>
<b>260323</b>	CB	40	500	1200	30	<b>7,06</b>
<b>260325</b>	CB	40	1.000	600	30	<b>9,92</b>
<b>260327</b>	CB	40	1.500	600	30	<b>16,12</b>
<b>260329</b>	CB	40	2.000	600	30	<b>17,61</b>
<b>260331</b>	CB	40	3.000	600	30	<b>26,82</b>
<b>260343</b>	CB	50	500	720	30	<b>7,74</b>
<b>260345</b>	CB	50	1.000	360	30	<b>9,81</b>
<b>260347</b>	CB	50	1.500	360	30	<b>15,36</b>
<b>260349</b>	CB	50	2.000	360	30	<b>19,94</b>
<b>260351</b>	CB	50	3.000	360	30	<b>30,40</b>
<b>260403</b>	CB	75	500	360	20	<b>13,47</b>
<b>260405</b>	CB	75	1.000	180	20	<b>17,36</b>
<b>260407</b>	CB	75	1.500	180	20	<b>22,53</b>
<b>260409</b>	CB	75	2.000	180	20	<b>31,45</b>
<b>260411</b>	CB	75	3.000	180	20	<b>47,10</b>
<b>260423</b>	CB	90	500	240	8	<b>16,25</b>
<b>260425</b>	CB	90	1.000	120	8	<b>24,91</b>
<b>260427</b>	CB	90	1.500	120	8	<b>35,87</b>
<b>260429</b>	CB	90	2.000	120	8	<b>42,80</b>
<b>260431</b>	CB	90	3.000	120	8	<b>64,20</b>
<b>260443</b>	CB	110	500	160	4	<b>19,43</b>
<b>260445</b>	CB	110	1.000	80	4	<b>28,78</b>
<b>260447</b>	CB	110	1.500	80	4	<b>39,51</b>
<b>260449</b>	CB	110	2.000	80	4	<b>46,57</b>
<b>260451</b>	CB	110	3.000	80	4	<b>69,85</b>
<b>265463</b>	CB	125	500	128	4	<b>28,23</b>
<b>265465</b>	CB	125	1.000	64	4	<b>41,30</b>
<b>265469</b>	CB	125	2.000	64	4	<b>77,46</b>

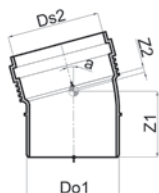

**Curve 15° STB**

Codice	Classe	Do1=Ds2	Z1	Z2	Pallet	Conf.	Euro pz.
<b>261221</b>	CC	32	49	8	2560	20	<b>3,26</b>
<b>261231</b>	CC	40	52	8	1600	20	<b>3,22</b>
<b>261251</b>	CC	50	55	9	1280	20	<b>4,56</b>
<b>261281</b>	CC	75	63	13	480	20	<b>7,05</b>
<b>261291</b>	CC	90	69	15	320	20	<b>9,60</b>
<b>261301</b>	CC	110	79	16	240	20	<b>10,61</b>
<b>261311</b>	CC	125	88	20	160	20	<b>20,61</b>
<b>261321</b>	CC	160	97	25	80	10	<b>33,16</b>

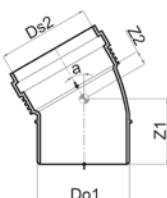

**Curve 30° STB**

Codice	Classe	Do1=Ds2	Z1	Z2	Pallet	Conf.	Euro pz.
<b>261223</b>	CC	32	51	10	2560	20	<b>3,26</b>
<b>261233</b>	CC	40	55	11	1600	20	<b>3,22</b>
<b>261253</b>	CC	50	58	13	1280	20	<b>4,14</b>
<b>261283</b>	CC	75	68	18	480	20	<b>7,05</b>
<b>261293</b>	CC	90	76	22	320	20	<b>9,60</b>
<b>261303</b>	CC	110	88	24	240	20	<b>10,52</b>
<b>261313</b>	CC	125	96	29	160	20	<b>20,29</b>
<b>261323</b>	CC	160	109	36	80	10	<b>33,16</b>

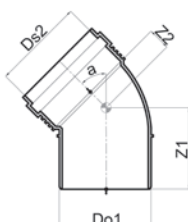

**Curve 45° STB**

Codice	Classe	Do1=Ds2	Z1	Z2	Pallet	Conf.	Euro pz.
<b>261224</b>	CC	32	54	13	2560	20	<b>3,26</b>
<b>261234</b>	CC	40	56	15	1600	20	<b>3,11</b>
<b>261254</b>	CC	50	65	17	1280	20	<b>4,00</b>
<b>261284</b>	CC	75	75	22	480	20	<b>6,97</b>
<b>261294</b>	CC	90	85	26	320	20	<b>9,52</b>
<b>261304</b>	CC	110	96	33	240	20	<b>9,92</b>
<b>261314</b>	CC	125	105	38	160	20	<b>20,44</b>
<b>261324</b>	CC	160	121	48	80	10	<b>32,21</b>

**Curve 67,5° STB**

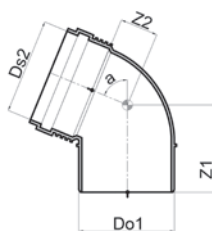

Codice	Classe	Do1=Ds2	Z1	Z2	Pallet	Conf.	Euro pz.
<b>261226</b>	CC	32	58	17	2560	20	<b>3,64</b>
<b>261236</b>	CC	40	63	20	1600	20	<b>3,56</b>
<b>261256</b>	CC	50	70	21	960	20	<b>5,66</b>
<b>261286</b>	CC	75	84	34	480	20	<b>9,25</b>
<b>261296</b>	CC	90	95	41	320	20	<b>10,82</b>
<b>261306</b>	CC	110	108	47	160	20	<b>11,43</b>
<b>261316</b>	CC	125	123	55	160	20	<b>29,91</b>

**Curve 87,5° STB**

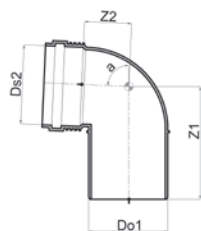

Codice	Classe	Do1=Ds2	Z1	Z2	Pallet	Conf.	Euro pz.
<b>261228</b>	CC	32	62	21	2560	20	<b>3,37</b>
<b>261238</b>	CC	40	68	26	1600	20	<b>3,28</b>
<b>261258</b>	CC	50	78	31	960	20	<b>4,41</b>
<b>261288</b>	CC	75	95	45	320	20	<b>9,08</b>
<b>261298</b>	CC	90	108	54	320	20	<b>10,10</b>
<b>261308</b>	CC	110	128	64	160	20	<b>10,61</b>
<b>261318</b>	CC	125	141	74	120	20	<b>30,11</b>
<b>261328</b>	CC	160	166	94	60	10	<b>49,20</b>





**Braghe 45° semplici e ridotte STEA**

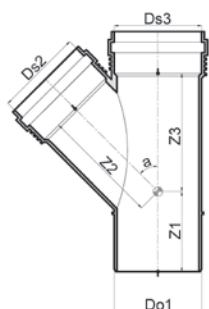

Codice	Classe	Do1=Ds3/Ds2	Z1	Z2	Z3	Pallet	Conf.	Euro pz.
<b>262005</b>	CC	32/32	54	42	42	1280	10	<b>7,16</b>
<b>262008</b>	CC	40/32	58	81	52	800	10	<b>7,83</b>
<b>262009</b>	CC	40/40	58	52	52	800	10	<b>7,39</b>
<b>262016</b>	CC	50/40	55	59	57	640	10	<b>9,08</b>
<b>262018</b>	CC	50/50	64	71	71	640	10	<b>8,81</b>
<b>262031</b>	CC	75/50	56	82	77	320	10	<b>12,44</b>
<b>262034</b>	CC	75/75	74	96	96	240	10	<b>12,31</b>
<b>262035</b>	CC	90/40	46	95	86	240	10	<b>20,78</b>
<b>262036</b>	CC	90/50	56	106	96	240	10	<b>18,83</b>
<b>262038</b>	CC	90/75	77	141	121	160	10	<b>20,81</b>
<b>262040</b>	CC	90/90	83	115	115	160	10	<b>19,04</b>
<b>262042</b>	CC	110/40	52	95	85	160	10	<b>24,22</b>
<b>262043</b>	CC	110/50	63	105	93	160	10	<b>20,67</b>
<b>262046</b>	CC	110/75	71	122	113	120	10	<b>21,13</b>
<b>262047</b>	CC	110/90	82	129	124	80	10	<b>21,13</b>
<b>262048</b>	CC	110/110	108	138	138	80	10	<b>20,86</b>
<b>262053</b>	CC	125/75	70	133	121	80	10	<b>37,40</b>
<b>262055</b>	CC	125/110	95	149	146	80	10	<b>48,63</b>
<b>262056</b>	CC	125/125	106	156	156	60	10	<b>73,91</b>
<b>262071</b>	CC	160/110	82	175	164	40	5	<b>76,32</b>
<b>262074</b>	CC	160/160	120	200	200	30	5	<b>114,58</b>



**Braghe 67,5° semplici e ridotte STEA**

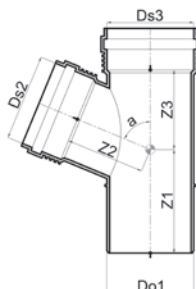

Codice	Classe	Do1=Ds3/Ds2	Z1	Z2	Z3	Pallet	Conf.	Euro pz.
<b>262140</b>	CC	90/90	94	70	70	160	10	<b>20,45</b>
<b>262148</b>	CC	110/110	110	87	87	80	10	<b>21,37</b>

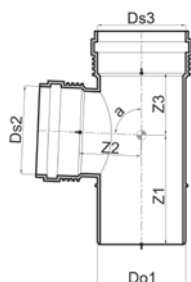

**Braghe 87,5° semplici e ridotte STEA**

Codice	Classe	Do1=Ds3/Ds2	Z1	Z2	Z3	Pallet	Conf.	Euro pz.
<b>262209</b>	CC	40/40	69	28	28	800	10	<b>7,67</b>
<b>262216</b>	CC	50/40	71	33	28	800	10	<b>9,16</b>
<b>262218</b>	CC	50/50	82	35	36	640	10	<b>9,17</b>
<b>262231</b>	CC	75/50	82	45	35	320	10	<b>12,31</b>
<b>262234</b>	CC	75/75	95	49	49	320	10	<b>12,31</b>
<b>262237</b>	CC	90/50	87	53	36	240	10	<b>19,12</b>
<b>262243</b>	CC	110/50	96	63	37	160	10	<b>20,86</b>
<b>262246</b>	CC	110/75	135	66	52	120	10	<b>21,37</b>
<b>262255</b>	CC	125/110	133	77	71	80	10	<b>48,69</b>
<b>262256</b>	CC	125/125	141	80	79	80	10	<b>74,24</b>
<b>262271</b>	CC	160/110	165	103	103	40	5	<b>78,00</b>
<b>262274</b>	CC	160/160	165	111	101	40	5	<b>115,74</b>

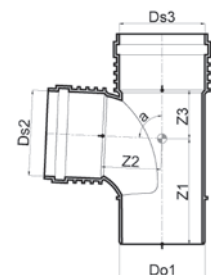

**Braghe a flusso avviato 87,5° semplici e ridotte STEA**

Codice	Classe	Do1=Ds3/Ds2	Z1	Z2	Z3	Pallet	Conf.	Euro pz.
<b>262240</b>	CC	90/90	126	74	52	160	10	<b>18,99</b>
<b>262247</b>	CC	110/90	137	86	53	80	10	<b>22,05</b>
<b>262248</b>	CC	110/110	144	143	64	120	10	<b>20,86</b>

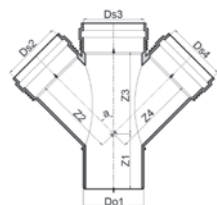

**Braghe doppie STDA**

Codice	Classe	Do1=Ds3 Ds2=Ds4	$\alpha$	Z1	Z2	Z3	Pallet	Conf.	Euro pz.
<b>262641</b>	CC	75/50	87,5°	80	45	35	320	10	<b>66,01</b>
<b>262642</b>	CC	90/50	45°	56	106	96	160	10	<b>54,81</b>
<b>262643</b>	CC	110/50	45°	96	63	37	120	10	<b>52,32</b>

**Braga doppia a flusso avviato 87,5° STDA**



Codice	Classe	Do1=Ds3/ Ds2=Ds4	Z1	Z2	Z3	Pallet	Conf.	Euro pz.
<b>262648</b>	CC	110/110	144	143	64	60	10	<b>41,74</b>

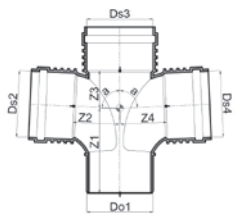

**Braga a scagno 87,5°**



Codice	Classe	Do1=Ds3/ Ds2=Ds4	Z1	Z2	Z3	Pallet	Conf.	Euro pz.
<b>262521</b>	CC	110/50	96	63	37	160	10	<b>53,99</b>

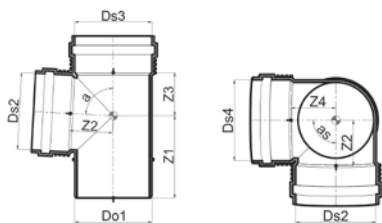

**Braga doppia con attacco doccia 87,5°**



Codice	Classe	Do1=Ds3=Ds4/Ds2	Z	Z1	Z2	Z3	Z4	Pallet	Conf.	Euro pz.
<b>262742</b>	CC	90/50	91	96	53	74	52	160	10	<b>69,21</b>
<b>262743</b>	CC	110/50	111	96	63	79	64	80	10	<b>77,36</b>

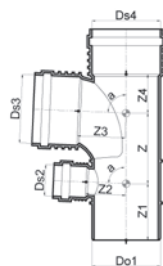



**Ispezioni con tappo a vite STRE**

Codice	Classe	Do1=Ds2	Z1	Z2	H	K	KDe	Pallet.	Conf.	Euro pz.
<b>260865</b>	CC	50/50	83	36	80	65	50	800	10	<b>17,02</b>
<b>260868</b>	CC	75/75	102	50	111	93	75	320	10	<b>20,79</b>
<b>260869</b>	CC	90/90	118	60	132	110	90	160	10	<b>27,87</b>
<b>260870</b>	CC	110/110	135	72	155	128	110	120	10	<b>30,46</b>
<b>260871</b>	CC	125/125	142	74	162	146	110	80	10	<b>63,54</b>
<b>260873</b>	CC	160/160	200	121	236	141	110	40	5	<b>97,77</b>

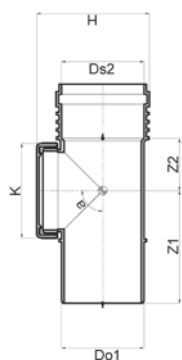

**Manicotti scorrevoli STU**



Codice	Classe	Ds1=Ds2	Pallet.	Conf.	Euro pz.
<b>264 033</b>	CC	40	1600	10	<b>4,85</b>
<b>264 035</b>	CC	50	1280	10	<b>5,30</b>
<b>264 038</b>	CC	75	480	10	<b>7,19</b>
<b>264 039</b>	CC	90	320	10	<b>11,00</b>
<b>264 040</b>	CC	110	240	10	<b>11,80</b>
<b>264 041</b>	CC	125	160	20	<b>22,24</b>
<b>264 043</b>	CC	160	80	10	<b>34,51</b>

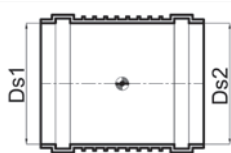

**Manicotti con battuta STMM**



Codice	Classe	Ds1=Ds2	Z2	Pallet.	Conf.	Euro pz.
<b>264802</b>	CC	32	1	1600	10	<b>4,74</b>
<b>264803</b>	CC	40	1	1600	10	<b>4,92</b>
<b>264805</b>	CC	50	1	1280	10	<b>5,16</b>
<b>264808</b>	CC	75	2	480	10	<b>7,42</b>
<b>264809</b>	CC	90	2	320	10	<b>11,54</b>
<b>264810</b>	CC	110	2	240	10	<b>12,03</b>
<b>264811</b>	CC	125	3	160	20	<b>22,91</b>
<b>264812</b>	CC	160	4	80	10	<b>33,03</b>

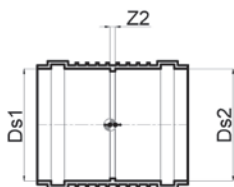



**T-Trap**

Codice	Classe	Descrizione	Pallet	Conf.	Euro pz.
<b>3086119</b>	CC	Pozzetto pavimento		2	<b>46,12</b>
Ricambio					
<b>3086121</b>	CC	Paratia pozzetto pavimento		1	<b>21,17</b>

**Bicchieri a profondità maggiorata STLL**

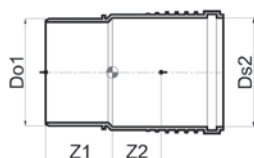

Codice	Classe	Do1=Ds2	Z1	Z2	Pallet	Conf.	Euro pz.
<b>264103</b>	CC	40	50	53	800	10	<b>7,48</b>
<b>264105</b>	CC	50	52	56	800	10	<b>7,20</b>
<b>264108</b>	CC	75	59	64	320	10	<b>10,03</b>
<b>264109</b>	CC	90	63	70	240	10	<b>16,01</b>
<b>264110</b>	CC	110	152	79	160	10	<b>16,60</b>
<b>264111</b>	CC	125	171	91	120	10	<b>24,00</b>
<b>264113</b>	CC	160	187	99	60	10	<b>48,51</b>

**Aumenti eccentrici STR Tipo A**

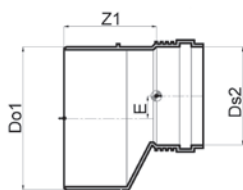

Codice	Classe	Ds2/Do1	Z1	E	Pallet	Conf.	Euro pz.
<b>260608</b>	CC	32/40	60	3	2560	20	<b>5,41</b>
<b>260615</b>	CC	32/50	66	9	1600	20	<b>5,45</b>
<b>260616</b>	CC	40/50	63	5	1600	20	<b>5,24</b>
<b>260631</b>	CC	50/75	77	12	640	20	<b>6,53</b>
<b>260643</b>	CC	50/110	106	27	320	20	<b>9,87</b>
<b>260602</b>	CC	75/110	98	17	480	20	<b>9,75</b>
<b>260655</b>	CC	110/125	98	7	160	20	<b>17,89</b>
<b>260671</b>	CC	110/160	121	24	160	20	<b>26,99</b>
<b>260672</b>	CC	125/160	117	16	160	20	<b>26,99</b>

**Aumenti eccentrici STR Tipo B**

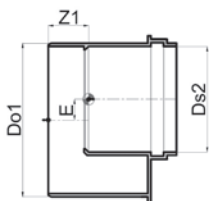

Codice	Classe	Ds2/Do1	Z1	E	Pallet	Conf.	Euro pz.
<b>260636</b>	CC	50/90	27	17	640	20	<b>9,27</b>
<b>260639</b>	CC	75/90	22	4	640	20	<b>10,03</b>
<b>260645</b>	CC	50/110	27	17	640	20	<b>9,69</b>
<b>260646</b>	CC	75/110	22	4	480	20	<b>11,57</b>
<b>260647</b>	CC	90/110	26	6	480	20	<b>11,05</b>



**Aumenti concentrici**

Codice	Classe	d2/d1	H	Pallet	Conf.	Euro pz.
<b>260634</b>	CC	32/40	65	5120	40	<b>5,43</b>
<b>260637</b>	CC	40/50	55	3200	40	<b>7,62</b>

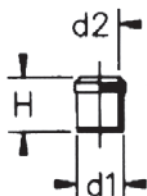

**Tappi di chiusura STM**

Codice	Classe	Do1	Z1	Pallet	Conf.	Euro pz.
<b>264542</b>	CC	32	45	1600	10	<b>3,98</b>
<b>264543</b>	CC	40	47,5	1600	10	<b>4,54</b>
<b>264546</b>	CC	50	48,5	1600	10	<b>5,18</b>
<b>264551</b>	CC	75	54,5	1280	10	<b>6,70</b>
<b>264552</b>	CC	90	37,4	1280	10	<b>12,24</b>
<b>264553</b>	CC	110	69,5	640	10	<b>15,18</b>
<b>264554</b>	CC	125	69,0	480	10	<b>20,79</b>
<b>264555</b>	CC	160	98,2	160	10	<b>26,36</b>

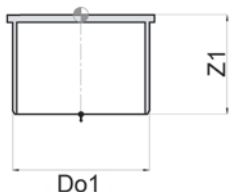

**Curve tecniche normali e prolungate STSW**

Codice	Classe	Do1/Ds2	Z1	Z2	Pallet	Conf.	Euro pz.
<b>263900</b>	CC	32/46	70	24	1600	20	<b>4,79</b>
<b>263901</b>	CC	40/46	79	30	1280	20	<b>6,77</b>
<b>263902</b>	CC	50/53	79	35	1280	20	<b>7,76</b>
<b>263926</b>	CC	40/46 Prolungata	125	30	480	20	<b>7,76</b>

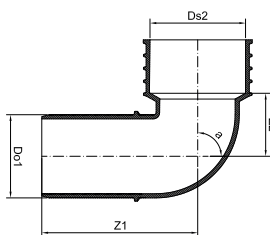

d4= 53 Morsetto 1" 1/4 cod. **308 046**  
 d4= 53 Morsetto 1" 1/2 cod. **308 048**

**Manicotti sifone STS**

Codice	Classe	Do1/Ds2	Z1	Pallet	Conf.	Euro pz.
<b>263910</b>	CC	32/46	52	1600	20	<b>9,29</b>
<b>263911</b>	CC	40/46	54	1600	20	<b>9,19</b>
<b>263912</b>	CC	50/53	55	960	20	<b>9,29</b>



d4= 53 Morsetto 1" 1/4 cod. **308 046**  
 d4= 53 Morsetto 1" 1/2 cod. **308 048**



**Curve WC (con guarnizione e tappo) HTSB**

Codice	Classe	d1	l	L	Pallet	Conf.	Euro pz.
<b>243082D</b>	A2	110	100	230		10	<b>30,49</b>

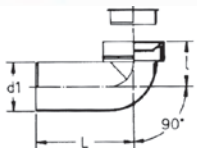

**Curve WC con attacco orientabile (con guarnizione e tappo) HTSB**

Codice	Classe	d1/d2	Conf.	Euro pz.
<b>243109D</b>	A2	110/50	10	<b>45,11</b>

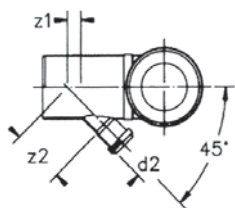

**Curve WC prolungate (con guarnizione e tappo) HTSBL**

Codice	Classe	d1/d2	l	L	Pallet	Conf.	Euro pz.
<b>243086D</b>	A2	90	170	106	160	20	<b>25,62</b>
<b>243087D</b>	A2	110	185	230	120	10	<b>28,13</b>

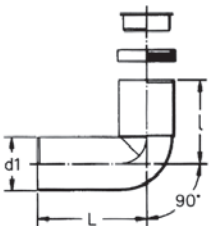

**Curve WC prolungate con attacco orientabile (con guarnizione e tappo) HTSBL**

Codice	Classe	d1/d2	Pallet	Conf.	Euro pz.
<b>243113D</b>	A2	90/40	120	10	<b>42,01</b>
<b>243114D</b>	A2	90/50	120	10	<b>44,10</b>
<b>243118D</b>	A2	110/40	120	10	<b>42,62</b>
<b>243119D</b>	A2	110/50	120	10	<b>43,45</b>

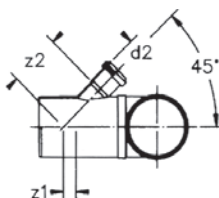



**Curve WC prolungate con 2 attacchi (con guarnizione e tappo) HTSBL**

Codice	Classe	d1/d2	Pallet	Conf.	Euro pz.
<b>243111D</b>	A2	90/40	80	10	<b>59,61</b>
<b>243112D</b>	A2	90/50	80	10	<b>62,77</b>
<b>243115D</b>	A2	110/40	80	10	<b>57,02</b>
<b>243116D</b>	A2	110/50	80	10	<b>58,26</b>

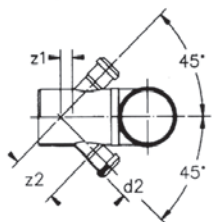

**Curva WC prolungata con 4 attacchi ø 40 (con guarnizione e tappo) HTSBL**

Codice	Classe	d1/d2	i	z1	z2	Pallet	Conf.	Euro pz.
<b>243107D</b>	A2	110/40	185	-24	95	60	5	<b>65,54</b>

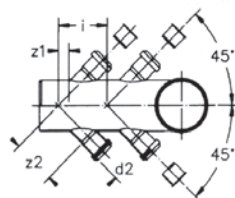

**Accessori**

**Consultare l'apposito capitolo "ACCESSORI PER LO SCARICO" per i seguenti articoli:**

- Morsetti per curve tecniche e manicotti sifone
- Bracciali di fissaggio per tubi
- Raccordi di passaggio al PVC
- Scivolante



## Ricambi WAVIN SITECH+

Codice	Classe	Descrizione	Conf.	Euro pz.
<b>800013</b>	W1	Guarnizionealabbro32	40	<b>0,74</b>
<b>800014</b>	W1	Guarnizionealabbro40	33	<b>0,74</b>
<b>800015</b>	W1	Guarnizionealabbro50	35	<b>0,74</b>
<b>800010</b>	W1	Guarnizionealabbro63	50	<b>1,35</b>
<b>800016</b>	W1	Guarnizionealabbro75	34	<b>1,00</b>
<b>800011</b>	W1	Guarnizionealabbro90	32	<b>0,93</b>
<b>800017</b>	W1	Guarnizionealabbro110	45	<b>1,14</b>
<b>800018</b>	W1	Guarnizionealabbro125	40	<b>1,72</b>
<b>800019</b>	W1	Guarnizionealabbro160	34	<b>1,73</b>



# Wavin AS+



AS+

**GAMMA**

Wavin AS+ è un sistema di tubazioni fonoassorbenti in polipropilene rinforzato da sostanze minerali (PP). Struttura triplo strato per connessioni ad innesto, con guarnizione in EPDM pre-lubrificata, per un'installazione facile, veloce ed affidabile.

Diametro nominale mm	Diametro esterno mm	Diametro interno mm	Spessore mm
50	50	44	3,0
70	75	68	3,5
90	90	80,8	4,6
100	110	99,4	5,3
125	125	114,4	5,3
150	160	148,8	5,6
200	200	188	6,0

**SPECIFICHE TECNICHE****Materiale**

Polipropilene caricato mineralmente

**Metodo di giunzione**

Giunzioni con bicchiere con guarnizione in EPDM pre-lubrificata

**Comportamento al fuoco**

Classe B2, in accordo alla DIN 4102; Classe D-s3,d0 in accordo alla EN13501-1

**Densità**

1,9 gr/cm<sup>3</sup> in accordo alla DIN 53479

**Temperatura di esercizio**

90°C temperatura massima; 100°C per brevi periodi

**Coefficiente di dilatazione**

≈ 0,06 mm/m/K

**Livello acustico (report n° P-BA 64/2019)**

<10 dB(A) Rif. 2.0 l/s (in accordo alla nuova procedura di test del Fraunhofer Institute, valida da Gennaio 2014)

**Colore**

Grigio chiaro RAL7035

**Applicazioni**











Wavin AS+ è resistente all'acqua calda e soddisfa o addirittura eccede tutti i requisiti della normativa EN 12056 e le normative correlate stabilite all'interno della DIN 1986-100, come ad esempio l'esposizione a breve termine a temperature di 95°C e l'esposizione a lungo termine a temperature di 90°C.

La resistenza chimica del Wavin AS+ lo rende adatto al trasporto delle acque reflue nell'intervallo di pH 2-12.

Wavin AS+ può essere utilizzato per il drenaggio all'interno degli edifici, per i pluviali e per le applicazioni nel sottosuolo.

La notevole prestazione acustica del WAVIN AS+ lo rende ideale ogni volta che è necessaria un'insonorizzazione conforme alla DIN 4109, come ad esempio all'interno di ospedali, case di riposo, edifici per uffici o case/condomini.

Le eccellenti proprietà di protezione acustica di Wavin AS+ vengono attribuite soprattutto al suo design a pareti spesse, ma anche alla speciale struttura molecolare e all'alta densità del materiale ~1,9 g/cm<sup>3</sup>. Questa proprietà consente a Wavin AS+ di assorbire il rumore aereo e le vibrazioni meccaniche.

		DN 50	DN 70	DN 90	DN 100	DN 125	DN 150	DN 200
Tubazioni		✓	✓	✓	✓	✓	✓	✓
Manicotti con battuta		✓	✓	✓	✓	✓	✓	✓
Curve		✓	✓	✓	✓	✓	✓	✓
Curve prolungate				✓	✓			
Curve Tecniche		✓						
Manicotto sifone		✓						
Braghe		✓	✓	✓	✓	✓	✓	✓
Braghe doppie				✓	✓			
Braghe a scagno				✓	✓			
Braghe parallele				✓	✓			
Braghe con attacco doccia				✓	✓			
Manicotti scorrevoli		✓	✓	✓	✓	✓	✓	✓

		DN 50	DN 70	DN 90	DN 100	DN 125	DN 150	DN 200
Bicchieri a profondità maggiorata		✓	✓	✓	✓	✓	✓	✓
Tappi		✓	✓	✓	✓	✓	✓	✓
Riduzioni			✓	✓	✓	✓	✓	✓
Ispezioni		✓	✓	✓	✓	✓	✓	✓
Bracciali		✓	✓	✓	✓	✓	✓	✓
Bracciali LKS		✓	✓	✓	✓	✓	✓	✓
Guarnizioni in EPDM		✓	✓	✓	✓	✓	✓	✓
Guarnizioni in NBR		✓	✓	✓	✓	✓	✓	✓
Adattatori in EPDM per connessione AS / AS+		✓	✓			✓		

**Tubi con bicchiere**

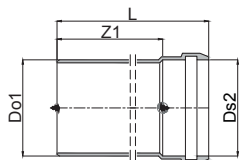

Codice	Classe	DN	Do1 mm	L mm	Ds2 mm	Z1 mm	Peso Kg/PC	Pallet	Conf.	Euro pz.
<b>3080057</b>	C1	50	50	198	50	150	0,180	384	6	<b>13,02</b>
<b>3080058</b>	C1	50	50	298	50	250	0,262	384	6	<b>13,21</b>
<b>3080059</b>	C1	50	50	546	50	500	0,437	225	1	<b>22,39</b>
<b>3080060</b>	C1	50	50	1046	50	1000	0,825	123	1	<b>36,53</b>
<b>3080061</b>	C1	50	50	2046	50	2000	1,605	123	1	<b>64,79</b>
<b>3080063</b>	C1	50	50	3046	50	3000	2,383	123	1	<b>91,61</b>
<b>3080064</b>	C1	70	75	202	75	150	0,297	336	14	<b>14,08</b>
<b>3080065</b>	C1	70	75	302	75	250	0,442	192	3	<b>15,53</b>
<b>3080066</b>	C1	70	75	551	75	500	0,787	180	1	<b>24,14</b>
<b>3080067</b>	C1	70	75	1051	75	1000	1,490	70	1	<b>39,23</b>
<b>3080068</b>	C1	70	75	2051	75	2000	2,896	70	1	<b>69,48</b>
<b>3080070</b>	C1	70	75	3051	75	3000	4,302	70	1	<b>99,78</b>
<b>3080071</b>	C1	90	90	205	90	150	0,465	256	4	<b>18,94</b>
<b>3080072</b>	C1	90	90	305	90	250	0,692	192	3	<b>19,07</b>
<b>3080073</b>	C1	90	90	554	90	500	1,250	125	1	<b>27,24</b>
<b>3080074</b>	C1	90	90	1054	90	1000	2,366	60	1	<b>45,49</b>
<b>3080075</b>	C1	90	90	2054	90	2000	4,597	60	1	<b>80,55</b>
<b>3080077</b>	C1	90	90	3054	90	3000	6,829	60	1	<b>117,29</b>
<b>3080030</b>	C1	100	110	209	110	150	0,675	128	8	<b>17,67</b>
<b>3080031</b>	C1	100	110	309	110	250	1,017	96	4	<b>20,72</b>
<b>3080032</b>	C1	100	110	559	110	500	1,830	80	1	<b>31,24</b>
<b>3080033</b>	C1	100	110	1059	110	1000	3,407	40	1	<b>51,58</b>
<b>3080034</b>	C1	100	110	2059	110	2000	6,562	40	1	<b>91,91</b>
<b>3080036</b>	C1	100	110	3059	110	3000	9,716	40	1	<b>132,89</b>
<b>3080037</b>	C1	125	125	213	125	150	0,788	96	2	<b>29,33</b>
<b>3080038</b>	C1	125	125	313	125	250	1,155	96	2	<b>31,45</b>
<b>3080039</b>	C1	125	125	562	125	500	2,092	60	1	<b>41,74</b>
<b>3080040</b>	C1	125	125	1062	125	1000	3,895	27	1	<b>61,68</b>
<b>3080041</b>	C1	125	125	2062	125	2000	7,502	27	1	<b>120,54</b>
<b>3080043</b>	C1	125	125	3062	125	3000	11,109	27	1	<b>167,02</b>
<b>3080044</b>	C1	150	160	221,4	160	150	1,088	48	3	<b>34,57</b>
<b>3080045</b>	C1	150	160	321,4	160	250	1,088	48	3	<b>51,24</b>
<b>3080046</b>	C1	150	160	570,2	160	500	2,865	35	1	<b>52,58</b>
<b>3080047</b>	C1	150	160	1070	160	1000	5,334	18	1	<b>92,79</b>
<b>3080048</b>	C1	150	160	2070	160	2000	10,272	18	1	<b>181,17</b>
<b>3080050</b>	C1	150	160	3070	160	3000	15,211	18	1	<b>266,66</b>
<b>3080051</b>	C1	200	200	328	200	250	2,05		1	<b>74,30</b>
<b>3080052</b>	C1	200	200	584	200	500	4,145		1	<b>77,09</b>
<b>3080053</b>	C1	200	200	1084	200	1000	7,488		1	<b>134,66</b>
<b>3080054</b>	C1	200	200	2084	200	2000	14,172		1	<b>241,94</b>
<b>3080056</b>	C1	200	200	3084	200	3000	20,857		1	<b>348,08</b>



**Manicotti con battuta**

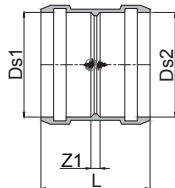

Codice	Classe	DN	Ds1 mm	L mm	Ds2 mm	Z1 mm	Peso Kg/PC	Pallet	Conf.	Euro pz.
<b>3080016</b>	C2	50	50	99	50	3	0,123	864	18	<b>18,27</b>
<b>3080017</b>	C2	70	75	107	75	3	0,174	480	20	<b>18,27</b>
<b>3080018</b>	C2	90	90	114	90	3	0,263	228	12	<b>23,98</b>
<b>3080012</b>	C2	100	110	124	110	5	0,391	192	8	<b>26,69</b>
<b>3080013</b>	C2	125	125	132	125	5	0,512	144	6	<b>46,15</b>
<b>3080014</b>	C2	150	160	148	160	5	0,755	96	6	<b>58,40</b>
<b>3080015</b>	C2	150	200	181	200	8	1,327	48	3	<b>66,43</b>



**Curve 15°, 30°, 45°, 67°, 87°**

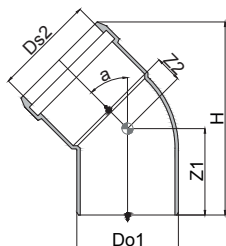

Codice	Classe	α	DN	Ds1 mm	Ds2 mm	Z1 mm	Z2 mm	h mm	Peso Kg/PC	Pallet	Conf.	Euro pz.
<b>3079965</b>	C2	15°	50	50	50	53	11	115	0,108	960	20	<b>19,23</b>
<b>3079966</b>	C2	30°	50	50	50	57	13	122	0,115	864	18	<b>18,89</b>
<b>3079967</b>	C2	45°	50	50	50	60	18	126	0,124	768	16	<b>19,50</b>
<b>3079968</b>	C2	67°	50	50	50	68	23	124	0,130	576	12	<b>19,35</b>
<b>3079969</b>	C2	87°	50	50	50	74	32	111	0,146	576	12	<b>21,40</b>
<b>3079970</b>	C2	15°	70	75	75	59	11	129	0,179	384	16	<b>18,54</b>
<b>3079971</b>	C2	30°	70	75	75	64	15	141	0,193	384	16	<b>18,62</b>
<b>3079972</b>	C2	45°	70	75	75	70	21	150	0,217	384	16	<b>20,74</b>
<b>3079973</b>	C2	67°	70	75	75	79	29	150	0,229	288	12	<b>20,50</b>
<b>3079974</b>	C2	87°	70	75	75	90	41	141	0,251	336	14	<b>21,40</b>
<b>3079975</b>	C2	15°	90	90	90	64	15	141	0,299	336	14	<b>24,68</b>
<b>3079976</b>	C2	30°	90	90	90	70	20	157	0,324	288	12	<b>26,28</b>
<b>3079977</b>	C2	45°	90	90	90	73	25	167	0,364	240	10	<b>26,55</b>
<b>3079978</b>	C2	67°	90	90	90	88	37	172	0,390	240	10	<b>28,08</b>
<b>3079979</b>	C2	87°	90	90	90	101	49	160	0,428	192	8	<b>28,08</b>
<b>3079950</b>	C2	15°	100	110	110	70	17	157	0,466	192	8	<b>26,66</b>
<b>3079951</b>	C2	30°	100	110	110	77	20	177	0,517	144	6	<b>27,54</b>
<b>3079952</b>	C2	45°	100	110	110	85	32	192	0,565	128	8	<b>28,77</b>
<b>3079953</b>	C2	67°	100	110	110	99	44	197	0,606	144	6	<b>26,89</b>
<b>3079954</b>	C2	87°	100	110	110	114	61	186	0,694	96	4	<b>30,38</b>
<b>3079955</b>	C2	15°	125	125	125	75	17	167	0,568	96	4	<b>43,12</b>
<b>3079956</b>	C2	30°	125	125	125	83	25	191	0,628	96	4	<b>43,66</b>
<b>3079957</b>	C2	45°	125	125	125	92	34	208	0,632	96	4	<b>42,50</b>
<b>3079958</b>	C2	87°	125	125	125	126	67	206	0,864	72	3	<b>50,42</b>
<b>3079959</b>	C2	15°	150	160	160	85	19	181	0,852	48	3	<b>59,15</b>
<b>3079960</b>	C2	30°	150	160	160	96	28	191	0,950	48	3	<b>59,33</b>
<b>3079961</b>	C2	45°	150	160	160	108	42	208	1,075	48	3	<b>59,33</b>
<b>3079962</b>	C2	87°	150	160	160	151	84	206	1,384	32	2	<b>70,92</b>
<b>3079963</b>	C2	45°	200	200	200	132	51	206	1,814	24	1	<b>89,08</b>
<b>3079964</b>	C2	87°	200	200	200	185	42	206	2,314	24	1	<b>109,80</b>





**Curve prolungate**

Codice	Classe	DN	Do1 mm	Ds2 mm	Z1 mm	h mm	Peso Kg/PC	Pallet	Conf.	Euro pz.
<b>3080027</b>	C2	90	90	90	250	25	0,807	96	4	<b>44,90</b>
<b>3080026</b>	C2	100	110	110	250	25	1,137	72	3	<b>59,52</b>

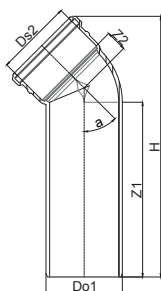

**Curva Tecnica**

Codice	Classe	DN	Do1 mm	Ds2 mm	Z1 mm	Z2 mm	h mm	Peso Kg/PC	Pallet	Conf.	Euro pz.
<b>R 3080101</b>	C2	50	50	53	79	35	123	0,051	960	20	<b>8,01</b>

d4= 53 Morsetto 1" 1/4 cod. 308 046  
 d4= 53 Morsetto 1" 1/2 cod. 308 048

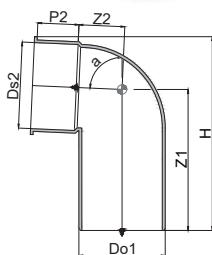

**Manicotto sifone**

Codice	Classe	DN mm	Do1 mm	Ds2 mm	Z1 mm	Z2 mm	h mm	Peso Kg/PC	Pallet	Conf.	Euro pz.
<b>R 3080102</b>	C2	50	50	53	53	40	120	0,051	960	20	<b>9,45</b>

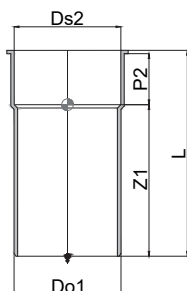

R Contattare il Customer Service per tempistiche sulla disponibilita



**Braghe 45° e 87°**

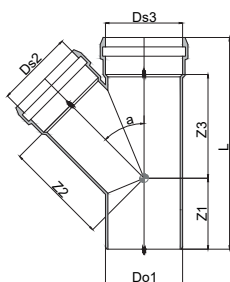

Codice	Classe	DN	$\alpha$	Do1 mm	L mm	Ds2 mm	Ds3 mm	Z1 mm	Z2 mm	Z3 mm	Peso Kg/PC	Pallet	Conf.	Euro pz.
<b>3079996</b>	C2	50/50	45°	50	171	50	50	60	62	62	0,250	288	6	<b>35,82</b>
<b>3079997</b>	C2		87°	50	150	50	50	75	29	29	0,202	288	6	<b>39,05</b>
<b>3079998</b>	C2	70/50	45°	75	178	50	75	52	82	78	0,336	144	6	<b>35,99</b>
<b>3079999</b>	C2		87°	75	158	50	75	78	42	30	0,291	192	8	<b>35,82</b>
<b>3080000</b>	C2	70/70	45°	75	215	75	75	69	95	95	0,442	144	6	<b>38,93</b>
<b>3080001</b>	C2		87°	75	183	75	75	90	45	42	0,343	144	6	<b>38,85</b>
<b>3080002</b>	C2	90/50	45°	90	185	50	90	55	93	77	0,487	144	6	<b>44,16</b>
<b>3080003</b>	C2		87°	90	186	50	90	82	52	30	0,432	192	8	<b>46,08</b>
<b>3080004</b>	C2	90/70	45°	90	220	75	90	65	106	103	0,610	144	6	<b>46,47</b>
<b>3080005</b>	C2		87°	90	191	75	90	93	49	45	0,495	144	6	<b>45,96</b>
<b>3080006</b>	C2	90/90	45°	90	243	90	90	76	114	114	0,757	96	4	<b>38,59</b>
<b>3080007</b>	C2		87°	90	224	90	90	124	68	48	0,646	96	4	<b>50,42</b>
<b>3079982</b>	C2	100/50	45°	110	197	50	110	59	106	81	0,689	96	4	<b>44,56</b>
<b>3079983</b>	C2		87°	110	178	50	110	85	59	36	0,637	96	4	<b>44,36</b>
<b>3079984</b>	C2	100/70	45°	110	230	75	110	59	120	114	0,836	96	4	<b>48,66</b>
<b>3079985</b>	C2		87°	110	200	75	110	97	59	46	0,695	96	4	<b>50,09</b>
<b>3079986</b>	C2	100/90	45°	110	249	90	110	69	128	123	0,986	72	3	<b>52,65</b>
<b>3079987</b>	C2		87°	110	216	90	110	105	60	55	0,791	96	4	<b>52,65</b>
<b>3079981</b>	C2	100/100	45°	110	277	111	110	83	138	138	1,216	48	2	<b>53,29</b>
<b>3079980</b>	C2		87°	110	253	110	110	136	77	56	1,061	64	4	<b>53,29</b>
<b>3079988</b>	C2	125/100	45°	125	291	110	125	81	152	149	1,410	48	2	<b>80,54</b>
<b>3079989</b>	C2		87°	125	241	110	125	118	70	63	1,056	72	3	<b>83,22</b>
<b>3079990</b>	C2	125/125	45°	125	310	125	125	91	158	158	1,607	48	2	<b>103,71</b>
<b>3079991</b>	C2	150/100	45°	160	304	110	160	71	175	165	1,822	32	2	<b>111,54</b>
<b>3079992</b>	C2		87°	160	256	110	160	124	87	65	1,424	48	2	<b>177,53</b>
<b>3079993</b>	C2	150/125	45°	160	326	125	160	82	184	176	2,029	32	2	<b>177,53</b>
<b>3079994</b>	C2	150/150	45°	160	375	160	160	108	200	199	2,519	16	1	<b>177,53</b>
<b>R 3079995</b>	C2	200/200	45°	200	460	200	200	128	250	250	4,259	8	1	<b>222,79</b>



**Braghe doppie a flusso avviato**

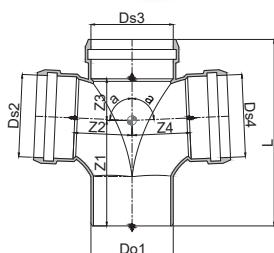

Codice	Classe	DN	Do1 mm	L mm	Ds2 mm	Ds3 mm	Ds4 mm	Z1 mm	Z2 mm	Z3 mm	Z4 mm	Peso Kg/ PC	Pallet	Conf.	Euro pz.
<b>3080011</b>	C2	90/90/90	90	224	90	124	68	48	0,820	48	2	<b>124,19</b>			
<b>3080010</b>	C2	100/100/100	110	255	110	139	81	60	1,263	48	2	<b>129,77</b>			

R Contattare il Customer Service per tempistiche sulla disponibilita



**Braghe a scagno 87°**

Codice	Classe	DN	$\alpha$	Do1 mm	L mm	Ds2 mm	Z1 mm	Z2 mm	Z3 mm	Z4 mm	Peso Kg/PC	Pallet	Conf.	Euro pz.
--------	--------	----	----------	-----------	---------	-----------	----------	----------	----------	----------	---------------	--------	-------	-------------

<b>3080009</b>	C2	90/90/90	87	90	218	90	111	66	51	51	0,856	48	2	<b>179,04</b>
<b>3080008</b>	C2	100/100/100	87	110	251	110	122	139	128	139	1,131	48	2	<b>184,16</b>

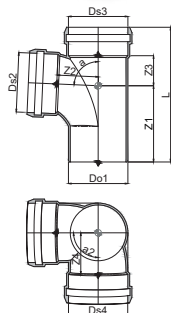

**Braghe parallele**

Codice	Classe	DN	Do1 mm	L mm	Ds2 mm	Z mm	Z1 mm	Z2 mm	Z3 mm	E mm	Peso Kg/PC	Pallet	Conf.	Euro pz.
--------	--------	----	-----------	---------	-----------	---------	----------	----------	----------	---------	---------------	--------	-------	-------------

<b>3080029</b>	C2	90/90/90	90	260	90	151	74	25	118	105	0,684	96	2	<b>175,04</b>
<b>3080028</b>	C2	100/100	110	303	110	186	87	32	145	130	1,138	48	2	<b>180,16</b>

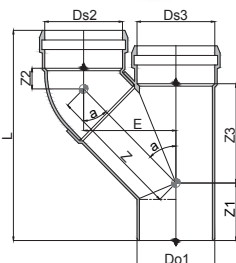

**Braghe doppie con attacco doccia 87°**

Codice	Classe	DN	Do1 mm	L mm	Ds2 mm	Ds3 mm	Z mm	Z1 mm	Z2 mm	Z3 mm	Peso Kg/PC	Pallet	Conf.	Euro pz.
--------	--------	----	-----------	---------	-----------	-----------	---------	----------	----------	----------	---------------	--------	-------	-------------

<b>3080098</b>	C2	90/90/50	90	296	50	90	114	82	51	68	1,11	48	2	<b>192,03</b>
<b>3080111</b>	C2	90/90/70	90	296	75	90	114	82	51	68	1,18	48	2	<b>191,78</b>
<b>3080095</b>	C2	100/100/50	110	330	50	110	126	87	59	81	1,78	48	2	<b>181,79</b>
<b>3080110</b>	C2	100/100/70	110	330	75	110	126	87	59	81	1,83	48	2	<b>183,16</b>

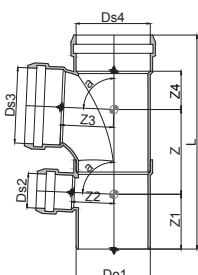



**Braghe doppie con attacco doccia a sinistra 87°**

Codice	Classe	DN	Do1 mm	L mm	Ds2 mm	Ds3 mm Ds4 mm	Z mm	Z1 mm	Z2 mm	Z3 mm	Peso Kg/PC	Pallet	Conf.	Euro pz.
<b>3080099</b>	C2	90/90/50	90	296	50	90	114	82	51	68	1,11	48	2	<b>192,03</b>
<b>3080096</b>	C2	100/100/50	110	330	50	110	126	87	59	81	1,78	48	2	<b>183,53</b>

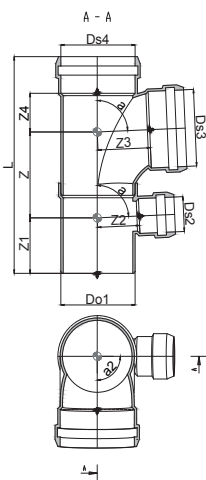

**Braghe doppie con attacco doccia a destra 87°**



Codice	Classe	DN	Do1 mm	L mm	Ds2 mm	Ds3 mm Ds4 mm	Z mm	Z1 mm	Z2 mm	Z3 mm	Peso Kg/PC	Pallet	Conf.	Euro pz.
<b>3080100</b>	C2	90/90/50	90	296	50	90	114	82	51	68	1,11	48	2	<b>192,03</b>
<b>3080097</b>	C2	100/100/50	110	330	50	110	126	87	59	81	1,78	48	2	<b>183,53</b>

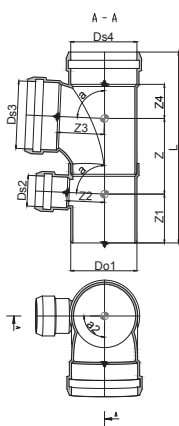



**Manicotti Scorrevoli**

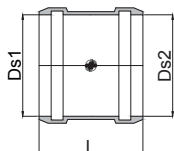

Codice	Classe	DN	L mm	Ds1 mm	Ds2 mm	Peso Kg/PC	Pallet	Conf.	Euro pz.
<b>3080092</b>	C2	50	99	50	50	0,121	864	18	<b>13,02</b>
<b>3080093</b>	C2	70	107	75	75	0,170	480	20	<b>13,02</b>
<b>R 3080094</b>	C2	90	114	90	90	0,263	288	12	<b>18,73</b>
<b>3080088</b>	C2	100	124	110	110	0,387	192	8	<b>17,37</b>
<b>3080089</b>	C2	125	132	125	125	0,512	144	6	<b>36,96</b>
<b>3080090</b>	C2	150	148	160	160	0,755	96	6	<b>36,08</b>
<b>R 3080091</b>	C2	200	181	200	200		48	3	<b>54,62</b>



**Bicchieri a profondita maggiorata**

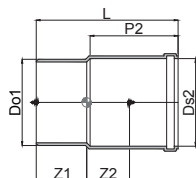

Codice	Classe	DN	Do1 mm	L mm	Ds2 mm	P2 mm	Z1 mm	Z2 mm	Peso Kg/PC	Pallet	Conf.	Euro pz.
<b>3080023</b>	C2	50	50	184	50	105	57	60	0,178	320	5	<b>27,91</b>
<b>3080024</b>	C2	70	75	199	75	129	62	66	0,268	256	4	<b>22,49</b>
<b>3080025</b>	C2	90	90	202	90	125	66	92	0,421	144	3	<b>27,62</b>
<b>3080019</b>	C2	100	110	219	110	137	69	88	0,657	128	8	<b>39,48</b>
<b>3080020</b>	C2	125	110	237	110	148	74	79	0,811	96	4	<b>45,74</b>
<b>3080021</b>	C2	150	125	264	125	164	85	123	1,183	48	3	<b>55,34</b>
<b>R 3080022</b>	C2	200	160	425	160	184	199	130	3,200	16	1	<b>115,72</b>



**Tappi**

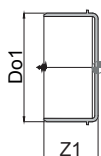

Codice	Classe	DN	Do1 mm	Z1 mm	Peso Kg/PC	Pallet	Conf.	Euro pz.
<b>3080106</b>	C2	50	50	51	0,055	1536	24	<b>10,37</b>
<b>3080107</b>	C2	70	75	55	0,108	960	20	<b>14,88</b>
<b>3080108</b>	C2	90	90	60	0,186	576	12	<b>18,44</b>
<b>3080103</b>	C2	100	110	65	0,290	384	8	<b>22,17</b>
<b>3080104</b>	C2	125	125	68	0,360	240	5	<b>32,59</b>
<b>3080105</b>	C2	150	160	76	0,565	192	8	<b>41,78</b>
<b>3081792</b>	C2	200	200	128	1,030	72	3	<b>43,61</b>

R Contattare il Customer Service per tempistiche sulla disponibilita

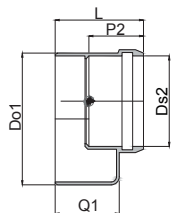

**Aumenti eccentrici**

Codice	Classe	DN	Do1 mm	L mm	Ds2 mm	P2 mm	Q1 mm	Peso Kg/PC	Pallet	Conf.	Euro pz.
<b>3080085</b>	C2	70/50	75	79	50	48	68	0,151	768	16	<b>14,08</b>
<b>3080086</b>	C2	90/50	90	86	50	19	72	0,222	672	28	<b>20,74</b>
<b>3080087</b>	C2	90/70	90	85	75	52		0,193	672	28	<b>21,66</b>
<b>3080078</b>	C2	100/50	110	90	50	53	79	0,356	288	6	<b>18,44</b>
<b>3080079</b>	C2	100/70	110	90	75	57	79	0,334	288	6	<b>18,54</b>
<b>3080080</b>	C2	100/90	110	91	90	61	78	0,328	288	12	<b>24,07</b>
<b>3080081</b>	C2	125/100	125	99	110	59		0,371	192	4	<b>30,66</b>
<b>3080082</b>	C2	150/100	160	114	110	59	98	0,691	120	5	<b>41,85</b>
<b>3080083</b>	C2	150/125	160	114	125	63	98	0,706	120	5	<b>47,06</b>
<b>3080084</b>	C2	200/150	200	130	160	24	114	1,022	48	3	<b>59,03</b>

**Ispezioni**

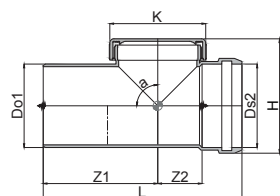

Codice	Classe	Do1 mm	L mm	Ds2 mm	Z1 mm	Z2 mm	K mm	H mm	Peso Kg/PC	Pallet	Conf.	Euro pz.
<b>3079917</b>	C2	50	164	50	82	37	65	84		288	6	<b>46,67</b>
<b>3079918</b>	C2	75	200	75	97	53	93	111		192	8	<b>49,88</b>
<b>3079949</b>	C2	90	228	90	114	62	111	131		192	4	<b>59,79</b>
<b>3079913</b>	C2	110	258	110	129	72	130	156		96	4	<b>69,30</b>
<b>3079914</b>	C2	125	259	125	127	71	130	174		48	2	<b>148,90</b>
<b>3079915</b>	C2	160	271	160	135	68	130	213		48	2	<b>188,66</b>
<b>3079916</b>	C2	200	425	200	180	165	141	269		24	1	<b>261,05</b>

## Accessori

### Bracciali LKS



Codice	Classe	DN	Pallet	Conf.	Euro pz.
<b>4065138</b>	W2	50	1700	50	<b>24,31</b>
<b>4065139</b>	W2	70	1020	30	<b>28,22</b>
<b>4065140</b>	W2	90	680	20	<b>29,87</b>
<b>4065141</b>	W2	100	680	20	<b>31,32</b>
<b>4065142</b>	W2	125	306	9	<b>41,51</b>
<b>4065143</b>	W2	150	160	10	<b>36,40</b>
<b>4065144</b>	W2	200	80	10	<b>42,62</b>

### Guarnizioni EPDM



Codice	Classe	DN	Pallet	Conf.	Euro pz.
<b>4065145</b>	Y3	50		1	<b>1,32</b>
<b>4065186</b>	Y3	70		1	<b>1,52</b>
<b>4065187</b>	Y3	90		1	<b>2,56</b>
<b>4065188</b>	Y3	100		1	<b>2,31</b>
<b>4065189</b>	Y3	125		1	<b>4,11</b>
<b>4065190</b>	Y3	150		1	<b>5,01</b>
<b>4065191</b>	Y3	200		1	<b>5,38</b>

### Bracciali di fissaggio con fascetta in gomma antivibrante per Wavin AS+ e Wavin Sitech+



Codice	Classe	de mm	Peso Kg/PC	Pallet	Conf.	Euro pz.
<b>4066447</b>	W2	32			50	<b>9,67</b>
<b>4066448</b>	W2	40			50	<b>9,89</b>
<b>4066449</b>	W2	50			50	<b>10,72</b>
<b>4066450</b>	W2	75			50	<b>13,33</b>
<b>4066451</b>	W2	90			25	<b>17,63</b>
<b>4066452</b>	W2	110			25	<b>18,24</b>
<b>4066453</b>	W2	125			25	<b>25,48</b>
<b>4066454</b>	W2	160			10	<b>27,18</b>
<b>4066455</b>	W2	200			10	<b>47,60</b>



### Guarnizioni NBR

Codice	Classe	DN	Pallet	Conf.	Euro pz.
<b>4065192</b>	Y3	50		1	<b>5,01</b>
<b>4065193</b>	Y3	70		1	<b>5,01</b>
<b>4065194</b>	Y3	90		1	<b>5,01</b>
<b>R 4025566</b>	Y3	100		1	<b>5,01</b>
<b>R 4025567</b>	Y3	125		1	<b>5,64</b>
<b>R 4025568</b>	Y3	150		1	<b>5,64</b>
<b>R 4025569</b>	Y3	200		1	<b>6,30</b>



### Adattatori in EPDM per connessione AS / AS+

Codice	Classe	DN	Peso Kg/PC	Pallet	Conf.	Euro pz.
<b>4066491</b>	C2	58-50		1008	84	<b>22,94</b>
<b>4066492</b>	C2	78-75		600	50	<b>25,96</b>
<b>4066493</b>	C2	135-125		216	18	<b>49,81</b>

**R** Contattare il Customer Service per tempistiche sulla disponibilita



**Raccordi di passaggio PP - PE**

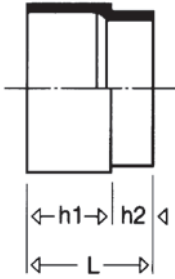

	Codice	Classe	$\varnothing A/B$	$h_1$	$h_2$	L	Note	Pallet	Conf.	Euro pz.
* R	<b>335914</b>	C2	50/58 mm	60	30	90	PP bianco	1200	12	<b>11,24</b>
R	<b>335907</b>	C2	78/75 mm			150	AS tornito		1	<b>36,62</b>



**B**  
Cod. 335 914  
Cod. 335 924



**B**  
Cod. 334 901



**B**  
Cod. 335 907

R Contattare il Customer Service per tempistiche sulla disponibilit  -\* Ad esaurimento



# Accessori scarico





**Raccordo di passaggio a 2 bicchieri in PVC**

Codice	Classe	Ø A/B	Conf.	Euro pz.
<b>300020</b>	W2	110/100 PVC diam. interno 110/110 PVC diam. esterno	10	<b>18,88</b>

A= tenuta a guarnizione Ø 110  
B= tenuta ad incollaggio Ø 106,5 esterno - Ø 100 interno



**Raccordi di passaggio in PVC**

Codice	Classe	Ø A/B	Conf.	Euro pz.
<b>300004</b>	W2	40/40	20	<b>6,28</b>
<b>300005</b>	W2	50/50	20	<b>6,37</b>
<b>300006</b>	W2	63/63	10	<b>13,33</b>
<b>300015</b>	W2	75/80	10	<b>15,92</b>
<b>300007</b>	W2	75/82	10	<b>16,28</b>
<b>300016</b>	W2	75/100	10	<b>15,92</b>
<b>300017</b>	W2	90/80	10	<b>20,22</b>
<b>300008</b>	W2	90/82	10	<b>19,51</b>
<b>300009</b>	W2	90/100	10	<b>18,52</b>
<b>300010</b>	W2	110/100	20	<b>19,33</b>
<b>300011</b>	W2	110/125	20	<b>17,47</b>
<b>300012</b>	W2	125/125	10	<b>22,38</b>
<b>300022</b>	W2	125/110	10	<b>22,45</b>

B= ad incollaggio



**Raccordo di passaggio femmina in PVC**

Codice	Classe	Ø A/B	Conf.	Euro pz.
<b>300019</b>	W2	100/110	10	<b>18,14</b>



**Tronchetto ridotto in PVC**

Codice	Classe	A	B	Conf.	Euro pz.
<b>R 301010</b>	W2	125	110	5	<b>43,68</b>
<b>R 301011</b>	W2	140	110	5	<b>52,88</b>
<b>R 301012</b>	W2	150	125	5	<b>67,82</b>

R Contattare il Customer Service per tempistiche sulla disponibilità



**Curve ridotte in PVC**

Codice	Classe	Ø A/B	α	Conf.	Euro pz.
<b>301002</b>	W2	110/100	15°	30	<b>23,34</b>
<b>301003</b>	W2	110/100	30°	30	<b>23,34</b>
<b>301004</b>	W2	110/100	45°	24	<b>23,00</b>
<b>301005</b>	W2	110/100	67°30'	20	<b>24,17</b>
<b>301006</b>	W2	110/100	87°30'	18	<b>23,00</b>



**Tappi di protezione per curve tecniche per Wavin ED TECH, Wavin SiTech e Wavin PE**

Codice	Classe	d	Conf.	Euro pz.
<b>R 309050</b>	W2	46	10	<b>0,29</b>



**Guarnizioni WC per Wavin ED TECH, Wavin PE**

Codice	Classe	Ø	Tipo di collegamento	Conf.	Euro pz.
<b>308020</b>	W1	120	Curva WC Tipo B	10	<b>6,44</b>
<b>308010</b>	W1	135	Curva WC Tipo A-C Turca	10	<b>6,62</b>
* <b>308107</b>	W1	107	Curva vaso a pavimento	10	<b>4,56</b>

\* Consente il collegamento tra il raccordo per scarico a pavimento, in dotazione al vaso e la curva WC prolungata.



**Collari di unione PE/Ghisa per Wavin PE, Wavin AS+**

Codice	Classe	Ø	Conf.	Euro pz.
<b>300510</b>	W2	90/80	20	<b>61,12</b>
<b>300511</b>	W2	110/100	30	<b>67,75</b>

**R** Contattare il Customer Service per tempistiche sulla disponibilità - \* Ad esaurimento



**Colletti di fissaggio in PE per punto fisso per Wavin PE**

Codice	Classe	Ø	Conf.	Euro pz.
R <b>305520</b>	W2	200	1	<b>108,85</b>



**Nastri in PVC per collari punto scorrevole per Wavin PE**

Codice	Classe	mt.	Ø Impiego	Conf.	Conf.	Euro pz.
<b>306031</b>	W2	10	40/160	Rotoli	1	<b>22,19</b>



**Piattelli per fissaggio a soffitto**

Codice	Classe	Dado	Conf.	Euro pz.
R <b>306010</b>	W2	1/2"	50	<b>6,28</b>



**Piastra di fissaggio 1"**

Codice	Classe	Dado	Conf.	Euro pz.
<b>306024</b>	W2	1"	20	<b>15,47</b>



**Piastra di fissaggio 1/2"**

Codice	Classe	Dado	Conf.	Euro pz.
<b>306022</b>	W2	1/2"	50	<b>10,41</b>



**Tassello per collare, con perno M 10**

Codice	Classe	Dado	Conf.	Euro pz.
<b>305050</b>	W2	M 10 x 120 mm	50	<b>2,31</b>

R Contattare il Customer Service per tempistiche sulla disponibilità



## Coppelle metalliche per bracciali

Codice	Classe	Ø	Conf.	Conf.	Euro pz.
<b>305504</b>	W2	40	singola	50	<b>4,83</b>
<b>305505</b>	W2	50	singola	50	<b>5,37</b>
<b>305506</b>	W2	63	singola	50	<b>5,21</b>
<b>305507</b>	W2	75	singola	50	<b>6,00</b>
<b>305508</b>	W2	90	singola	50	<b>6,66</b>
<b>305509</b>	W2	110	singola	50	<b>5,91</b>
<b>305510</b>	W2	125	singola	50	<b>6,39</b>
<b>305511</b>	W2	160	singola	50	<b>16,54</b>
<b>305512</b>	W2	200	singola	20	<b>17,76</b>
R <b>983027</b>	W2	250	singola	20	<b>28,15</b>
R <b>983028</b>	W2	315	singola	20	<b>32,85</b>



## Collari zincati per tubi, con filetto gas

Codice	Classe	Ø	Conf.	Euro pz.
<b>305015</b>	W2	50 x 1/2"	10	<b>6,71</b>
<b>305016</b>	W2	63 x 1/2"	10	<b>6,98</b>
<b>305017</b>	W2	75 x 1/2"	10	<b>7,90</b>
<b>305018</b>	W2	90 x 1/2"	10	<b>7,99</b>
<b>305019</b>	W2	110 x 1/2"	10	<b>8,68</b>
<b>305020</b>	W2	125 x 1/2"	10	<b>9,14</b>
<b>305021</b>	W2	160 x 1/2"	10	<b>10,57</b>
<b>305025</b>	W2	200 x 1"	10	<b>31,93</b>
<b>305026</b>	W2	250 x 1"	10	<b>38,46</b>
R <b>305027</b>	W2	315 x 1"	10	<b>45,83</b>



## Collari zincati per tubi, con filetto M 10

Codice	Classe	Ø	Conf.	Euro pz.
<b>305004</b>	W2	40	10	<b>6,13</b>
<b>305005</b>	W2	50	10	<b>6,28</b>
<b>305006</b>	W2	63	10	<b>7,43</b>
<b>305007</b>	W2	75	10	<b>6,89</b>
<b>305008</b>	W2	90	10	<b>7,59</b>
<b>305009</b>	W2	110	10	<b>7,83</b>
<b>305010</b>	W2	125	10	<b>8,60</b>
<b>305011</b>	W2	160	10	<b>9,95</b>

R Contattare il Customer Service per tempistiche sulla disponibilità



**Bracciali di fissaggio con fascetta in gomma antivibrante per Wavin SiTech e Wavin AS**

Codice	Classe	Ø	Conf.	Euro pz.
<b>305607</b>	W2	M10 Ø 75	10	<b>8,60</b>
* <b>305608</b>	W2	M10 Ø 78	10	<b>9,84</b>
<b>305609</b>	W2	M10 Ø 90	10	<b>9,77</b>
<b>305610</b>	W2	M10 Ø 110	10	<b>11,17</b>
<b>305611</b>	W2	M10 Ø 125	10	<b>11,56</b>
* <b>305612</b>	W2	M10 Ø 135	10	<b>13,26</b>
<b>305613</b>	W2	M10 Ø 160	10	<b>14,41</b>

\* Ad esaurimento



**Bracciali in PP per tubazioni per Wavin ED TECH**

Codice	Classe	Ø	Conf.	Euro pz.
<b>*329090</b>	W1	32/40/50	50	<b>6,09</b>
<b>*329091</b>	W1	75/110	50	<b>10,20</b>

\* Sono automaticamente forniti con tassello cod. 329 095 al prezzo di Euro/pz. 1,36





**Guarnizione piatte in EPDM per flange scarico Wavin PE**



	Codice	Classe	de mm	DN	d1 mm	d2 mm	b mm	Conf.	Euro pz.
R	<b>904403</b>	W3	40	32	82	36	3	10	<b>4,05</b>
R	<b>904404</b>	W3	50	40	92	45	3	10	<b>3,80</b>
	<b>904405</b>	W3	63	50	107	56	3	10	<b>4,70</b>
	<b>904406</b>	W3	75	65	127	67	3	10	<b>5,08</b>
	<b>904407</b>	W3	90	80	142	84	3	10	<b>6,47</b>
	<b>904408</b>	W3	110	100	162	103	3	10	<b>7,29</b>
	<b>904462</b>	W3	160	150	218	150	3	10	<b>11,42</b>
R	<b>904463</b>	W3	200	200	273	200	4	10	<b>22,43</b>
	<b>309251</b>	W1	315		378	320	4	10	<b>43,59</b>



**Giunti in PE con filettatura interna per Wavin PE**

	Codice	Classe	Ø	Conf.	Conf.	Euro pz.
*	<b>307043</b>	W2	Ø 50 x 1"		20	<b>60,14</b>
	<b>307049</b>	W2	Ø 50 x 2"		20	<b>71,55</b>

R Contattare il Customer Service per tempistiche sulla disponibilità

\* Ad esaurimento



**Morsetto con anello esterno per Wavin ED TECH e Wavin SiTech**

Codice	Classe	Ø	Ø Impegno	Conf.	Conf.	Euro pz.
<b>800020</b>	W1	40/1" - 1" 1/4			20	<b>4,13</b>



**Morsetti per curve tecniche e manicotti sifone per Wavin ED TECH, Wavin Sitech, Wavin PE e Wavin AS+**

Codice	Classe	Tipo	d	di	Conf.	Euro pz.
<b>308042</b>	W1	(C)	46	1" - 1" 1/4	20	<b>1,66</b>
<b>308044</b>	W1	(D)	46	1" 1/2	20	<b>1,66</b>
<b>308046</b>	W1	(E)	53	1" - 1" 1/4	20	<b>2,08</b>
<b>308048</b>	W1	(F)	53	1" 1/2	20	<b>2,08</b>
<b>R 800004</b>	W1	(G)	67	2"	1	<b>2,89</b>

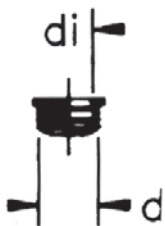

**Pannello fonoassorbente isolante**



Codice	Classe	Descrizione	Spessore	Conf.	Euro pz.
<b>309401</b>	W2	1 m x 2 m	15 mm	1	<b>253,21</b>

**Materassino fonoisolante accoppiato:**

- Poliuretano liscio spess.10 mm
- Massa EPDM spess. 2 mm
- Polietilene reticolato spess. 3 mm

**Caratteristiche tecniche:**

- Peso 5.9 Kg/cm2
- Colore composito Antracite
- Potere fonoisolante 28,5 dB
- Massa Tecnopolimero 5,5 Kg/m2

**Materiale necessario, scarti inclusi**

dim. mm	tubo al m	curve 90°	curve 45°	braghe 45°	braghe 88° 1/2
Ø 63	0,30	0,09	0,05	0,14	0,12
Ø 75	0,35	0,12	0,06	0,17	0,14
Ø 90	0,38	0,17	0,07	0,21	0,17
Ø 110	0,47	0,21	0,09	0,27	0,21
Ø 125	0,50	0,25	0,11	0,32	0,25
Ø 160	0,70	0,35	0,16	0,48	0,39

R Contattare il Customer Service per tempistiche sulla disponibilità



**Collari antifluoco**

Codice	Classe	Ø	Conf.	Euro pz.
R <b>309175</b>	W2	Ø 40	2	<b>140,68</b>
<b>309176</b>	W2	Ø 50	2	<b>146,60</b>
R <b>309177</b>	W2	Ø 63	2	<b>153,80</b>
R <b>309178</b>	W2	Ø 75/78	2	<b>180,81</b>
R <b>309179</b>	W2	Ø 90	2	<b>195,21</b>
<b>309184</b>	W2	Ø 110	2	<b>212,70</b>
<b>309185</b>	W2	Ø 125	2	<b>265,42</b>
* <b>309189</b>	W2	Ø 135	2	<b>253,21</b>
R <b>309190</b>	W2	Ø 160	2	<b>296,54</b>
R <b>309187</b>	W2	Ø 200	1	<b>478,51</b>
R <b>309188</b>	W2	Ø 250	1	<b>611,73</b>



**Collari antifluoco in rotolo**

Codice	Classe	Ø	Conf.	Euro pz.
R <b>309191</b>	W2	Versatile Ø 40/160	1	<b>817,23</b>

Caratteristiche tecniche:

- Fascia in acciaio inox 430/1 da assemblare con guaina intumescente
- Dimensione fascia metallica: 2.500 X 50 mm
- Dimensione guaina intumescente: 6.600 X 50 X 4 mm
- Diametri ottenibili da 40 a 160 mm
- Espansione libera: > 20:1
- Temperatura di attivazione 180°C
- Certificazione Classe EI 120 UNI EN 1366/3 (parete in cartongesso)

Ø tubo mm	Lunghezza fascia mm	Lunghezza guaina mm	N° avvolgimenti	N° collari ottenibili
40	230	310	2	10
50	260	370	2	9
63	300	450	2	8
75/78	350	560	2	7
90	390	620	2	6
110	450	740	2	5
125	520	1310	3	5
135	570	1450	3	4
160	630	1640	3	4

R Contattare il Customer Service per tempistiche sulla disponibilità - \* Ad esaurimento



**Detergente per PE**

Codice	Classe	Quantità	Conf.	Euro p.z.
<b>400030</b>	W2	1 Litro	6	<b>25,87</b>



**Scivolante per guarnizioni**

Codice	Classe	Quantità	Conf.	Euro p.z.
<b>400008</b>	W2	gr 150	50	<b>5,57</b>
<b>400010</b>	W2	gr 250	50	<b>6,71</b>
<b>400012</b>	W2	gr 500	24	<b>11,49</b>

DN	Consumo di scivolante
<b>50</b>	ca. 80 giunzioni: 1 kg
<b>70</b>	ca. 70 giunzioni: 1 kg
<b>80</b>	ca. 65 giunzioni: 1 kg

DN	Consumo di scivolante
<b>100</b>	ca. 60 giunzioni: 1 kg
<b>125</b>	ca. 50 giunzioni: 1 kg
<b>150</b>	ca. 40 giunzioni: 1 kg



Cod. 400 063

**Smussatore per tubazioni ad innesto**

Codice	Classe	Descrizione	Conf.	Euro pz.
<b>400063</b>	W2	Ø 20 - Ø 63	1	<b>61,62</b>
<b>400160</b>	W2	Ø 25 - Ø 200	1	<b>415,72</b>



Cod. 400 160



# Wavin EMÙ

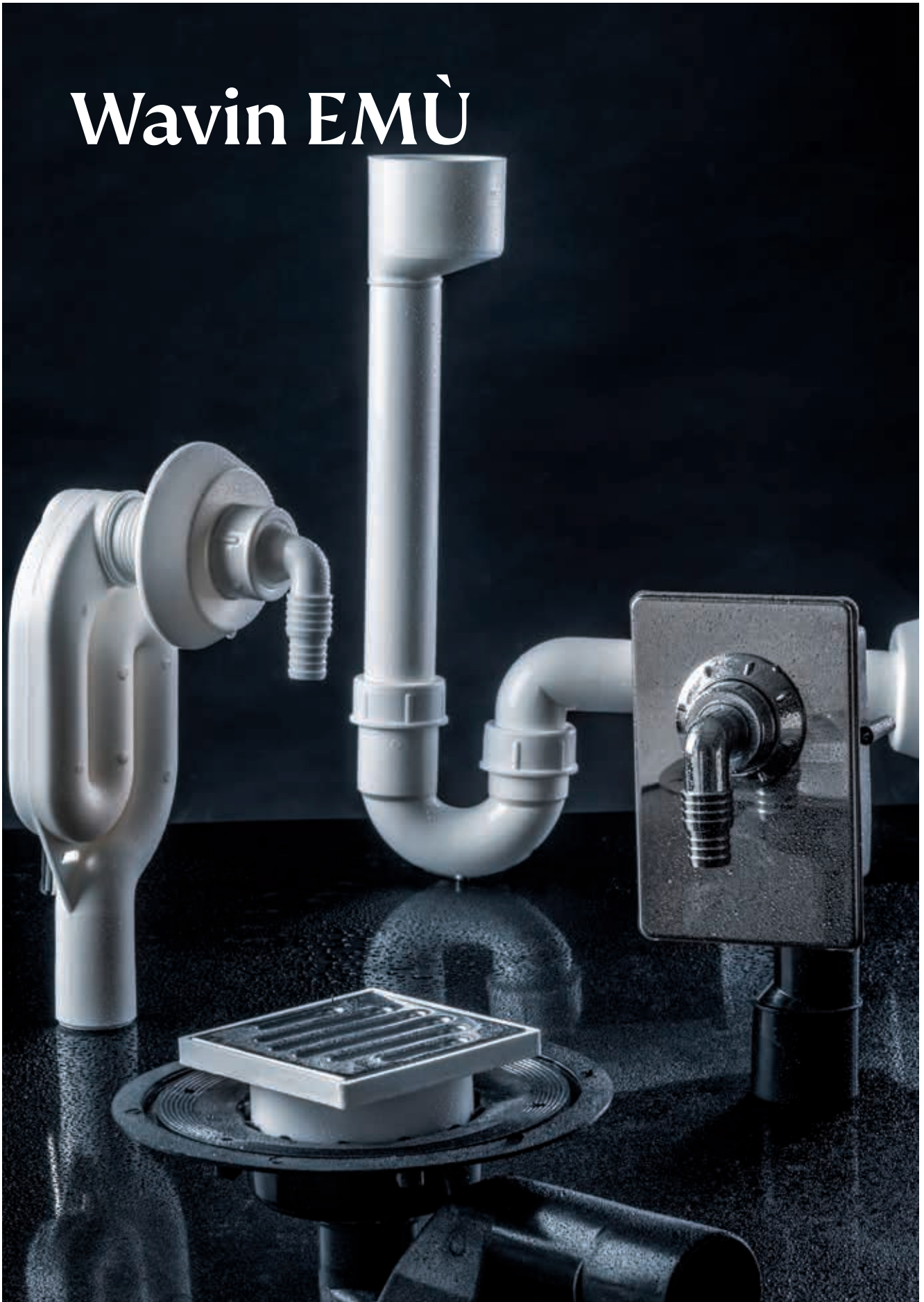

## DESCRIZIONE SIFONI EMÙ

Ad integrazione dei sistemi di scarico, Wavin offre l'ampia gamma di sifoni Wavin EMÙ per qualsiasi tipologia di scarico. Sono disponibili sifoni lavabo, bidet e lavelli, scarichi vasca, doccia, pozzetti a pavimento e scarichi terrazzi, attacchi WC, aeratori, scarichi lavatrice e condensa, per soddisfare qualsiasi tipologia di installazione.

I sifoni Wavin EMÙ rispondono ampiamenti ai requisiti fondamentali per garantire funzionalità ed igiene negli impianti di scarico, ovvero evitare l'infiltrazione di cattivi odori e proteggere l'ambiente da eventuale riflusso dell'acqua di scarico, nel rispetto delle norme di riferimento EN 274 e EN 1253.

## CARATTERISTICHE PRINCIPALI

L'affidabilità, la facilità di montaggio e la funzionalità sono le caratteristiche qualitative peculiari dei sifoni Wavin EMÙ. Inoltre la scelta dei materiali utilizzati, PP e PE, per la realizzazione dei sifoni Wavin EMÙ garantiscono un'ottima resistenza alle alte temperature, ai grassi e prodotti chimici, le pareti lisce proteggono inoltre da incrostazioni (effetto autopulente).

## ISPEZIONABILITÀ

Il sifone non solo deve garantire la corretta funzionalità evitando esalazioni fastidiose e reflussi dell'acqua di scarico, ma deve offrire anche una facile ispezione e pulizia. I sifoni Wavin EMÙ sono autopulenti e nelle situazioni di possibile intasamento sono facilmente ispezionabili per garantire una facile manutenzione e quindi una lunga durata nel tempo.

## TAPPO IDRAULICO

Una corretta dimensione della colonna d'acqua evita le esalazioni provenienti dagli scarichi, il mantenimento dell'altezza minima di colonna d'acqua di almeno 50 mm costituisce il presupposto per la corretta funzionalità del sifone.

## DISPOSITIVO ANTIRISUCCHIO

I sifoni lavello Wavin EMÙ presentano un attacco indipendente per lo scarico lavatrice e lavastoviglie con dispositivo antirisucchio. Questo dispositivo è fondamentale poiché impedisce alla pressione di scarico della lavatrice o della lavastoviglie di svuotare il sifone lavello.







**Colonna scarico vasca**

- Tubo di troppo pieno a "L" rigido e terminale flessibile
- Sistema di apertura/chiusura con movimento a cremagliera
- Piletta in acciaio inox
- Interasse 55 mm
- Completa di sifone ribassato preassemblato e curva tecnica 40/50
- Finiture cromate

Codice	Classe	Descrizione	Scat.	Conf.	Euro pz.
<b>M600</b>	1D		10	1	<b>91,15</b>
<b>Ricambi</b>					
R <b>M6030</b>	1D	Tappo per colonna		1	<b>12,45</b>



**Sifoni scarico vasca**

- Con dado ottone da 1" 1/2
- PE HD nero saldabile
  - Dispositivo antirisucchio
  - Portata = 2000 l/h

Codice	Classe	Descrizione	Conf.	Euro pz.
<b>M802</b>	1D		10	<b>16,16</b>



**A snodo con dado ottone da 1" 1/4**

- PE HD nero saldabile
- Rotazioni: orizzontale ~ 280° - verticale ~ 14°
- Autopulente
- Doppia guarnizione di tenuta
- Snodo DN 40/50
- Portata = 2000 l/h

Codice	Classe	Descrizione	Conf.	Euro pz.
R <b>M852</b>	1D		10	<b>22,02</b>



**A snodo con dado ottone da 1" 1/2**

- PE HD nero saldabile
- Rotazioni: orizzontale ~ 280° - verticale ~ 14°
- Autopulente
- Doppia guarnizione di tenuta
- Snodo DN 40/50
- Portata = 2000 l/h

Codice	Classe	Descrizione	Conf.	Euro pz.
<b>M853</b>	1D		10	<b>21,65</b>

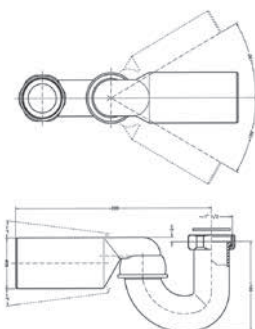

R Contattare il Customer Service per tempistiche sulla disponibilità



**Pilette a pavimento**

**Minipiletta con uscita DN 40/50**

- PE HD nero saldabile
- Dispositivo antirisucchio regolabile

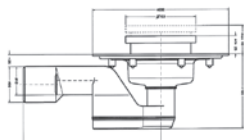

Codice	Classe	Descrizione	Conf.	Euro pz.
<b>M611</b>	1D		20	<b>37,47</b>
<b>Ricambi</b>				
R <b>M6111</b>	1D	Griglia inox 100x100	5	<b>5,60</b>
R <b>M6110</b>	1D	Filtro + Portafiltro 100x100	1	<b>10,41</b>



**Minipiletta a snodo con uscita DN 40/50**

- PE HD nero saldabile
- Autopulente
- Doppia guarnizione di tenuta

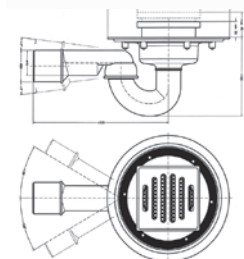

Codice	Classe	Descrizione	Conf.	Euro pz.
<b>M716/40</b>	1D		20	<b>42,65</b>
<b>Ricambi</b>				
R <b>M6111</b>	1D	Griglia inox 100x100	5	<b>5,60</b>
R <b>M6110</b>	1D	Filtro + Portafiltro 100x100	1	<b>10,41</b>



**Maxipiletta**

- PE HD nero saldabile
- Regolabile

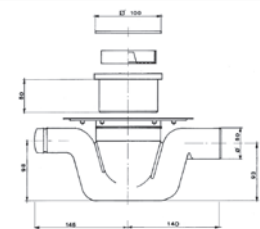

Codice	Classe	Descrizione	Conf.	Euro pz.
<b>M713</b>	1D		1	<b>62,14</b>
<b>Ricambi</b>				
R <b>M6111</b>	1D	Griglia inox 100x100	5	<b>5,60</b>
R <b>M6110</b>	1D	Filtro + Portafiltro 100x100	1	<b>10,41</b>



**Accessori**

**Prolunga Polipropilene bianco**

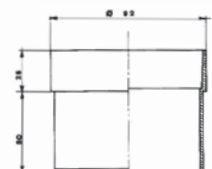

Codice	Classe	Descrizione	Scat.	Conf.	Euro pz.
<b>M610</b>	1D		20	5	<b>5,48</b>

R Contattare il Customer Service per tempistiche sulla disponibilita

**Sifoni per doccia**



**A snodo DE 90**

- PE HD nero saldabile
- Rotazioni: orizzontale ~ 270° - verticale ~ 10°
- Autopulente
- Doppia guarnizione di tenuta
- Snodo DN 40/50

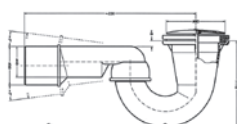

Codice	Classe	Descrizione	Conf.	Euro pz.
<b>M655</b>	1D		5	<b>20,20</b>

**Ricambi**

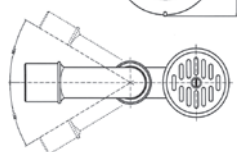

R <b>M6000</b>	1D	Griglia per sifone doccia + vite + guarnizione	1	<b>10,64</b>
----------------	----	--	---	--------------

**A snodo DE 90 con attacco universale**

- Polipropilene bianco
- Rotazioni: orizzontale ~ 270° - verticale ~ 10°
- Autopulente
- Doppia guarnizione di tenuta

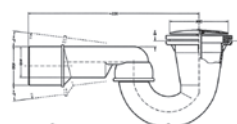

Codice	Classe	Descrizione	Conf.	Euro pz.
<b>M692</b>	1D		5	<b>21,45</b>

**Ricambi**

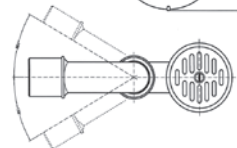

R <b>M6000</b>	1D	Griglia per sifone doccia + vite + guarnizione	1	<b>10,64</b>
----------------	----	--	---	--------------

R <b>M6001</b>	1D	Ghiera bianca 1"1/2 + guarnizione conica 1"1/2 + rondella premiguarnizione 1"1/2	1	<b>2,45</b>
----------------	----	--	---	-------------

R Contattare il Customer Service per tempistiche sulla disponibilita



**Pilette sifoidi**

Per doccia DN 80 con attacco universale

- Polipropilene bianco
- Piattello cromato Ø 86

Codice	Classe	Descrizione	Conf.	Euro pz.
<b>M717</b>	1D		1	<b>30,69</b>

**Ricambi**

R <b>M7172</b>	1D	Griglia cromata	5	<b>3,43</b>
R <b>M6001</b>	1D	Ghiera bianca 1"1/2 + guarnizione conica 1"1/2 + rondella premiguarnizione 1"1/2	1	<b>2,45</b>

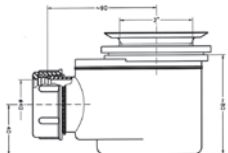

Per doccia DN 80 con deflusso laterale e attacco universale

- Polipropilene bianco
- Cestello antirisucchio
- Piattello cromato Ø 86

Codice	Classe	Descrizione	Conf.	Euro pz.
<b>M871</b>	1D		1	<b>29,06</b>

**Ricambi**

R <b>M8551</b>	1D	Calotta di deflusso cromata Ø86	1	<b>12,92</b>
R <b>M6001</b>	1D	Ghiera bianca 1"1/2 + guarnizione conica 1"1/2 + rondella premiguarnizione 1"1/2	1	<b>2,45</b>

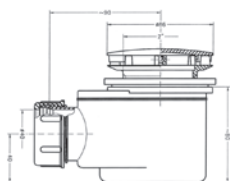

Per doccia DN90 con deflusso laterale e attacco universale

- Polipropilene caricato mineralmente bianco
- Ghiera in poliammide
- Guarnizione in SBR
- Piattello cromato Ø 120

Codice	Classe	Descrizione	Conf.	Euro pz.
<b>M875</b>	1D	Piletta doccia alta (battente 50 mm)	1	<b>53,74</b>
<b>M877</b>	1D	Piletta doccia ribassata (battente 30 mm)	1	<b>53,74</b>

**Ricambi**

R <b>M8731</b>	1D	Calotta di deflusso cromata Ø120	1	<b>16,03</b>
R <b>M6001</b>	1D	Ghiera bianca 1"1/2 + guarnizione conica 1"1/2 + rondella premiguarnizione 1"1/2	1	<b>2,45</b>

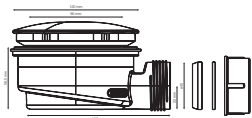
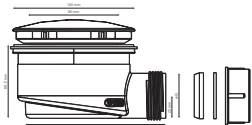

R Contattare il Customer Service per tempistiche sulla disponibilita



**Canalina per doccia filo pavimento - Sifone orientabile**  
**Completa di griglia, guaina isolante preformata e nastro butilico bi-adesivo**



Codice	Classe	Descrizione	Conf.	Euro pz.
* <b>609 905</b>	1D	Kit canalina per doccia in PP 600 mm	1	<b>501,40</b>
* <b>609 906</b>	1D	Kit canalina per doccia in PP 700 mm	1	<b>527,11</b>
* <b>609 907</b>	1D	Kit canalina per doccia in PP 800 mm	1	<b>565,95</b>



**Pozzetti a pavimento**  
**DN 100 per doccia con telo in PVC**  
 • PE HD nero saldabile  
 • Uscita DN 40/50

Codice	Classe	Descrizione	Conf.	Euro pz.
<b>M650</b>	1D	con telo PVC 140x140 cm	1	<b>149,55</b>
<b>M651</b>	1D	con telo PVC 200x200	1	<b>219,25</b>



**In PE HD a 4 vie con griglia sifonato**  
 • PE HD nero saldabile  
 • Valvola antiritorno regolabile H 53 mm  
 • 3 ingressi DN 40 1 uscita DN 50 - Ingressi da forare

Codice	Classe	Descrizione	Conf.	Euro pz.
<b>M613</b>	1D		1	<b>46,42</b>
<b>Ricambi</b>				
<b>R M6111</b>	1D	Griglia inox 100x100	5	<b>5,60</b>

R Contattare il Customer Service per tempistiche sulla disponibilita - \* Ad esaurimento



**In PP a 4 vie con bicchieri con griglia sifonato**

- Polipropilene grigio
- Valvola antiritorno regolabile H 53 mm
- 3 ingressi DN 40 1 uscita DN 50 - Ingressi da forare
- Guarnizioni a labbro inserite

Codice	Classe	Descrizione	Conf.	Euro pz.
<b>M615</b>	1D		1	<b>51,51</b>
<b>Ricambi</b>				
<b>R M6111</b>	1D	Griglia inox 100x100	5	<b>5,60</b>



**Alto in PE HD a 4 vie**

- PE HD nero saldabile
- 3 ingressi DN 40 1 uscita DN 50 - Ingressi da forare
- Portata = 2880 l/h

Codice	Classe	Descrizione	Conf.	Euro pz.
<b>M618</b>	1D		5	<b>17,81</b>

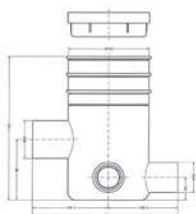

R Contattare il Customer Service per tempistiche sulla disponibilità \* Ad esaurimento



**In PP a 4 vie con bicchieri**

- Polipropilene grigio
- 3 ingressi DN 40 1 uscita DN 50 - Ingressi da forare
- Guarnizioni a labbro inserite

Codice	Classe	Descrizione	Conf.	Euro pz.
<b>M627</b>	1D		5	<b>16,11</b>



**Alto in PP a 4 vie con bicchieri**

- Polipropilene grigio
- 3 ingressi DN 40 1 uscita DN 50 - Ingressi da forare
- Guarnizioni a labbro inserite
- Portata = 2880 l/h

Codice	Classe	Descrizione	Conf.	Euro pz.
<b>M643</b>	1D		20	<b>22,66</b>

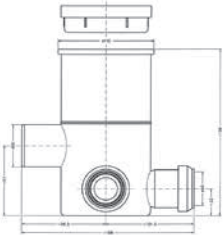



**In PP universale a 4 vie con bicchieri uscita DN 40**

- Polipropilene grigio
- 3 ingressi DN 40 1 uscita DN 40 - Ingressi da forare
- Guarnizioni inserite
- Portata = 2880 l/h

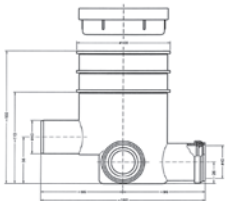

Codice	Classe	Descrizione	Conf.	Euro pz.
<b>M682</b>	1D		20	<b>13,91</b>



**In PP universale a 4 vie con bicchieri uscita DN 50**

- Polipropilene grigio
- 3 ingressi DN 40 1 uscita DN 50 - Ingressi da forare
- Guarnizioni inserite
- Portata = 2880 l/h

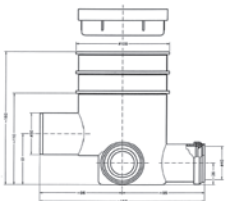

Codice	Classe	Descrizione	Conf.	Euro pz.
<b>M699</b>	1D		20	<b>11,83</b>





**Tappi**

Chiuso per pozzetto DN 100

- Poliammide
- Chiusura ad espansione

Codice	Classe	Descrizione	Conf.	Euro pz.
<b>M620</b>	1D		10	<b>12,92</b>



**Grigliato per pozzetto DN 100**

- Poliammide e polipropilene
- Chiusura ad espansione

Codice	Classe	Descrizione	Conf.	Euro pz.
<b>M619</b>	1D		10	<b>16,81</b>



**Completo per impermeabilizzazione**

- Flange in acciaio
- Telo in PVC s= 1 mm

Codice	Classe	Descrizione	Conf.	Euro pz.
<b>M653</b>	1D	Con telo 140x140 cm	1	<b>109,07</b>

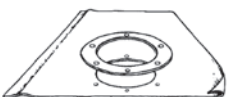

**Ricambi**

<b>R M6935</b>	1D	Kit Flangia acciaio + guarnizione e viti	1	<b>32,75</b>
----------------	----	--	---	--------------

N.B.: da utilizzare solo per articoli EMÙ M611 - M716/40 - M713 - M614 - M695 - M697



**Diritto DN 50/75/110 con griglia 123x123**

(HL 310/N)

- PE HD saldabile
- Capacità di scarico 40 l/min.

Codice	Classe	Descrizione	Conf.	Euro pz.
<b>609 802</b>	1D		1	<b>87,44</b>



R Contattare il Customer Service per tempistiche sulla disponibilita



**Tubi di cacciata**

Ad incasso regolabile per il collegamento della cassetta alta al vaso

- Polipropilene grigio
- Attacco superiore con rotazione 90° ÷ 60°
- Regolazione inferiore a cannocchiale

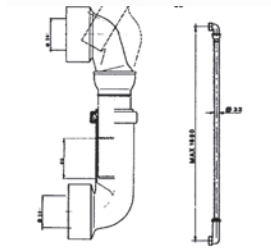

Codice	Classe	Descrizione	Conf.	Euro pz.
<b>M644</b>	1D		50	<b>21,00</b>
<b>Ricambi</b>				

<b>R M6003</b>	1D	Kit ricambio tubi di cacciata composto da: Gomito di regolazione No. 2 Morsetti per vaso No. 2 Guarnizioni fustellate	1	<b>12,81</b>
----------------	----	--	---	--------------



Regolabile per passo rapido e flussometro da 3/4"

- Polipropilene grigio
- Guarnizioni in eva

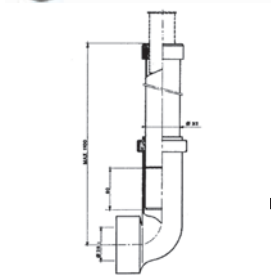

Codice	Classe	Descrizione	Conf.	Euro pz.
<b>M673</b>	1D		25	<b>16,89</b>
<b>Ricambi</b>				

<b>R M6003</b>	1D	Kit ricambio tubi di cacciata composto da: Gomito di regolazione No. 2 Morsetti per vaso No. 2 Guarnizioni fustellate	1	<b>12,81</b>
----------------	----	--	---	--------------



**Guarnizioni**

WC concentrica

- Eva bianco

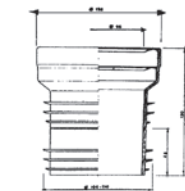

Codice	Classe	Descrizione	Scat.	Conf.	Euro pz.
<b>M647</b>	1D		20	1	<b>8,97</b>



WC concentrica

- Eva bianco
- Eccentricità 18 mm

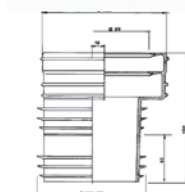

Codice	Classe	Descrizione	Scat.	Conf.	Euro pz.
<b>M648</b>	1D		20	1	<b>9,67</b>

**R** Contattare il Customer Service per tempistiche sulla disponibilita



**Rosoni**

• Polipropilene bianco



Codice	Classe	Descrizione	Conf.	Euro pz.
<b>M675</b>	1D		20	<b>5,48</b>



Per WC DN 90 (HL 7EL/90 WE)



Codice	Classe	Descrizione	Conf.	Euro pz.
<b>609782</b>	1D		10	<b>13,61</b>

Per WC apribile DN 110 (HL7 WE)



Codice	Classe	Descrizione	Conf.	Euro pz.
<b>306051</b>	1D		1	<b>24,41</b>



**Bocchettoni vaso parete**

DN 110 (HL 222/1)

Codice	Classe	Descrizione	Conf.	Euro pz.
<b>609766</b>	1D	DN 110 (HL222/1)	10	<b>35,82</b>
<b>609767</b>	1D	DN 90 (HL 222/90)	10	<b>35,13</b>



**Tubi allacciamento WC**



Codice	Classe	Descrizione	Conf.	Euro pz.
<b>M749</b>	1D	Ø 90x25 cm	20	<b>11,79</b>
<b>R M750</b>	1D	Ø 100x20 cm	24	<b>11,79</b>
<b>R M751</b>	1D	Ø 100x40 cm	13	<b>13,38</b>
<b>M752</b>	1D	Ø 110x40 cm	10	<b>15,38</b>

R Contattare il Customer Service per tempistiche sulla disponibilita



**Raccordi WC concentrici (con guarnizione e tappo) HTSK**

Codice	Classe	d1	i	z1	z2	L	Pallet	Conf.	Euro pz.
<b>243 034D</b>	A2	90				180	240	10	<b>24,75</b>
<b>243 032D</b>	A2	110				350	120	10	<b>31,85</b>

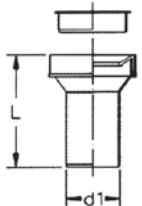

**Raccordo WC eccentrico (con guarnizione e tappo) HTSK**

Codice	Classe	d1	Ds Disassamento	L	Pallet	Conf.	Euro pz.
<b>243036D</b>	A2	110	12,5	180	240	10	<b>25,81</b>

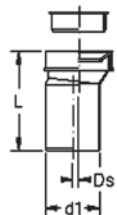

**Connettore estensibile WC**

Codice	Classe	Descrizione	Conf.	Euro pz.
<b>R M710</b>	1D	Estensibile 290/590 mm	15	<b>15,72</b>



**Valvole antiriflusso**

**Automatica DN 50 (HL 4)**

• Possibilità di montaggio orizzontale e verticale

Codice	Classe	Descrizione	Conf.	Euro pz.
<b>609851</b>	1D		10	<b>110,81</b>



**Automatica DN 110 (HL 710)**

Codice	Classe	Descrizione	Conf.	Euro pz.
<b>609852</b>	1D		1	<b>522,99</b>



R Contattare il Customer Service per tempistiche sulla disponibilità



**Aeratore**

Aeratore conforme alla legge EN 12380-1 con filtro anti-insetti estraibile (facile da pulire), membrana in gomma e doppio corpo isolante (HL 900N)

- Materiale: PP
- Prestazione: 37 L/sec
- Peso: 0,485 Kg
- Profondità di incasso: 130 mm



Codice	Classe	DN	Conf.	Euro pz.
<b>M918</b>	1D	110/75/50	1	<b>122,35</b>



**Accessorio per M918**

Riduttore DN 75/90 (HL 990)

Codice	Classe	DN	Conf.	Euro pz.
<b>R M9181</b>	1D	75/90	1	<b>41,38</b>

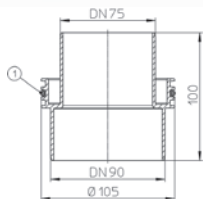

**Aeratore per lavabo e bidet**

Aeratore attacco 1" con raccordo T (HL 902T)

- Materiale: PP
- Peso: 0,08 Kg
- Profondità: 44 mm

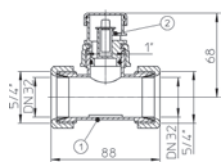

**M919**

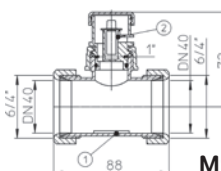

**M920**

Codice	Classe	DN	Conf.	Euro pz.
<b>R M919</b>	1D	Ø 32 1" 1/4	1	<b>80,96</b>
<b>R M920</b>	1D	Ø 40 1" 1/2	1	<b>80,96</b>

**Esalatori**

DN 110 (HL 810)



Codice	Classe	DN	Conf.	Euro pz.
<b>609892</b>	1D	110	10	<b>79,38</b>

R Contattare il Customer Service per tempistiche sulla disponibilità



**Scarichi per terrazzi**

**Dritto per terrazzi DN 50**

- PE HD nero saldabile
- Regolabile H 25 mm

Codice	Classe	Descrizione	Scat.	Conf.	Euro pz.
<b>M695</b>	1D		40	1	<b>37,36</b>

**Ricambi**

R <b>M6111</b>	1D	Griglia inox 100x100		5	<b>5,60</b>
R <b>M6110</b>	1D	Filtro + Portafiltro 100x100		1	<b>10,41</b>

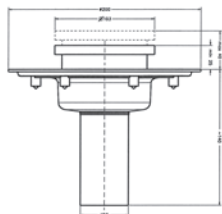

**Scarico orizzontale per balconi e terrazzi DN 40/50 (HL90)**

- PE HD nero saldabile
- Con flangia isolante, prolunga accordabile 10-72 mm/ 100x100 mm, cestello raccoglisporco e griglia in acciaio 94x94 mm. profondità d'incasso 57 mm.
- Prestazioni 0,56 L/sec.

Codice	Classe	Descrizione	Conf.	Euro pz.
<b>609731</b>	1D	DN 40/50	1	<b>72,31</b>

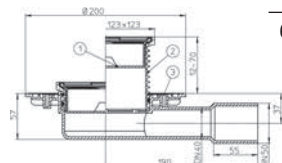

**Curvo per terrazzi DN 50**

- PE HD nero saldabile
- Regolabile H 25 mm

Codice	Classe	Descrizione	Scat.	Conf.	Euro pz.
<b>M697</b>	1D		20	1	<b>43,11</b>

**Ricambi**

R <b>M6111</b>	1D	Griglia inox 100x100		5	<b>5,60</b>
R <b>M6110</b>	1D	Filtro + Portafiltro 100x100		1	<b>10,41</b>

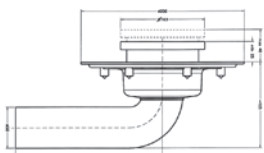

R Contattare il Customer Service per tempistiche sulla disponibilita



**Sifoni lavatrice**

**Ad incasso con rosone e portagomma bianchi**

- Poliolefina bianca
- Portata = 700 l/h

Codice	Classe	Descrizione	Conf.	Euro pz.
<b>M715</b>	1D		20	<b>16,25</b>

**Ricambi**

<b>R M6004</b>	1D	Kit di ricambio composto da: Rosone bianco 1"1/4 Portagomma bianco 1"1/4 Ghiera bianca 1"1/4 O-ring	1	<b>7,62</b>
----------------	----	---	---	-------------

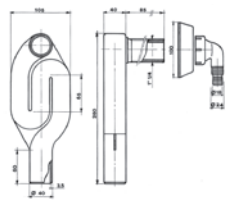

**Ad incasso con rosone e portagomma cromati**

- PE HD nero saldabile
- Ispezione da 1"
- Portata = 700 l/h

Codice	Classe	Descrizione	Conf.	Euro pz.
<b>M623</b>	1D		5	<b>18,99</b>

**Ricambi**

<b>R M6234</b>	1D	Piastra inox 110x160	5	<b>4,92</b>
<b>R M6005</b>	1D	Kit di ricambio composto da: Rosone cromato 1" Ghiera cromata 1" Portagomma cromato 1" O-ring	1	<b>8,40</b>
<b>R M6025</b>	1D	Tappo filettato 1" + guarnizione piana 1"	10	<b>1,84</b>

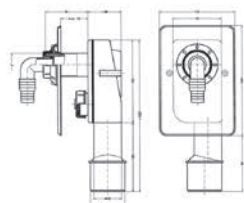

**Ad incasso "Star" in PE HD con rosone e portagomma bianchi**

- PE HD nero saldabile
- Ispezione da 1"
- Portata = 700 l/h

Codice	Classe	Descrizione	Conf.	Euro pz.
<b>M723</b>	1D		5	<b>16,12</b>

**Ricambi**

<b>R M6006</b>	1D	Kit di ricambio composto da: Piastra bianca ABS Rosone bianco 1" Ghiera bianca 1" Portagomma bianco 1" O-ring	1	<b>7,94</b>
<b>R M6025</b>	1D	Tappo filettato 1" + guarnizione piana 1"	10	<b>1,84</b>

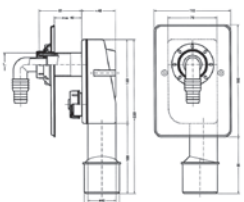

**R** Contattare il Customer Service per tempistiche sulla disponibilita





**Scarichi lavatrice incasso**

- PE HD nero saldabile
- Ispezione da 1" dispositivo antiodore

Codice	Classe	Descrizione	Conf.	Euro pz.
<b>M624</b>	1D	Con piastra INOX - Rosone e portagomma cromati	10	<b>16,78</b>

**Ricambi**

<b>R M6234</b>	1D	Piastra inox 110x160	5	<b>4,92</b>
<b>R M6005</b>	1D	Kit di ricambio composto da: Rosone cromato 1" - Ghiera cromata 1" Portagomma cromato 1" - O-ring	1	<b>8,40</b>
<b>R M6025</b>	1D	Tappo filettato 1" + guarnizione piana 1"	10	<b>1,84</b>

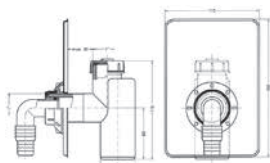

Codice	Classe	Descrizione	Conf.	Euro pz.
--------	--------	-------------	-------	----------

<b>M724</b>	1D	Con piastra ABS - Rosone e portagomma bianchi	10	<b>11,42</b>
-------------	----	---	----	--------------

**Ricambi**

<b>R M6006</b>	1D	Kit di ricambio composto da: Piastra bianca ABS Rosone bianco 1" - Ghiera bianca 1" Portagomma bianco 1" - O-ring	1	<b>7,94</b>
<b>R M6025</b>	1D	Tappo filettato 1" + guarnizione piana 1"	10	<b>1,84</b>



**Scarichi lavatrice**

**Esterno**

- Scarico in polipropilene bianco
- Copertura in ABS bianco
- Ispezione da 1"

Codice	Classe	Descrizione	Conf.	Euro pz.
--------	--------	-------------	-------	----------

<b>M684</b>	1D		10	<b>10,23</b>
-------------	----	--	----	--------------

**Ricambi**

<b>R M6025</b>	1D	Tappo filettato 1" + guarnizione piana 1"	10	<b>1,84</b>
----------------	----	---	----	-------------

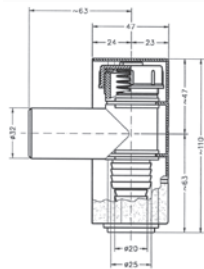

**Art. M623 - M723 - M624 e M724 da 1"**

- Polipropilene bianco

Codice	Classe	Descrizione	Conf.	Euro pz.
--------	--------	-------------	-------	----------

<b>M719</b>	1D		10	<b>3,53</b>
-------------	----	--	----	-------------

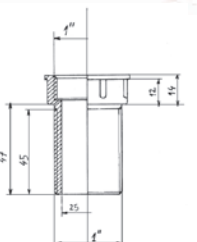

**R** Contattare il Customer Service per tempistiche sulla disponibilita



**Sifoni scarico condensa**

**Incasso**

• Polipropilene bianco

Codice	Classe	Descrizione	Conf.	Euro pz.
<b>M721</b>	1D		10	<b>24,56</b>

**Ricambi**

R <b>M6007</b>	1D	Tappo filettato 1" + guarnizione piana 1" + morsetto 47x32	1	<b>4,74</b>
----------------	----	--	---	-------------

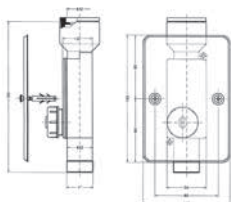

**Esterno**

• Polipropilene bianco

Codice	Classe	Descrizione	Conf.	Euro pz.
<b>M722</b>	1D		10	<b>21,30</b>

**Ricambi**

R <b>M6008</b>	1D	Kit di ricambio composto da: Ghiera bianca 1" Portagomma diritto Morsetto 47x16/20 Guarnizione 1"	1	<b>4,74</b>
----------------	----	---	---	-------------

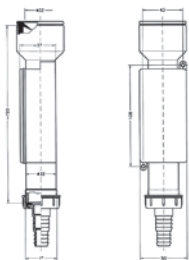

R Contattare il Customer Service per tempistiche sulla disponibilità



**Sifoni per lavabo**

**A "S"**

- Polipropilene bianco
- Portata = 2000 l/h

Codice	Classe	Descrizione	Scat.	Conf.	Euro pz.
<b>M114</b>	1D	Da 1" 1/4 x 40	50	1	<b>11,90</b>

**Ricambi**

<b>R M6024</b>	1D	Rosone+ curva 90° Ø40		1	<b>6,87</b>
----------------	----	-----------------------	--	---	-------------

<b>R M6009</b>	1D	Kit ricambio m114 composto da: No. 2 Ghiera bianca 1"1/2 No. 2 Guarnizione conica 1"1/2 No. 2 Anello premiguarnizione 1"1/2 No. 1 Guarnizione piana 1"1/4		1	<b>4,88</b>
----------------	----	---	--	---	-------------

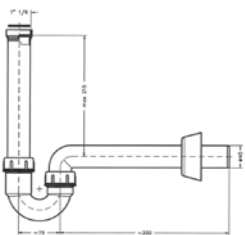

**A "S" Salvaspazio**

- Polipropilene bianco
- Portata = 2000 l/h

Codice	Classe	Descrizione	Scat.	Conf.	Euro pz.
<b>M116</b>	1D	Da 1" 1/4 x 40	10	1	<b>16,54</b>

**Ricambi**

<b>R M6024</b>	1D	Rosone+ curva 90° Ø40		1	<b>6,87</b>
----------------	----	-----------------------	--	---	-------------

<b>R M6021</b>	1D	Kit di ricambio composto da: No. 3 Ghiera bianca 1"1/2 No. 3 Guarnizione conica 1"1/2 No. 3 Anello premiguarnizione 1"1/2 No. 2 Guarnizione piana 1"1/2		1	<b>5,65</b>
----------------	----	---	--	---	-------------



**Sifoni per bidet**

**A "S" eccentrico per bidet da 1" 1/4 x 40**

- Polipropilene bianco
- Portata = 2000 l/h

Codice	Classe	Descrizione	Scat.	Conf.	Euro pz.
<b>M115</b>	1D		20	1	<b>12,06</b>

**Ricambi**

<b>R M6016</b>	1D	Rosone + curva 45° sifone bidet		1	<b>7,80</b>
----------------	----	---------------------------------	--	---	-------------

<b>R M6015</b>	1D	Kit ricambio composto da: No. 2 Ghiera bianca 1"1/4 No. 2 Guarnizione conica 1"1/4 No. 2 Anello premiguarnizione 1"1/4 No. 1 Ghiera bianca fil. Gas 1"1/4 No. 1 Guarnizione piana 1"1/4		1	<b>4,88</b>
----------------	----	--	--	---	-------------

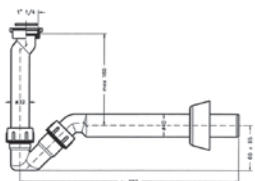

**R** Contattare il Customer Service per tempistiche sulla disponibilità



**Sifoni per bidet e orinatoi**

**A "S" centrato per bidet da 1" 1/4 x 40**

• Polipropilene bianco

Codice	Classe	Descrizione	Scvat.	Conf.	Euro pz.
<b>M117</b>	1D		40	1	<b>11,68</b>

**Ricambi**

R <b>M6017</b>	1D	Rosone + curva 90° Ø32/40			<b>7,80</b>
R <b>M6015</b>	1D	Kit ricambio composto da: No. 2 Ghiera bianca 1"1/4 No. 2 Guarnizione conica 1"1/4 No. 2 Anello premiguarnizione 1"1/4 No. 1 Ghiera bianca fil. Gas 1"1/4 No. 1 Guarnizione piana 1"1/4		1	<b>4,88</b>

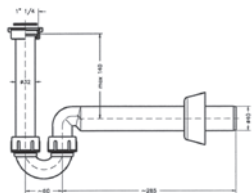

**A "S" per orinatoio**

• Polipropilene bianco

Codice	Classe	Descrizione	Scat.	Conf.	Euro pz.
<b>M118</b>	1D	DN 40	10	1	<b>28,78</b>

**Ricambi**

R <b>M6024</b>	1D	Rosone+ curva 90° Ø40		1	<b>6,87</b>
R <b>M6018</b>	1D	Kit ricambio composto da: Ghiera bianca 1" 1/2 Guarnizione conica 1" 1/2 Anello premiguarnizione 1" 1/2 Morsetto		1	<b>9,16</b>

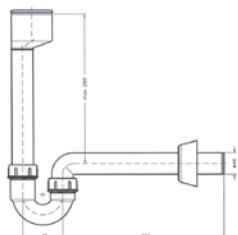

R Contattare il Customer Service per tempistiche sulla disponibilita

Sifoni in ottone per lavabo design



Codice	Classe	Descrizione	Scat.	Conf.	Euro p.z.
<b>M900</b>	1D	1" 1/4	20	1	<b>78,58</b>
<b>R M910</b>	1D	Quadrato 1" 1/4	20	1	<b>86,42</b>



Pilette Click-Clack



Codice	Classe	Descrizione	Scat.	Conf.	Euro p.z.
<b>M915</b>	1D	1/4 universale	48	1	<b>39,27</b>
<b>R M916</b>	1D	1" 1/4 con troppo pieno	48	1	<b>39,27</b>

Sifoni per lavelli



A "S" 1 bacinella  
 • Polipropilene bianco  
 • Portata = 2800 l/h

Codice	Classe	Descrizione	Scat.	Conf.	Euro p.z.
<b>M125</b>	1D	1" 1/2 x 40	10	1	<b>13,16</b>

Ricambi

<b>R M1251</b>	1D	Ghiera filetto gas 1" 1/2		10	<b>1,60</b>
<b>R M6024</b>	1D	Rosone+ curva 90° Ø40		1	<b>6,87</b>
<b>R M6019</b>	1D	Kit ricambio composto da: No. 2 Ghiera bianca 1"1/2 No. 2 Guarnizione conica 1"1/2 No. 2 Anello premiguarnizione 1"1/2 No. 1 Guarnizione piana 1"1/2		1	<b>2,74</b>

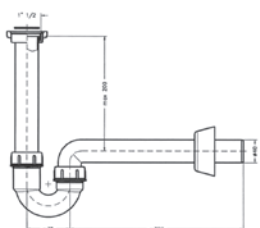

**R** Contattare il Customer Service per tempistiche sulla disponibilità

**Sifoni per lavelli**



**A "S" 1 bacinella con attacco lavatrice e dispositivo antirisucchio**

- Polipropilene bianco
- Possibilità di tappare l'attacco lavatrice se non utilizzato
- Portata = 2800 l/h

Codice	Classe	Descrizione	Scat.	Conf.	Euro pz.
<b>M126</b>	1D	1" 1/2 x 40	20	1	<b>15,27</b>

**Ricambi**

<b>R M6024</b>	1D	Rosone+ curva 90° Ø40		1	<b>6,87</b>
----------------	----	-----------------------	--	---	-------------

<b>R M6019</b>	1D	Kit ricambio composto da: No. 2 Ghiera bianca 1"1/2 No. 2 Guarnizione conica 1"1/2 No. 2 Anello premiguarnizione 1"1/2 No. 1 Guarnizione piana 1"1/2		1	<b>2,74</b>
----------------	----	--	--	---	-------------

<b>R M6020</b>	1D	Kit Ricambio Portagomma + Dispositivo Antirisucchio composto da: Ghiera bianca 1"1/4 Portagomma bianca 1"1/4 Dispositivo antirisucchio Tappo dispositivo antirisucchio Guarnizione piana 29,5X37,5		1	<b>5,34</b>
----------------	----	---	--	---	-------------

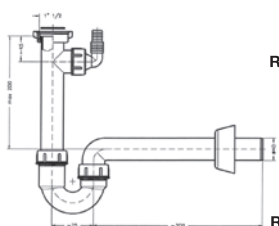

**A "S" 2 bacinelle con attacco lavatrice e dispositivo antirisucchio**

- Polipropilene bianco
- Possibilità di tappare l'attacco lavatrice se non utilizzato
- Portata = 2800 l/h



Codice	Classe	Descrizione	Scat.	Conf.	Euro pz.
<b>M136</b>	1D	1" 1/2 x 40	20	1	<b>19,38</b>

**Ricambi**

<b>R M6024</b>	1D	Rosone+ curva 90° Ø40		1	<b>6,87</b>
----------------	----	-----------------------	--	---	-------------

<b>R M6021</b>	1D	Kit di ricambio composto da: No. 3 Ghiera bianca 1"1/2 No. 3 Guarnizione conica 1"1/2 No. 3 Anello premiguarnizione 1"1/2 No. 2 Guarnizione piana 1"1/2		1	<b>5,65</b>
----------------	----	---	--	---	-------------

<b>R M6020</b>	1D	Kit ricambio portagomma + dispositivo antirisucchio composto da: Ghiera bianca 1"1/4 Portagomma bianca 1"1/4 Dispositivo antirisucchio Tappo dispositivo antirisucchio Guarnizione piana 29,5x37,5		1	<b>5,34</b>
----------------	----	---	--	---	-------------

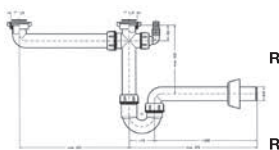

R Contattare il Customer Service per tempistiche sulla disponibilita



**Sifoni per lavelli**

**A "S" 2 bacinelle con attacco lavatrice e dispositivo antirisucchio**

- Polipropilene bianco
- Portata = 2800l/h

Codice	Classe	Descrizione	Scat.	Conf.	Euro pz.
<b>M144</b>	1D	1" 1/2 x 40	10	1	<b>23,52</b>

**Ricambi**

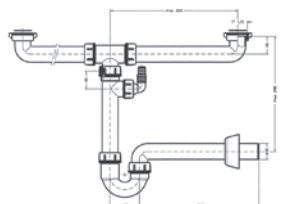

R <b>M6024</b>	1D	Rosone+ curva 90° Ø40		1	<b>6,87</b>
R <b>M6022</b>	1D	Kit ricambio composto da: No. 5 Ghiera bianca 1"1/2 No. 5 Guarnizione conica 1"1/2 No. 5 Anello premiguarnizione 1"1/2 No. 2 Guarnizione piana 1"1/2		1	<b>6,56</b>
R <b>M6020</b>	1D	Kit ricambio portagomma + dispositivo antirisucchio composto da: Ghiera bianca 1"1/4 Portagomma bianca 1"1/4 Dispositivo antirisucchio Tappo dispositivo antirisucchio Guarnizione piana 29,5x37,5		1	<b>5,34</b>

**Sifoni per lavelli Salvaspazio**



**"Ideal" 1 bacinella con attacco lavatrice e dispositivo antirisucchio**

- Polipropilene bianco
- Possibilità di tappare l'attacco lavatrice se non utilizzato
- Portata = 2800l/h

Codice	Classe	Descrizione	Scat.	Conf.	Euro pz.
<b>M151</b>	1D	1" 1/2 x 40	10	1	<b>25,31</b>

**Ricambi**

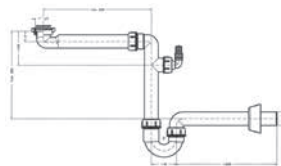

R <b>M6024</b>	1D	Rosone+ curva 90° Ø40		1	<b>6,87</b>
R <b>M6021</b>	1D	Kit di ricambio composto da: No. 3 Ghiera bianca 1"1/2 No. 3 Guarnizione conica 1"1/2 No. 3 Anello premiguarnizione 1"1/2 No. 2 Guarnizione piana 1"1/2		1	<b>5,65</b>
R <b>M6020</b>	1D	Kit ricambio portagomma + dispositivo antirisucchio composto da: Ghiera bianca 1"1/4 Portagomma bianca 1"1/4 Dispositivo antirisucchio Tappo dispositivo antirisucchio Guarnizione piana 29,5x37,5		1	<b>5,34</b>

R Contattare il Customer Service per tempistiche sulla disponibilità

**Sifoni per lavelli Salvaspazio**



**“Ideal” 2 bacinelle completo di attacco lavatrice e dispositivo antirisucchio**

- Polipropilene bianco
- Possibilità di tappare l'attacco lavatrice se non utilizzato
- Portata = 2800l/h

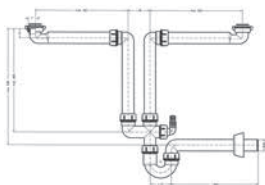

Codice	Classe	Descrizione	Scat.	Conf.	Euro pz.
<b>M155</b>	1D	1" 1/2 x 40	20	1	<b>38,02</b>

**Ricambi**

<b>R M6024</b>	1D	Rosone+ curva 90° Ø40		1	<b>6,87</b>
<b>R M6021</b>	1D	Kit di ricambio composto da: No. 3 Ghiera bianca 1"1/2 No. 3 Guarnizione conica 1"1/2 No. 3 Anello premiguarnizione 1"1/2 No. 2 Guarnizione piana 1"1/2		1	<b>5,65</b>
<b>R M6020</b>	1D	Kit ricambio portagomma + dispositivo antirisucchio composto da: Ghiera bianca 1"1/4 Portagomma bianca 1"1/4 Dispositivo antirisucchio Tappo dispositivo antirisucchio Guarnizione piana 29,5x37,5		1	<b>5,34</b>

**R** Contattare il Customer Service per tempistiche sulla disponibilita





**Pilette**

**1" 1/2 per sifone livello**

- Polipropilene bianco
- Portata = 3400 l/h

Codice	Classe	Descrizione	Scat.	Conf.	Euro pz.
<b>M162</b>	1D		20	1	<b>9,60</b>

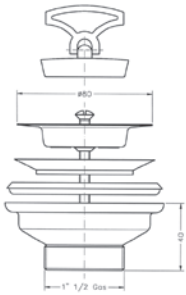

**1" 1/2 con troppo pieno per lavello inox completa di tappo**

- Polipropilene bianco
- Portata = 3400 l/h

Codice	Classe	Descrizione	Scat.	Conf.	Euro pz.
<b>M166</b>	1D		10	1	<b>22,21</b>

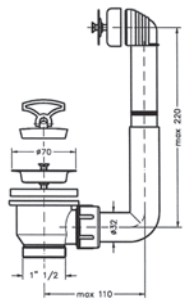



**Pilette**

1" 1/2 senza troppo pieno per lavello inox completa di tappo

- Polipropilene bianco
- Portata = 3400 l/h

Codice	Classe	Descrizione	Scat.	Conf.	Euro p.z.
<b>M167</b>	1D		20	1	<b>11,98</b>

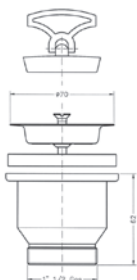

Per lavelli con foro 3" 1/2 senza troppo pieno con uscita da 1" 1/2

- Polipropilene bianco
- Portata = 3400 l/h

Codice	Classe	Descrizione	Scat.	Conf.	Euro p.z.
<b>M168</b>	1D		10	1	<b>46,48</b>

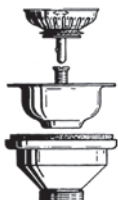

**Ricambi**

R <b>M1681</b>	1D	Tappo per piletta		10	<b>21,77</b>
----------------	----	-------------------	--	----	--------------



Per lavelli con foro 3" 1/2 e troppo pieno con uscita da 1" 1/2

- Polipropilene bianco
- Portata = 3400 l/h

Codice	Classe	Descrizione	Scat.	Conf.	Euro p.z.
<b>M169</b>	1D		10	1	<b>49,62</b>

**Ricambi**

R <b>M1681</b>	1D	Tappo per piletta		10	<b>21,77</b>
----------------	----	-------------------	--	----	--------------

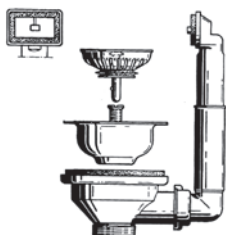

R Contattare il Customer Service per tempistiche sulla disponibilita



**Canotti**

1" 1/2 x 40 con attacco lavatrice completo di dispositivo antirisucchio  
 • Polipropilene bianco

Codice	Classe	Descrizione	Conf.	Euro pz.
<b>M163</b>	1D		5	<b>10,06</b>

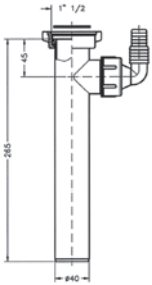

DN 40 x DN 40 con attacco lavatrice completo di dispositivo antirisucchio  
 • Polipropilene bianco

Codice	Classe	Descrizione	Conf.	Euro pz.
<b>M164</b>	1D		5	<b>10,23</b>

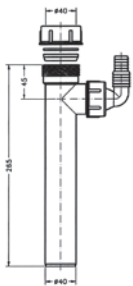



**Attacco doppio**

Per lavatrice e lavastoviglie completo di dispositivi antirisucchio

• Polipropilene bianco

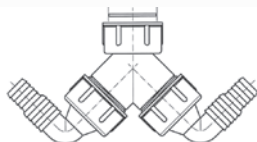

Codice	Classe	Descrizione	Conf.	Euro p.z.
<b>M165</b>	1D		5	<b>11,98</b>



**Curve d'allacciamento**

90°

• Polipropilene bianco



Codice	Classe	Descrizione	Conf.	Euro p.z.
<b>M171</b>	1D	DN 40 x 40 lunghezza 30 cm	10	<b>7,31</b>



45°

• Polipropilene bianco



Codice	Classe	Descrizione	Conf.	Euro p.z.
<b>M173</b>	1D	DN 40 x 40 lunghezza 30 cm	10	<b>11,83</b>



**Prolunga**

• Polipropilene bianco



Codice	Classe	Descrizione	Conf.	Euro p.z.
<b>M172</b>	1D	DN 40 x 40 lunghezza 30 cm	10	<b>8,14</b>

Riduzioni



**M678**



**M677**



**M628**



**M702**

Codice	Classe	DN	G	Conf.	Euro pz.
<b>M678</b>	1D	1" 1/4 M x 1" F		20	<b>2,27</b>
<b>M677</b>	1D	1" 1/2 M x 1" 1/4 F		20	<b>2,27</b>
<b>M628</b>	1D	1" 1/2 F x 1" 1/4 M		20	<b>2,47</b>
<b>M702</b>	1D	1" 1/4 F x 1" M		20	<b>2,57</b>

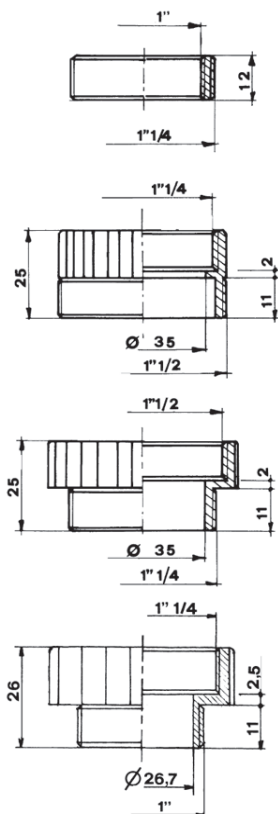



**Tubi estensibili**

	Codice	Classe	Descrizione	Conf.	Euro pz.
R	<b>M324</b>	1D	Ø 40/32 x 40/32 maschio/maschio	40	<b>3,15</b>
	<b>M400</b>	1D	Ø 40 maschio	40	<b>4,70</b>



**Tubi estensibili con ghiera cromata**

	Codice	Classe	Descrizione	Conf.	Euro pz.
	<b>M321</b>	1D	1" 1/4x32	40	<b>3,94</b>
	<b>M341</b>	1D	1" 1/4x32/40	40	<b>3,94</b>
	<b>M402</b>	1D	1"1/2x40	40	<b>3,94</b>
R	<b>M342</b>	1D	1"1/2x32/40	40	<b>3,94</b>



R Contattare il Customer Service per tempistiche sulla disponibilità

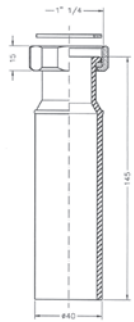

**Raccordo prolungato con dado in ottone**

Codice	Classe	DN	G	Conf.	Euro pz.
<b>M833</b>	1D	40	1" 1/4	20	<b>12,36</b>

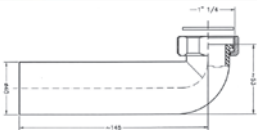

**Raccordo curvo con dado in ottone**

Codice	Classe	DN	G	Conf.	Euro pz.
<b>M850</b>	1D	40	1" 1/4	20	<b>11,94</b>
<b>M851</b>	1D	40	1" 1/2	20	<b>12,41</b>



**Raccordo - Passaggio al piombo DN 32**

• Ottone

Codice	Classe	Descrizione	Conf.	Euro pz.
<b>M681</b>	1D		20	<b>8,80</b>

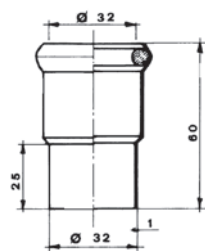

**Raccordo ridotto - passaggio al piombo DN 40 x 32**

• Ottone

Codice	Classe	Descrizione	Conf.	Euro pz.
<b>M694</b>	1D		20	<b>8,87</b>

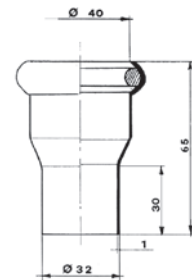

**Raccordo - passaggio al piombo DN 40**

• Ottone

Codice	Classe	Descrizione	Conf.	Euro pz.
<b>M635</b>	1D		20	<b>9,22</b>

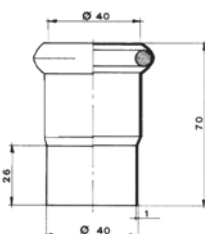



# M875

## Piletta Sifoide battente 50mm

### Dimensioni

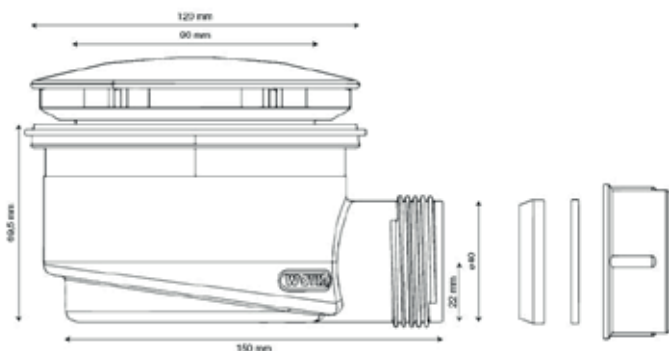

### Montaggio

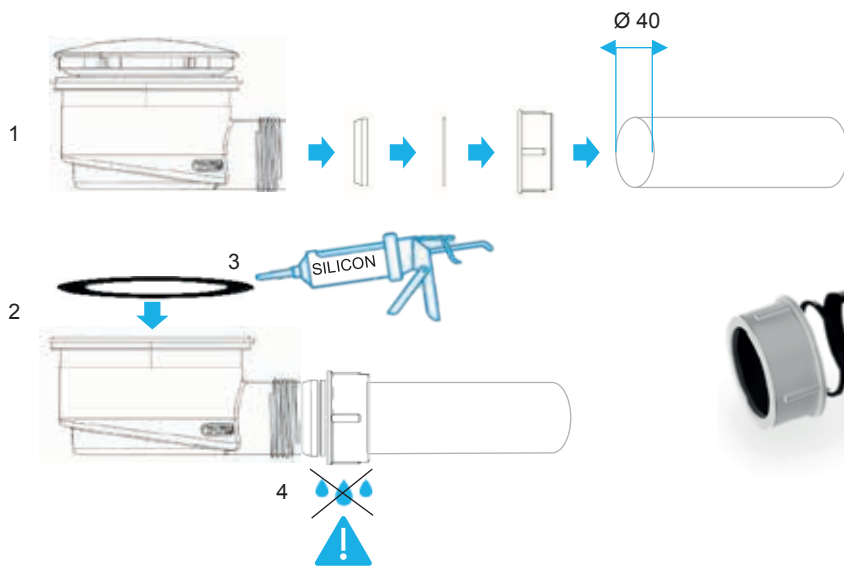

### Manutenzione



# M877

## Piletta Sifoide battente 30 mm

### Dimensioni

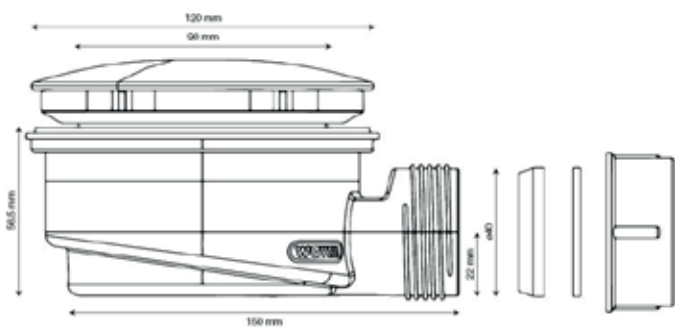

### Montaggio

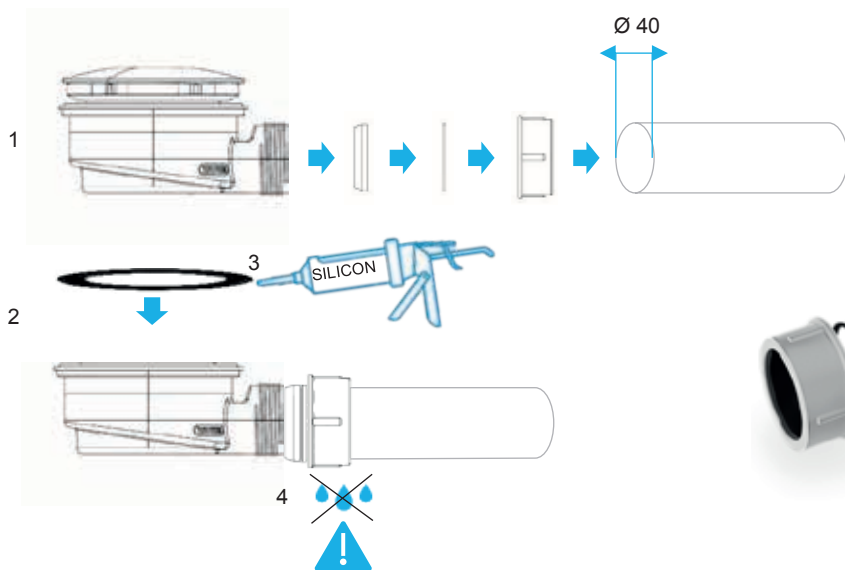

### Manutenzione



# M802

## Sifone per scarico vasca

### Installazione

#### A. Applicazione

Per vasca

#### B. Caratteristiche

Connessione tubazione scarico  $\varnothing 40/50$

Materiale: PEHD

#### C. Standard

EN274 (Trap)

#### D. Dati tecnici:

Portata: 2000 l/h

#### E. Informazioni Generali

Peso: 0.233 Kg

Quantità per scatola: 10 pezzi

Quantità per pallet: 480 pezzi

Fig.1

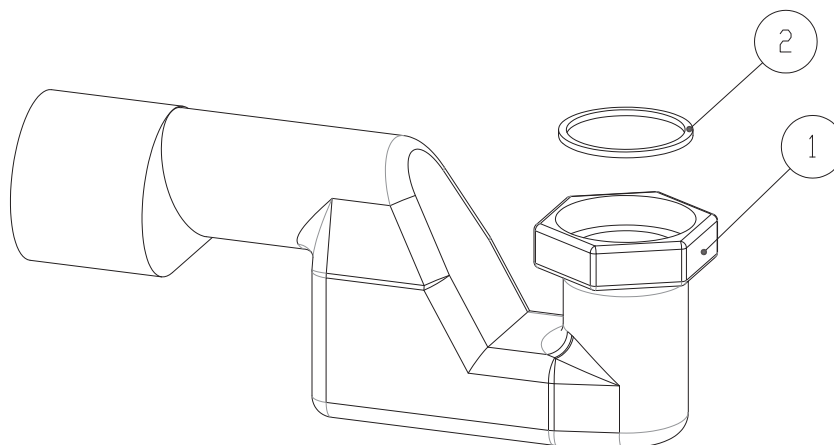
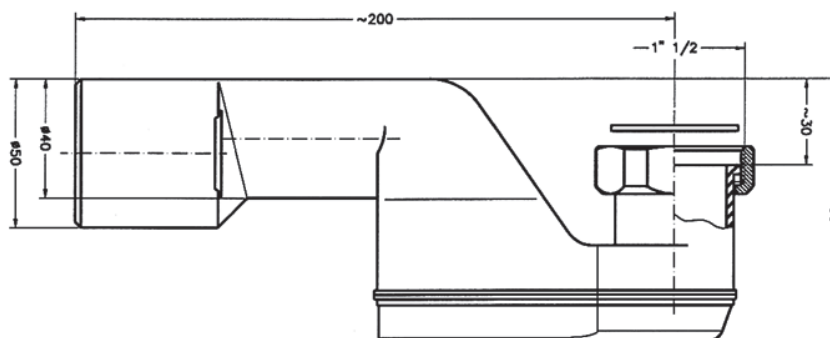

Fig.1

1. Corpo sifone vasca con dado in ottone da 1" 1/2
2. Guarnizione piana da 1" 1/2

Fig.2



# M852

## Sifone per scarico vasca

### Installazione

#### A. Applicazione

Per vasca

#### B. Caratteristiche

Connessione tubazione scarico Ø40/50

Materiale: PEHD

Rotazioni: orizzontale 280° - verticale 14°

Autopulente

#### C. Standard

EN274 (Trap)

#### D. Dati tecnici:

Portata: 2000 l/h

#### E. Informazioni Generali

Peso: 0.211 Kg

Quantità per scatola: 10 pezzi

Quantità per pallet: 640 pezzi

Fig.1

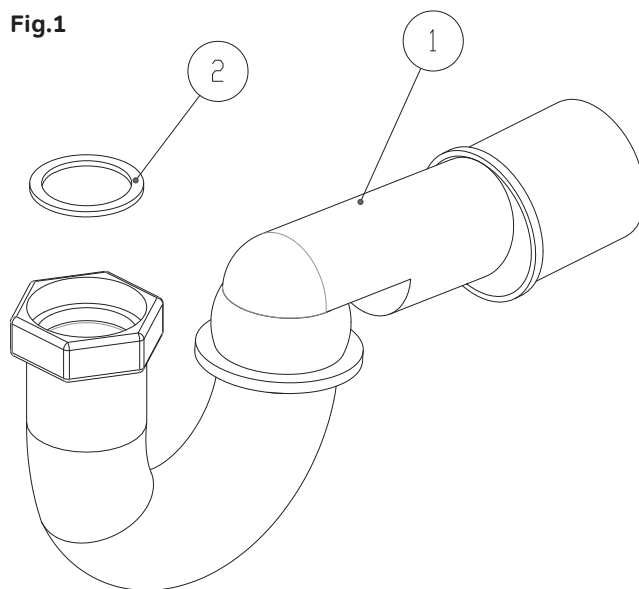

Fig.2

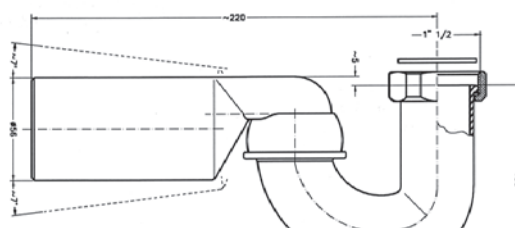
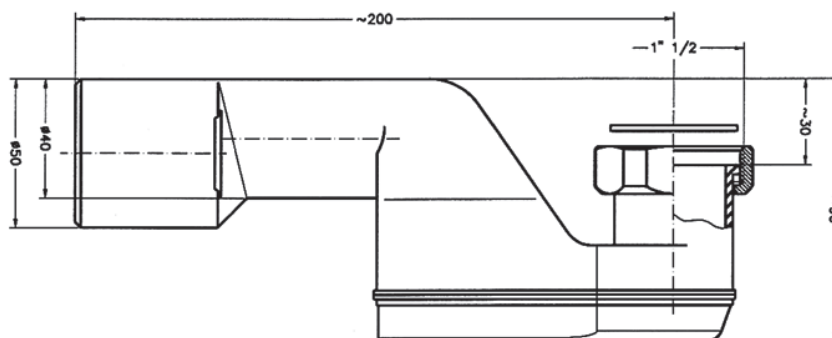

Fig.1

1. Tronchetto snodo Ø 40/50  
Tronchetto dado girevole da 1" 1/4  
con dado ottone da 1" 1/4
2. Guarnizione piana da 1" 1/4



# M853

## Sifone per scarico vasca

### Installazione

#### A. Applicazione

Per vasca

#### Caratteristiche

Connessione tubazione scarico Ø40/50

Materiale: PEHD

Rotazioni: orizzontale 280° - verticale 14°

Autopulente

#### B. Standard

EN274 (Trap)

#### C. Dati tecnici:

Portata: 2000 l/h

#### D. Informazioni Generali

Peso: 0.200 Kg

Quantità per scatola: 10 pezzi

Quantità per pallet: 640 pezzi

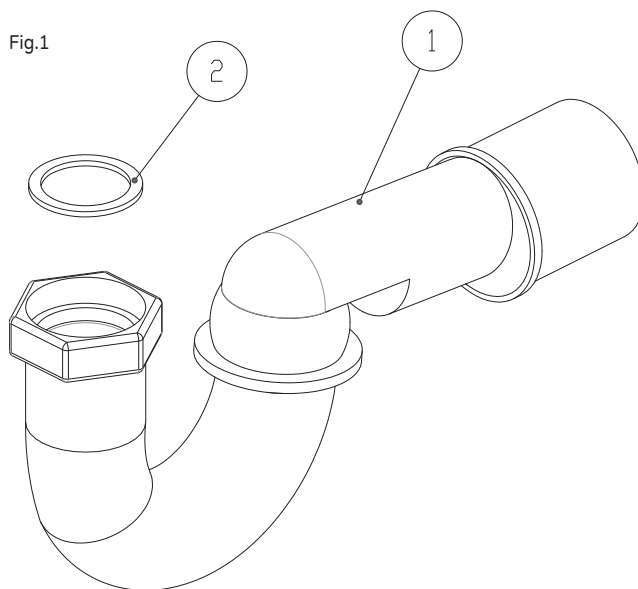

Fig.2

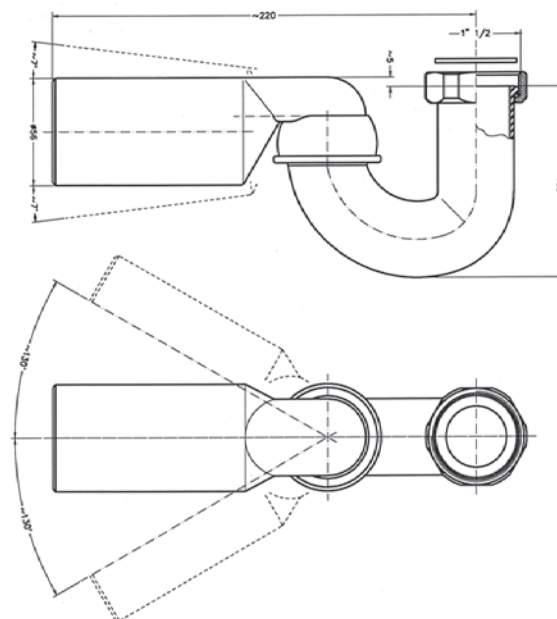

Fig.1

1. Tronchetto snodo Ø 40/50  
Curva a snodo a 180° con collare da 1" 1/2  
e dado ottone da 1" 1/2
2. Guarnizione piana da 1" 1/2

# M611

## Piletta a pavimento

### Installazione

#### A. Applicazione

Scarico a Pavimento

#### B. Caratteristiche

Dispositivo antirisucchio regolabile

Materiale: PEHD

#### C. Standard

EN 1253 (Waste floor gully with trap)

#### D. Informazioni Generali

Peso: 0.514 Kg

Quantità per scatola: 20 pezzi

Quantità per pallet: 160 pezzi

### Ricambi

**Codice catalogo M6111**

Griglia inox 100x100

**Codice catalogo M6110**

Filtro + Portafiltro 100x100

Fig.1

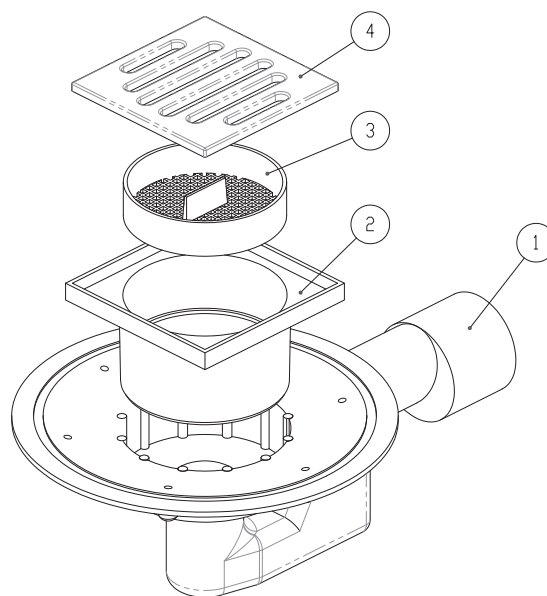

Fig.2

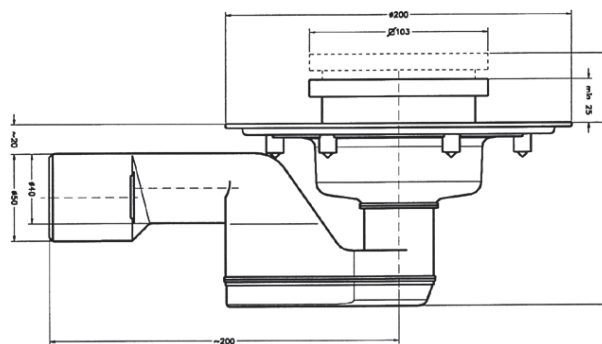

Fig.1

1. Corpo sifone vasca da 1" 1/2
2. Portafiltro 100x100
3. Filtro
4. Griglia 100x100

# M716/40

## Piletta a pavimento

### Installazione

#### A. Applicazione

Scarico a Pavimento

#### B. Caratteristiche

A snodo con uscita  $\varnothing$  40/50  
 Doppia guarnizione di tenuta  
 Materiale: PEHD  
 Autopulente

#### C. Standard

EN 1253 (Waste floor gully with trap)

#### D. Informazioni Generali

Peso: 0.480 Kg  
 Quantità per scatola: 20 pezzi  
 Quantità per pallet: 80 pezzi

#### E. Ricambi:

**Codice catalogo M6111**

Griglia inox 100x100

**Codice catalogo M6110**

Filtro + Portafiltro 100x100

Fig.1

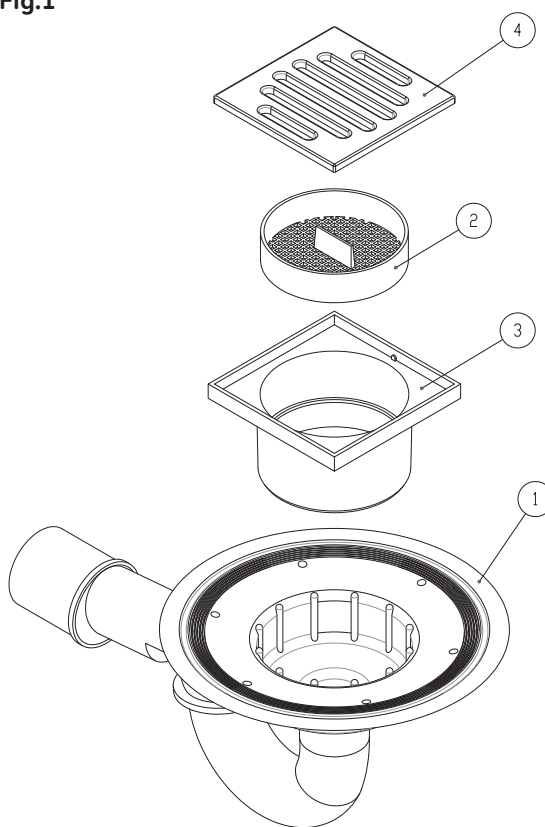
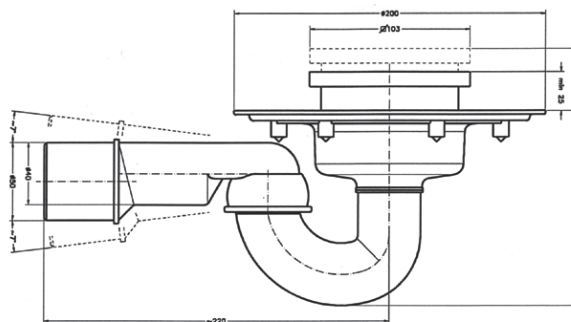

Fig.1

1. Tronchetto snodo  $\varnothing$  40/50 - Curva 180° a snodo con collare da 1" 1/2 - Flangia per minipiletta
2. Filtro
3. Portafiltro 100 x 100
4. Griglia 100 x 100



# M713

## Pozzetti a pavimento

### Installazione

#### A. Applicazione

Scarico a Pavimento

#### B. Caratteristiche

Materiale: PEHD

Regolabile

#### C. Standard

EN 1253 (Waste floor gully with trap)

#### D. Informazioni Generali

Peso: 0.593 Kg

Quantità per scatola: 1 pezzi

Quantità per pallet: 80 pezzi

#### E. Ricambi:

**Codice catalogo M6111**

Griglia inox 100x100

**Codice catalogo M6110**

Filtro + Portafiltro 100x100

Fig.1

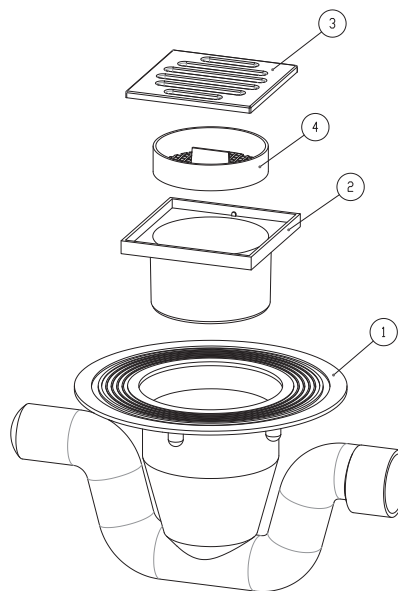

Fig.2

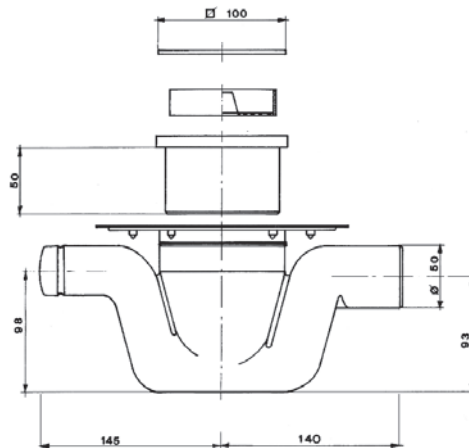

Fig.1

1. Doppio tronchetto snodo Ø 50  
Flangia per maxipiletta
2. Portafiltro 100 x 100
3. Griglia 100 x 100
4. Filtro



# M614

## Pozzetti a pavimento

### Installazione

#### A. Applicazione

Scarico a Pavimento

#### B. Caratteristiche

3 ingressi DN 40 1 uscita DN 50 - Ingressi da forare

Materiale: Polipropilene grigio

Valvola antiritorno regolabile H 53 mm

Guarnizioni a labbro inserite

#### C. Standard

EN 1253 (Floor trap)

#### D. Dati Tecnici

Portata: 2880 l/h

#### E. Informazioni Generali

Peso: 0,708Kg

Quantità per scatola: 1 pezzi

Quantità per pallet: 80 pezzi

Fig.1

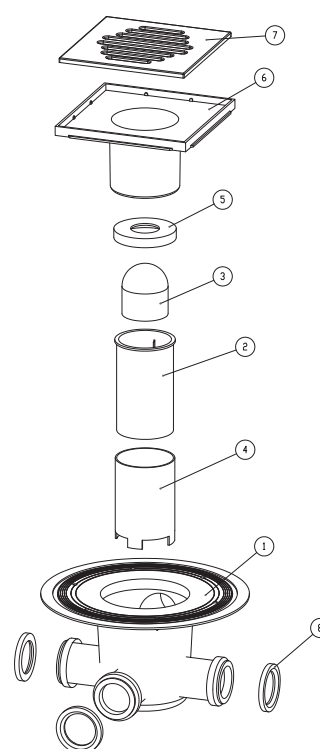

Fig.2

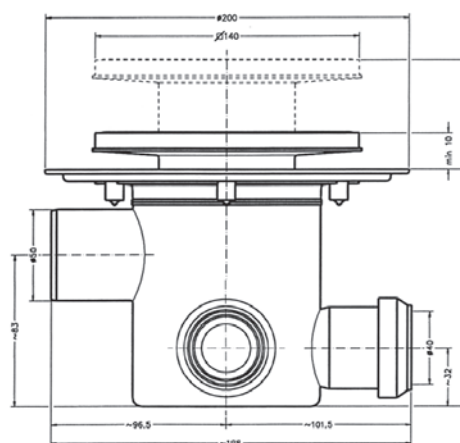

Fig.1

1. Pozzetto basso a pavimento a 4 vie con flangia
2. Pescante a cannocchiale
3. Valvola
4. Prolunga
5. Guarnizione aperta
6. Portagriglia 140 x 140
7. Griglia inox 140 x 140
8. Guarnizione a labbro DN40

# M618

## Pozzetti a pavimento

### Installazione

#### A. Applicazione

Scarico a Pavimento

#### B. Caratteristiche

3 ingressi DN 40 1 uscita DN 50 - Ingressi da forare

Materiale: PEHD

#### C. Standard

EN 1253 (Floor Trap)

#### D. Dati Tecnici

Portata: 2880 l/h

#### E. Informazioni Generali

Peso: 0.307 Kg

Quantità per scatola: 5 pezzi

Quantità per pallet: 160 pezzi

Fig.1

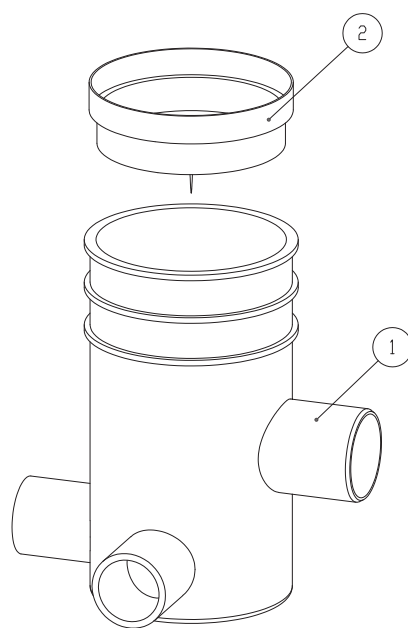

Fig.2

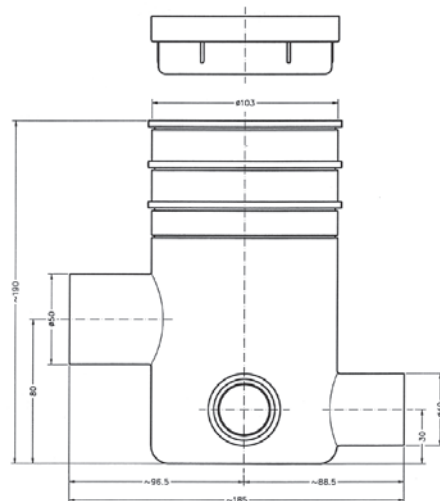

Fig.1

1. Pozzetto medio a pavimento a 4 vie
2. Tappo di protezione

# M643

## Pozzetti a pavimento

### Installazione

#### A. Applicazione

Scarico a Pavimento

#### B. Caratteristiche

3 ingressi DN 40 1 uscita DN 50 - Ingressi da forare

Materiale: Polipropilene grigio

Guarnizioni a labbro inserite

#### C. Standard

EN 1253 (Floor trap)

#### D. Dati Tecnici

Portata: 2880 l/h

#### E. Informazioni Generali

Peso: 0.357 Kg

Quantità per scatola: 20 pezzi

Quantità per pallet: 120 pezzi

Fig.1

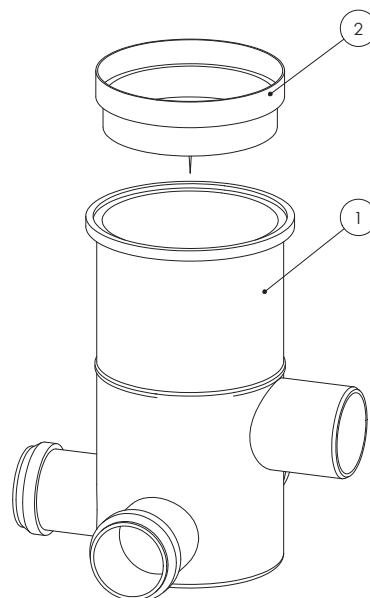
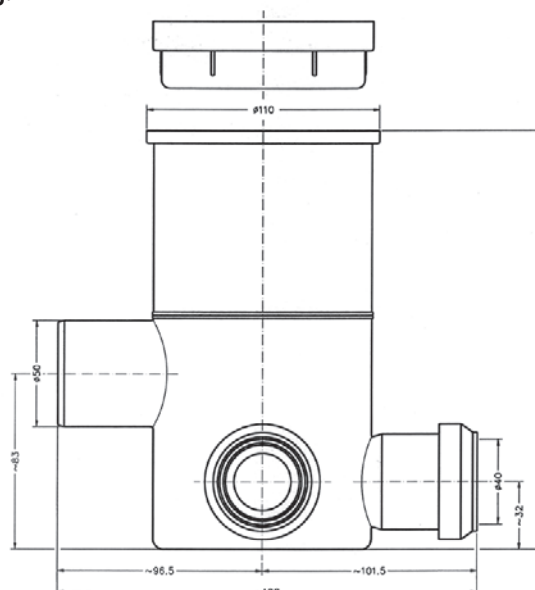

Fig.1

1. Pozzetto basso a pavimento a 4 vie prolunga pozzetto – guarnizione a labbro
2. Tappo di protezione

Fig.2



# M682

## Pozzetti a pavimento

### Installazione

#### A. Applicazione

Scarico a Pavimento

#### B. Caratteristiche

3 ingressi DN 40 1 uscita DN 40 - Ingressi da forare

Materiale: Polipropilene grigio

Guarnizioni inserite

#### C. Standard

EN 1253 (Floor trap)

#### D. Dati Tecnici

Portata: 2880 l/h

#### E. Informazioni Generali

Peso: 0.274 Kg

Quantità per scatola: 20 pezzi

Quantità per pallet: 120 pezzi

Fig.1

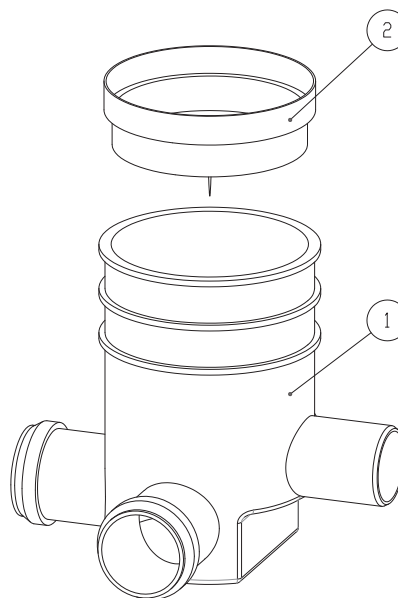

Fig.2

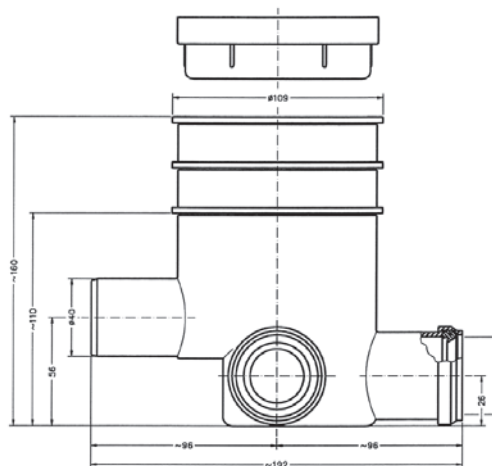

Fig.1

1. Pozzetto a pavimento universale a 4 vie
2. Tappo di protezione

# M699

## Pozzetti a pavimento

### Installazione

#### A. Applicazione

Scarico a Pavimento

#### B. Caratteristiche

3 ingressi DN 40 1 uscita DN 50 - Ingressi da forare

Materiale: Polipropilene grigio

Guarnizioni inserite

#### C. Standard

EN 1253 (Floor trap)

#### D. Dati Tecnici

Portata: 2880 l/h

#### E. Informazioni Generali

Peso: 0.286 Kg

Quantità per scatola: 20 pezzi

Quantità per pallet: 120 pezzi

Fig.1

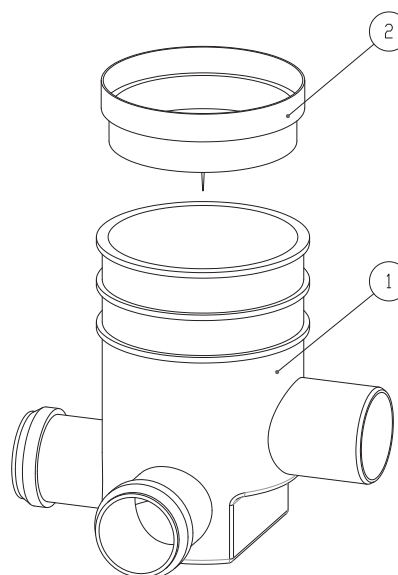

Fig.2

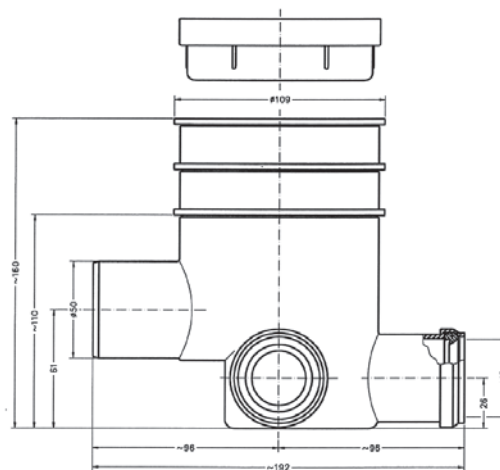

Fig.1

1. Pozzetto universale a pavimento a 4 vie guarnizione a labbro
2. Tappo di protezione

# M114

## Sifone per lavabo a "S" da 1"1/4 x 40

### Installazione

#### A. Applicazione

Per lavabo, bidet

#### B. Caratteristiche

Connessione tubazione scarico Ø40

Materiale: Polipropilene bianco

#### C. Standard

EN 274 (Trap)

#### D. Dati Tecnici:

Portata: 2000 l/h

#### E. Informazioni Generali

Peso: 0.304 Kg

Quantità per scatola: 50 pz.

Quantità per pallet: 200 pz.

#### F. Ricambi

##### Codice catalogo M6024

Rosone + Curva 90° Ø 40

##### Codice catalogo M6009

(Kit ricambio)

N° 2 pz. Ghiera bianca 1" 1/2

N° 2 pz. Guarnizione conica 1" 1/2

N° 2 pezzi anello premiguarnizione 1" 1/2

N° 1 pezzo Guarnizione piana 1" 1/4

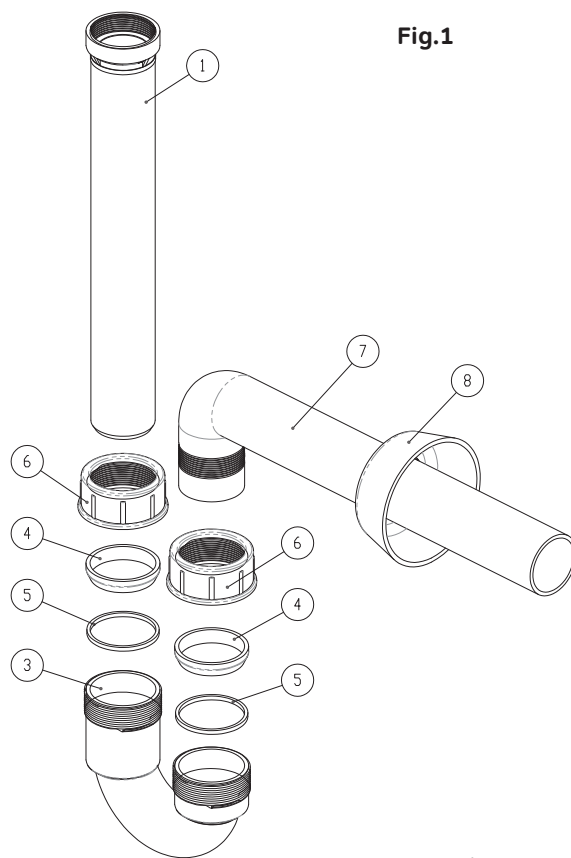
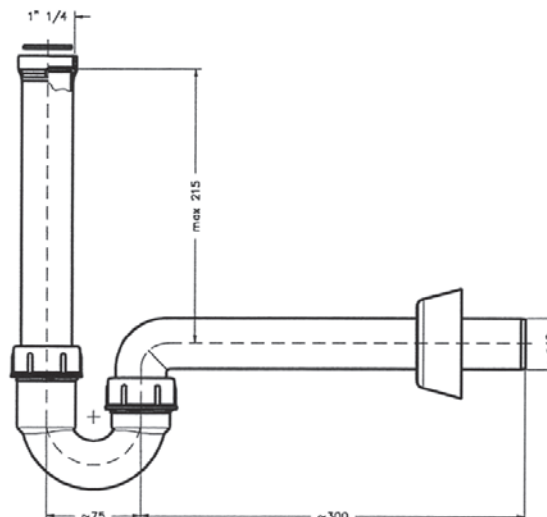

Fig.1

Fig.2

Fig.1

1. Tronchetto Ø 40 con filetto da 1" 1/4
2. Curva a 180° Ø 40 per lavelli
3. Guarnizione conica da 1" 1/2
4. Anello premi guarnizione
5. Ghiera da 1" 1/2
6. Curva a 90° Ø 40 L = 300 mm
7. Rosone DN 40 x 85



# M115

## Sifone per bidet a "S" da 1"1/4 x 40

### Installazione

#### A. Applicazione

Per bidet

#### B. Caratteristiche

Connessione tubazione scarico Ø40  
Materiale: Polipropilene bianco

#### C. Standard

EN 274 (Trap)

#### D. Dati Tecnici:

Portata: 2000 l/h

#### E. Informazioni Generali

Peso: 0.234 Kg  
Quantità per scatola: 20 pz.  
Quantità per pallet: 240 pz.

#### F. Ricambi

##### Codice catalogo M6016

Rosone + Curva 45° sifone bidet

##### Codice catalogo M6015

##### (Kit ricambio)

- N° 2 pz. Ghiera bianca 1" 1/4
- N° 2 pz. Guarnizione conica 1" 1/4
- N° 2 pezzi anello premiguarnizione 1" 1/4
- N° 1 pezzo Guarnizione piana 1" 1/4
- N° 1 pezzo Ghiera bianca fil. Gas 1" 1/4

Fig.1

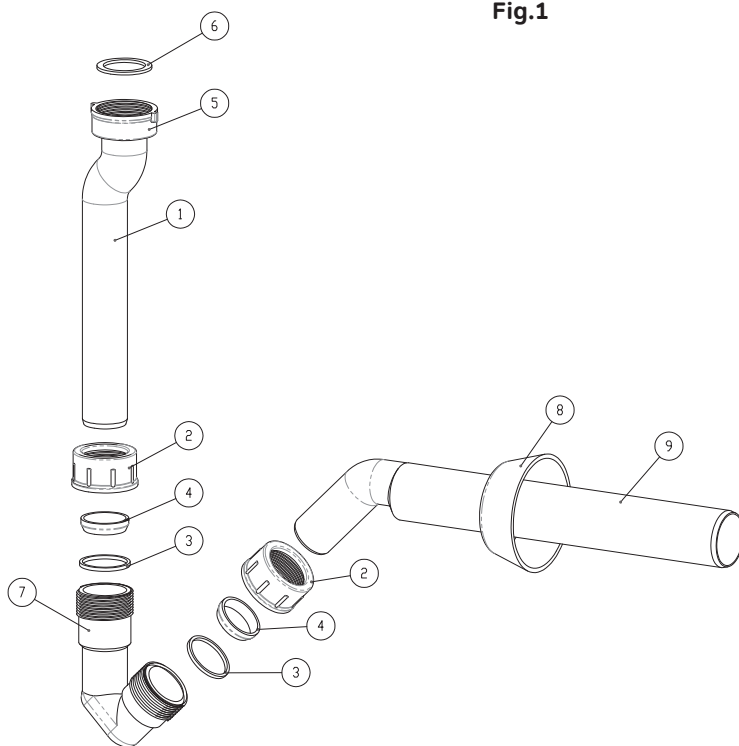

Fig.2

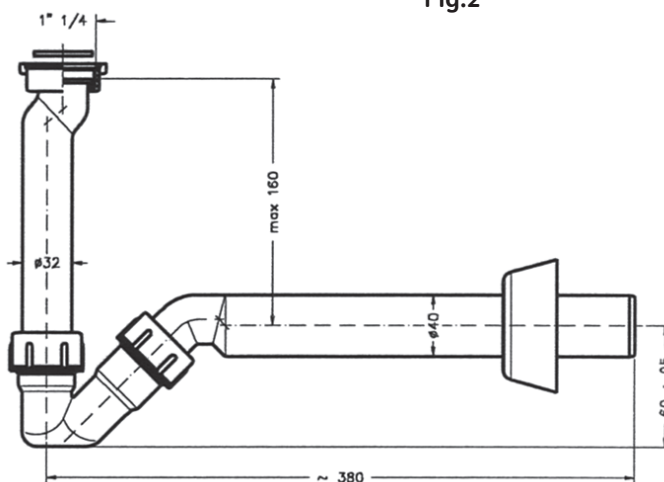

Fig.1

1. Tronchetto disassato Ø 32
2. Ghiera da 1" 1/4 gas
3. Anello premiguarnizione da 1" 1/4
4. Guarnizione conica da 1" 1/4
5. Ghiera da 1" 1/4
6. Guarnizione piana da 1" 1/4
7. Curva a 135° Ø 32 x 1" 1/4
8. Rosone DN 40 x 85
9. Curva a 45° Ø 40 / 32

# M125

## Sifone per lavello a "S" 1 bacinella da 1"1/2 x 40

### Installazione

#### A. Applicazione

Per lavello

#### B. Caratteristiche

Connessione tubazione scarico Ø40

Materiale: Polipropilene bianco

#### C. Standard

EN 274 (Trap)

#### D. Dati Tecnici:

Portata: 2800 l/h

#### E. Informazioni Generali

Peso: 0.305 Kg

Quantità per scatola: 10 pz.

Quantità per pallet: 160 pz.

#### F. Ricambi

##### Codice catalogo M1251

Ghiera filetto gas 1" 1/2

##### Codice catalogo M6024

Rosone + Curva 90° Ø40

##### Codice catalogo M6019

##### (Kit ricambio)

N° 2 pz. Ghiera bianca 1"

N° 2 pz. Guarnizione conica 1" 1/2

N° 2 pezzi anello premiguarnizione 1" 1/2

N° 1 pezzo Guarnizione piana 1" 1/2

N° 1 pezzo Ghiera bianca fil. Gas 1" 1/2

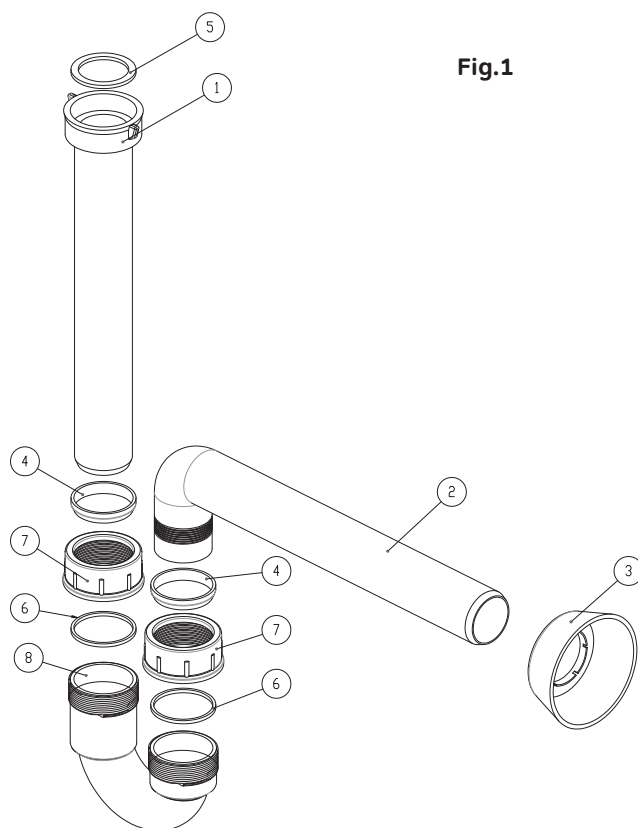

Fig.1

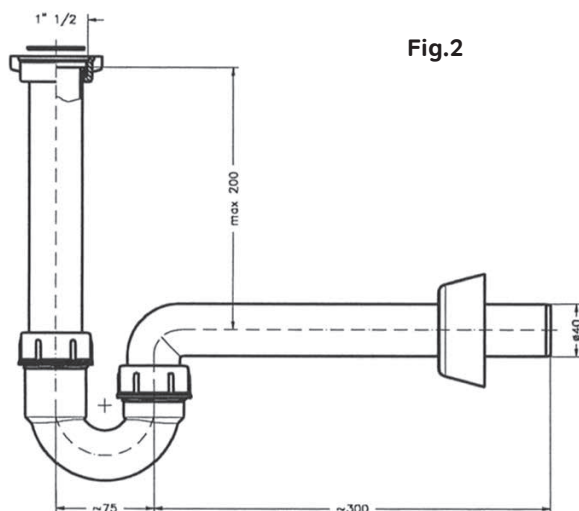

Fig.2

Fig.1

1. Tronchetto Ø 40 con cartella da 1" 1/2 e Ghiera da 1" 1/2 Gas
2. Curva a 90° Ø 40 L = 300 mm
3. Rosone DN 40 x 85
4. Guarnizione conica da 1" 1/2
5. Guarnizione piana da 1" 1/2
6. Anello premi guarnizione
7. Ghiera da 1" 1/2
8. Curva a 180° Ø 40 per lavelli



# M126

## Sifone per lavello a "S" 1 bacinella con attacco lavatrice e dispositivo antirisucchio

### Installazione

#### A. Applicazione

Per lavello

#### B. Caratteristiche

Connessione tubazione scarico Ø40  
Materiale: Polipropilene bianco

#### C. Standard

EN 274 (Trap)

#### D. Dati Tecnici:

Portata: 2800 l/h

#### E. Informazioni Generali

Peso: 0.350 Kg  
Quantità per scatola: 20 pz.  
Quantità per pallet: 240 pz.

#### F. Ricambi

##### Codice catalogo M6024

Rosone + Curva 90° Ø40

##### Codice catalogo M6019

##### (Kit ricambio)

N° 2 pezzi Ghiera bianca 1" 1/2

N° 2 pezzi Guarnizione conica 1" 1/2

N° 2 pezzi Anello premiguarnizione 1" 1/2

N° 1 pezzo Guarnizione piana 1" 1/2

##### Codice catalogo M6020 (Kit ricambio portagomma + dispositivo antirisucchio)

Ghiera bianca 1" 1/4

Portagomma bianca 1" 1/4

Dispositivo antirisucchio

Tappo dispositivo antirisucchio

Guarnizione piana 29.5 x 37.5

#### Fig.1

1. Ghiera da 1" 1/2 gas
2. Curva a 90° Ø 40 L = 300 mm
3. Rosone DN 40 x 85
4. Guarnizione conica da 1" 1/2
5. Guarnizione piana da 1" 1/2
6. Guarnizione piana Ø 29,5 x Ø 37,5
7. Ghiera da 1" 1/4
8. Anello premiguarnizione
9. Ghiera da 1" 1/2
10. Curva a 180° Ø 40 per lavelli
11. Dispositivo antirisucchio
12. Portagomma da 1" 1/4

Fig.1

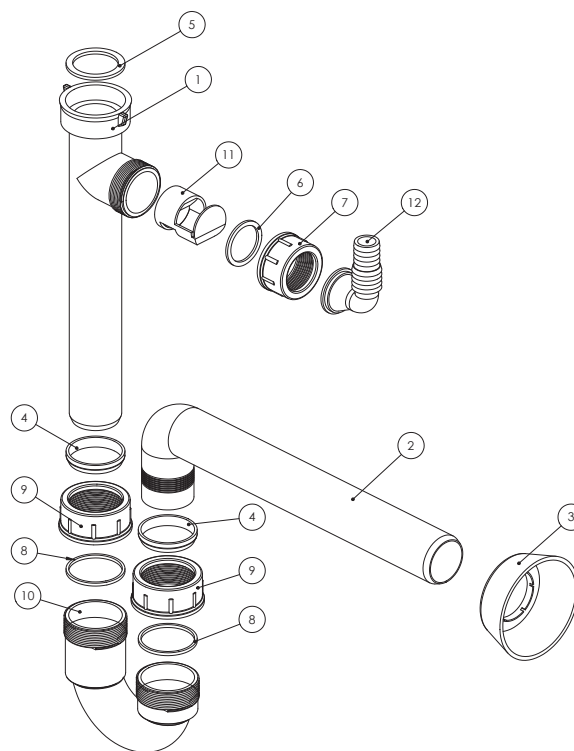
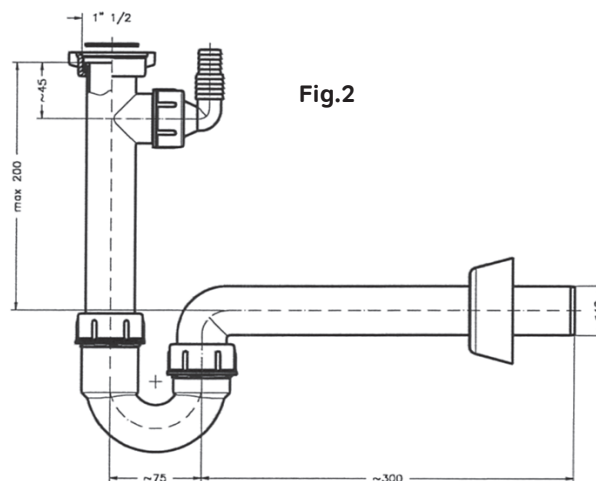

Fig.2



# M136

## Sifone per lavello a "S" 2 bacinelle con attacco lavatrice e dispositivo antirisucchio

### Installazione

#### A. Applicazione

Per lavello

#### B. Caratteristiche

Connessione tubazione scarico  $\varnothing 40$

Materiale: Polipropilene bianco

#### C. Standard

EN 274 (Trap)

#### D. Dati Tecnici:

Portata: 2800 l/h

#### E. Informazioni Generali

Peso: 0.477 Kg

Quantità per scatola: 20 pz.

Quantità per pallet: 160 pz.

#### F. Ricambi

##### Codice catalogo M6024

Rosone + Curva 90°  $\varnothing 40$

##### Codice catalogo M6021

(Kit ricambio)

N° 3 pezzi Ghiera bianca 1" 1/2

N° 3 pezzi Guarnizione conica 1" 1/2

N° 3 pezzi Anello premiguarnizione 1" 1/2

N° 2 pezzi Guarnizione piana 1" 1/2

##### Codice catalogo M6020

(Kit ricambio portagomma + dispositivo antirisucchio)

Ghiera bianca 1" 1/4

Portagomma bianca 1" 1/4

Dispositivo antirisucchio

Tappo dispositivo antirisucchio

Guarnizione piana 29.5 x 37.5

Fig.1

1. Tronc.  $\varnothing 40$  con adattatore da 1" 1/4 - 1" 1/2
2. Curva a 90°  $\varnothing 40$  con cartella
3. Curva a 90°  $\varnothing 40$  L = 300 mm
4. Rosone DN 40 x 85
5. Guarnizione conica da 1" 1/2
6. Guarnizione piana da 1" 1/2
7. Guarnizione piana  $\varnothing 29,5 \times \varnothing 37,5$
8. Anello premi guarnizione
9. Ghiera da 1" 1/4
10. Ghiera da 1" 1/2
11. Curva a 180°  $\varnothing 40$  per lavelli
12. Dispositivo antirisucchio
13. Portagomma da 1" 1/4

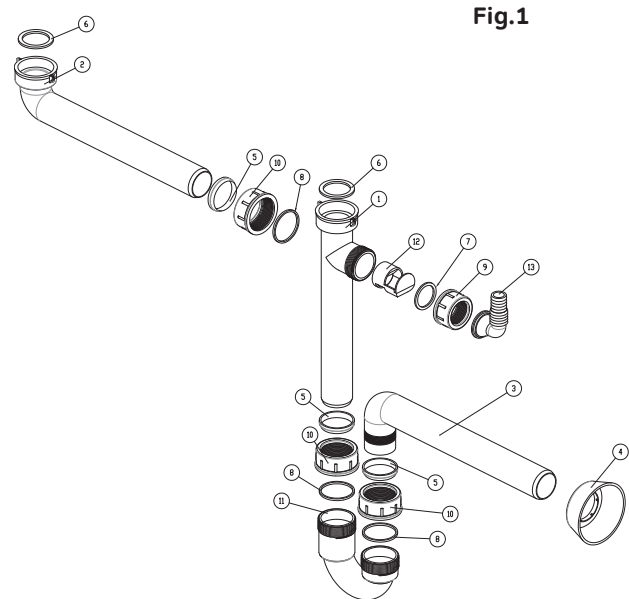

Fig.1

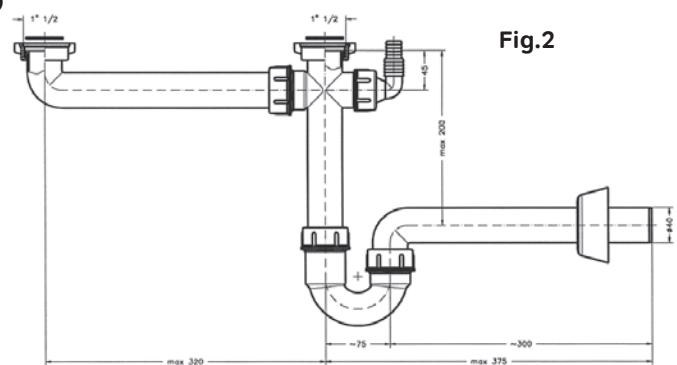

Fig.2

# M144

## Sifone per lavello a "S" 2 bacinelle con attacco lavatrice e dispositivo antirisucchio

### Installazione

#### A. Applicazione

Per lavello

#### B. Caratteristiche

Connessione tubazione scarico Ø40  
Materiale: Polipropilene bianco

#### C. Standard

EN 274 (Trap)

#### D. Dati Tecnici:

Portata: 2800 l/h

#### E. Informazioni Generali

Peso: 0.598 Kg  
Quantità per scatola: 10 pz.  
Quantità per pallet: 80 pz.

#### F. Ricambi

##### Codice catalogo M6024

Rosone + Curva 90° Ø40

##### Codice catalogo M6022 (Kit ricambio)

N° 5 pezzi Ghiera bianca 1" 1/2  
N° 5 pezzi Guarnizione conica 1" 1/2  
N° 5 pezzi Anello premiguarnizione 1" 1/2  
N° 2 pezzo Guarnizione piana 1" 1/2

##### Codice catalogo M6020

##### (Kit ricambio portagomma + dispositivo antirisucchio)

Ghiera bianca 1" 1/4  
Portagomma bianca 1" 1/4  
Dispositivo antirisucchio  
Tappo dispositivo antirisucchio  
Guarnizione piana 29.5 x 37.5

#### Fig.1

1. Tronchetto filettato Ø 40 x 1" 1/2 ed attacco lavatrice
2. Dispositivo antirisucchio
3. Guarnizione piana Ø 29,5 x Ø 37,5
4. Portagomma da 1" 1/4
5. Ghiera da 1" 1/4
6. Curva a 180° Ø 40 per lavelli
7. Guarnizione conica da 1" 1/2
8. Anello premi guarnizione
9. Ghiera da 1" 1/2
10. Curva a 90° Ø 40 L = 300 mm
11. Rosone DN 40 x 85
12. "T" Ø 40 CON 2 FILETTI DA 1" 1/2
13. Ghiera da 1" 1/2 Gas

Fig.1

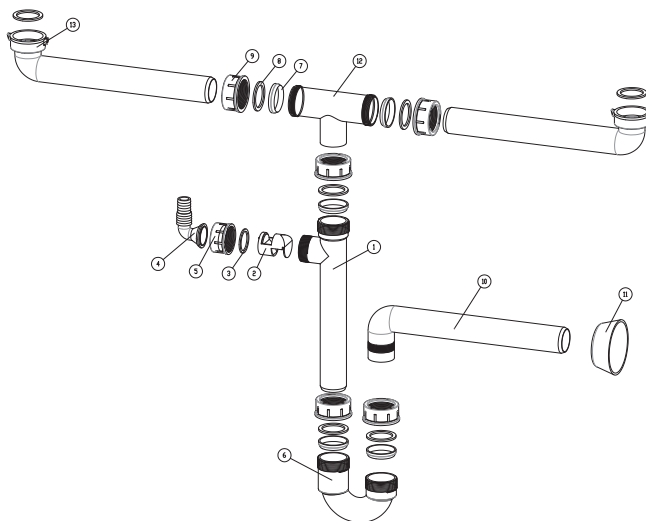
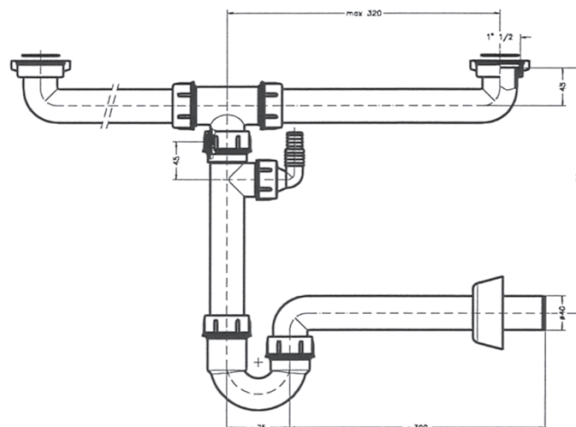

Fig.2



# M151

## Sifone per lavello a 1 bacinella con attacco lavatrice e dispositivo antirisucchio

### Installazione

#### A. Applicazione

Per lavello

#### B. Caratteristiche

Connessione tubazione scarico Ø40

Materiale: Polipropilene bianco

#### C. Standard

EN 274 (Trap)

#### D. Dati Tecnici:

Portata: 2800 l/h

#### E. Informazioni Generali

Peso: 0.565 Kg

Quantità per scatola: 10 pz.

Quantità per pallet: 160 pz.

#### F. Ricambi

##### Codice catalogo M6024

Rosone + Curva 90° Ø40

##### Codice catalogo M6021 (Kit ricambio)

N° 3 pezzi Ghiera bianca 1" 1/2

N° 3 pezzi Guarnizione conica 1" 1/2

N° 3 pezzi Anello premiguarnizione 1" 1/2

N° 2 pezzo Guarnizione piana 1" 1/2

##### Codice catalogo M6020

##### (Kit ricambio portagomma + dispositivo antirisucchio)

Ghiera bianca 1" 1/4

Portagomma bianca 1" 1/4

Dispositivo antirisucchio

Tappo dispositivo antirisucchio

Guarnizione piana 29.5 x 37.5

Fig.1

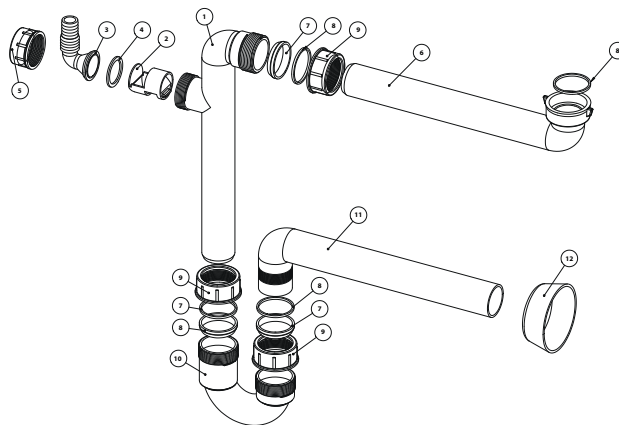
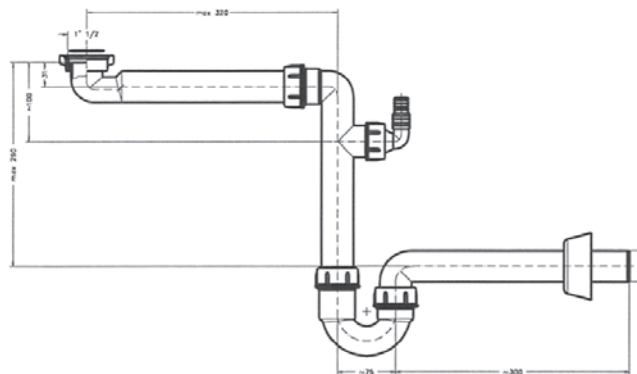

Fig.2



#### Fig.1

1. Curva filettata a 90° Ø 40 x 1" 1/2 ed attacco da 1" 1/4
2. Dispositivo antirisucchio
3. Portagomma da 1" 1/4
4. Guarnizione piana Ø 29,5 x Ø 37,5
5. Ghiera da 1" 1/4
6. Curva ribassata a 90° Ø 40 con cartella
7. Guarnizione conica da 1" 1/2
8. Anello premi guarnizione
9. Ghiera da 1" 1/2
10. Curva a 180° Ø 40 per lavelli
11. Curva a 90° Ø 40 L = 300 mm
12. Rosone DN 40 x 85

# M155

## Sifone per lavello a 2 bacinelle con attacco lavatrice e dispositivo antirisucchio

### Installazione

#### A. Applicazione

Per lavello

#### B. Caratteristiche

Connessione tubazione scarico  $\varnothing 40$   
Materiale: Polipropilene bianco

#### C. Standard

EN 274 (Trap)

#### D. Dati Tecnici:

Portata: 2800 l/h

#### E. Informazioni Generali

Peso: 0.565 Kg

Quantità per scatola: 10 pz.

Quantità per pallet: 160 pz.

#### F. Ricambi

##### Codice catalogo M6024

Rosone + Curva 90°  $\varnothing 40$

##### Codice catalogo M6021 (Kit ricambio)

N° 3 pezzi Ghiera bianca 1" 1/2

N° 3 pezzi Guarnizione conica 1" 1/2

N° 3 pezzi Anello premiguarnizione 1" 1/2

N° 2 pezzo Guarnizione piana 1" 1/2

##### Codice catalogo M6020

##### (Kit ricambio portagomma + dispositivo antirisucchio)

Ghiera bianca 1" 1/4

Portagomma bianca 1" 1/4

Dispositivo antirisucchio

Tappo dispositivo antirisucchio

Guarnizione piana 29.5 x 37.5

#### Fig.1

1. Raccordo a 2 vie  $\varnothing 40 \times 1" 1/2$  + filetto da 1" 1/4
2. Curva a 180°  $\varnothing 40$  per lavelli
3. Guarnizione conica da 1" 1/2
4. Anello premi guarnizione
5. Ghiera da 1" 1/2
6. Curva a 90°  $\varnothing 40$  L = 300 mm
7. Rosone DN 40 x 85
8. Dispositivo antirisucchio
9. Portagomma da 1" 1/4
10. Guarnizione piana  $\varnothing 29,5 \times \varnothing 37,5$
11. Ghiera da 1" 1/4
12. Curva filettata a 90°  $\varnothing 40 \times 1" 1/2$

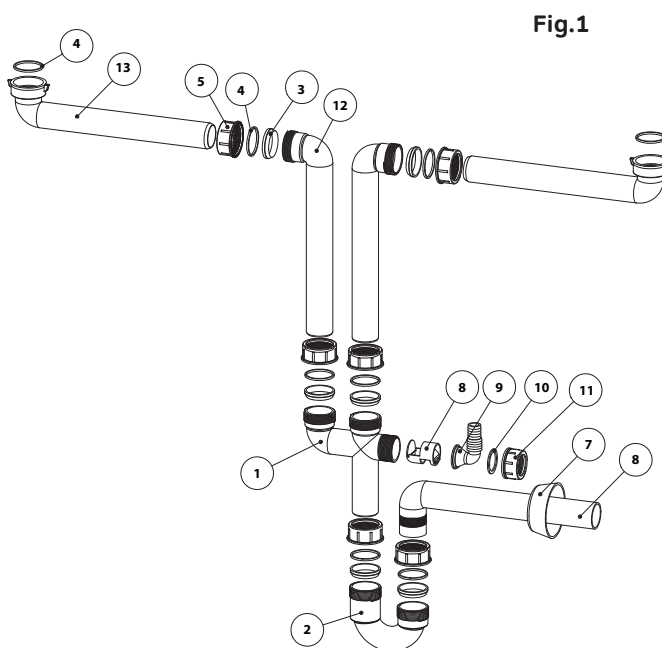
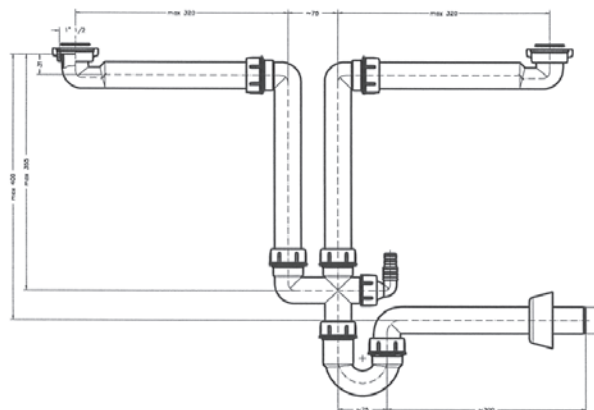

Fig.1

Fig.2



# M162

## Piletta per lavello da 1"1/2

### Installazione

#### A. Applicazione

Per lavello

#### B. Caratteristiche

Connessione tubazione scarico 1" 1/2 Gas

Materiale: Polipropilene bianco

#### C. Standard

EN 274 (Waste outle)

#### D. Dati Tecnici:

Portata: 3400 l/h

#### E. Informazioni Generali

Peso: 0.128 Kg

Quantità per scatola: 20 pezzi

Quantità per pallet: 640 pezzi

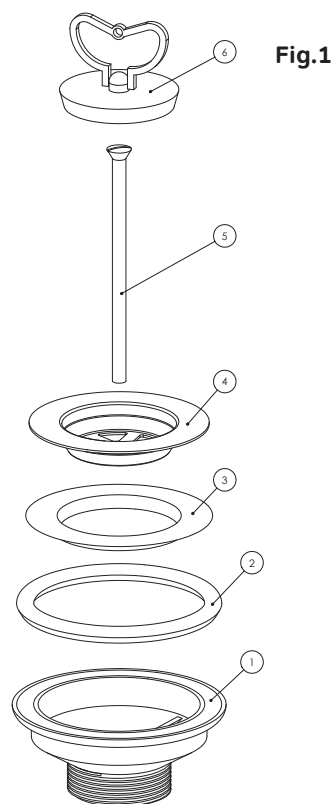

Fig.1

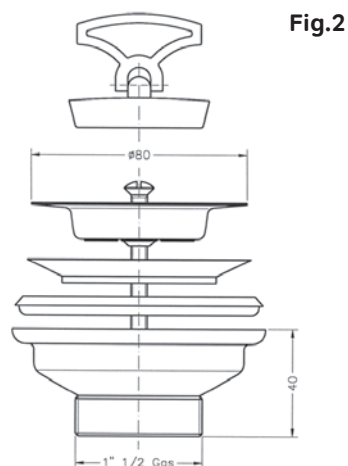

Fig.2

#### Fig.1

1. Portapiletta da 1" 1/2 con dado zigrinato DM11
2. Guarnizione nera per piletta DN 80
3. Guarnizione bianca per piletta DN 80
4. Piletta DN 80
5. Vite nichelata M 6 x 100
6. Tappo DN 52 per piletta

# M166

## Piletta per lavello da 1"1/2 con troppo pieno

### Installazione

#### A. Applicazione

Per lavello

#### B. Caratteristiche

Materiale: Polipropilene bianco

#### C. Standard

EN 274 (Waste outlet)

#### D. Dati Tecnici:

Portata: 3400 l/h

#### E. Informazioni Generali

Peso: 0.208 Kg

Quantità per scatola: 10 pezzi

Quantità per pallet: 320 pezzi

Fig.1

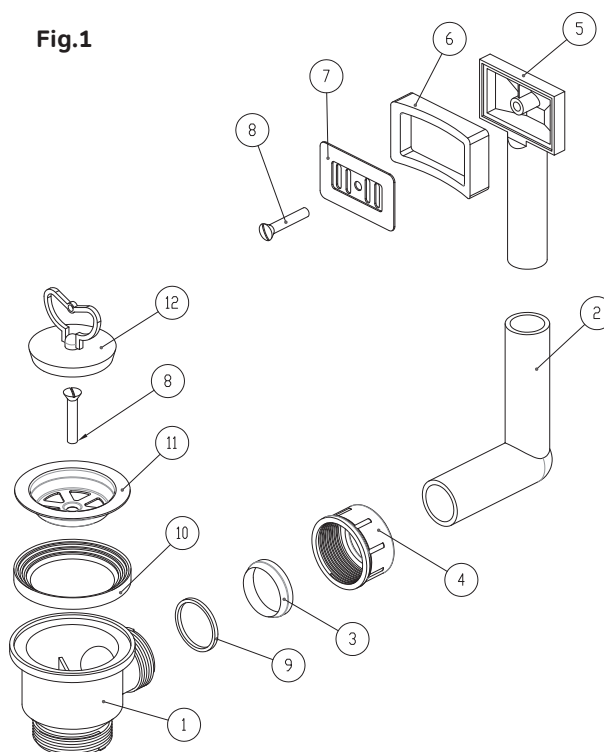
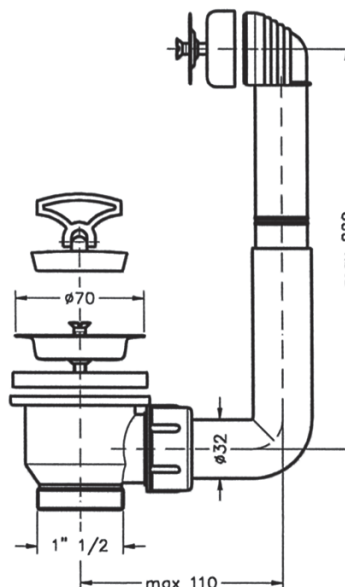

Fig.1

1. Piletta con troppo pieno
2. Gomito per piletta con troppo pieno
3. Guarnizione conica da 1" 1/4
4. Ghiera da 1" 1/4
5. Tronchetto per piletta con troppo pieno
6. Inserto per piletta con troppo pieno
7. Griglia per troppo pieno
8. Vite nichelata M 6 x 30
9. Anello premiguarnizione da 1" 1/4
10. Guarnizione bianca DN 70
11. Piletta DN 70
12. Tappo DN 52 per piletta



# M167

## Piletta per lavello da 1"1/2 senza troppo pieno completa di tappo

### Installazione

#### A. Applicazione

Per lavello

#### B. Caratteristiche

Materiale: Polipropilene bianco

#### C. Standard

EN 274 (Waste outlet)

#### D. Dati Tecnici:

Portata: 3400 l/h

#### E. Informazioni Generali

Peso: 0.098 Kg

Quantità per scatola: 20 pezzi

Quantità per pallet: 640 pezzi

Fig.1

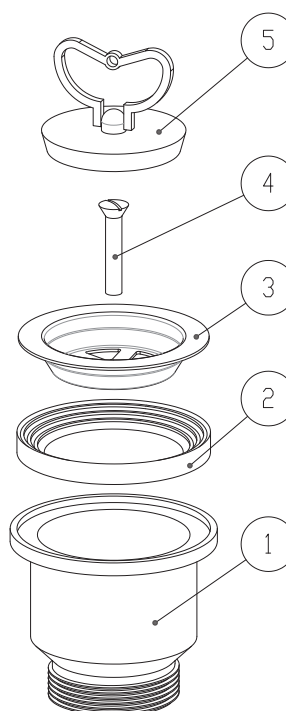

Fig.2

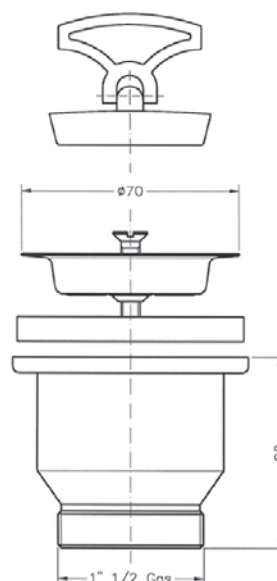

Fig.1

1. Piletta senza troppo pieno
2. Guarnizione bianca DN 70
3. Piletta DN 70
4. Vite nichelata M 6 x 35
5. Tappo DN 52 per piletta



# M168

## Piletta per lavello con foro 3" 1/2 senza troppo pieno con uscita da 1" 1/2

### Installazione

#### A. Applicazione

Per lavello

#### B. Caratteristiche

Materiale: Polipropilene bianco

#### C. Standard

EN 274 (Waste outlet)

#### D. Dati Tecnici:

Portata: 3400 l/h

#### E. Informazioni Generali

Peso: 0.253 Kg

Quantità per scatola: 10 pezzi

Quantità per pallet: 640 pezzi

Fig.1

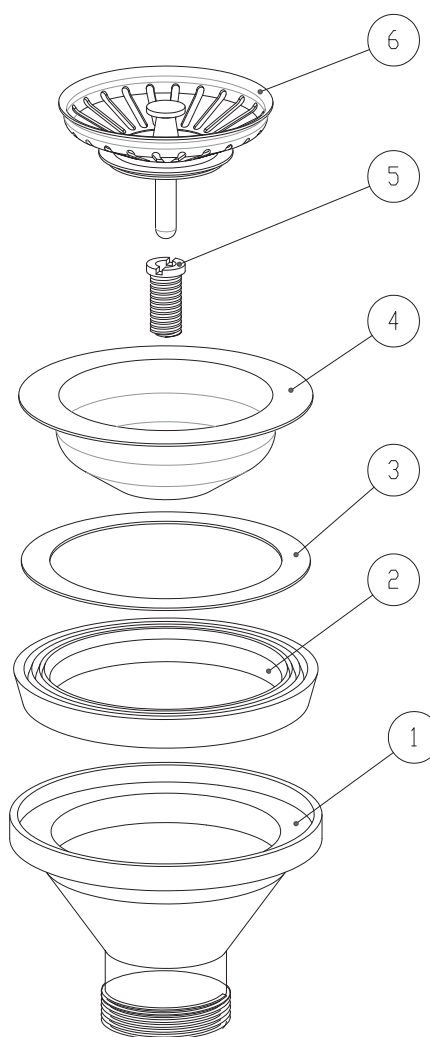

Fig.1

1. Piletta senza troppo pieno
2. Guarnizione bianca DN 70
3. Anello premi guarnizione
4. Piletta DN 70
5. Vite nichelata M 6 x 35
6. Tappo DN 52 per piletta

# M169

## Piletta per lavello con foro da 3" 1/2 e troppo pieno con uscita da 1" 1/2

### Installazione

#### A. Applicazione

Per lavello

#### B. Caratteristiche

Materiale: Polipropilene bianco

#### C. Standard

EN 274 (Waste outlet)

#### D. Dati Tecnici:

Portata: 3400 l/h

#### E. Informazioni Generali

Peso: 0.332 Kg

Quantità per scatola: 10 pezzi

Quantità per pallet: 480 pezzi

Fig.1

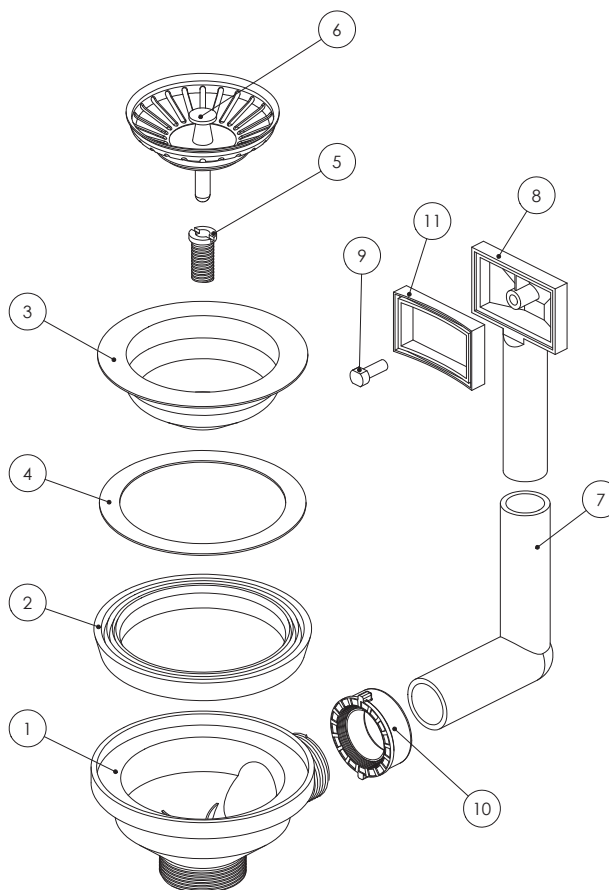

Fig.1

1. Piletta con troppo pieno
2. Guarnizione bianca DN 70
3. Porta piletta
4. Anello premi guarnizione
5. Vite nichelata M 6 x 30
6. Piletta DN 70
7. Gomito per piletta con troppo pieno
8. Tronchetto per piletta con troppo pieno
9. Vite nichelata M 6 x 30
10. Ghiera da 1" 1/2
11. Inserto per piletta con troppo pieno

# M623

## Sifone lavatrice

### Installazione

#### A. Applicazione

Per lavatrice

#### B. Caratteristiche

Materiale: PEHD

Ispezione da 1"

#### C. Standard

EN 274 (Trap)

#### D. Dati Tecnici

Portata: 700 l/h

#### E. Informazioni Generali

Peso: 0.320 Kg

Quantità per scatola: 5 pezzi

Quantità per pallet: 240 pezzi

### Ricambi

**Codice catalogo M6234**

Piastra inox 110x160

**Codice M6005 (Kit ricambio)**

Rosone cromato 1"

Portagomma cromato 1"

Ghiera cromata 1"

O-ring

**Codice M6025**

Tappo filettato 1" + guarnizione piana 1"

Fig.1

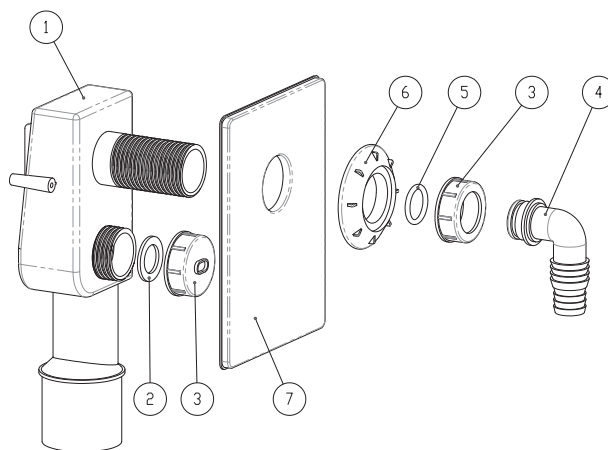

Fig.2

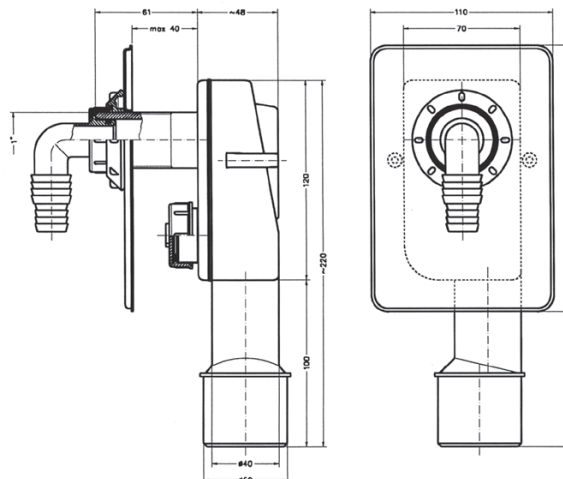

Fig.1

1. Corpo sifone lavatrice
2. Guarnizione piana da 1"
3. Tappo filettato da 1"
4. Portagomma cromato
5. O-ring
6. Rosone cromato da 1"
7. Piastra 110x160

# M715

## Sifone lavatrice

### Installazione

#### A. Applicazione

Per lavatrice

#### B. Caratteristiche

Materiale: Poliolefina bianca

#### C. Standard

EN 274 (Trap)

#### D. Dati Tecnici

Portata: 700 l/h

#### E. Informazioni Generali

Peso: 0.292 Kg

Quantità per scatola: 20 pezzi

Quantità per pallet: 240 pezzi

#### F. Ricambi:

##### Codice catalogo M6004 (Kit ricambio)

Rosone bianco 1" 1/4

Portagomma bianco 1" 1/4

Ghiera bianca 1" 1/4

O-ring

Fig.1

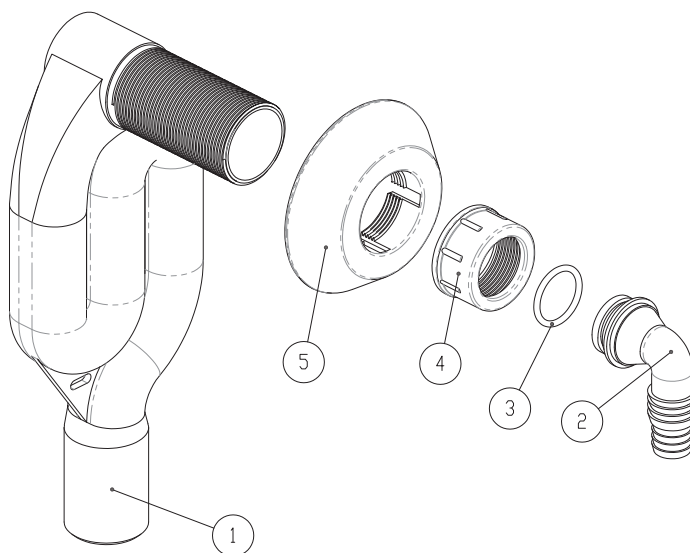

Fig.1

1. Corpo sifone lavatrice
2. Portagomma bianco 1" 1/4
3. O-ring
4. Ghiera bianca 1" 1/4
5. Rosone bianco 1" 1/4

# M723

## Sifone lavatrice

### Installazione

#### A. Applicazione

Per lavatrice

#### B. Caratteristiche

Materiale: PEHD

Ispezione da 1"

#### C. Standard

EN274 (Trap)

#### D. Dati tecnici:

Portata: 700 l/h

#### E. Informazioni Generali

Peso: 0.320 Kg

Quantità per scatola: 5 pezzi

Quantità per pallet: 240 pezzi

#### F. Ricambi:

##### Codice catalogo M6006 (Kit ricambio)

Piastra bianca ABS

Rosone bianco 1"

Ghiera bianca 1"

Portagomma bianco 1"

O-ring

##### Codice M6025

Tappo filettato 1" + guarnizione piana 1"

Fig.1

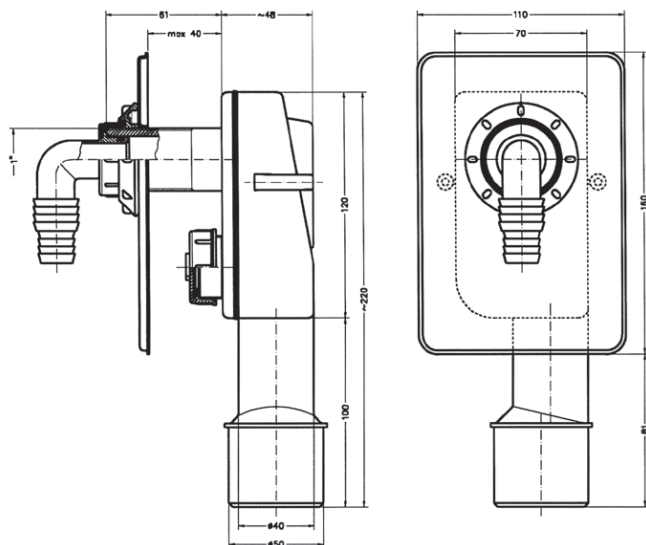
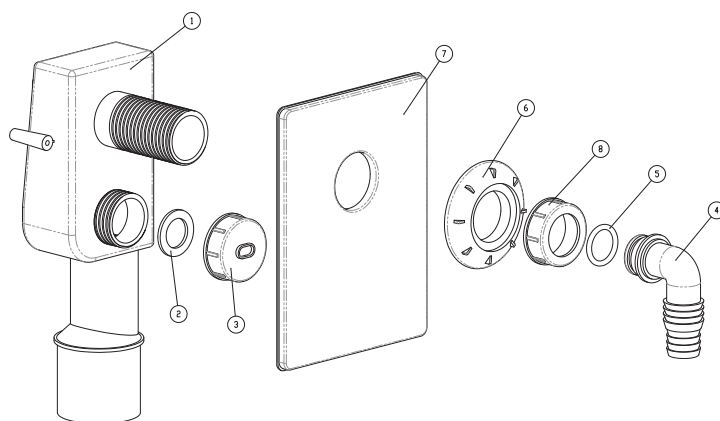

Fig.1

1. Corpo sifone lavatrice
2. Guarnizione piana da 1"
3. Tappo filettato da 1"
4. Portagomma
5. O-ring
6. Rosone da 1"
7. Piastra 110x160

## Sifone a membrana HEPvO®

Il sifone di scarico HEPvO®, è un prodotto che rivoluziona il modo di concepire gli scarichi delle acque bianche sia nelle costruzioni civili che nelle applicazioni particolari. La sua particolare conformazione non pone vincoli di spazio permettendo l'installazione su qualunque apparecchio (lavabo, bidet, vasca, orinatoio) ed in qualunque inclinazione, può essere infatti posizionato orizzontalmente, verticalmente o in obliquo. Internamente, il sifone è dotato di una valvola

autosigillante costituita da una membrana che si chiude al di sotto dell'utenza, dopo il passaggio dell'acqua. In questo modo il sifone impedisce il ritorno nell'ambiente di odori sgradevoli, mantiene costante l'equilibrio delle pressioni negli scarichi (specie in presenza di pressioni negative), è esente dalla proliferazione di funghi, batteri, evita il ristagno di materia solida in decomposizione, funziona in assenza di acqua.



Il sifone HEPvO® è quindi consigliato in tutti quei casi limite, dove un sifone normale può incontrare dei seri problemi: presenza di pressioni negative, autosifonaggio, sifonaggio indotto, compressione, evaporazione, effetto del vento, presenza di schiuma, quantità improvvisa d'acqua, azione capillare, perdite, movimento (installazione su treni, camper, imbarcazioni), problemi di spazio. A tale riguardo il

sifone HEPvO®, installato in senso verticale, risulta la soluzione ottimale per i lavandini dove i piedistalli a colonna sono molto stretti (vedi figura 1). Altra soluzione ottimale per i lavelli da cucina (vedi figura 2). HEPvO® può essere installato orizzontalmente utilizzando l'adattatore 90° (vedi figure 3 e 4). Se installato orizzontalmente raccomandiamo una pendenza di almeno 1%.

### IMPORTANTE:

**al fine di rimuovere sostanza protettiva si raccomanda di lavare con un getto d'acqua prima dell'installazione l'interno della membrana**

Fig. 1

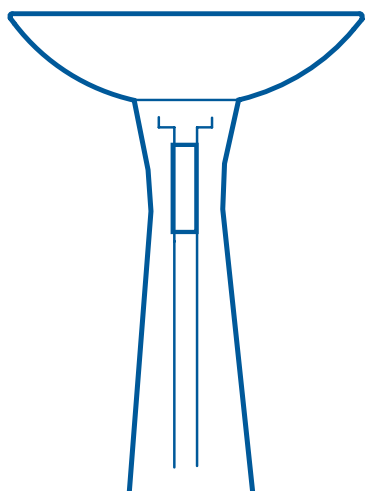
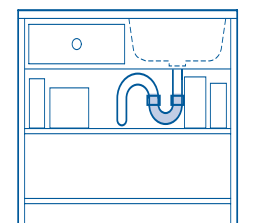
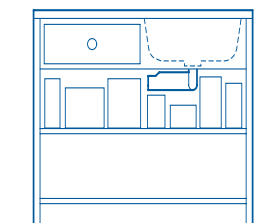

Fig. 2



Lavello con sifone



Lavello con sifone HEPvO® installato orizzontalmente

In caso di applicazione come sifone per scarico condensa raccomandiamo di prevedere nell'installazione un salto di quota di almeno 20 cm tra l'apparecchio e il sifone, tale da garantire la corretta apertura della membrana

Fig. 3

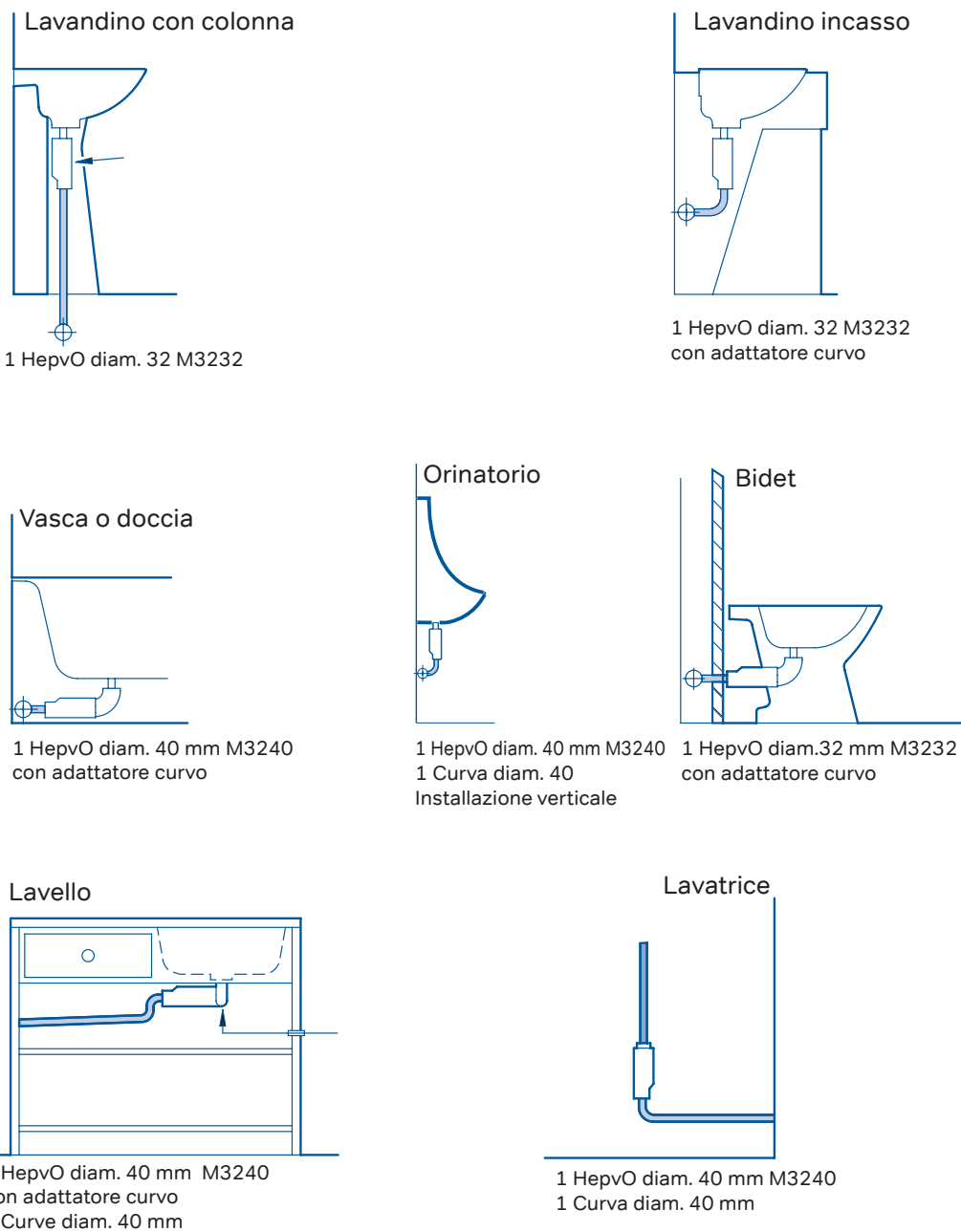
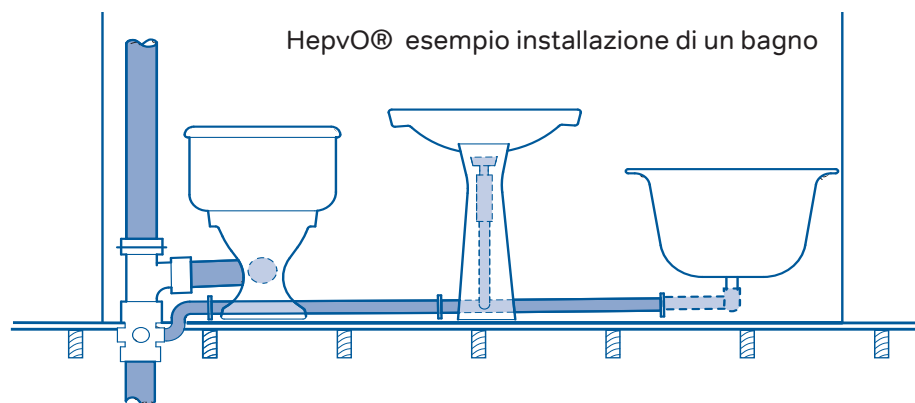
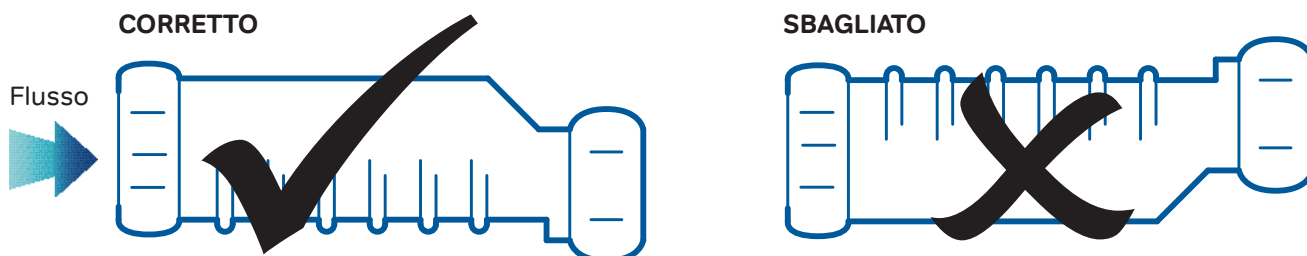

Fig. 4



### Installazione sifone HEPvO®

Corretto posizionamento di HepvO® quando l'installazione avviene in senso orizzontale



Se installato orizzontalmente le costole devono essere posizionate verso il basso per assicurare la corretta operatività.

Il sifone HepvO® e gli adattatori sono disponibili nelle dimensioni 32mm e 40mm. Nelle applicazioni orizzontali il sifone HepvO® deve essere installato con l'adattatore curvo 87,5°.

Tutti le figure disponibili HepvO® sono prodotte in polipropilene bianco. Di seguito tabella dimensioni HepvO®:

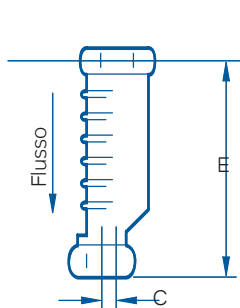

a) Installazione in senso verticale collegare direttamente all'utenza.

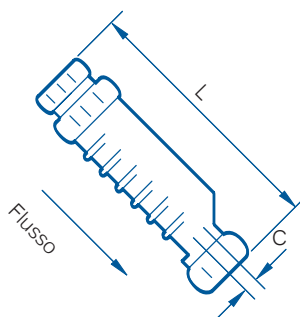

b) Installato ad un tubo con qualsiasi inclinazione per il collegamento utilizzare l'adattatore diritto (disponibile separatamente)

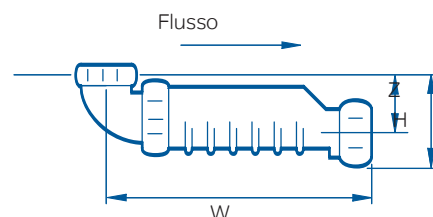

c) Installazione in senso orizzontale collegamento all'utenza tramite adattatore curvo (disponibile separatamente)

Diametro	C	E	L	W	Z	H
32mm	8	171	208	211	40	70
40mm	5	171	208	213	40	73



Codice	Classe	Descrizione	Conf.	Euro pz.
M3232	1D	Kit sifone scarico Ø 32 + adattatori diritto e curvo	1	53,43
M3240	1D	Kit sifone scarico Ø 40 + adattatori diritto e curvo	1	58,13



Ricambi cassetta esterna ÈLITE

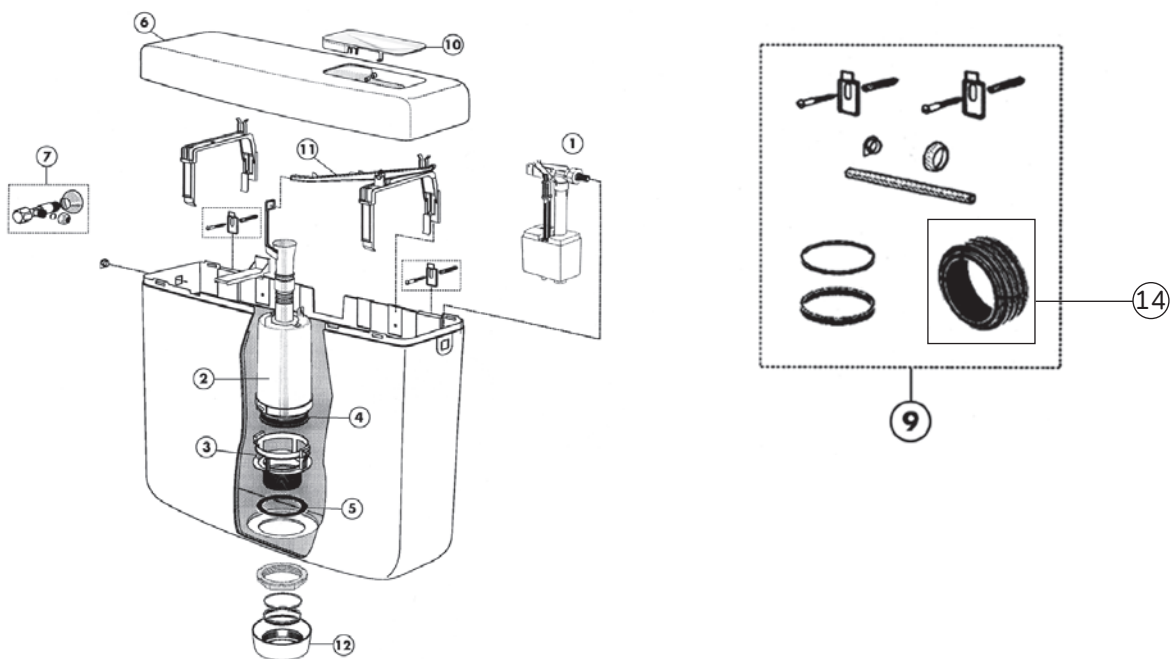

Codice	Numero	Classe	Descrizione	Euro p.z.
<b>312064</b>	1	I3	Rubinetto a galleggiante universale	<b>119,65</b>
<b>R 312062</b>	2	I3	Valvola di scarico	<b>45,46</b>
<b>R 312068</b>	3	I3	Sede di fondo per valvola scarico	<b>25,56</b>
<b>312072</b>	4	I3	Guarnizione di fondo per valvola scarico	<b>12,95</b>
<b>R 312066</b>	7	I3	Rubinetto di arresto 1/2" a squadra	<b>21,85</b>
<b>R 312088</b>	9	I3	Set di fissaggio + guarnizioni	<b>14,50</b>
<b>R 312084</b>	11	I3	Leva per valvola di scarico	<b>8,22</b>
<b>R 312080</b>	12	I3	Ghiera bianca	<b>14,50</b>
<b>312075</b>	14	I3	Morsetto di allacciamento al vaso 50x40	<b>5,13</b>

**R** Contattare il Customer Service per tempistiche sulla disponibilità \* Ad esaurimento

**Ricambi cassetta incasso ÈLITE**

Codice	Classe	Descrizione	Conf.	Euro pZ.
<b>312034</b>	I2	Piastra di azionamento bianca doppio tasto	1	<b>92,58</b>
<b>R 312033</b>	I2	Piastra di azionamento cromata doppio tasto	1	<b>100,53</b>
<b>R 312098</b>	I2	Canotto/rosone per vaso pavimento	1	<b>18,03</b>

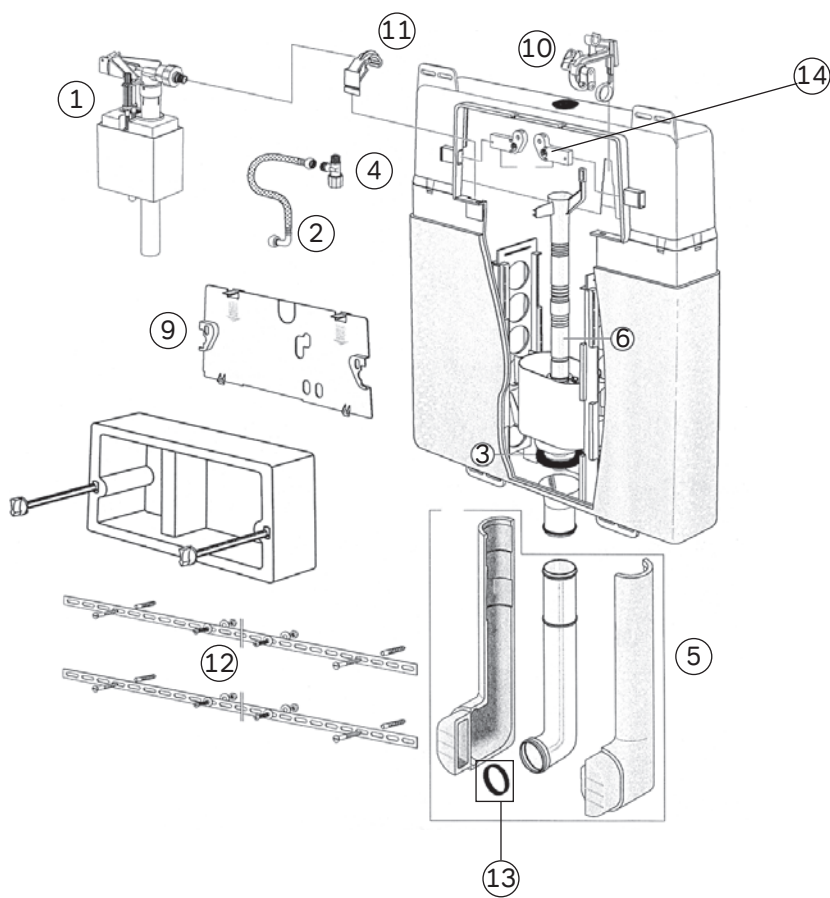

**N.B.:** Per trasformare una cassetta incasso ÈLITE da mono tasto a doppio tasto occorre cambiare la piastra di azionamento (cod. 312 034 o cod. 312 033) e sostituire anche l'ancora d'azionamento galleggiante (cod. 312 134).

Codice	Numero	Classe	Descrizione	Euro pz.
<b>312064</b>	1	I2	Rubinetto a galleggiante universale	<b>119,65</b>
R <b>312096</b>	2	I2	Flessibile per galleggiante	<b>14,95</b>
<b>312072</b>	3	I2	Guarnizione di fondo per valvola scarico	<b>12,95</b>
R <b>312106</b>	4	I2	Rubinetto di arresto 1/2"	<b>14,95</b>
R <b>312100</b>	5	I2	Tubo di cacciata Ø 45	<b>37,84</b>
<b>312102</b>	6	I2	Valvola di scarico	<b>79,21</b>
R <b>312110</b>			Polistirolo prot. piastra cass. incasso	<b>14,95</b>
R <b>312118</b>	8	I2	Set di fissaggio piastre	<b>25,07</b>
R <b>312094</b>	9	I2	Piastra protezione	<b>28,34</b>
<b>312133</b>	10	I2	Ancora azionamento galleggiante	<b>19,36</b>
<b>312134</b>	10 bis	I2	Ancora azionamento galleggiante+leva per piastra doppio tasto	<b>19,36</b>
R <b>312122</b>	11	I2	Piastra di supporto per rubinetto galleggiante	<b>10,21</b>
R <b>312124</b>			Supporto metallico fissaggio cass. muro	<b>22,83</b>
R <b>312128</b>	13	I2	Guarnizione tubo cacciata	<b>9,67</b>
R <b>312126</b>	14	I2	Set supporto di fissaggio	<b>6,63</b>
R <b>312120</b>	15	I2	Piastra fissaggio per leva piastra di azionamento	<b>11,07</b>

R Contattare il Customer Service per tempistiche sulla disponibilita



# Wavin PE 100



## Applicazioni

Il programma WAVIN per condotte in pressione in polietilene PE80 e PE100 a saldare, è un sistema composto da raccordi elettrosaldabili, pezzi speciali ed attrezzature, che lo rendono unico nel suo genere. Grazie alle nuove ed avanzate tecnologie con le quali vengono realizzati i raccordi, unita alla continua ricerca e sviluppo, il sistema Wavin ha assunto la sintesi ideale tra affidabilità, sicurezza e convenienza. Il programma WAVIN, viene usato in tutto il mondo ed in misura sempre più crescente per:

- Trasporto e distribuzione di gas combustibile (metano, GPL, ecc.)
- Trasporto e distribuzione acqua potabile (acquedotti) Fognature in pressione per usi industriali e civili
- Impianti di depurazione
- Impianti antincendio
- Sistemi di irrigazione centralizzati
- Piscine
- Condotte per aria compressa
- Condotte per impianti chimici
- Condotte per fluidi industriali
- Condotte per attraversamento di laghi e fiumi
- Condotte per scarichi in mare
- Relining (risanamento di vecchie reti)
- Condotte per convogliamento e trasporti d'inerti
- Impianti per trasporto di liquidi per l'alimentazione

I raccordi Monoline sono certificati e conformi ai requisiti delle norme tecniche ed igieniche e in particolare:

**Decreto 6 aprile 2004, n. 174.** Ministero della Salute. Regolamento concernente i materiali e gli oggetti che possono essere utilizzati negli impianti fissi di captazione, trattamento, adduzione e distribuzione delle acque destinate al consumo umano.

**Decreto 16 aprile 2008.** Regola tecnica per la progettazione, costruzione, collaudo, esercizio e sorveglianza delle opere e dei sistemi di distribuzione e di linee dirette del gas naturale con densità non superiore a 0,8.

**UNI EN 12201-3** (raccordi in polietilene per sistemi di tubazioni per il trasporto di acqua).

**UNI EN 1555-3** (raccordi in polietilene per sistemi di tubazioni per conduzione di gas combustibili).

**UNI EN ISO 15494** (raccordi in polietilene per sistemi di tubazioni per applicazioni industriali).

**UNI 9736** Giunzioni miste metallo-polietilene per condotte di gas combustibili, acqua e fluidi in pressione e/o metallo- polipropilene per condotte di acqua e fluidi in pressione.

**UNI 9034:** Condotte di distribuzione del gas con pressione massima di esercizio minore o uguale 0,5 MPa (5 bar) - Materiali e sistemi di giunzione

**UNI 9165:** Reti di distribuzione del gas - Condotte con pressione massima di esercizio minore o uguale a 5 bar - Progettazione, costruzione, collaudo, conduzione, manutenzione e risanamento

**UNI 9860:** Impianti di derivazione di utenza del gas - Progettazione, costruzione, collaudo, conduzione, manutenzione e risanamento.

**UNI 7129:** Impianti a gas per uso domestico e similari alimentati da rete di distribuzione

**UNI 9737:** Classificazione e qualificazione dei saldatori di materie plastiche - Saldatori con i procedimenti ad elementi termici per contatto con attrezzatura meccanica e a elettrofusione di tubi e raccordi in polietilene per il convogliamento di gas combustibili, di acqua e di altri fluidi in pressione.

**UNI 10521:** Saldatura di materie plastiche - Saldatura per elettrofusione - Saldatura di tubi e/o raccordi in polietilene per il trasporto di gas combustibili, di acqua e di altri fluidi in pressione.

**UNI 10566:** Saldatrici per elettrofusione ed attrezzature ausiliarie impiegate per l'esecuzione di giunzioni di tubi e/o raccordi in polietilene (PE), mediante raccordi elettrosaldabili, per il trasporto di gas combustibile, di acqua e di altri fluidi in pressione Caratteristiche e requisiti, collaudo, manutenzione e documenti.

La norma **UNI 10521** definisce il procedimento per la saldatura tramite elettrofusione, di tubi e/o raccordi in polietilene per il trasporto di gas combustibili, di acqua e di altri fluidi in pressione. L'esecuzione della saldatura deve avvenire in un luogo asciutto e in un campo di temperatura ambiente compresa tra -5°C e + 40 °C.

## **I RACCORDI WAVIN POSSONO ESSERE SALDATI IN UN CAMPO DI SALDATURA -10°C E +45°C.**

I laboratori WAVIN dedicano molti sforzi al miglioramento del valore qualitativo della saldatura con raccordi elettrosaldabili. La scelta su “raccordi a serraggio” cioè raccordi che fin dall’inizio hanno un contatto perfetto con il tubo e quindi un’immediata trasmissione del calore, produce una perfetta fusione molecolare alla giusta pressione e temperatura.

### **IN CASO DI INTERRUZIONE DELLA FASE DI SALDATURA (FUSION TIME), I RACCORDI WAVIN, PERMETTONO UN SECONDO CICLO DI SALDATURA. IL SECONDO CICLO DI SALDATURA, SI DEVE EFFETTUARE DOPO IL TEMPO DI RAFFREDDAMENTO (COOLING TIME) RIPORTATO SUL RACCORDO, OPPURE QUANDO IL RACCORDO HA RAGGIUNTO LA TEMPERATURA DEL MATERIALE BASE ADIACENTE**

Questa elasticità consente, durante la fase di fusione (FUSION TIME), una veloce e ottimale adesione tra le superfici interessate alla saldatura garantendo una pressione di saldatura eccezionalmente elevata ed adeguata alla reale necessità.

Gli innovativi indicatori di fusione, disegnati con una nuova geometria attenta al controllo del polietilene fuso all’interno del raccordo, fuoriescono dallo stesso per indicare l’avvenuto ciclo di fusione.

**ATTENZIONE:** la fuoriuscita degli indicatori di fusione non costituisce garanzia del buon esito della saldatura, ma solo come indicazione dell’avvenuta fusione del materiale

I raccordi elettrosaldabili WAVIN sono in grado di garantire la corretta esecuzione del processo di saldatura. È necessaria un’adeguata formazione tecnica ed attenersi alle norme di saldatura per elettrofusione.

- 1) verificare le dimensioni del tubo, diametro e ovalizzazione (devono rientrare nei limiti di accettabilità).
- 2) Tagliare con un tagliatubo WAVIN il tubo in squadra e marcarvi sopra l’area da raschiare (lunghezza di calettamento + 10 mm) utilizzando l’apposito pennarello o una matita cerosa
- 3) raschiare la superficie del tubo marcata, utilizzando il raschiatore manuale, ma preferibilmente utilizzare un raschiatore meccanico (l’utilizzo di carte abrasive è vietato)
- 4) pulire sempre la zona di tubo raschiata con l’apposito detergente per PE, e asciugare accuratamente senza lasciare residui. Marcare nuovamente la profondità di calettamento con l’apposito pennarello segnando su almeno un terzo della circonferenza delle estremità degli elementi da saldare, la loro profondità di inserimento nel raccordo.
- 5) allineare il tubo con il raccordo per mezzo degli allineatori. Non utilizzare questi strumenti significa esporsi al rischio di fallimento della saldatura.

Al termine della fase di saldatura (tempo di raffreddamento indicato sul raccordo o meglio freddo al tatto), rimuovere il giunto saldato dall’allineatore. Quando il raccordo è freddo controllare che non si siano modificati l’allineamento e la profondità d’inserimento. Controllare anche gli indicatori di fusione e che non vi sia fuoriuscita di materiale fuso tra gli elementi saldati.

**Manicotti elettrosaldabili Monoline PE 100**

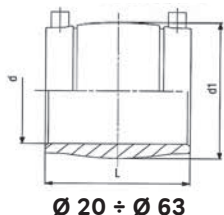

Codice	Classe	Fermo centrale rimovibile	d mm	d1 mm	L mm	L1 mm	L2 mm	SDR	peso kg	Conf.	Euro pz.
R <b>485700</b>	D3	sì	20	33	55			11	0,034	50	<b>10,11</b>
<b>485701</b>	D3	sì	25	39	55			11	0,042	50	<b>10,69</b>
<b>485702</b>	D3	sì	32	46	60			11	0,051	50	<b>10,96</b>
<b>485703</b>	D3	sì	40	56	65			11	0,077	50	<b>11,16</b>
<b>485704</b>	D3		50	69	75			11	0,125	50	<b>16,53</b>
<b>485705</b>	D3		63	82	80			11	0,165	42	<b>17,96</b>
<b>485706</b>	D3	sì	75	96	110			11 - 17/17.6	0,282	12	<b>27,72</b>
<b>485710</b>	D3	sì	90	113	125			11 - 17/17.6	0,406	10	<b>35,21</b>
<b>485730</b>	D3	sì	110	138	145			11 - 17/17.6	0,670	6	<b>42,65</b>
<b>485715</b>	D3	sì	125	154	158			11 - 17/17.6	0,758	5	<b>58,75</b>
<b>485716</b>	D3	sì	140	172	168			11 - 17/17.6	0,962	5	<b>67,19</b>
<b>485717</b>	D3	sì	160	195	180			11 - 17/17.6	1,367	6	<b>78,04</b>
<b>485718</b>	D3		180	219	194			11 - 17/17.6	1,811	5	<b>130,08</b>
<b>485719</b>	D3		200	244	208			11 - 17/17.6	2,333	4	<b>132,63</b>
<b>485720</b>	D3		225	273	224			11 - 17/17.6	3,334	3	<b>163,20</b>
<b>485725</b>	D3		250	304	244			11 - 17/17.6	4,210	2	<b>243,21</b>
R <b>485729</b>	D3		315	382	268			11 - 17/17.6	7,955	1	<b>393,68</b>

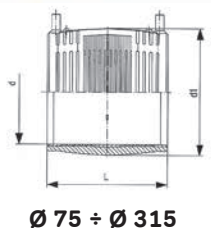

- Terminali raccordi Ø 4 mm.
- Indicatori di fusione con fuoriuscita controllata
- Bar-code saldatura modello interleaved 2.5 (ISO 13950)
- Acqua PFA/PN 16 - GAS MOP 5
- Tensione di saldatura 40 V

R Contattare il Customer Service per tempistiche sulla disponibilità



**Gomiti elettrosaldabili 90° Monoline PE 100**

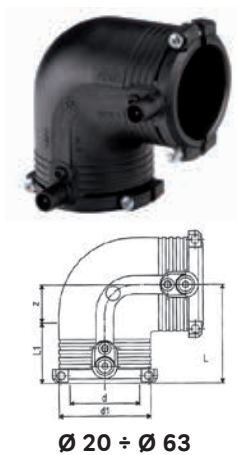

Codice	Classe	d mm	d1 mm	L mm	L1 mm	L2 mm	z mm	SDR	peso kg	Conf.	Euro pz.
R <b>485811</b>	D3	20	35	54	34		20	11	0,086	40	<b>28,16</b>
<b>485812</b>	D3	25	35	54	34		20	11	0,065	40	<b>28,88</b>
<b>485813</b>	D3	32	44	53	36		17	11	0,085	35	<b>29,80</b>
<b>485814</b>	D3	40	54	62	39		23	11	0,136	30	<b>33,69</b>
<b>485815</b>	D3	50	66	71	43		28	11	0,197	30	<b>45,01</b>
<b>485816</b>	D3	63	81	81	48		32	11	0,311	18	<b>51,28</b>

- Terminali di saldatura 4mm.
- Indicatori di fusione con fuoriuscita controllata
- Sistema di pre-fissaggio integrato al raccordo
- Bar-code saldatura modello interleaved 2.5 (ISO 13950)
- Acqua PFA/PN 16 - GAS MOP 5
- Tensione di saldatura 40 V



Codice	Classe	d mm	d1 mm	L mm	L1 mm	L2 mm	z mm	SDR	peso kg	Conf.	Euro pz.
<b>485801</b>	D3	75	97	94	54		40	11	0,413	25	<b>73,84</b>
<b>485617</b>	D3	90	115	122	62		60	11	0,827	15	<b>87,10</b>
<b>485618</b>	D3	110	140	147	72		76	11-17/17.6	1,265	8	<b>126,03</b>
<b>485819</b>	D3	125	161	155	78		77	11-17/17.6	1,742	5	<b>170,47</b>
<b>485820</b>	D3	160	208	193	89		104	11-17/17.6	3,845	4	<b>299,40</b>
R <b>485856</b>	D3	180	234	213	96		117	11-17/17.6	5,342	3	<b>365,78</b>

- Terminali di saldatura 4mm.
- Indicatori di fusione con fuoriuscita controllata
- Bar-code saldatura modello interleaved 2.5 (ISO 13950)
- Acqua PFA/PN 16 - GAS MOP 5
- Tensione di saldatura 40 V

Codice	Classe	d mm	d1 mm	L mm	L1 mm	L2 mm	z mm	SDR mm	peso kg	Conf.	Euro pz.
--------	--------	------	-------	------	-------	-------	------	--------	---------	-------	----------



R <b>485854</b>	D3	200	250	298	104		194	11-17/17.6	7,987	1	<b>845,71</b>
R <b>485858</b>	D3	225	280	318	112		206	11-17/17.6	11,220	1	<b>1.053,51</b>
R <b>485859</b>	D3	250	310	347	123		224	11-17/17.6	15,715	1	<b>1.319,91</b>

- Terminali di saldatura 4mm.
- Indicatori di fusione con fuoriuscita controllata
- Saldatura bifilare
- Bar-code saldatura modello interleaved 2.5 (ISO 13950)
- Acqua PFA/PN 16 - GAS MOP 5
- Tensione di saldatura 40V

R Contattare il Customer Service per tempistiche sulla disponibilita



**Gomiti elettrosaldabili 45° Monoline PE 100**

Codice	Classe	d mm	d1 mm	L mm	L1 mm	L2 mm	z mm	SDR	peso kg	Conf.	Euro pz.
<b>485803</b>	D3	32	44	44	36		8	11	0,074	35	<b>32,54</b>
<b>485804</b>	D3	40	54	50	36		11	11	0,113	25	<b>33,96</b>
<b>485805</b>	D3	50	66	56	43		13	11	0,158	30	<b>46,28</b>
<b>485806</b>	D3	63	81	63	48		15	11	0,258	24	<b>52,32</b>

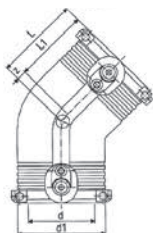

Ø 32 ÷ Ø 63

- Terminali di saldatura 4mm.
- Indicatori di fusione con fuoriuscita controllata
- Sistema di pre-fissaggio integrato al raccordo
- Bar-code saldatura modello interleaved 2.5 (ISO 13950)
- Acqua PFA/PN 16 - GAS MOP 5
- Tensione di saldatura 40 V



Codice	Classe	d mm	d1 mm	L mm	L1 mm	L2 mm	z mm	SDR	peso kg	Conf.	Euro pz.
<b>485800</b>	D3	75	97	71	54		17	11	0,346	25	<b>73,84</b>
<b>485620</b>	D3	90	115	91	62		29	11	0,557	20	<b>88,25</b>
<b>485621</b>	D3	110	140	112	72		40	11-17/17.6	0,973	12	<b>127,29</b>
<b>485809</b>	D3	125	160	119	78		41	11-17/17.6	1,466	6	<b>171,86</b>
<b>485810</b>	D3	160	208	134	89		42	11-17/17.6	3,005	5	<b>304,63</b>
<b>R 485796</b>	D3	180	234	142	96		47	11-17/17.6	4,047	4	<b>366,54</b>

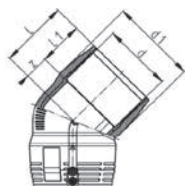

Ø 75 ÷ Ø 180

- Terminali di saldatura 4mm.
- Indicatori di fusione con fuoriuscita controllata
- Bar-code saldatura modello interleaved 2.5 (ISO 13950)
- Acqua PFA/PN 16 - GAS MOP 5
- Tensione di saldatura 40 V



Codice	Classe	d mm	d1 mm	L mm	L1 mm	L2 mm	z mm	SDR	peso kg	Conf.	Euro pz.
<b>R 485849</b>	D3	200	250	232	104		128	11-17/17.6	7,578	1	<b>845,71</b>
<b>* 485851</b>	D3	225	280	247	112		135	11-17/17.6	9,540	1	<b>1.043,32</b>
<b>R 485853</b>	D3	250	310	275	123		152	11-17/17.6	12,740	1	<b>1.319,91</b>

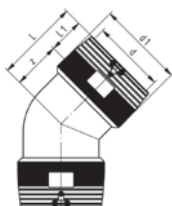

Ø 200 ÷ Ø 250

- Terminali di saldatura 4mm.
- Indicatori di fusione con fuoriuscita controllata
- Saldatura bifilare
- Bar-code saldatura modello interleaved 2.5 (ISO 13950)
- Acqua PFA/PN 16 - GAS MOP 5
- Tensione di saldatura 40V

R Contattare il Customer Service per tempistiche sulla disponibilità

\* Ad esaurimento



**Tee elettrosaldabili Monoline PE 100**

Codice	Classe	d mm	d1 mm	L mm	L1 mm	z mm	z1 mm	H mm	SDR	peso kg	Conf.	Euro pz.
<b>485821</b>	D3	20	35	90	34	11	92	67	11	0,090	40	<b>31,31</b>
<b>485822</b>	D3	25	35	90	34	11	92	70	11	0,075	40	<b>31,48</b>
<b>485823</b>	D3	32	44	102	36	15	100	74	11	0,109	35	<b>32,91</b>
<b>485824</b>	D3	40	54	120	39	21	114	82	11	0,175	30	<b>43,43</b>
<b>485825</b>	D3	50	66	135	43	24	126	90	11	0,262	22	<b>47,95</b>
<b>485826</b>	D3	63	81	152	48	28	150	102	11	0,420	12	<b>51,53</b>

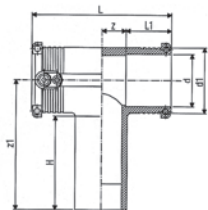

Ø 20 ÷ Ø 63

- Terminali di saldatura 4mm.
- Indicatori di fusione con fuoriuscita controllata
- Sistema di pre-fissaggio integrato al raccordo
- Bar-code saldatura modello interleaved 2.5 (ISO 13950)
- Acqua PFA/PN 16 - GAS MOP 5
- Tensione di saldatura 40 V



Codice	Classe	d mm	d1 mm	L mm	L1 mm	z mm	z1 mm	H mm	SDR	peso kg	Conf.	Euro pz.
<b>485802</b>	D3	75	97	178	54	35	143	87	11	0,566	18	<b>78,05</b>
<b>485623</b>	D3	90	115	205	62	41	161	94	11	0,887	10	<b>89,74</b>
<b>485624</b>	D3	110	140	255	72	56	184	104	11-17/17.6	1,608	6	<b>127,66</b>
<b>485829</b>	D3	125	151	276	78	60	207	113	11-17/17.6	2,251	4	<b>171,11</b>
<b>485830</b>	D3	160	210	330	89	76	220	105	11-17/17.6	5,000	3	<b>289,09</b>
<b>485857</b>	D3	180	233	350	96	79	247	120	11-17/17.6	6,050	2	<b>405,66</b>



Ø 75 ÷ Ø 180

- Terminali di saldatura 4mm.
- Indicatori di fusione con fuoriuscita controllata
- Bar-code saldatura modello interleaved 2.5 (ISO 13950)
- Acqua PFA/PN 16 - GAS MOP 5
- Tensione di saldatura 40 V

R Contattare il Customer Service per tempistiche sulla disponibilita

**Tee elettrosaldabili Monoline PE110**

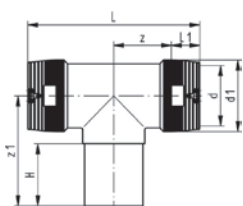

Ø 200 ÷ Ø 250

	Codice	Classe	d mm	d1 mm	L mm	L1 mm	z mm	z1 mm	H mm	SDR	peso kg	Conf.	Euro pz.
R	<b>485777</b>	D3	200	250	590	104	191	250	117	11-17/17.6	10,420	1	<b>844,82</b>
*	<b>485779</b>	D3	250	310	685	123	220	288	127	11-17/17.6	19,245	1	<b>1.393,81</b>

- Terminali di saldatura 4mm.
- Indicatori di fusione con fuoriuscita controllata
- Saldatura bifilare
- Bar-code saldatura modello interleaved 2.5 (ISO 13950)
- Acqua PFA/PN 16 - GAS MOP 5
- Tensione di saldatura 40V

**Tee elettrosaldabili ridotti Monoline PE100**

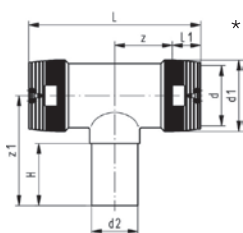

	Codice	Classe	d mm	d2 mm	d1 mm	L mm	L1 mm	z mm	z1 mm	H mm	SDR	peso kg	Conf.	Euro pz.
R	<b>485771</b>	D3	160	63	200	493	90	127	176	65	11-17/17.6	4,940	1	<b>770,67</b>
R	<b>485772</b>	D3	160	90	200	492	90	158	188	79	11-17/17.6	5,040	2	<b>780,86</b>
R	<b>485630</b>	D3	200	90	250	595	104	194	215	81	11-17/17.6	11,260	1	<b>1.402,73</b>
*	<b>485774</b>	D3	225	90	280	666	112	217	226	80	11-17/17.6	12,700	1	<b>1.616,77</b>
*	<b>485775</b>	D3	225	110	280	670	112	217	235	85	11-17/17.6	12,750	1	<b>1.616,77</b>
*	<b>485776</b>	D3	225	160	280	667	112	217	255	105	11-17/17.6	12,951	1	<b>1.616,77</b>
	<b>485640</b>	D3	250	160	310	711	123	220	264	101	11-17/17.6	12,750	1	<b>1.876,68</b>

- Terminali di saldatura 4mm.
- Indicatori di fusione con fuoriuscita controllata
- Saldatura bifilare
- Bar-code saldatura modello interleaved 2.5 (ISO 13950)
- Acqua PFA/PN 16 - GAS MOP 5
- Tensione di saldatura 40V

R Contattare il Customer Service per tempistiche sulla disponibilità

\* Ad esaurimento

**Riduzioni elettrosaldabili Monoline PE 100**

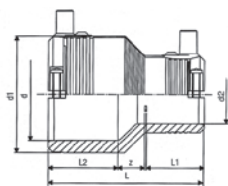

	Codice	Classe	d-d2 mm	d1 mm	L mm	L1 mm	L2 mm	z mm	SDR	peso kg	Conf.	Euro pz.
R	<b>485831</b>	D3	25-20	35	74	34	34	6	11	0,054	40	<b>17,34</b>
R	<b>485832</b>	D3	32-20	44	79	33	36	10	11	0,066	35	<b>17,83</b>
	<b>485833</b>	D3	32-25	44	79	33	36	10	11	0,060	35	<b>17,55</b>
	<b>485835</b>	D3	40-32	54	88	33	39	13	11	0,090	40	<b>27,93</b>
	<b>485837</b>	D3	50-32	66	96	35	43	18	11	0,113	35	<b>32,66</b>
	<b>485838</b>	D3	50-40	66	96	39	43	14	11	0,117	32	<b>35,39</b>
	<b>485839</b>	D3	63-32	81	106	35	48	23	11	0,164	40	<b>39,22</b>
	<b>485840</b>	D3	63-40	81	106	39	48	19	11	0,166	40	<b>39,22</b>
	<b>485841</b>	D3	63-50	81	106	43	48	15	11	0,183	40	<b>39,22</b>

**Ø 25-20 ÷ Ø 63-50**

- Terminali di saldatura 4mm.
- Indicatori di fusione con fuoriuscita controllata
- Sistema di pre-fissaggio integrato al raccordo
- Bar-code saldatura modello interleaved 2.5 (ISO 13950)
- Acqua PFA/PN 16 - GAS MOP 5
- Tensione di saldatura 40 V

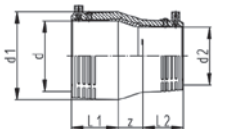

	Codice	Classe	d-d2 mm	d1 mm	L mm	L1 mm	L2 mm	z mm	SDR	peso kg	Conf.	Euro pz.
	<b>485627</b>	D3	90-63	113	74	63	47	36	11-17/17.6	0,370	12	<b>62,17</b>
	<b>485629</b>	D3	110-63	140	184	71	58	55	11-17/17,6	0,600	16	<b>77,40</b>
	<b>485628</b>	D3	110-90	138	79	73	63	38	11-17/17.6	0,657	16	<b>88,65</b>
	<b>485848</b>	D3	125-90	152	79	79	61	40	11-17/17.6	0,878	12	<b>136,45</b>
	<b>485847</b>	D3	160-90	202	227	90	72	65	11	1,600	5	<b>150,59</b>
	<b>485850</b>	D3	160-110	196	88	91	70	65	11-17/17.6	1,668	5	<b>172,00</b>
R	<b>485852</b>	D3	180-125	220	88	97	70	80	11-17/17.6	2,049	4	<b>213,40</b>

**Ø 90-63 ÷ Ø 180-125**

- Terminali di saldatura 4mm.
- Indicatori di fusione con fuoriuscita controllata
- Sistema di pre-fissaggio integrato al raccordo
- Bar-code saldatura modello interleaved 2.5 (ISO 13950)
- Acqua PFA/PN 16 - GAS MOP 5
- Tensione di saldatura 40 V

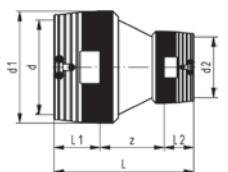

	Codice	Classe	d-d2 mm	d1 mm	L mm	L1 mm	L2 mm	z mm	SDR	peso kg	Conf.	Euro pz.
*	<b>485842</b>	D3	200-160	250	365	104	90	171	11-17/17.6	5,049	1	<b>615,75</b>
*	<b>485843</b>	D3	225-160	280	385	112	90	183	11-17/17.6	5,997	1	<b>849,79</b>
R	<b>485845</b>	D3	250-200	310	427	123	104	200	11-17/17.6	8,686	2	<b>1.027,52</b>

- Terminali di saldatura 4mm.
- Indicatori di fusione con fuoriuscita controllata
- Saldatura bifilare
- Bar-code saldatura modello interleaved 2.5 (ISO 13950)
- Acqua PFA/PN 16 - GAS MOP 5
- Tensione di saldatura 40V

**Ø 200-160 ÷ Ø 250-200**

R Contattare il Customer Service per tempistiche sulla disponibilità

\* Ad esaurimento

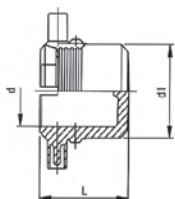

Ø 20 ÷ Ø 63

**Fine linea elettrosaldabili Monoline PE 100**

	Codice	Classe	d mm	d1 mm	L mm	L1 mm	L2 mm	z mm	SDR	peso kg	Conf.	Euro pz.
R	<b>485931</b>	D3	25	35	52	44			11	0,042	30	<b>19,30</b>
	<b>485932</b>	D3	32	44	52	44			11	0,054	50	<b>20,82</b>
R	<b>485933</b>	D3	40	54	56	47			11	0,072	50	<b>22,80</b>
R	<b>485934</b>	D3	50	66	60	49			11	0,099	30	<b>30,07</b>
	<b>485935</b>	D3	63	81	66	54			11	0,150	20	<b>37,73</b>

- Terminali di saldatura 4mm.
- Indicatori di fusione con fuoriuscita controllata
- Sistema di pre-fissaggio integrato al raccordo
- Bar-code saldatura modello interleaved 2.5 (ISO 13950)
- Acqua PFA/PN 16 - GAS MOP 5
- Tensione di saldatura 40 V

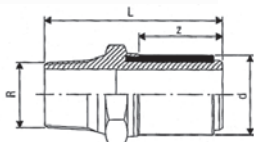

**Niplo maschio per raccordi elettrosaldabili (Gomiti - Tee - Riduzioni) Monoline PE100**

	Codice	Classe	d mm	R "	L mm	s mm	L2 mm	z mm	SDR	peso kg	Conf.	Euro pz.
R	<b>485860</b>	D3	20	1/2	75			33	11	0,127	50	<b>43,41</b>
	<b>485861</b>	D3	25	3/4	76			33	11	0,182	40	<b>41,62</b>
	<b>485862</b>	D3	32	1	80			35	11	0,256	30	<b>41,44</b>
	<b>485863</b>	D3	40	1 1/4	86			39	11	0,410	20	<b>52,98</b>
R	<b>485885</b>	D3	50	1	88			43	11	0,463	20	<b>70,32</b>
R	<b>485884</b>	D3	50	1 1/4	90			43	11	0,539	20	<b>70,32</b>
	<b>485864</b>	D3	50	1 1/2	90			43	11	0,508	20	<b>54,68</b>
R	<b>485886</b>	D3	63	1 1/4	94			47	11	0,702	12	<b>89,91</b>
	<b>485865</b>	D3	63	2	98			47	11	0,776	12	<b>76,07</b>

Filettatura esterna conica a tenuta sul filetto UNI 10226

Da utilizzarsi con raccordi elettrosaldabili Monoline (tutti i diametri) o Rollmaplast (solamente per diametri ≥ 40).

R Contattare il Customer Service per tempistiche sulla disponibilita

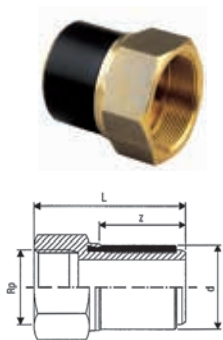

**Nipplo femmina per raccordi elettrosaldabili (Gomiti - Tee - Riduzioni) Monoline PE100**

Codice	Classe	d mm	Rp "	L mm	s mm	L2 mm	z mm	SDR	peso kg	Conf.	Euro pz.
<b>485866</b>	D3	32	1	71			35	11	0,244	30	<b>46,53</b>
<b>485867</b>	D3	40	1 1/4	77			39	11	0,387	24	<b>57,27</b>
<b>485868</b>	D3	50	1 1/2	81			43	11	0,593	20	<b>62,38</b>
<b>R 485972</b>	D3	63	1	89			47	11	1,071	12	<b>92,41</b>
<b>R 485973</b>	D3	63	1 1/4	89			47	11	1,017	12	<b>92,41</b>
<b>R 485974</b>	D3	63	1 1/2	89			47	11	0,938	12	<b>92,41</b>
<b>485869</b>	D3	63	2	89			47	11	0,842	12	<b>88,90</b>

Rp: Filettatura interna cilindrica a tenuta sul filetto UNI EN 10226

**Collari di presa con derivazione ortogonale PE 100**



Codice	Classe	d mm	d1 mm	d2 mm	H mm	H1 mm	L mm	SW mm	SDR	peso kg	Conf.	Euro pz.
<b>R 489287</b>	D3	63	32	19	145	50	165	13	11	0,469	5	<b>57,02</b>
<b>R 489010</b>	D3	63	63	32	152	50	165	17	11	1,036	5	<b>67,39</b>
<b>R 489288</b>	D3	75	32	19	151	50	165	13	11	0,618	5	<b>62,36</b>
<b>R 489011</b>	D3	75	63	32	158	50	165	17	11	1,166	5	<b>77,93</b>
<b>489003</b>	D3	90	63	32	165	50	165	17	11	1,128	5	<b>77,93</b>
<b>* 489012</b>	D3	110	32	19	168	50	165	13	11	0,607	1	<b>71,78</b>
<b>489005</b>	D3	110	63	32	175	50	165	17	11	1,195	3	<b>80,94</b>
<b>489007</b>	D3	125	63	32	183	50	165	17	11	1,224	1	<b>92,95</b>
<b>R 489015</b>	D3	160	32	19	193	50	165	13	11	0,652	5	<b>138,48</b>
<b>R 489009</b>	D3	160	63	32	200	50	165	17	11	1,186	5	<b>138,48</b>
<b>* 489018</b>	D3	180	63	32	210	50	165	17	11 - 26	1,316	1	<b>143,46</b>
<b>* 489294</b>	D3	200	32	19	213	50	165	13	11 - 26	0,854	1	<b>207,17</b>
<b>* 489025</b>	D3	315 - 355	63	35	245	50	165	17	17 - 33	1,094	1	<b>295,07</b>

- Terminali di saldatura 4mm.
- Indicatori di fusione con fuoriuscita controllata
- Per diametri 280 mm, 315-355 installazione tramite posizionatore Topload cod 488840
- Bar-code saldatura modello interleaved 2.5 (ISO 13950)
- Acqua PFA/PN 16 - GAS MOP 5
- Tensione di saldatura 40V

R Contattare il Customer Service per tempistiche sulla disponibilita

\* Ad esaurimento



**Collare di presa in carico con derivazione laterale PE 100**

Codice	Classe	d mm	d1 mm	d2 mm	L mm	L1 mm	H mm	H1 mm	z mm	SDR	peso kg	Conf.	Euro pz.
* <b>489201</b>	D3	40	25	16	103	70	99	33	102	11	0,226	6	<b>79,21</b>
<b>R 489202</b>	D3	40	32	16	103	70	99	33	120	11	0,225	1	<b>79,21</b>
<b>R 489204</b>	D3	50	25	16	103	70	104	38	102	11	0,212	5	<b>80,59</b>
<b>R 489205</b>	D3	50	32	16	103	70	104	38	120	11	0,228	5	<b>80,59</b>

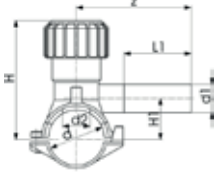

L = length / Länge

- Terminali di saldatura 4mm.
- Indicatori di fusione con fuoriuscita controllata
- Bar-code saldatura modello interleaved 2.5 (ISO 13950)
- Acqua PFA/PN 16 - GAS MOP 5
- Tensione di saldatura 40V

**Collari di presa in carico con derivazione laterale Monoline PE 100**



Codice	Classe	d mm	d1 mm	d2 mm	L mm	L1 mm	H mm	H1 mm	z mm	SDR	peso kg	Conf.	Euro pz.
<b>R 489209</b>	D3	63	32	25	144	76	146	44	110	11	0,398	20	<b>83,52</b>
<b>489223</b>	D3	90	32	32	162	76	198	61	115	11-17.6	0,538	12	<b>95,96</b>
<b>R 489224</b>	D3	90	40	32	162	57	198	61	197	11-17.6	0,450	10	<b>99,31</b>
<b>R 489225</b>	D3	90	50	32	162	63	198	61	203	11-17.6	0,450	10	<b>106,06</b>
<b>R 489226</b>	D3	90	63	32	162	76	198	61	115	11-17.6	0,450	12	<b>104,32</b>
<b>R 489231</b>	D3	110	25	32	162	76	208	71	115	11-17.6	0,570	9	<b>102,81</b>
<b>489232</b>	D3	110	32	32	162	76	208	71	125	11-17.6	0,580	9	<b>106,97</b>
<b>R 489235</b>	D3	110	50	32	162	63	208	71	203	11-17.6	0,600	8	<b>109,20</b>
* <b>489236</b>	D3	110	63	32	162	100	208	71	125	11-17.6	0,600	8	<b>103,25</b>
<b>R 489239</b>	D3	125	25	32	162	76	216	79	120	11-17.6	0,568	6	<b>113,80</b>
<b>R 489240</b>	D3	125	32	32	162	76	216	79	120	11-17.6	0,597	6	<b>124,09</b>
<b>R 489237</b>	D3	125	63	32	162	76	216	79	120	11-17.6	0,597	6	<b>126,28</b>
<b>R 489244</b>	D3	160	25	32	162	76	233	96	125	11-17.6	0,640	6	<b>155,56</b>
<b>R 489245</b>	D3	160	32	32	162	76	233	96	130	11-17.6	0,671	6	<b>155,56</b>
* <b>489254</b>	D3	160	63	32	162	100	233	96	170	11-17.6	0,790	6	<b>160,66</b>

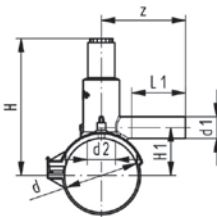

- Terminali di saldatura 4 mm
- Indicatori di fusione con fuoriuscita controllata
- Bar-code saldatura modello interleaved 2.5 (ISO 13950)
- Acqua PFA/PN 16 - GAS MOP 5
- Tensione di saldatura 40V

R Contattare il Customer Service per tempistiche sulla disponibilità

\* Ad esaurimento



**Collare di presa in carico con derivazione laterale orientabile 360° PE 100**



Codice	Classe	d mm	d1 mm	d2 mm	L mm	L1 mm	H mm	H1 mm	z mm	SDR mm	peso kg	Conf.	Euro pz.
R <b>489260</b>	D3	63	40	32	165	81	186	108	137	11	0,718	1	<b>93,84</b>
R <b>489263</b>	D3	75	32	32	165	76	191	113	130	11	0,812	1	<b>100,79</b>
<b>489269</b>	D3	180	32	32	165	76	244	166	130	11 - 26	0,957	3	<b>150,47</b>
R <b>489276</b>	D3	200	63	35	165	100	303	181	160	11 - 26	1,745	1	<b>191,36</b>
<b>489279</b>	D3	225	32	32	165	76	266	188	130	11 - 26	1,019	3	<b>210,22</b>
<b>489284</b>	D3	250	32	32	165	76	279	201	130	11 - 26	0,996	1	<b>275,71</b>
<b>489286</b>	D3	250	63	35	165	100	328	206	160	11 - 26	1,733	1	<b>262,07</b>

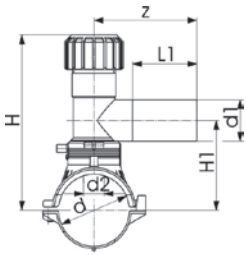

- Terminali di saldatura 4mm.
- Indicatori di fusione con fuoriuscita controllata
- Bar-code saldatura modello interleaved 2.5 (ISO 13950)
- Acqua PFA/PN 16 - GAS MOP 5
- Tensione di saldatura 40V

R Contattare il Customer Service per tempistiche sulla disponibilita



**Gomiti 90° (Tipo L) PE 100 PN 16 MOP 5 SDR 11**

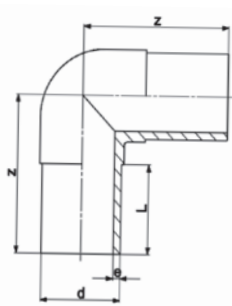

	Codice	Classe	d mm	d1 mm	L mm	e mm	z mm	peso kg	Conf.	Euro pz.
R	<b>480221</b>	D3	25		52	3,0	80	0,037	40	<b>6,73</b>
	<b>480222</b>	D3	32		54	3,0	85	0,056	100	<b>7,15</b>
	<b>480223</b>	D3	40		57	3,7	95	0,095	50	<b>8,58</b>
	<b>480224</b>	D3	50		63	4,6	105	0,159	30	<b>11,53</b>
	<b>480225</b>	D3	63		65	5,8	115	0,275	40	<b>19,69</b>
	<b>480226</b>	D3	75		72	6,8	130	0,413	12	<b>26,01</b>
	<b>480227</b>	D3	90		81	8,2	150	0,704	18	<b>31,35</b>
	<b>480228</b>	D3	110		86	10,0	165	1,145	10	<b>58,12</b>
R	<b>480229</b>	D3	125		93	11,4	180	1,609	8	<b>79,78</b>
	<b>480230</b>	D3	140		92	12,7	202	1,950	5	<b>102,51</b>
	<b>480231</b>	D3	160		103	14,6	210	3,100	5	<b>117,93</b>
R	<b>480232</b>	D3	180		107	16,4	232	4,319	3	<b>140,78</b>
R	<b>480233</b>	D3	200		117	18,2	253	5,733	3	<b>214,67</b>
	<b>480235</b>	D3	250		130	22,7	292	10,512	1	<b>463,50</b>
R	<b>480237</b>	D3	315		150	28,6	370	21,960	1	<b>938,08</b>

**Gomiti 45° (Tipo L) PE 100 PN 16 MOP 5 SDR 11**

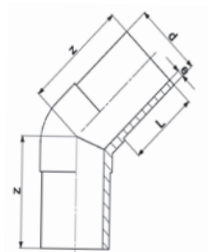

	Codice	Classe	d mm	d1 mm	L mm	e mm	z mm	peso kg	Conf.	Euro pz.
R	<b>480203</b>	D3	40		57	3,7	85	0,082	30	<b>9,71</b>
R	<b>480204</b>	D3	50		63	4,6	90	0,137	70	<b>10,87</b>
	<b>480205</b>	D3	63		65	5,8	95	0,300	50	<b>19,30</b>
	<b>480206</b>	D3	75		72	6,8	105	0,346	12	<b>26,22</b>
	<b>480207</b>	D3	90		81	8,2	120	0,578	20	<b>29,31</b>
	<b>480208</b>	D3	110		86	10,0	130	0,931	12	<b>54,10</b>
	<b>480209</b>	D3	125		92	11,4	140	1,310	8	<b>79,60</b>
R	<b>480210</b>	D3	140		120	12,7	164	1,796	4	<b>98,08</b>
	<b>480211</b>	D3	160		102	14,6	162	2,448	6	<b>107,60</b>
R	<b>480212</b>	D3	180		107	16,4	186	3,283	5	<b>130,46</b>
R	<b>480213</b>	D3	200		116	18,2	185	4,371	3	<b>177,22</b>
R	<b>485214</b>	D3	225		123	20,5	200	6,013	2	<b>234,55</b>
R	<b>480215</b>	D3	250		130	22,7	220	8,541	3	<b>409,48</b>
R	<b>485217</b>	D3	315		150	28,6	250	14,124	2	<b>848,39</b>

R Contattare il Customer Service per tempistiche sulla disponibilita

**Tee 90° (Tipo L) PE 100 PN 16 MOP 5 SDR 11**

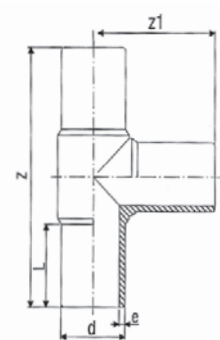
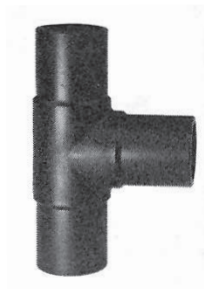

Codice	Classe	d mm	d1 mm	L mm	H mm	e mm	z mm	z1 mm	peso kg	Conf.	Euro pz.
R <b>480242</b>	D3	32		54		3,0	170	85	0,073	20	<b>9,78</b>
<b>480243</b>	D3	40		57		3,7	190	95	0,129	80	<b>11,57</b>
<b>480244</b>	D3	50		63		4,6	210	105	0,217	20	<b>14,69</b>
<b>480245</b>	D3	63		65		5,8	230	115	0,420	25	<b>20,10</b>
<b>480246</b>	D3	75		72		6,8	264	132	0,604	16	<b>29,93</b>
<b>480247</b>	D3	90		81		8,2	300	150	1,031	7	<b>46,87</b>
<b>480248</b>	D3	110		86		10,0	330	165	1,616	7	<b>66,70</b>
<b>480249</b>	D3	125		92		11,4	366	183	2,386	4	<b>95,28</b>
R <b>480250</b>	D3	140		92		12,7	396	196	3,200	3	<b>135,18</b>
<b>480251</b>	D3	160		102		14,6	420	210	4,323	4	<b>168,43</b>
* <b>480252</b>	D3	180		107		16,4	460	230	6,030	3	<b>231,49</b>
<b>480253</b>	D3	200		117		18,2	500	250	8,500	2	<b>347,31</b>
* <b>480255</b>	D3	250		130		22,7	575	288	14,708	2	<b>757,93</b>
R <b>480257</b>	D3	315		150		28,6	695	346	26,150	1	<b>1.428,21</b>

**Tee ridotti Tipo L PE 100 PN16 MOP 5 SDR 11 (segue)**

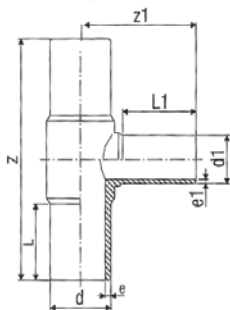

Codice	Classe	d mm	d1 mm	L mm	L1 mm	z mm	z1 mm	e mm	e1 mm	peso kg	Conf.	Euro pz.
<b>480333</b>	D3	90	63	79	64	269	136	8,2	5,8	0,775	10	<b>81,21</b>
<b>480335</b>	D3	110	63	84	65	309	156	10,0	5,8	1,267	10	<b>116,17</b>
R <b>480336</b>	D3	110	75	82	70	309	151	10,0	6,9	1,235	10	<b>129,70</b>
R <b>480337</b>	D3	110	90	82	70	309	151	10,0	6,9	1,275	10	<b>142,44</b>
R <b>480340</b>	D3	125	110	88	82	341	170	11,4	10,0	2,389	3	<b>133,77</b>
R <b>485516</b>	D3	160	63	98	65	340	176	14,6	5,8	2,680	3	<b>357,76</b>
R <b>480354</b>	D3	160	75	98	74	340	180	14,6	6,9	2,717	2	<b>326,29</b>
R <b>480355</b>	D3	160	90	98	79	410	180	14,6	8,2	3,775	5	<b>326,29</b>
R <b>480342</b>	D3	160	110	98	82	420	265	14,6	10,0	4,060	8	<b>327,43</b>
* <b>485056</b>	D3	200	63	122	63	500	190	18,2	5,8	7,300	3	<b>667,73</b>
* <b>485057</b>	D3	200	90	120	81	503	215	18,2	8,2	9,730	1	<b>594,34</b>
* <b>485058</b>	D3	200	110	120	84	503	218	18,2	10,0	9,730	4	<b>637,28</b>
<b>485059</b>	D3	200	160	120	101	503	236	18,2	14,6	9,730	4	<b>650,65</b>

R Contattare il Customer Service per tempistiche sulla disponibilita

\* Ad esaurimento

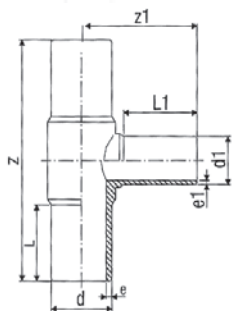

**Tee ridotti Tipo L PE 100 PN16 MOP 5 SDR 11 (continua)**

Codice	Classe	d mm	d1 mm	L mm	L1 mm	z mm	z1 mm	e mm	e1 mm	peso kg	Conf.	Euro pz.
* <b>485062</b>	D3	250	110	132	85	586	245	22,7	10,0	11,878	2	<b>1.252,26</b>
R <b>485063</b>	D3	250	160	132	101	586	264	22,7	14,6	9,730	2	<b>1.252,26</b>
* <b>485065</b>	D3	315	160	150	102	695	296	28,6	14,6	22,998	1	<b>1.290,61</b>
R <b>485066</b>	D3	315	225	170	145	650	335	28,6	20,5	20,011	1	<b>1.285,52</b>
<b>485067</b>	D3	315	250	150	130	695	325	28,6	22,7	24,243	1	<b>1.285,52</b>

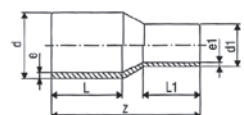

**Riduzioni (Tipo L) PE 100 PN 16 MOP 5 SDR 11 (segue)**

Codice	Classe	d mm	d1 mm	L mm	L1 mm	z mm	e mm	e1 mm	peso kg	Conf.	Euro pz.
<b>480288</b>	D3	50	32	63	53	140	4,6	3,0	0,071	40	<b>8,94</b>
R <b>480289</b>	D3	50	40	63	57	140	4,6	3,7	0,083	25	<b>8,94</b>
<b>480290</b>	D3	63	32	65	53	150	5,8	3,0	0,109	50	<b>11,49</b>
R <b>480291</b>	D3	63	40	65	57	150	5,8	3,7	0,130	50	<b>11,48</b>
<b>480292</b>	D3	63	50	65	63	150	5,8	4,6	0,130	50	<b>11,95</b>
R <b>480293</b>	D3	75	40	72	57	170	6,8	3,7	0,178	60	<b>16,89</b>
<b>480294</b>	D3	75	50	72	63	170	6,8	4,6	0,191	50	<b>16,78</b>
<b>480295</b>	D3	75	63	72	65	170	6,8	5,8	0,216	50	<b>16,76</b>
<b>480296</b>	D3	90	50	81	63	190	8,2	4,6	0,291	18	<b>23,23</b>
<b>480297</b>	D3	90	63	81	65	190	8,2	5,8	0,317	18	<b>23,48</b>
<b>480298</b>	D3	90	75	81	70	190	8,2	6,8	0,355	18	<b>23,38</b>
<b>480299</b>	D3	110	63	86	65	205	10,0	5,8	0,469	24	<b>30,67</b>
<b>480300</b>	D3	110	75	86	70	205	10,0	6,8	0,497	10	<b>30,67</b>
<b>480301</b>	D3	110	90	86	81	205	10,0	8,2	0,557	9	<b>30,67</b>
R <b>480323</b>	D3	125	63	87	63	200	11,4	5,8	0,579	15	<b>39,24</b>
R <b>480302</b>	D3	125	75	92	72	215	11,4	6,8	0,668	15	<b>38,49</b>
R <b>480303</b>	D3	125	90	92	81	215	11,4	8,2	0,673	15	<b>38,49</b>
<b>480304</b>	D3	125	110	92	86	215	11,4	10,0	0,786	15	<b>38,49</b>
R <b>480480</b>	D3	140	75	110	70	230	12,7	6,8	0,910	14	<b>59,90</b>
R <b>480481</b>	D3	140	90	110	79	230	12,7	8,2	0,954	14	<b>62,94</b>
R <b>480482</b>	D3	140	110	110	82	230	12,7	10,0	0,820	12	<b>61,57</b>
R <b>480278</b>	D3	140	125	110	90	235	12,7	11,4	0,988	12	<b>61,57</b>

R Contattare il Customer Service per tempistiche sulla disponibilità

\* Ad esaurimento



**Riduzioni (Tipo L) PE 100 PN 16 MOP 5 SDR 11 (continua)**

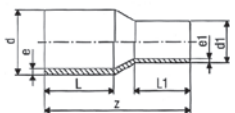

Code	Classe	d mm	d1 mm	L mm	L1 mm	z mm	e mm	e1 mm	peso kg	Conf.	Euro pz.
<b>R 480315</b>	D3	160	90	120	79	248	14,6	8,2	1,164	10	<b>72,25</b>
<b>480305</b>	D3	160	110	102	86	245	14,6	10,0	1,298	5	<b>72,25</b>
<b>480306</b>	D3	160	125	102	92	245	14,6	11,4	1,403	5	<b>72,25</b>
<b>R 480279</b>	D3	160	140	120	110	260	14,6	12,7	1,522	10	<b>73,58</b>
<b>R 480325</b>	D3	180	110	82	16,4	105	10,0	10,0	1,833	8	<b>85,76</b>
<b>R 480307</b>	D3	180	125	92	16,4	107	11,4	11,4	1,720	8	<b>78,47</b>
<b>R 480308</b>	D3	180	160	102	16,4	107	14,6	14,6	1,980	6	<b>89,19</b>
<b>R 480327</b>	D3	200	140	110	18,2	120	12,7	12,7	2,326	6	<b>113,04</b>
<b>480309</b>	D3	200	160	102	18,2	117	14,6	14,6	2,370	6	<b>103,55</b>
<b>R 480310</b>	D3	200	180	107	18,2	117	16,4	16,4	2,681	5	<b>104,23</b>
<b>R 480328</b>	D3	225	140	130	110	295	20,5	12,7	2,900	4	<b>170,22</b>
<b>* 480311</b>	D3	225	160	122	102	280	20,5	14,6	3,118	4	<b>176,07</b>
<b>R 480312</b>	D3	225	180	122	107	280	20,5	16,4	3,268	4	<b>175,70</b>
<b>R 480329</b>	D3	250	180	130	105	295	22,7	16,4	4,299	6	<b>318,77</b>
<b>R 480317</b>	D3	250	200	130	112	302	22,7	18,2	2,385	6	<b>287,68</b>
<b>R 480359</b>	D3	250	225	130	120	332	22,7	20,5	2,385	6	<b>304,50</b>
<b>R 480360</b>	D3	280	200	140	112	333	25,4	18,2	6,850	6	<b>407,19</b>
<b>480322</b>	D3	315	250	150	130	365	28,6	22,7	8,360	4	<b>495,60</b>

R Contattare il Customer Service per tempistiche sulla disponibilita

\* Ad esaurimento



**Fine Linea (Tipo L) PE 100 PN 16 MOP 5 SDR 11**

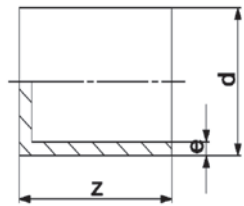

Codice	Classe	d mm	d1 mm	L mm	H mm	e mm	z mm	peso kg	Conf.	Euro pz.
R 480266	D3	75				6,8	80	0,15	40	<b>25,57</b>
480267	D3	90				8,2	90	0,238	50	<b>33,12</b>
480268	D3	110				10	98	0,376	30	<b>42,35</b>
480269	D3	125				11,4	105	0,523	12	<b>48,73</b>
480271	D3	160				14,6	120	1,035	8	<b>74,38</b>
R 480273	D3	200				18,2	138	1,839	5	<b>117,26</b>
R 480275	D3	250				22,7	205	3,927	4	<b>194,81</b>
R 480277	D3	315				28,6	255	6,861	2	<b>429,86</b>

**Cartella tipo LS PN 16 MOP 5 SDR 11**

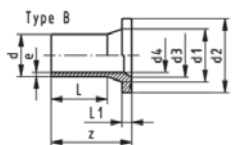
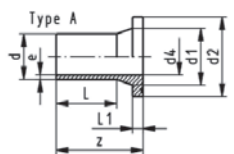
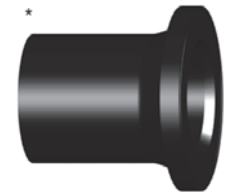
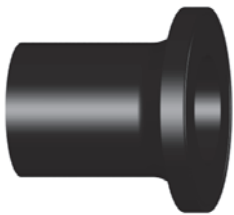

Codice	Classe	d mm	DN mm	d1 mm	d2 mm	d3 mm	d4 mm	L mm	L1 mm	L2 mm	e mm	Conf.	Euro pz.
R 485522	D3	32	25	40	68		26	85	44	10	3	25	<b>7,78</b>
R 485523	D3	40	32	50	78		32	85	49	11	4	60	<b>8,46</b>
R 485524	D3	50	40	61	88		40	98	62	12	5	50	<b>13,00</b>
485525	D3	63	50	75	102		51	98	69	14	6	70	<b>11,70</b>
485526	D3	75	65	89	122	66	61	125	89	16	7	30	<b>14,83</b>
485527	D3	90	80	105	138	78	73	140	103	17	8	24	<b>18,76</b>
** 485528	D3	110	100	125	158	100	90	160	117	18	10	16	<b>23,17</b>
** 485529	D3	125	100	132	158	114	102	170	125	25	11	16	<b>28,80</b>
** 485530	D3	140	125	155	188	127	114	200	147	25	13	6	<b>36,66</b>
** 485531	D3	160	150	175	212	158	130	200	147	25	15	6	<b>43,37</b>
R ** 485532	D3	180	150	180	212	158	147	200	170	30	16	6	<b>72,18</b>
** 485533	D3	200	200	232	268	203	163	200	128	32	18	4	<b>78,40</b>
R * 485534	D3	225	200	235	268	210	184	200	138	32	21	4	<b>93,06</b>
R ** 485535	D3	250	250	285	320	245	204	219	138	35	23	2	<b>173,02</b>
** 485557	D3	315	300	335	370	300	257	239	158	35	29	2	<b>300,43</b>

\*\*Type B con spigolo smussato

R Contattare il Customer Service per tempistiche sulla disponibilita

\* Ad esaurimento

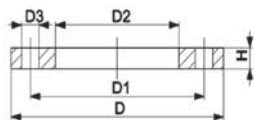

**Flangia libera in acciaio PN 16**

Codice	Classe	d mm	DN mm	D mm	D1 mm	D2 mm	D3 mm	H mm	Num. fori	Filetto	Conf.	Euro pz.
<b>R 905000</b>	W3	32	25	115	85	42	14	12	4	M12	1	<b>30,32</b>
<b>* 905001</b>	W3	40	32	140	100	51	18	16	4	M16	1	<b>32,78</b>
<b>R 905002</b>	W3	50	40	150	110	62	18	20	4	M16	1	<b>37,30</b>
<b>905003</b>	W3	63	50	165	125	78	18	20	4	M16	1	<b>49,41</b>
<b>905004</b>	W3	75	65	185	145	92	18	20	4	M16	1	<b>50,93</b>
<b>905005</b>	W3	90	80	200	160	108	18	20	8	M16	1	<b>52,22</b>
<b>905006</b>	W3	110	100	220	180	128	18	20	8	M16	1	<b>67,72</b>
<b>* 904397</b>	W3	125	100	220	180	135	18	20	8	M16	1	<b>45,24</b>
<b>905007</b>	W3	125	125	220	180	135	18	20	8	M16	1	<b>178,68</b>
<b>905008</b>	W3	140	125	250	210	158	18	24	8	M16	1	<b>116,35</b>
<b>905009</b>	W3	160	150	285	240	178	22	24	8	M20	1	<b>126,25</b>
<b>R 904398</b>	W3	180	150	285	240	188	22	20	8	M20	1	<b>78,32</b>
<b>R 904475</b>	W3	200	200	340	295	235	22	24	12	M20	1	<b>113,59</b>
<b>R 904477</b>	W3	250	250	405	355	288	26	30	12	M24	1	<b>202,68</b>
<b>R 905010</b>	W3	315	300	460	410	338	26	43	12	M24	1	<b>861,30</b>

R Contattare il Customer Service per tempistiche sulla disponibilita

\* Ad esaurimento



**Guarnizioni**

Codice	Classe	de mm	DN -	d1 mm	d2 mm	b mm	z mm	z1 mm	Conf.	Euro pz.
<b>NBR</b>										
R 904432	W3	32	25	70	28	3			10	3,41
R 904433	W3	40	32	82	36	3			10	3,41
R 904434	W3	50	40	92	45	3			10	4,55
R 904435	W3	63	50	107	56	3			10	3,59
R 904436	W3	75	65	127	67	3			10	5,50
904437	W3	90	80	142	84	3			10	6,64
904438	W3	110/125	100	162	103	3			10	5,96
R 904440	W3	160	150	218	150	3			10	28,67
R 904441	W3	200	200	273	200	4			10	22,43
<b>EPDM</b>										
R 904402	W3	32	25	70	28	3			10	3,71
R 904403	W3	40	32	82	36	3			10	4,05
R 904404	W3	50	40	92	45	3			10	3,80
904405	W3	63	50	107	56	3			10	4,70
904406	W3	75	65	127	67	3			10	5,08
904407	W3	90	80	142	84	3			10	6,47
904408	W3	110	100	162	103	3			10	7,29
R 904461	W3	140							10	11,42
904462	W3	160	150	218	150	3			10	11,42
R 904463	W3	200/225	200	273	200	4			10	22,43
309251	W1	315		378	320	4			10	43,59

- Gamma nitrilica (NBR): per gas
- Gamma sintetica (EPDM): per acqua

**Giunti filettati di transizione PE-AC PE 100 SDR 11 PN 16 MOP 5**



Codice	Classe	D2 mm	D1 -	L1 mm	L2 mm	S1 mm	S2 mm	z mm	Conf.	Euro pz.
900522	W3	25	3/4"	150	310	2,3	3,0		20	47,57
900523	W3	32	1"	150	310	2,6	3,0		20	50,44
900524	W3	40	1 1/4"	150	310	2,6	3,7		15	53,16
900525	W3	50	1 1/2"	150	310	2,9	4,6		10	59,60
900526	W3	63	2"	150	310	2,9	5,8		10	69,30
900527	W3	75	2 1/2"	200	310	3,2	6,8		5	187,41
900529	W3	90	3"	200	310	3,2	8,2		4	221,81
900530	W3	110	4"	200	310	3,6	10,0		1	339,54
900531	W3	125	4"	250	310	3,6	11,4		1	352,92
R * 900534	W3	140	5"	200	310		12,7		1	472,54
R ** 900536	W3	160	6"	200	310	5,0	14,6		1	600,97
R ** 900538	W3	180	6"	200	310		16,4		1	645,69

\*\*Dal Ø 140: tubo metallico senza filettatura, da saldare

R Contattare il Customer Service per tempistiche sulla disponibilita

\* Ad esaurimento





**Giunti curvi filettati di transizione PE-AC PE 100 SDR 11 PN 16 MOP 5**



Codice	Classe	D2 mm	D1 -	L1 mm	L2 mm	S1 mm	S2 mm	z mm	Conf.	Euro pz.
<b>900552</b>	W3	25	3/4"	550	150	600	3,0		1	<b>113,63</b>
<b>900553</b>	W3	32	1"	550	150	600	3,0		1	<b>127,38</b>
<b>900554</b>	W3	40	1 1/4"	550	150	600	3,7		1	<b>135,68</b>
<b>900555</b>	W3	50	1 1/2"	550	150	600	4,6		1	<b>163,84</b>
<b>R 900556</b>	W3	63	2"	550	150	600	5,8		1	<b>189,07</b>

**Giunti di transizione PE-ottone Filettato Maschio S5 SDR 11 PN 16**

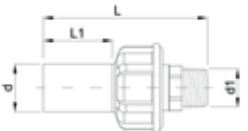

Codice	Classe	D mm	D1 -	L mm	L1 mm	peso kg	Conf.	Euro pz.
<b>R 902201</b>	W3	20	1/2"	82	38	0,115	10	<b>19,04</b>
<b>902202</b>	W3	25	3/4"	91	40	0,120	50	<b>21,92</b>
<b>902203</b>	W3	32	1"	100	44	0,178	30	<b>24,02</b>
<b>902204</b>	W3	40	1 1/4"	109	49	0,271	15	<b>37,65</b>
<b>902205</b>	W3	50	1 1/2"	124	54	0,365	10	<b>44,73</b>
<b>902206</b>	W3	63	2"	141	63	0,591	6	<b>60,61</b>
<b>902207</b>	W3	75	2 1/2"	163	73	0,891	15	<b>109,27</b>
<b>902208</b>	W3	90	3"	181	82	1,138	10	<b>163,46</b>
<b>R 902209</b>	W3	110	4"	190	84	1,856	6	<b>208,44</b>

**Giunti di transizione PE-ottone Filettato Femmina S5 SDR 11 PN 16**

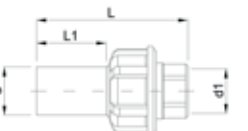

Codice	Classe	D mm	D1 -	L mm	L1 mm	peso kg	Conf.	Euro pz.
<b>R 902213</b>	W3	25	3/4"	91	40	0,145	50	<b>21,76</b>
<b>902214</b>	W3	32	1"	100	44	0,195	30	<b>22,98</b>
<b>R 902215</b>	W3	40	1 1/4"	109	49	0,320	15	<b>37,94</b>
<b>R 902216</b>	W3	50	1 1/2"	124	54	0,382	10	<b>44,13</b>
<b>902217</b>	W3	63	2"	141	63	0,598	6	<b>61,22</b>
<b>R 902218</b>	W3	75	2 1/2"	163	73	0,902	15	<b>105,95</b>
<b>R 902219</b>	W3	90	3"	181	82	1,150	10	<b>160,15</b>
<b>R 902220</b>	W3	110	4"	190	84	1,870	6	<b>226,28</b>

**Raccordi filettati PE 100 - Ghisa SRD 11 PN 16**



Codice	Classe	Dim.	L mm	H mm	S mm PE80 PN16	peso kg	Conf.	Euro pz.
<b>* 900572</b>	W3	25x3/4"	45	35	3,5	0,30	1	<b>29,13</b>
<b>R 900573</b>	W3	32x1"	50	40	4,5	0,35	1	<b>32,12</b>
<b>R 900574</b>	W3	40x1 1/4"	55	43	5,6	0,65	1	<b>41,52</b>
<b>R 900575</b>	W3	50x1 1/2"	55	45	6,9	0,75	1	<b>46,17</b>
<b>R 900576</b>	W3	63x2"	64	50	8,7	1,10	1	<b>57,56</b>

R Contattare il Customer Service per tempistiche sulla disponibilita

\* Ad esaurimento



**Saldatrice Polivalente WLW125R**

Codice	Classe	Alim. V	Sald. V	Frequ. Hz	Lungh. mm	Largh. mm	Altez. mm	peso kg	Conf.	Euro pz.
<b>574690</b>	X2	220-230	8-48	50-60	200	250	210	7	1	<b>2.960,64</b>

Completa di scanner, raschietto, connettori universali 4-4,7, borsa di trasporto.



**Saldatrice Polivalente WLW500**

Codice	Classe	Alim. V	Sald. V	Frequ. Hz	Lungh. mm	Largh. mm	Altez. mm	peso kg	Conf.	Euro pz.
<b>574710</b>	X2	220-230	8-48	50 - 60	255	270	385	18	1	<b>6.183,39</b>

Completa di scanner, raschietto, connettori universali 4-4,7, cassa di trasporto in alluminio



**Raschiatori**

Codice	Classe	Descrizione	Conf.	Euro pz.
<b>R 574010</b>	X2	Raschiatore PS 75/180	1	<b>1718,15</b>
<b>R 574011</b>	X2	Raschiatore RT 75/315	1	<b>3985,96</b>
<b>* 574001</b>	X2	Lama Ricambio per Raschiatore RT e PS	1	<b>169,87</b>

Cod. 574 010



Cod. 574 011

**Raschiatore manuale**

Codice	Classe	Conf.	Euro pz.
<b>579030</b>	X2	10	<b>24,28</b>

R Contattare il Customer Service per tempistiche sulla disponibilita

\* Ad esaurimento



### Posizionatore

Codice	Classe	de mm	Conf.	Euro pz.
R <b>574030</b>	X2	63 ÷ 160	1	<b>4.127,92</b>



### Detergente per PE

Codice	Classe	Quantità l	Conf.	Euro pz.
<b>400030</b>	W2	1	6	<b>25,87</b>

### Ricambi

Codice	Classe	Descrizione	Euro pz.
R <b>574017</b>	X2	Spinot. adat. 4,0 mm. sald. MSA (coppia)	<b>411,95</b>
R <b>574018</b>	X2	Spinot. adat. 4,7 mm. sald. MSA (coppia)	<b>437,79</b>
R <b>574631</b>	X2	Cavo arancio per saldatrice universale (574 680)	<b>580,85</b>

R Contattare il Customer Service per tempistiche sulla disponibilita



# Wavin Press Ring



## Informazioni

### MATERIALI

**Corpo, Anello di spinta:** Polipropilene copolimero (PP-B) ad alto grado di stabilità

**Calotta:** Polipropilene copolimero (PP-B) colorato con master ad alto grado di stabilità (Grado 8, ASTM D2565, 1-8)

**Anello di graffaggio:** Resina poliacetalica (POM)

**Guarnizione:** Gomma alimentare acrilonitrile (NBR e NBR speciale approvata KTW); durezza 70 sh

**Anello di rinforzo:** Su filettatura femmina da 1" 1/2 a 4" in acciaio INOX AISI 430

### COLORE

Anello di spinta e guarnizione: nero

Calotta: blu

Anello di graffaggio: bianco

### Standard

Per Tubi PE 80 – 100:

DIN 8072/8074 / UNI EN 12201 / UNI 7990

### Filettature di accoppiamento idraulico:

Filetto maschio

UNI-EN 10226-1

Filetto femmina

UNI-EN 10226-1

### Flange:

DIN 2501 / ISO 7005

Standards per prove di conformità raccordi:

ISO 3458-59/3501-3503-UNI9561 - UNI9562

DIN 8076 / UNI 403 / ISO14236.2

### Pressione nominale:

In linea generale i raccordi sono PN 16, eccetto alcune tipologie che rispondono alle seguenti pressioni nominali in base alle dimensioni:

de16-63 PN16

de75 110 PN10

Tali valori sono indicativi, vi invitiamo a consultare il singolo articolo per verificare l'esatta Pressione Nominale.

### TABELLA PRESSIONE DI ESERCIZIO AL VARIARE DELLA TEMPERATURA

PN a temperature tra -10°C +25°C	PN con temperature tra + 26° ÷ + 35°	PN con temperature tra + 36° ÷ + 45°
PFA* (PN) 16	PFA* (PN) 12,5	PFA* (PN) 10
PFA* (PN) 12,5	PFA* (PN) 10	PFA* (PN) 8
PFA* (PN) 10	PFA* (PN) 8	PFA* (PN) 6
PFA* (PN) 6	PFA* (PN) 4,5	N.A.

\* In accordo con la norma EN805

### PRESCRIZIONI SANITARIE

Raccordi idonei al convogliamento di acque potabili e di fluidi alimentari secondo le leggi e le prescrizioni vigenti in Italia (Decreto Ministeriale 6/4/2004 n° 174)

### CERTIFICAZIONI

Italia	IIP UNI 9561
Germania	DVGW N° DW8616 BT0204
Olanda	KIWA N° K12465
Svizzera	SVGW N° 0806-5360
Australia	WATERMARK WMKA N° 01762
Bulgaria	BULGARKONTROLA N° 14/24012008
Russia	GOST N° 0841495

### Componenti e specifiche

Una gamma completa di raccordi a compressione, che permette l'inserimento di tutti i tipi di tubo in polietilene (PE AD, PE BD, PE 80, PE 100) **senza smontare il raccordo**. È sufficiente allentare la calotta per poi inserire direttamente il tubo fino alla battuta (modello Push-fit).

- 1) Il corpo, in polipropilene nero, è stato progettato e costruito come una struttura unica nel design con rinforzi longitudinali. Ogni corpo presenta un'indicazione del lotto di produzione garantendo così una facile rintracciabilità.
- 2) L'anello di spinta, in polipropilene, svolge un'azione di bloccaggio della guarnizione a labbro, il cui limitato margine di mobilità determina, in fase di chiusura, l'ideale compressione della guarnizione sul tubo. L'anello di spinta è bloccato nel corpo al fine di evitarne la fuoriuscita qualora fosse necessario smontare il raccordo.
- 3) L'anello di graffaggio flottante, in resina acetilica, permette di compensare l'eventuale forza di trazione

causata dalla dilatazione lineare del tubo.

- 4) La calotta, in polipropilene blu, presenta una struttura caratterizzata da un'alta resistenza agli impatti. La calotta è altresì perfettamente resistente ai raggi UV.
- 5) La guarnizione a labbro offre il vantaggio, in fase di compressione, di garantire la perfetta adesione al tubo in PE coprendone un'estesa superficie e determinando così nel tempo una tenuta idraulica costante. La guarnizione a labbro determina un'elevata resistenza anche in condizioni di vuoti e/o aspirazione.



## Istruzioni di montaggio

### Ø 16 - 110 mm

Prima di procedere al montaggio verificare la presenza di tutti i componenti (guarnizione, anello di spinta, anello di graffaggio)

1. Tagliare il tubo sbavandolo (eventuale smussatura per semplificare il montaggio). Ungere la guarnizione se asciutta. Allentare la calotta senza rimuoverla dal corpo
2. Spingere la tubazione fino al primo arresto
3. Spingere ulteriormente fino al secondo arresto: il tubo è arrivato alla battuta del raccordo ed il montaggio è corretto
4. Avvitare la calotta serrandola a fondo. Fino al diametro d. 32 serraggio manuale o serraggio meccanico con chiave speciale od adeguate chiavi standard; a partire dal diametro d. 40 serraggio meccanico con chiave speciale od adeguate chiavi standard

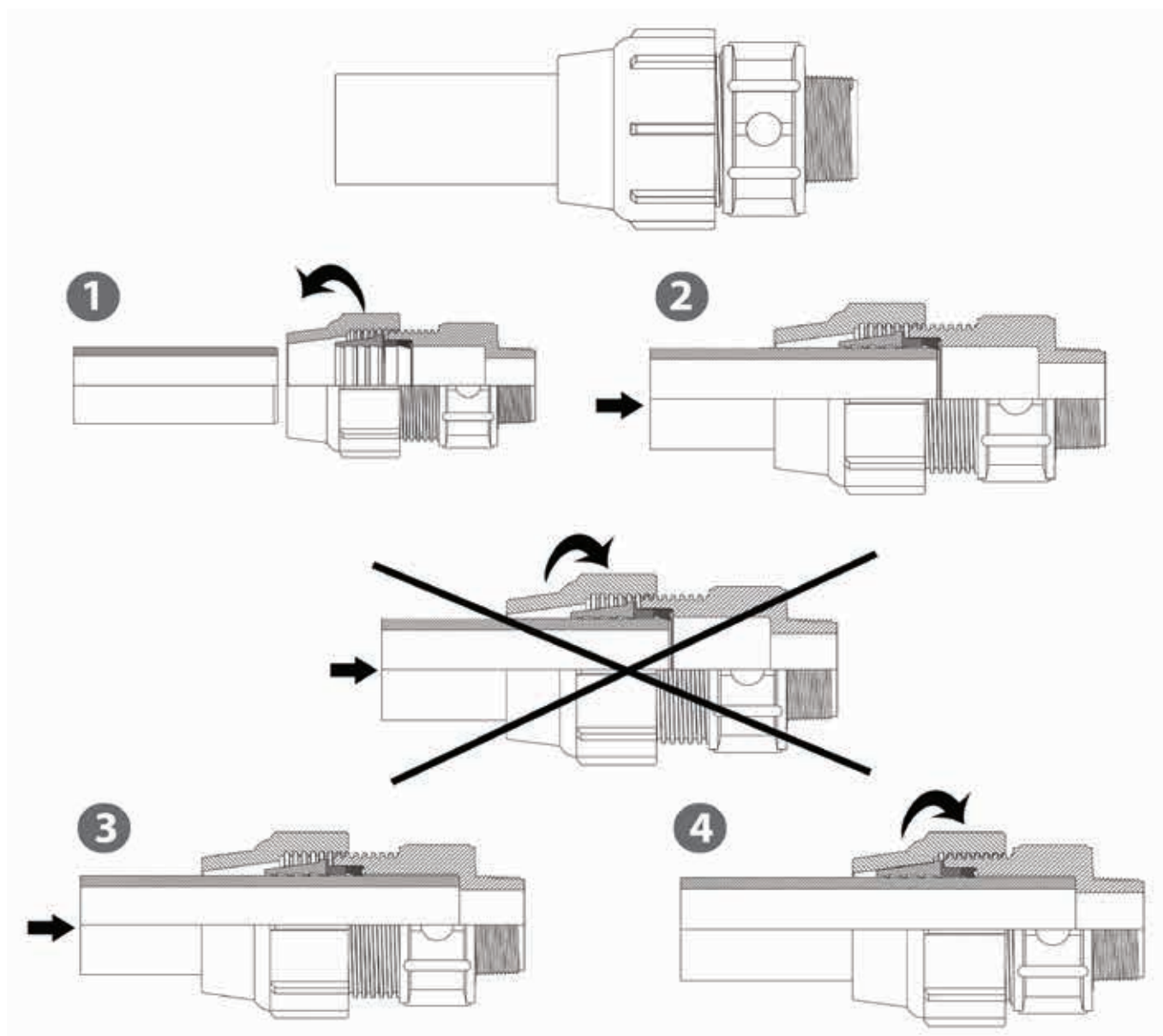

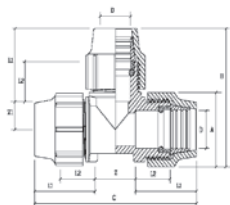

**T 90°**

Codice	Classe	d mm	PN mm	L1 mm	L2 mm	L3 mm	Z mm	Z1 mm	B mm	C mm	Conf.	Euro pz.
<b>491000A</b>	DB	16	16	48	30		30	14	76	126	30	<b>5,92</b>
<b>491001A</b>	DB	20	16	56	33		31	22	94	143	20	<b>6,04</b>
<b>491002A</b>	DB	25	16	57	35		37	23	99	151	10	<b>8,00</b>
<b>491003A</b>	DB	32	16	68	38		43	26	122	179	10	<b>10,27</b>
<b>491004A</b>	DB	40	16	79	42		51	35	156	209	20	<b>17,08</b>
<b>491005A</b>	DB	50	16	92	48		64	39	180	248	12	<b>22,67</b>
<b>491006A</b>	DB	63	16	108	58		82	42	200	300	8	<b>32,85</b>
<b>R 491007A</b>	DB	75	10	123	71		92	55	240	340	4	<b>56,39</b>
<b>R 491008A</b>	DB	90	10	160	93		107	65	270	430	1	<b>84,38</b>
<b>R 491009A</b>	DB	110	10	190	110		137	68	330	517	1	<b>157,86</b>

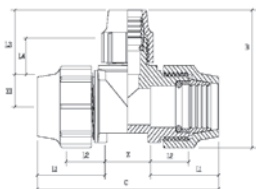

**T 90° ridotti**

Codice	Classe	d-d-d mm	PN mm	L1 mm	L2 mm	L3 mm	L4 mm	Z mm	Z1 mm	B mm	C mm	Conf.	Euro pz.
<b>491021A</b>	DB	25-20-25	16	56	35	55	34	38	20	101	150	10	<b>7,86</b>
<b>491032A</b>	DB	32-25-32	16	68	38	56	35	62	23	112	197	10	<b>10,20</b>
<b>* 491043A</b>	DB	40-32-40	16	81	42	72	41	80	32	139	241	21	<b>17,58</b>

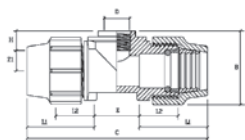

**T 90° filettati femmina**

Codice	Classe	d mm	D mm	PN mm	L1 mm	L2 mm	Z mm	Z1 mm	B mm	C mm	Conf.	Euro pz.
<b>493020A</b>	DB	16	1/2"	16	47	30	21	24	53	115	30	<b>4,70</b>
<b>493120A</b>	DB	20	1/2"	16	55	34	34	22	57	144	20	<b>5,08</b>
<b>493220A</b>	DB	25	1/2"	16	56	36	36	25	63	148	10	<b>6,64</b>
<b>493230A</b>	DB	25	3/4"	16	56	35	38	23	66	150	10	<b>6,64</b>
<b>493330A</b>	DB	32	3/4"	16	67	38	51	28	73	185	10	<b>8,35</b>
<b>493340A</b>	DB	32	1"	16	68	38	49	26	73	185	10	<b>8,35</b>
<b>R 493440A</b>	DB	40	1"	16	79	42	67	34	91	225	28	<b>16,32</b>
<b>493450A</b>	DB	40	1" 1/4	16	79	42	67	33	89	225	28	<b>15,78</b>
<b>493560A</b>	DB	50	1" 1/2	16	91	48	72	36	104	254	18	<b>21,40</b>
<b>493670A</b>	DB	63	2"	16	109	58	77	48	119	295	10	<b>30,74</b>
<b>R 493780A</b>	DB	75	2" 1/2	10	123	70	98	55	141	344	6	<b>53,16</b>
<b>R 493890A</b>	DB	90	3"	10	160	93	110	77	182	430	3	<b>93,80</b>
<b>493994A</b>	DB	110	4"	10	185	108	125	69	212	495	2	<b>120,99</b>

**R** Contattare il Customer Service per tempistiche sulla disponibilita

\* Ad esaurimento





**T 90° filettati maschio**

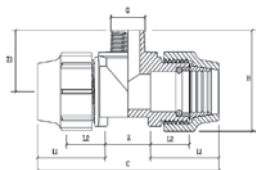

Codice	Classe	d mm	D mm	PN mm	L1 mm	L2 mm	Z mm	Z1 mm	B mm	C mm	Conf.	Euro pz.
<b>492120A</b>	DB	20	1/2"	16	55	33	34	23	58	144	20	<b>5,26</b>
<b>492230A</b>	DB	25	3/4"	16	55	35	39	23	64	149	10	<b>6,94</b>
<b>492340A</b>	DB	32	1"	16	67	38	51	27	73	185	10	<b>8,73</b>



**Raccordi filettati maschio**

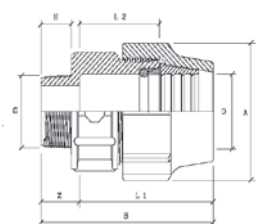

Codice	Classe	d mm	G mm	PN mm	L1 mm	L2 mm	Z mm	Z1 mm	B mm	H mm	Conf.	Euro pz.
<b>494020A</b>	DB	16	1/2"	16	32	35	19		74	16	30	<b>2,31</b>
<b>494120A</b>	DB	20	1/2"	16	58	40	19		79	15	20	<b>2,63</b>
<b>494130A</b>	DB	20	3/4"	16	58	40	21		81	16	20	<b>2,63</b>
<b>494220A</b>	DB	25	1/2"	16	61	40	19		80	15	10	<b>3,10</b>
<b>494230A</b>	DB	25	3/4"	16	61	40	20		81	17	10	<b>3,10</b>
<b>494240A</b>	DB	25	1"	16	61	40	24		84	20	10	<b>3,10</b>
<b>494330A</b>	DB	32	3/4"	16	70	43	24		95	20	10	<b>3,90</b>
<b>494340A</b>	DB	32	1"	16	70	43	24		95	20	10	<b>3,90</b>
<b>494350A</b>	DB	32	1" 1/4	16	70	43	24		99	23	10	<b>4,54</b>
<b>494440A</b>	DB	40	1"	16	83	49	27		109	20	60	<b>7,22</b>
<b>494450A</b>	DB	40	1" 1/4	16	83	49	29		111	23	60	<b>7,22</b>
<b>494460A</b>	DB	40	1" 1/2	16	83	49	31		111	23	55	<b>7,22</b>
<b>R 494550A</b>	DB	50	1" 1/4	16	95	51	35		126	23	35	<b>9,79</b>
<b>494560A</b>	DB	50	1" 1/2	16	95	51	37		127	23	35	<b>9,43</b>
<b>494570A</b>	DB	50	2"	16	95	51	41		133	28	35	<b>9,79</b>
<b>494670A</b>	DB	63	2"	16	115	74	36		160	28	24	<b>13,51</b>
<b>494780A</b>	DB	75	2" 1/2	16	130	85	40		184	30	15	<b>26,67</b>
<b>R 494870A</b>	DB	90	2"	16	155	86	38		206	28	8	<b>32,79</b>
<b>494890A</b>	DB	90	3"	16	155	86	44		212	34	8	<b>31,76</b>
<b>R 494990A</b>	DB	110	3"	16	185	109	49		234	34	6	<b>61,99</b>
<b>R 494994A</b>	DB	110	4"	16	185	111	52		238	39	6	<b>82,11</b>

R Contattare il Customer Service per tempistiche sulla disponibilita



**Raccordi filettati femmina**

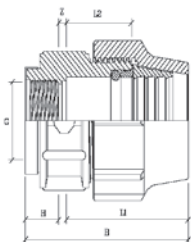

Codice	Classe	d mm	G mm	PN mm	L1 mm	L2 mm	Z mm	Z1 mm	B mm	H mm	Conf.	Euro pz.
<b>495020A</b>	DB	16	1/2"	16	46	13	8		68	16	30	<b>2,67</b>
<b>495120A</b>	DB	20	1/2"	16	51	13	8		74	16	20	<b>3,16</b>
<b>495130A</b>	DB	20	3/4"	16	51	13	8		74	16	20	<b>3,16</b>
<b>495220A</b>	DB	25	1/2"	16	52	15	10		77	19	10	<b>3,49</b>
<b>495230A</b>	DB	25	3/4"	16	52	15	10		77	19	10	<b>3,57</b>
<b>495240A</b>	DB	25	1"	16	52	15	10		77	19	10	<b>3,65</b>
<b>495330A</b>	DB	32	3/4"	16	64	15	8		91	19	10	<b>4,37</b>
<b>495340A</b>	DB	32	1"	16	64	15	8		91	19	10	<b>4,37</b>
<b>R 495440A</b>	DB	40	1"	16	75	16	8		104	21	60	<b>7,29</b>
<b>495450A</b>	DB	40	1 1/4"	16	75	16	8		104	21	60	<b>7,29</b>
<b>495560A</b>	DB	50	1 1/2"	16	57	17	39		124	28	35	<b>10,27</b>
<b>495670A</b>	DB	63	2"	16	64	18	54		144	26	24	<b>14,44</b>
<b>495780A</b>	DB	75	2 1/2"	10	78	24	46		154	30	15	<b>29,06</b>
<b>R 495890A</b>	DB	90	3"	10	94	34	79		205	32	8	<b>35,75</b>
<b>495994A</b>	DB	110	4"	10	111	41	89		238	38	6	<b>84,57</b>



**Manicotti**

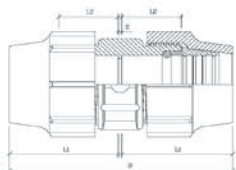

Codice	Classe	d mm	G mm	PN mm	L1 mm	L2 mm	Z mm	Z1 mm	B mm	Conf.	Euro pz.
<b>496200A</b>	DB	16		16	46	26	12		94	30	<b>3,41</b>
<b>496201A</b>	DB	20		16	51	29	12		106	20	<b>4,58</b>
<b>496202A</b>	DB	25		16	51	31	21		106	10	<b>5,61</b>
<b>496203A</b>	DB	32		16	65	34	21		131	10	<b>7,15</b>
<b>496204A</b>	DB	40		16	76	37	28		160	40	<b>11,57</b>
<b>496205A</b>	DB	50		16	93	50	34		193	25	<b>15,78</b>
<b>496206A</b>	DB	63		16	109	58	43		223	15	<b>21,84</b>
<b>496207A</b>	DB	75		16	120	69	49		250	8	<b>40,25</b>
<b>496208A</b>	DB	90		16	148	84	49		313	5	<b>50,36</b>
<b>R 496209A</b>	DB	110		16	170	93	66		358	3	<b>106,56</b>

R Contattare il Customer Service per tempistiche sulla disponibilita



**Manicotti di riparazione**

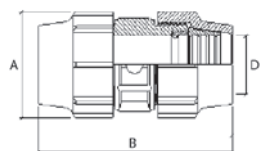

Codice	Classe	d mm	PN mm	L mm	L1 mm	L2 mm	Z mm	A mm	B mm	D mm	Conf.	Euro pz.
<b>496301A</b>	DB	20	16					48	121	21	20	<b>6,47</b>
<b>496302A</b>	DB	25	16					54	121	26	10	<b>7,65</b>
<b>496303A</b>	DB	32	16					65	142	33	10	<b>9,96</b>
<b>496304A</b>	DB	40	16					83	167	41	40	<b>16,05</b>
<b>496305A</b>	DB	50	16					96	185	51	25	<b>23,18</b>
<b>496306A</b>	DB	63	16					112	222	64	15	<b>32,12</b>
<b>R 496307A</b>	DB	75	16					135	258	76	8	<b>57,40</b>
<b>R 496308A</b>	DB	90	16					153	305	92	5	<b>69,63</b>
<b>496309A</b>	DB	110	16					179	359	112	3	<b>150,47</b>

**Manicotti ridotti**

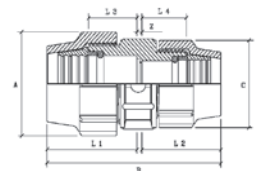

Codice	Classe	d-d mm	PN mm	L1 mm	L2 mm	L3 mm	L4 mm	Z mm	A mm	B mm	C mm	Conf.	Euro pz.
<b>496410A</b>	DB	20-16	16	52	29	45	26		47	100	39	20	<b>4,61</b>
<b>496421A</b>	DB	25-20	16	52	31	52	29	40	54	107	47	10	<b>4,96</b>
<b>496431A</b>	DB	32-20	16	73	43	59	38	19	65	135	47	10	<b>6,88</b>
<b>496432A</b>	DB	32-25	16	63	34	51	31	22	65	119	54	10	<b>6,64</b>
<b>496442A</b>	DB	40-25	16	76	38	52	32	16	83	130	53	45	<b>11,75</b>
<b>496443A</b>	DB	40-32	16	75	38	66	36	32	83	145	65	40	<b>11,42</b>
<b>R 496453A</b>	DB	50-32	16	93	51	75	46	31	96	175	65	30	<b>14,62</b>
<b>496454A</b>	DB	50-40	16	94	51	87	51	44	96	189	83	30	<b>14,62</b>
<b>496465A</b>	DB	63-50	16	122	71	69	39	21	114	214	96	15	<b>20,50</b>
<b>496476A</b>	DB	75-63	16	127	71	111	58	52	136	250	114	8	<b>37,13</b>
<b>R 496487A</b>	DB	90-75	16	154	85	111	57	46	158	285	136	6	<b>50,03</b>

**Fine linea**

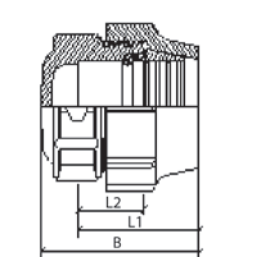

Codice	Classe	d mm	PN mm	L mm	L1 mm	L2 mm	Z mm	A mm	B mm	D mm	Conf.	Euro pz.
<b>496600A</b>	DB	16	16		32	13			54		30	<b>2,74</b>
<b>496601A</b>	DB	20	16		35	14			65		20	<b>3,41</b>
<b>496602A</b>	DB	25	16		33	15			66		10	<b>3,57</b>
<b>496603A</b>	DB	32	16		43	15			77		10	<b>4,17</b>
<b>496604A</b>	DB	40	16		49	16			91		60	<b>7,22</b>
<b>496605A</b>	DB	50	16		56	17			114		40	<b>10,62</b>
<b>496606A</b>	DB	63	16		65	18			134		24	<b>14,91</b>
<b>R 496607A</b>	DB	75	16		79	25			146		15	<b>38,36</b>

R Contattare il Customer Service per tempistiche sulla disponibilita

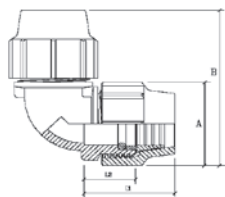

**Gomiti 90°**

Codice	Classe	d mm	PN mm	L mm	L1 mm	L2 mm	Z mm	A mm	B mm	D mm	Conf.	Euro pz.
<b>496800A</b>	DB	16	16		47	30		39	79		30	<b>3,57</b>
<b>496801A</b>	DB	20	16		56	34		47	96		20	<b>4,61</b>
<b>496802A</b>	DB	25	16		55	35		54	101		10	<b>5,61</b>
<b>496803A</b>	DB	32	16		67	38		65	121		10	<b>6,96</b>
<b>496804A</b>	DB	40	16		81	45		83	151		30	<b>12,13</b>
<b>496805A</b>	DB	50	16		92	49		96	175		20	<b>17,01</b>
<b>496806A</b>	DB	63	16		108	58		114	205		12	<b>20,64</b>
<b>496807A</b>	DB	75	16		128	72		136	240		6	<b>39,57</b>
<b>496808A</b>	DB	90	16		165	96		154	300		3	<b>48,58</b>
<b>R 496809A</b>	DB	110	16		185	108		175	330		2	<b>102,57</b>

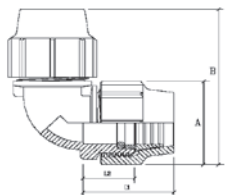

**Gomiti 90° filettati femmina**

Codice	Classe	d mm	G "	PN mm	L1 mm	L2 mm	Z mm	A mm	B mm	C mm	Conf.	Euro pz.
<b>497020A</b>	DB	16	1/2"	16	48	32	20	39	55	74	30	<b>2,92</b>
<b>497120A</b>	DB	20	1/2"	16	55	34	22	47	57	93	20	<b>3,49</b>
<b>497130A</b>	DB	20	3/4"	16	55	34	22	47	57	93	20	<b>3,49</b>
<b>497220A</b>	DB	25	1/2"	16	55	34	22	47	57	93	10	<b>4,24</b>
<b>497230A</b>	DB	25	3/4"	16	55	34	22	47	57	93	10	<b>4,24</b>
<b>R 497320A</b>	DB	32	1/2"	16	70	38	18	65	72	119	10	<b>5,16</b>
<b>497330A</b>	DB	32	3/4"	16	70	38	18	65	72	119	10	<b>5,16</b>
<b>497340A</b>	DB	32	1"	16	70	38	18	65	72	119	10	<b>5,16</b>
<b>R 497440A</b>	DB	40	1"	16	81	45	19	83	93	146	45	<b>10,97</b>
<b>497450A</b>	DB	40	1" 1/4	16	81	45	19	83	93	146	45	<b>10,97</b>
<b>497560A</b>	DB	50	1" 1/2	16	92	48	18	96	104	180	30	<b>14,62</b>
<b>R 497570A</b>	DB	50	2"	16	92	48	18	96	104	180	25	<b>14,58</b>
<b>497670A</b>	DB	63	2"	16	110	58	21	116	124	216	17	<b>19,71</b>
<b>497780A</b>	DB	75	2" 1/2	10	125	71	28	138	147	250	10	<b>37,16</b>
<b>R 497890A</b>	DB	90	3"	10	160	96	44	152	184	308	4	<b>64,20</b>

R Contattare il Customer Service per tempistiche sulla disponibilita



**Gomiti 90° filettati maschio**

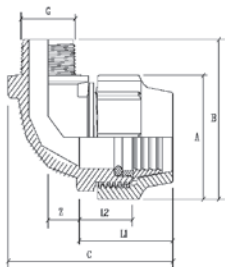

Codice	Classe	d mm	G "	PN mm	L1 mm	L2 mm	Z mm	A mm	B mm	C mm	Conf.	Euro pz.
<b>498020A</b>	DB	16	1/2"	16	50	30	20	40	53	75	30	<b>3,10</b>
<b>498120A</b>	DB	20	1/2"	16	56	34	22	47	63	94	20	<b>2,99</b>
<b>498130A</b>	DB	20	3/4"	16	56	34	22	47	63	94	20	<b>3,10</b>
<b>498230A</b>	DB	25	3/4"	16	56	35	19	53	74	99	10	<b>3,57</b>
<b>498340A</b>	DB	32	1"	16	69	38	18	65	86	120	10	<b>4,77</b>
<b>498450A</b>	DB	40	1" 1/4	16	81	45	19	83	103	147	45	<b>7,54</b>
<b>R 498460A</b>	DB	40	1" 1/2	16	81	45	19	83	103	147	40	<b>7,54</b>
<b>498560A</b>	DB	50	1" 1/2	16	92	50	21	96	118	186	30	<b>10,37</b>
<b>498670A</b>	DB	63	2"	16	109	58	22	113	138	215	17	<b>14,44</b>



**Raccordi flangiati**

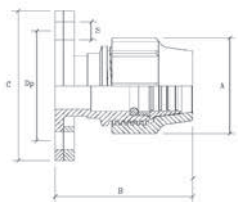

Codice	Classe	d mm	DN mm	PN mm	DP mm	S mm	Z mm	A mm	B mm	C mm	Conf.	Euro pz.
<b>R 496040A</b>	DB	75	2" 1/2	16	146	18		134	162	184	8	<b>102,75</b>
<b>R 496050A</b>	DB	90	3"	16	161	18		155	190	193	5	<b>140,66</b>

R Contattare il Customer Service per tempistiche sulla disponibilita



Prese a staffa con anello inox

Codice	Classe	d mm	Rp	PN	B	M	d1 mm	L mm	L1 mm	H mm	H1 mm	Conf.	Euro pz.
499410A	DB	25	1/2"	16	2	M8X30	13	49	79	58	15	1	3,65
499411A	DB	25	3/4"	16	2	M8X30	13	49	79	58	15	1	3,65
499415A	DB	32	1/2"	16	2	M8X30	14	49	79	62	20	1	4,17
499416A	DB	32	3/4"	16	2	M8X30	14	49	79	62	20	1	4,17
499420A	DB	40	1/2"	16	2	M8X40	21	62	86	71	20	1	4,46
499421A	DB	40	3/4"	16	2	M8X40	21	62	86	71	20	1	4,46
499422A	DB	40	1"	16	2	M8X40	21	62	86	70	19	1	4,54
499425A	DB	50	1/2"	16	4	M8X40	21	62	86	82	20	1	5,58
499426A	DB	50	3/4"	16	4	M8X40	21	62	86	82	20	1	4,87
499427A	DB	50	1"	16	4	M8X40	21	62	86	82	20	1	5,37
499431A	DB	63	3/4"	16	4	M8X40	24	62	101	96	21	1	6,17
499432A	DB	63	1"	16	4	M8X40	31	62	101	96	21	1	6,08
499434A	DB	63	1" 1/2"	16	4	M8X40	31	62	101	96	21	1	7,65
R 499442A	DB	75	1"	16	4	M8X60	27	79	123	107	19	1	7,94
499444A	DB	75	1" 1/2"	16	4	M8X60	42	79	123	109	21	1	10,45
R 499445A	DB	75	2"	16	4	M8X60	53	79	123	112	24	1	8,00
499451A	DB	90	3/4"	16	4	M8X60	21	87	138	118	16	1	8,74
R 499452A	DB	90	1"	16	4	M8X60	27	87	138	121	19	1	8,83
499454A	DB	90	1" 1/2"	16	4	M8X60	42	87	138	123	21	1	11,81
499455A	DB	90	2"	16	4	M8X60	53	87	138	126	24	1	9,02
R 499460A	DB	110	1/2"	16	6	M8X50	15	99	152	150	23	1	11,81
R 499461A	DB	110	3/4"	16	6	M8X50	20	99	152	150	23	1	11,51
* 499462A	DB	110	1"	16	6	M8X50	26	99	152	150	23	1	11,66
499464A	DB	110	1" 1/2"	16	6	M8X50	41	99	152	150	23	1	11,89
499465A	DB	110	2"	16	6	M8X50	51	99	152	150	23	1	11,89
R 499474A	DB	125	1" 1/2"	16	6	M8X50	41	101	166	168	23	1	24,37
499475A	DB	125	2"	16	6	M8X50	50	101	166	168	23	1	24,37
R 499495A	DB	160	2"	16	6	M8X70	51	114	226	215	24	1	39,90

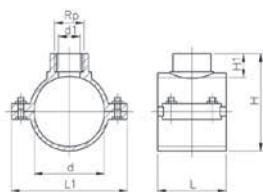

B= n°. di viti  
M= tipo di viti

R Contattare il Customer Service per tempistiche sulla disponibilita - \* Ad esaurimento

# Sanitherm NG



# Tubi



## Tubi multistrato in barre PE-Xc

Codice	Classe	Ø mm	Spess. Alu. mm	Imballo	Conf.	Euro m
<b>821416</b>	SA	16X2	0,4		125	<b>4,24</b>
<b>821420</b>	SA	20X2,5	0,4		90	<b>6,12</b>
<b>821426</b>	SA	26X3	0,5		50	<b>8,63</b>
<b>821432</b>	SA	32X3	0,7		35	<b>11,74</b>
<b>821440</b>	SA	40X3,5	0,7		20	<b>16,74</b>
<b>821450</b>	SA	50X4,5	0,7		10	<b>31,05</b>
<b>821463</b>	SA	63X6	0,6		15	<b>57,60</b>
** <b>821475</b>	SA	75X7,5	0,5		5	<b>92,74</b>

\*\* Prodotto in PE-RT



## Tubi multistrato nudo in rotoli PE-Xc

Codice	Classe	Ø mm	Spess. Alu. mm	Imballo	Conf.	Euro m
<b>801416</b>	SA	16X2	0,4	2200	100	<b>3,60</b>
<b>801420</b>	SA	20X2,5	0,4	1300	100	<b>5,46</b>
<b>801426</b>	SA	26X3	0,5	750	50	<b>7,77</b>
<b>801432</b>	SA	32X3	0,7	750	50	<b>10,95</b>



## Tubi multistrato preisolati in rotoli per uso sanitario/riscaldamento PE-Xc

Codice	Classe	Ø mm	Spess. isol. mm	Spess. Alu. mm	Imballo	Conf.	Euro m
<b>811416</b>	SA	16X2	6	0,4	750	50	<b>4,62</b>
<b>811420</b>	SA	20X2,5	6	0,4	600	50	<b>7,48</b>
<b>811320</b>	SA	20X2,5	9	0,4	500	50	<b>7,82</b>
<b>811426</b>	SA	26X3	9	0,5	275	25	<b>11,74</b>
<b>811432</b>	SA	32X3	9	0,7	225	25	<b>15,34</b>





### Tubo multistrato in rotoli in PE-Xc per uso riscaldamento

Codice	Classe	Ø mm	Spess. isol. mm	Spess. Alu. mm	Imballo	Conf.	Euro m
<b>811516</b>	SA	16X2	6	0,2	750	50	<b>3,89</b>



### Tubi multistrato preisolati in rotoli per uso condizionamento PE-Xc

Codice	Classe	Ø mm	Spess. isol. mm	Spess. Alu. mm	Imballo	Conf.	Euro m
<b>817020</b>	SA	20x2,5	9	0,4	350	25	<b>7,80</b>
<b>817026</b>	SA	26x3	13	0,5	275	25	<b>12,37</b>

## Raccordi a pressare



### Manicotti NG

Codice	Classe	Ø mm	Imballo	Conf.	Euro pz
<b>850010</b>	SB	16X16	60	10	<b>10,80</b>
<b>850012</b>	SB	20X20	60	10	<b>11,52</b>
<b>850013</b>	SB	26X26	30	5	<b>20,70</b>
<b>850014</b>	SB	32X32	30	5	<b>28,77</b>
<b>850015</b>	SB	40X40	20	5	<b>58,99</b>
<b>890005</b>	SB	50X50	18	3	<b>77,78</b>
<b>890063</b>	SB	63X63	8	2	<b>127,64</b>
<b>R 890075</b>	SB	75X75	4	2	<b>179,89</b>



### Manicotti ridotti NG

Codice	Classe	Ø mm	Imballo	Conf.	Euro pz
<b>850021</b>	SB	20x16	60	10	<b>11,13</b>
<b>850025</b>	SB	26x16	30	5	<b>18,94</b>
<b>850023</b>	SB	26x20	30	5	<b>17,36</b>
<b>850027</b>	SB	32x20	30	5	<b>26,64</b>
<b>850026</b>	SB	32x26	30	5	<b>28,04</b>
<b>850030</b>	SB	40x26	30	5	<b>54,22</b>
<b>850029</b>	SB	40x32	30	5	<b>54,90</b>
<b>890025</b>	SB	50x40NG	12	3	<b>77,78</b>
<b>R 890026</b>	SB	63x50	8	2	<b>134,02</b>
<b>R 890028</b>	SB	75x63	4	2	<b>164,95</b>



R Contattare il Customer Service per tempistiche sulla disponibilità



### Manicotti filettati femmina NG

Codice	Classe	Ø mm	Imballo	Conf.	Euro pz
<b>850050</b>	SB	16x1/2"	60	10	<b>9,21</b>
<b>850052</b>	SB	20x1/2"	60	10	<b>9,58</b>
<b>850054</b>	SB	20x3/4"	60	10	<b>13,41</b>
<b>850055</b>	SB	26x3/4"	30	5	<b>17,61</b>
<b>850056</b>	SB	26x1"	30	5	<b>21,85</b>
<b>850057</b>	SB	32x1"	30	5	<b>27,58</b>
<b>850058</b>	SB	40x1"1/4"	20	5	<b>61,82</b>
<b>890055</b>	SB	50x1"1/2	18	3	<b>63,76</b>
<b>890056</b>	SB	63x2"	6	2	<b>109,55</b>



### Manicotto con girella filettato femmina NG

Codice	Classe	Ø mm	Imballo	Conf.	Euro pz
<b>850082</b>	SB	20x3/4"	60	10	<b>19,72</b>
<b>850083</b>	SB	26x1"	30	5	<b>31,23</b>

R Contattare il Customer Service per tempistiche sulla disponibilità



### Manicotti filettati maschio NG

Codice	Classe	Ø mm	Imballo	Conf.	Euro pz
<b>850060</b>	SB	16x1/2"	60	10	<b>9,31</b>
<b>850062</b>	SB	20x1/2"	60	10	<b>8,64</b>
<b>850064</b>	SB	20x3/4"	60	10	<b>12,18</b>
<b>850065</b>	SB	26x3/4"	30	5	<b>15,09</b>
<b>850066</b>	SB	26x1"	30	5	<b>21,18</b>
<b>850067</b>	SB	32x1"	30	5	<b>22,85</b>
<b>850068</b>	SB	40x1"1/4	20	5	<b>43,12</b>
<b>890065</b>	SB	50x1"1/2	12	3	<b>61,85</b>
<b>890066</b>	SB	63x2"	4	2	<b>114,44</b>
<b>R 890067</b>	SB	75x2"1/2	4	2	<b>155,31</b>



### Gomiti 45°

Codice	Classe	Ø mm	Imballo	Conf.	Euro pz
<b>R 890305</b>	SB	50x50	6	3	<b>112,79</b>
<b>R 890306</b>	SB	63x63	4	2	<b>209,24</b>
<b>* R 890307</b>	SB	75x75	2	1	<b>237,00</b>



### Gomiti 90° NG

Codice	Classe	Ø mm	Imballo	Conf.	Euro pz
<b>850110</b>	SB	16x16	60	10	<b>13,70</b>
<b>850112</b>	SB	20x20	60	10	<b>14,48</b>
<b>850113</b>	SB	26x26	30	5	<b>24,53</b>
<b>850114</b>	SB	32x32	30	5	<b>36,94</b>
<b>850115</b>	SB	40x40	16	4	<b>77,53</b>
<b>890105</b>	SB	50x50	6	3	<b>88,26</b>
<b>890106</b>	SB	63x63	4	2	<b>194,44</b>
<b>R 890107</b>	SB	75x75	2	1	<b>286,03</b>



R Contattare il Customer Service per tempistiche sulla disponibilità - \* Ad esaurimento



### Gomiti filettati femmina NG

Codice	Classe	Ø mm	Imballo	Conf.	Euro pz
<b>850120</b>	SB	16x1/2"	60	10	<b>10,54</b>
<b>850122</b>	SB	20x1/2"	60	10	<b>11,75</b>
<b>850124</b>	SB	20x3/4"	60	10	<b>18,72</b>
<b>850125</b>	SB	26x3/4"	30	5	<b>23,25</b>
<b>850127</b>	SB	32x1"	30	5	<b>37,37</b>
<b>850128</b>	SB	40x1"1/4	20	5	<b>58,57</b>
<b>R 890125</b>	SB	50x1"1/2	6	3	<b>81,52</b>
<b>R 890126</b>	SB	63x2"	4	2	<b>185,58</b>
<b>* R 890127</b>	SB	75x2"1/2	2	1	<b>318,81</b>



### Gomiti filettati maschi NG

Codice	Classe	Ø mm	Imballo	Conf.	Euro pz
<b>850130</b>	SB	16x1/2"	60	10	<b>11,19</b>
<b>850132</b>	SB	20x1/2"	60	10	<b>11,56</b>
<b>850134</b>	SB	20x3/4"	60	10	<b>18,72</b>
<b>850135</b>	SB	26x3/4"	30	5	<b>23,13</b>
<b>850137</b>	SB	32x1"	30	5	<b>30,63</b>
<b>850138</b>	SB	40x1"1/4	20	5	<b>58,57</b>
<b>R 890135</b>	SB	50x1"1/2	6	3	<b>122,63</b>
<b>R 890136</b>	SB	63x2"	4	2	<b>205,93</b>
<b>* R 890137</b>	SB	75x2"1/2	2	1	<b>318,81</b>



R Contattare il Customer Service per tempistiche sulla disponibilità - \* Ad esaurimento



## Tee NG

Codice	Classe	Ø mm	Imballo	Conf.	Euro pz
<b>850210</b>	SB	16x16x16	60	10	<b>15,81</b>
<b>850212</b>	SB	20x20x20	60	10	<b>18,88</b>
<b>850213</b>	SB	26x26x 26	30	5	<b>32,57</b>
<b>850214</b>	SB	32x32x 32	20	5	<b>42,14</b>
<b>850215</b>	SB	40x40x40	8	2	<b>107,71</b>
<b>890215</b>	SB	50x50x50	4	2	<b>124,26</b>
R <b>890216</b>	SB	63x63x63	2	1	<b>256,56</b>
* R <b>890218</b>	SB	75x75x75	2	1	<b>302,42</b>



## Tee ridotti NG

Codice	Classe	Ø mm	Imballo	Conf.	Euro pz
<b>850225</b>	SB	16x20x16	60	10	<b>19,14</b>
<b>850224</b>	SB	20x16x16	60	10	<b>19,14</b>
<b>850223</b>	SB	20x16x20	60	10	<b>19,53</b>
<b>850226</b>	SB	20x20x16	60	10	<b>19,53</b>
<b>850235</b>	SB	26x16x26	30	5	<b>32,66</b>
<b>850228</b>	SB	26x20x20	30	5	<b>31,62</b>
<b>850227</b>	SB	26x20x26	30	5	<b>33,01</b>
<b>850230</b>	SB	26x26x20	30	5	<b>33,01</b>
<b>850243</b>	SB	32x20x32	20	5	<b>42,63</b>
<b>850240</b>	SB	32x26x26	20	5	<b>51,36</b>
<b>850239</b>	SB	32x26x32	20	5	<b>51,36</b>
<b>850284</b>	SB	40x26x40	8	2	<b>108,20</b>
<b>850280</b>	SB	40x32x40	8	2	<b>111,36</b>
<b>890225</b>	SB	50x40NGx50	4	1	<b>140,24</b>
* R <b>890217</b>	SB	63x50x63	4	2	<b>230,65</b>
* R <b>890222</b>	SB	75x50x75	2	1	<b>333,49</b>
* R <b>890223</b>	SB	75x63x75	2	1	<b>392,17</b>



R Contattare il Customer Service per tempistiche sulla disponibilità - \* Ad esaurimento



### Tee filettati femmina NG

Codice	Classe	Ø mm	Imballo	Conf.	Euro pz
<b>850250</b>	SB	16x1/2"x16	60	10	<b>16,70</b>
<b>850252</b>	SB	20x1/2"x20	60	10	<b>17,45</b>
<b>850255</b>	SB	26x 3/4"x26	30	5	<b>29,90</b>
<b>850257</b>	SB	32x1"x32	20	5	<b>39,46</b>
<b>850259</b>	SB	40x1"1/4x40	12	3	<b>79,48</b>
<b>890255</b>	SB	50x1"x50	6	3	<b>109,55</b>
* R <b>890235</b>	SB	50x1"1/2x50	4	2	<b>160,20</b>
<b>890256</b>	SB	63x2"x63	3	1	<b>277,84</b>
* R <b>890257</b>	SB	75x2"1/2x75	2	1	<b>416,88</b>



### Terminali con staffa NG

Codice	Classe	Ø mm	Imballo	Conf.	Euro pz
<b>850505</b>	SB	16x1/2" FF	60	10	<b>15,29</b>
<b>850507</b>	SB	20x1/2" FF	60	10	<b>17,36</b>



### Terminali NG

Codice	Classe	Ø mm	Imballo	Conf.	Euro pz
<b>850510</b>	SB	16 x 1/2" FF	60	10	<b>15,13</b>
<b>850512</b>	SB	20 x 1/2" FF	60	10	<b>17,36</b>

R Contattare il Customer Service per tempistiche sulla disponibilità - \* Ad esaurimento



### Terminali doppi a 15° NG

Codice	Classe	Ø mm		Imballo	Conf.	Euro pz
<b>850530</b>	SB	16x1/2"x16 FF		60	10	<b>30,50</b>
<b>850532</b>	SB	20x1/2"x20 FF		60	10	<b>31,09</b>



### Allacciamento radiatore NG

Codice	Classe	Ø mm	Materiale	L	Imballo	Conf.	Euro pz
<b>850910</b>	SB	16xØ14	Rame cromato	250	60	10	<b>26,37</b>



### Valvola da incasso

Codice	Classe	Ø mm		Imballo	Conf.	Euro pz
<b>850800</b>	SB	16x16		2	2	<b>57,45</b>
<b>850802</b>	SB	20x20		2	2	<b>57,45</b>
<b>850806</b>	SB	26x26		2	2	<b>71,17</b>

### Ricambi

Codice	Classe	Descrizione	Imballo	Conf.	Euro pz
<b>R 850807</b>	SC	Rosetta e cappuccio per valvole da incasso		1	<b>20,77</b>

Codice	Classe	Ø mm	Descrizione	Imballo	Conf.	Euro pz
<b>R 850808</b>	SC	16-18-20	Vitone 1/2" per valvole da incasso		1	<b>23,42</b>

**R** Contattare il Customer Service per tempistiche sulla disponibilità



**Kit manopola**

Codice	Classe	Imballo	Conf.	Euro pz
<b>R 850803</b>	SC	2	2	<b>23,47</b>

**Kit leva**

Codice	Classe	Imballo	Conf.	Euro pz
<b>R 850804</b>	SC	2	2	<b>23,47</b>

**Kit prolunga**

Codice	Classe	Imballo	Conf.	Euro pz
<b>850805</b>	SC	2	2	<b>4,94</b>

**Collettore con rubinetti orizzontali**

Codice	Classe	Misure mm	N° vie	Attacchi	A mm	Imballo	Conf.	Euro pz
<b>881312</b>	SB	3/4"	2	1/2	89		3	<b>32,70</b>
<b>881313</b>	SB	3/4"	3	1/2	127		3	<b>44,97</b>
<b>881314</b>	SB	3/4"	4	1/2	165		3	<b>58,00</b>
<b>881412</b>	SB	3/4"	2	3/4	113		3	<b>44,88</b>

**Collettore lineare**

Codice	Classe	Misure mm	N° vie	Attacchi	A mm	Imballo	Conf.	Euro pz
<b>881002</b>	SB	3/4"	2	1/2	90		5	<b>17,63</b>
<b>881003</b>	SB	3/4"	3	1/2	130		5	<b>24,20</b>
<b>881004</b>	SB	3/4"	4	1/2	170		5	<b>30,06</b>

R Contattare il Customer Service per tempistiche sulla disponibilità



### Tappo per collettore

Codice	Classe	Ø mm	Imballo	Conf.	Euro pz
<b>881034</b>	SB	3/4" FF	160	10	<b>4,41</b>
<b>881134</b>	SB	3/4"FM	160	10	<b>4,91</b>



### Adattatore collettore a pressare con girella NG

Codice	Classe	Ø mm	Imballo	Conf.	Euro pz
<b>850090</b>	SB	16x1/2"	60	10	<b>16,76</b>



### Adattatore per collettore

Codice	Classe	Ø mm	Imballo	Conf.	Euro pz
<b>880011</b>	SB	14X1/2"	60	10	<b>6,03</b>
<b>880012</b>	SB	16X1/2"	120	20	<b>6,18</b>
<b>880014</b>	SB	20X3/4"	60	10	<b>8,65</b>



### Cassette per collettori

Codice	Classe	A mm	B mm	H mm	Imballo	Conf.	Euro pz
<b>881330</b>	SC	300	250	95	55	11	<b>32,29</b>
<b>881340</b>	SC	400	250	95	40	8	<b>36,08</b>
<b>881348</b>	SC	480	250	95	35	7	<b>41,82</b>
<b>881360</b>	SC	600	250	95	25	5	<b>53,18</b>

### Staffe per collettori



Codice	Classe	Ø mm	Descrizione	Imballo	Conf.	Euro pz
<b>881301</b>	SC	3/4"	Staffa fissaggio differenziato collettore lineare Sanitherm NG		1	<b>5,88</b>
<b>R 881302</b>	SC	3/4"	Staffa fissaggio collettore complanare		1	<b>3,90</b>

R Contattare il Customer Service per tempistiche sulla disponibilità



### Ricambi per cassette

Codice	Classe	Descrizione	A mm	B mm	H mm	Imballo	Conf.	Euro pz
R <b>881330C</b>	SC	Coperchio	300	250	95		1	<b>16,00</b>
R <b>881340C</b>	SC	Coperchio	400	250	95		1	<b>24,03</b>
R <b>881348C</b>	SC	Coperchio	480	250	95		1	<b>27,22</b>
R <b>881360C</b>	SC	Coperchio	600	250	95		1	<b>40,85</b>



### Nipple svasato per giunzione tubo-tubo

Codice	Classe	Ø mm	Battuta	Imballo	Conf.	Euro pz
<b>880112</b>	SB	1/2"x1/2"	Svasata/Svasata	160	10	<b>3,82</b>
<b>880113</b>	SB	3/4"x3/4"	Svasata/Svasata	160	10	<b>4,63</b>
<b>880114</b>	SB	3/4"x1/2"	Svasata/Svasata	160	10	<b>5,46</b>



### Nipple femmina

Codice	Classe	Ø mm	Battuta	Imballo	Conf.	Euro pz
<b>880314</b>	SB	3/4"x1/2" F	Svasata	160	10	<b>6,46</b>

R Contattare il Customer Service per tempistiche sulla disponibilità

**Dima 75/155**

Codice	Classe	Interasse mm	Imballo	Conf.	Euro pz
<b>880842</b>	SC	75/155		10	<b>4,39</b>

**Dima sagomata ad incasso 75/155**

Codice	Classe	Interasse mm	Imballo	Conf.	Euro pz
<b>880852</b>	SC	75/155		10	<b>10,22</b>

**Tappi prova impianti**

Codice	Classe	Ø	Imballo	Conf.	Euro pz
<b>R 880720</b>	SC	1/2" Rosso		100	<b>1,52</b>
<b>R 880721</b>	SC	1/2" Blu		100	<b>1,52</b>
<b>R 880722</b>	SC	3/4" Rosso		100	<b>4,05</b>
<b>R 880723</b>	SC	3/4" Blu		100	<b>4,05</b>

**R** Contattare il Customer Service per tempistiche sulla disponibilità

## Attrezzature



### Pressatrice Mini ACO103 BT

Codice	Classe	Batteria	Tensione	Imballo	Conf.	Euro
			V			pz
<b>860081</b>	SFA	Sì	12		<b>1</b>	<b>3.152,69</b>

Contenuto confezione: pressatrice, batteria e caricabatteria  
Tecnologia Bluetooth per trasferimento dati e controllo prestazioni con l'applicazione "NovoCheck"

## Ricambi



### Batteria ricambio

Codice	Classe	Tensione	Imballo	Conf.	Euro
		V			pz
<b>R 860088</b>	SFA	230/3,0 Ah		<b>1</b>	<b>491,00</b>



### Ganasce per Pressatrice a batteria MINI ACO con profilo CH

Codice	Classe	Ø	Imballo	Conf.	Euro
		mm			pz
<b>R 861116</b>	SFA	16		<b>1</b>	<b>337,29</b>
<b>R 861120</b>	SFA	20		<b>1</b>	<b>337,29</b>
<b>R 861126</b>	SFA	26		<b>1</b>	<b>337,29</b>
<b>861132</b>	SFA	32		<b>1</b>	<b>337,29</b>



### Pressatrice 220V ECO203

Codice	Classe	Assorbimento	Completa di	Tensione	Imballo	Conf.	Euro
		W	valigetta in plastica	V			pz
<b>R 860230</b>	SFA	450	Sì	230		<b>1</b>	<b>3.513,43</b>

R Contattare il Customer Service per tempistiche sulla disponibilità



### Pressatrice 18V ACO203

Codice	Classe	Assorbimento W	Completa di valigetta in plastica	Tensione V	Imballo	Conf.	Euro pz
<b>860018</b>	SFA	400	Si	18		1	<b>3.934,90</b>

Contenuto confezione: pressatrice, batteria e caricabatteria

## Ricambi



### Batteria ricambio

Codice	Classe	Tensione V	Imballo	Conf.	Euro pz
<b>R 860019</b>	SFA	18/3Ah		1	<b>971,11</b>



### Carica batteria

Codice	Classe	Tensione V	Imballo	Conf.	Euro pz
<b>R 860089</b>	SFA	230/18		1	<b>345,27</b>



### Ganasce per pressatrici ECO e ACO con profilo CH

Codice	Classe	Ø mm	Mod.	Imballo	Conf.	Euro pz
<b>860216</b>	SFA	16	PB2		1	<b>422,54</b>
<b>860220</b>	SFA	20	PB2		1	<b>422,54</b>
<b>860226</b>	SFA	26	PB2		1	<b>422,54</b>
<b>860232</b>	SFA	32	PB2		1	<b>422,54</b>
<b>860440</b>	SFA	40	PB2		1	<b>422,54</b>



### Ganasce per pressatrici ECO e ACO con profilo U

Codice	Classe	Ø mm	Mod.	Imballo	Conf.	Euro pz
<b>R 860250</b>	SFA	50			1	<b>441,83</b>
<b>R 860263</b>	SFA	63			1	<b>748,40</b>

**R** Contattare il Customer Service per tempistiche sulla disponibilità \* Ad esaurimento



### Collare ACO202 75

Codice	Classe	Ø mm	Imballo	Conf.	Euro pz
R <b>860275</b>	SFA	75		1	<b>761,98</b>



### Adattatore per collare75

Codice	Classe	Ø mm	Imballo	Conf.	Euro pz
R <b>860100</b>	SFA	75		1	<b>719,60</b>



### Calibratore Kalimaus

Codice	Classe	Ø mm	Imballo	Conf.	Euro pz
R <b>897110</b>	SFA	16-18-20-26-32		1	<b>92,03</b>



### Set calibratore Kalispeed

Codice	Classe	Ø mm	Imballo	Conf.	Euro pz
<b>897200</b>	SFA	16-20-26-32		1	<b>306,94</b>



### Impugnatura Kalispeed

Codice	Classe	Ø mm	Imballo	Conf.	Euro pz
<b>897101</b>	SFA	14-32		1	<b>53,71</b>



### Impugnatura click-grip Kalispeed

Codice	Classe	Ø mm	Imballo	Conf.	Euro pz
R <b>897100</b>	SFA	14-75		1	<b>70,57</b>

R Contattare il Customer Service per tempistiche sulla disponibilità



### Calibratori per Kalispeed ed Ø 14-32

Codice	Classe	Ø mm	Imballo	Conf.	Euro pz
R 897214	SFA	14x2		1	<b>61,35</b>
897216	SFA	16x2		1	<b>61,35</b>
897220	SFA	20x2.5		1	<b>67,51</b>
897226	SFA	26x3		1	<b>70,57</b>
897232	SFA	32x3		1	<b>74,43</b>



### Calibratori per Kalispeed ed Ø 40-75

Codice	Classe	Ø mm	Imballo	Conf.	Euro pz
R 897240	SFA	40x3.5		1	<b>110,92</b>
R 897250	SFA	50x4.5		1	<b>116,58</b>
R 897263	SFA	63x6		1	<b>156,56</b>
R 897275	SFA	75x7.5		1	<b>202,87</b>



### Cesoia con fermatubo ferma tubo

Codice	Classe	Ø mm	Imballo	Conf.	Euro pz
R 850200	SFA	14-26		1	<b>152,04</b>
R 850201	SFA	Lama di ricambio per cesoia con ferma tubo 14-26		1	<b>20,31</b>



### Tagliatubo a rotella

Codice	Classe	Ø mm	Imballo	Conf.	Euro pz
R 850002	SFA	14-75		1	<b>120,85</b>

### Lama ricambio

Codice	Classe	Ø mm	Imballo	Conf.	Euro pz
R 850003	SFA	14-75	Per Tagliatubo cod. 85 00 02	1	<b>14,39</b>
R 850001	SFA	14-63	Per Tagliatubo cod. 85 00 00 non più a Listino	1	<b>43,64</b>

R Contattare il Customer Service per tempistiche sulla disponibilità





### Molla curvatubo

Codice	Classe	Misure mm	Minimo Imballo d'ordine	Conf.	Euro pz
<b>840016</b>	SFA	16x2		1	<b>12,74</b>
* <b>840018</b>	SFA	18x2		1	<b>12,74</b>
<b>840020</b>	SFA	20x2,5		1	<b>12,74</b>
<b>840026</b>	SFA	26x3		1	<b>16,14</b>

\* Ad esaurimento



# Hep<sub>2</sub>O





**Tubo in PB Barrier in barra**

Codice	D	d	A	B	Conf. Euro mt.
<b>AF510B</b>	15	11	4 mt	1,85	80 <b>3,14</b>
<b>AF511B</b>	22	18	4 mt	2,15	80 <b>5,91</b>
<b>AF512B</b>	28	22	4 mt	2,75	48 <b>11,10</b>



**Tubo nudo in PB Barrier in rotolo**

Codice	D	d	A	B	Pallet	Conf. Euro mt.
<b>AF413</b>	10	6,8	100 mt	1,65	1000	100 <b>2,35</b>
<b>AF909B</b>	15	11	25 mt	1,85	875	25 <b>3,10</b>
<b>AF905B</b>	15	11	50 mt	1,85	1250	50 <b>3,10</b>
<b>AF505B</b>	15	11	100 mt	1,85	1500	100 <b>3,10</b>
<b>AF906B</b>	22	18	25 mt	2,15	500	25 <b>5,83</b>
<b>AF506B</b>	22	18	50 mt	2,15	750	50 <b>5,83</b>
<b>AF910B</b>	28	22	25 mt	2,75	450	25 <b>11,02</b>



**Tubo in PB Barrier preisolato in rotolo**

Codice	D	d	A	B		Pallet	Conf. Euro mt.
<b>AF105B</b>	15	11	50 mt	blu	6 mm	650	50 <b>4,50</b>
<b>AF109B</b>	15	11	100 mt	blu	6 mm	1000	100 <b>4,50</b>
<b>AF106B</b>	22	18	25 mt	blu	6 mm	325	25 <b>7,39</b>
<b>AF108B</b>	22	18	50 mt	blu	6 mm	600	50 <b>7,39</b>
<b>AF110B</b>	28	22	25 mt	blu	6 mm	325	25 <b>11,76</b>

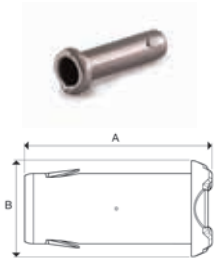

### Manicotto di sostegno in acciaio

Codice	D	d	A	B	Conf.	Euro pz.
<b>R AF958</b>	10	6,8	27	10	20	<b>0,78</b>
<b>AF947</b>	15	11	29	15	50	<b>0,56</b>
<b>AF934</b>	22	18	32	22	50	<b>0,76</b>
<b>AF570</b>	28	22	36	28	20	<b>1,29</b>

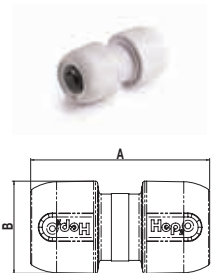

### Manicotto in PB

Codice	D	A	B	Conf.	Euro pz.
<b>AF516</b>	10	66	23	10	<b>3,97</b>
<b>AF507</b>	15	72	29	10	<b>3,75</b>
<b>AF508</b>	22	78	41	10	<b>5,35</b>
<b>AF707</b>	28	85	50	5	<b>9,79</b>

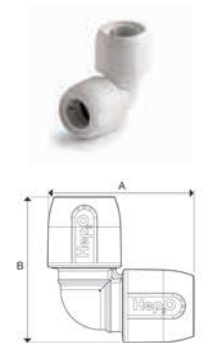

### Gomito 90° in PB

Codice	D	A	B	C	Conf.	Euro pz.
<b>R AF519</b>	10	48	48	23	10	<b>5,20</b>
<b>AF511</b>	15	59	59	29	10	<b>4,48</b>
<b>AF512</b>	22	71	71	41	10	<b>6,76</b>
<b>AF711</b>	28	82	82	50	5	<b>10,17</b>

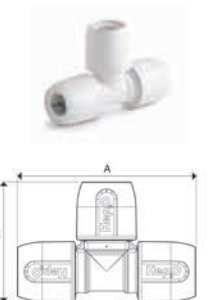

### Tee in PB

Codice	D	A	B	C	Conf.	Euro pz.
<b>R AF520</b>	10	75	48	23	10	<b>8,12</b>
<b>AF521</b>	15	88	59	30	10	<b>6,60</b>
<b>AF522</b>	22	101	71	40	10	<b>9,02</b>
<b>AF721</b>	28	114	82	50	5	<b>13,36</b>

R Contattare il Customer Service per tempistiche sulla disponibilità

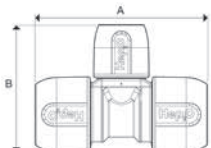

### Tee Ridotto in PB

Codice	D	A	B	C	Conf.	Euro pz.
R <b>AF531</b>	15x10x15	92	68	41	5	<b>7,92</b>
<b>AF524</b>	22x15x22	96	68	41	5	<b>9,02</b>
<b>AF724</b>	28x22x28	104	80	50	5	<b>13,98</b>

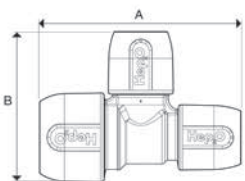

### Tee Ridotto in PB

Codice	D	A	B	C	Conf.	Euro pz.
<b>AF525</b>	22x15x15	92	69	41	5	<b>9,02</b>
<b>AF725</b>	28x22x22	104	80	50	5	<b>13,43</b>

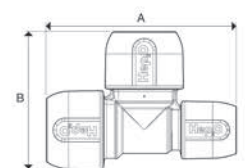

### Tee Ridotto in PB

Codice	D	A	B	C	Conf.	Euro pz.
<b>AF523</b>	22x22x15	98	71	40	5	<b>9,02</b>
R <b>AF723</b>	28x28x22	114	84	50	5	<b>14,63</b>

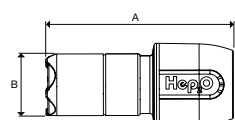

### Riduttore in PB

Codice	D	A	B	Conf.	Euro pz.
<b>AF510</b>	15x10	62	10	10	<b>7,21</b>
<b>AF509</b>	22x15	67	15	10	<b>4,78</b>
<b>AF709</b>	28x22	75	22	5	<b>6,69</b>

R Contattare il Customer Service per tempistiche sulla disponibilità

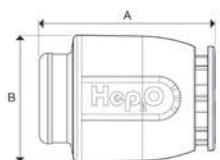

### Tappo Finale in PB

Codice	D	A	B	Conf.	Euro pz.
<b>R AF614</b>	10	37	23	10	<b>5,31</b>
<b>AF615</b>	15	41	29	10	<b>5,25</b>
<b>AF616</b>	22	44	41	10	<b>9,52</b>
<b>R AF617</b>	28	50	47	5	<b>9,93</b>

### Raccordo per collegamento a serbatoi

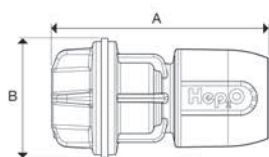

Codice	D	A	B	Conf.	Euro pz.
<b>R AF526</b>	15x1/2"	66	36	5	<b>5,86</b>

### Tappo per Raccordo in PB

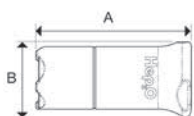

Codice	D	A	B	Conf.	Euro pz.
<b>R AF618</b>	10	50	10	10	<b>1,94</b>
<b>AF619</b>	15	54	15	10	<b>2,34</b>
<b>R AF620</b>	22	55	22	10	<b>3,59</b>
<b>* R AF621</b>	28	60	28	10	<b>6,85</b>

**R** Contattare il Customer Service per tempistiche sulla disponibilità - \* Ad esaurimento



### Raccordo terminale di testa in ottone

Codice	D	d	L	H	Conf.	Euro pz.
<b>AF626</b>	1/2"	15	72	55	5	<b>11,16</b>

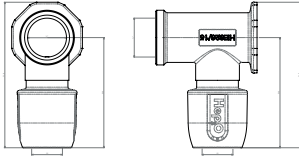

### Raccordo terminale di passaggio in ottone

Codice	D	d	L	H	Conf.	Euro pz.
<b>AF627</b>	1/2"	15	107	45	5	<b>15,97</b>

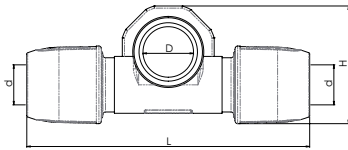

### Raccordo dritto femmina in ottone

Codice	D	d	L	Conf.	Euro pz.
<b>AF631</b>	1/2"	15	52	10	<b>7,10</b>
<b>AF633</b>	3/8"	15	52	10	<b>7,24</b>
<b>AF653</b>	1/2"	22	57	10	<b>9,54</b>
<b>AF657</b>	3/4"	22	57	10	<b>10,47</b>
<b>AF671</b>	1"	28	63	5	<b>16,31</b>

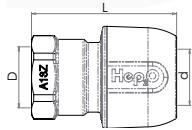

### Raccordo dritto maschio in ottone

Codice	D	d	L	Conf.	Euro pz.
<b>AF630</b>	1/2"	15	55	10	<b>6,02</b>
<b>AF652</b>	1/2"	22	61	10	<b>9,54</b>
<b>AF655</b>	3/4"	22	62	10	<b>8,74</b>
<b>AF670</b>	1"	28	67	5	<b>15,92</b>





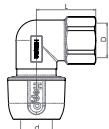

### Raccordo gomito femmina in ottone

Codice	D	d	L	Conf.	Euro pz.
<b>AF636</b>	1/2"	15	35	5	<b>9,22</b>
<b>AF656</b>	1/2"	22	41	5	<b>15,05</b>
<b>AF659</b>	3/4"	22	41	5	<b>13,99</b>
<b>AF676</b>	1"	28	48	5	<b>25,34</b>

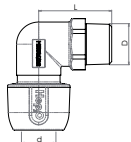

### Raccordo gomito maschio in ottone

Codice	D	d	L	Conf.	Euro pz.
<b>AF635</b>	1/2"	15	41	5	<b>8,82</b>
<b>AF658</b>	3/4"	22	47	5	<b>13,99</b>
<b>AF675</b>	1"	28	58	5	<b>25,06</b>

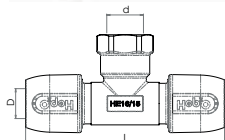

### Raccordo a Tee femmina in ottone

Codice	D	d	L	Conf.	Euro pz.
<b>AF639</b>	1/2"	15	101	5	<b>12,69</b>

### Adattatori femmina in ottone

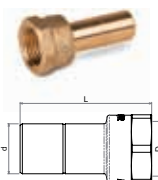

Codice	D	d	L	Conf.	Euro pz.
<b>AF540</b>	1/2"	15	54	10	<b>5,70</b>
<b>AF541</b>	3/4"	22	58	10	<b>8,42</b>
<b>R AF741</b>	1"	28	61	10	<b>13,12</b>

### Adattatori maschi in ottone

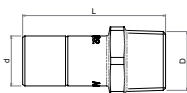
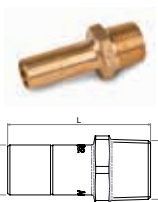

Codice	D	d	L	Conf.	Euro pz.
<b>AF542</b>	1/2"	15	59	10	<b>5,51</b>
<b>AF543</b>	3/4"	22	63	10	<b>9,03</b>

R Contattare il Customer Service per tempistiche sulla disponibilità

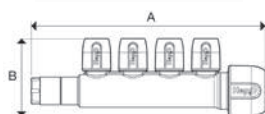
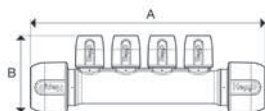

### Collettori lineari in PB

Codice	D	d	A	B	Vie	Attacco	Conf.	Euro pz.
R <b>AF762PLB</b>	22	15	145	66	2	Doppio	5	<b>13,60</b>
R <b>AF763PLB</b>	22	15	184	66	3	Doppio	5	<b>19,68</b>
R <b>AF764PL</b>	22	10	186	62	4	Cieco	5	<b>24,47</b>
R <b>AF762PL</b>	22	15	147	66	2	Cieco	5	<b>13,44</b>
R <b>AF763PL</b>	22	15	186	66	3	Cieco	5	<b>19,50</b>



### Collettori a croce in PB

Codice	D	d	A	B	Vie	Attacco	Conf.	Euro pz.
<b>AF962</b>	22	10	101	83	2	Doppio	5	<b>12,32</b>
<b>AF962PL</b>	22	10	99	83	2	Cieco	5	<b>11,77</b>

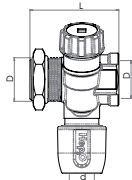

### Collettore con rubinetti 1 via in ottone nichelato

Codice	D	d	L	Conf.	Euro pz.
<b>AF991</b>	3/4"	15	54	1	<b>26,58</b>
<b>AF981</b>	3/4"	22	54	1	<b>29,90</b>

R Contattare il Customer Service per tempistiche sulla disponibilità

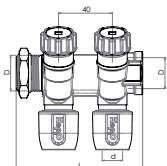

### Collettore con rubinetti 2 vie in ottone nichelato

Codice	D	d	L	Conf.	Euro pz.
<b>AF992</b>	3/4"	15	94	1	<b>43,97</b>

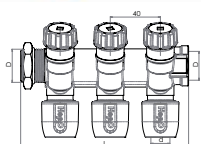

### Collettore con rubinetti 3 vie in ottone nichelato

Codice	D	d	L	Conf.	Euro pz.
<b>AF993</b>	3/4"	15	134	1	<b>56,27</b>

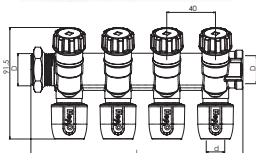

### Collettore con rubinetti 4 vie in ottone nichelato

Codice	D	d	L	Conf.	Euro pz.
<b>AF994</b>	3/4"	15	174	1	<b>75,29</b>



### Tappi per collettore in ottone nichelato

Codice	D	Attacco	Tipo	Conf.	Euro pz.
<b>AF665</b>	3/4"	F	Cieco	4	<b>2,61</b>
<b>AF666</b>	3/4"	M	Cieco	4	<b>4,47</b>

### Cassetta in plastica per collettore



Codice	H	L	P	Scat.	Conf.	Euro pz.
<b>AF692</b>	300	250	95	11	1	<b>24,20</b>
<b>AF693</b>	400	250	95	8	1	<b>30,90</b>
<b>AF694</b>	480	250	95	7	1	<b>38,07</b>
<b>R AF695</b>	Coppia staffe altezza differenziata per uscite dal basso				1	<b>4,59</b>

**R** Contattare il Customer Service per tempistiche sulla disponibilità

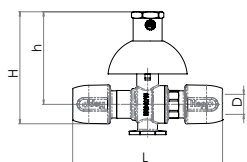

### Valvola a sfera ad incasso con codolo in ottone

Codice	D	H	h	L	Conf.	Euro pz.
<b>AF640N</b>	15	85	70	114	1	<b>37,37</b>

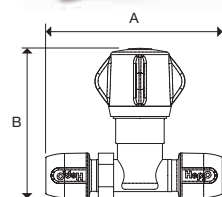

### Rubinetto di arresto in PB

Codice	D	A	B	Conf.	Euro pz.
<b>AF550</b>	15	116	98	5	<b>23,74</b>
<b>R AF551</b>	22	130	110	5	<b>27,71</b>

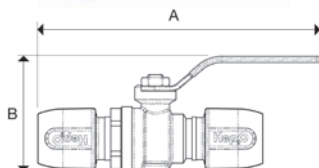

### Valvola a sfera con leva in ottone

Codice	D	A	B	Conf.	Euro pz.
<b>AF591</b>	15	140	55	5	<b>46,33</b>
<b>AF592</b>	22	170	70	5	<b>58,41</b>

R Contattare il Customer Service per tempistiche sulla disponibilità

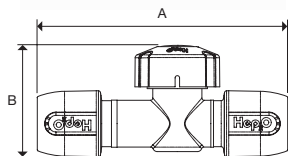

### Rubinetto di intercettazione in PB

Codice	D	A	B	Colore	Conf.	Euro pz.
<b>AF557</b>	15	112	50	rosso/blu	5	<b>16,31</b>

N.B. Per uso discontinuo di acqua calda e fredda temperatura max. 65°C, non indicato per i sistemi di riscaldamento centralizzato

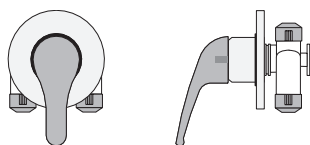

### Miscelatore completo in ottone

Codice	D	Conf.	Euro pz.
<b>R AF480</b>	15	1	<b>132,49</b>

### Accessori e ricambi per valvole a sfera in ottone

Codice	Descrizione	Conf.	Euro pz.
<b>R AF0644</b>	Canotto Cromato per AF640 - AF740	1	<b>10,67</b>
<b>* AF0645</b>	Rosetta bombata cromata per AF640-AF740	1	<b>4,19</b>
<b>* AF0641N</b>	Prolunga per AF640N- AF650N - AF750N	1	<b>23,26</b>

**R** Contattare il Customer Service per tempistiche sulla disponibilità - \* Ad esaurimento

# Sistema SLIDER

## Tubazioni sfilabili SLIDER

L'estrema flessibilità caratteristica delle tubazioni **SLIDER** in Polibutilene (PB) e le ridotte specifiche dimensionali sono garanzia di una perfetta "sfilabilità".

L'installatore può ispezionare o sostituire una tubazione, semplicemente facendola scorrere all'interno della guaina corrugata, senza dover rompere pavimenti e rivestimenti.

La tipologia di impianto a collettore, su cui si basa il sistema, consente la chiusura della sola utenza interessata dalla riparazione.

L'intervento è semplice anche per l'utente finale: il collettore, infatti, è dotato di targhette metalliche per l'identificazione dei circuiti (caldo-freddo) e delle varie utenze.

La disponibilità di rotoli di tubo **SLIDER** già pronto per essere installato semplifica all'operatore la posa in opera: non occorre altro che misurare e tagliare con l'apposita cesoia troncatubi i tratti di tubazione necessari.

I terminali ed i collettori sono dotati della pratica tipologia di innesto push-fit che riduce al minimo le operazioni necessarie per l'esecuzione del raccordo.

La tecnologia che caratterizza il sistema **SLIDER** è visibile nei vari componenti: la scatola, contenente il raccordo terminale, ha una geometria adatta anche a spessori di muratura estremamente ridotti; il collettore ha un innovativo dispositivo di avvitamento che permette di risolvere tutti i problemi di allineamento che si presentano al momento della giunzione di più elementi.

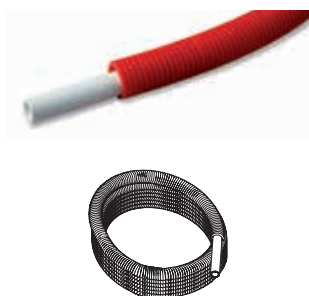

### Tubo Slider in PB preinserito in guaina corrugata

Codice	D	d	L	D ext.	Colore	pallet	Conf.	Euro mt.
<b>AF913B</b>	15	11	50 mt	25	rosso	600	50	<b>4,50</b>
<b>AF914B</b>	15	11	50 mt	25	blu	600	50	<b>4,50</b>
<b>AF900B</b>	22	18	50 mt	32	rosso	500	50	<b>7,13</b>
<b>AF901B</b>	22	18	50 mt	32	blu	600	50	<b>7,13</b>

### Raccordo terminale in ottone in scatola flangiata in plastica

Codice	L	h	H	Dxd	Colore	D	Conf.	Euro pz.
<b>AF780</b>	49,2	48	81,5	15x1/2"	verde		2	<b>15,34</b>

### Ricambi per Raccordo Terminale

<b>R AF0984</b>	Scatola in plastica e plug	verde	1	<b>3,24</b>
<b>* AF0987</b>	Morsetto in gomma - D.interno 25 mm	bianco 15 mm	1	<b>1,78</b>

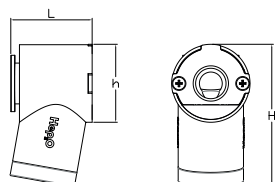

**R** Contattare il Customer Service per tempistiche sulla disponibilità - \* Ad esaurimento



### Testina guida tubo doppia in ottone

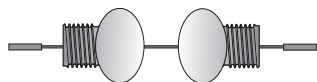

Codice	D	Conf.	Euro pz.
R <b>AF808</b>	15	1	<b>29,40</b>



### Rosone per terminale sfilabile



Codice	D	d	h	Conf.	Euro pz.
* <b>AF746</b>	1/2"	70	5	1	<b>1,81</b>



### Miscelatore completo in ottone

Codice	D	Conf.	Euro pz.
R <b>AF480</b>	15	1	<b>132,49</b>



### Ricambi per Miscelatore

R <b>AF0482</b>	Cartuccia	1	<b>30,62</b>
-----------------	-----------	---	--------------

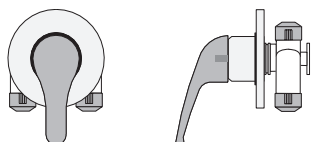

R Contattare il Customer Service per tempistiche sulla disponibilità - \* Ad esaurimento

# Sistema HepTherm



Il sistema **Heptherm** è costituito da tubazioni preisolate in PB, collettori e raccorderia ad innesto rapido. Le tubazioni **Heptherm** sono leggere e maneggevoli, resistenti e di lunga durata per le condizioni di pressione e temperatura impiegate nel riscaldamento, ma non sono idonee al passaggio di acqua potabile. L'isolamento è garantito da una guaina in polietilene (PE) espanso a struttura cellulare chiusa, con pellicola antigraffio di colore rosso. La

componentistica prevede collettori per riscaldamento ad innesto rapido.

Per il collegamento ai radiatori è disponibile una serie di raccordi in ottone, valvole e detentori, anche termostattizzabili la cui modalità di giunzione è sempre ad innesto rapido. La gamma prevede anche articoli che permettono l'utilizzazione di valvole e detentori di tipo tradizionale.



## Tubo Heptherm in PB preisolato in rotolo per riscaldamento

Codice	D	d	L	Spessore	Guaina	pallet	Conf.	Euro mt.
<b>AF118</b>	15	11	50 mt	6 mm	rossa	650	50	<b>3,72</b>
<b>AF129</b>	22	18	50 mt	6 mm	rossa	600	50	<b>5,90</b>
<b>AF122</b>	28	22	50 mt	6 mm	rossa	500	50	<b>9,14</b>

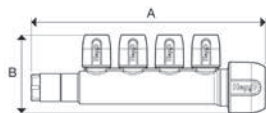
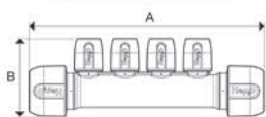

## Collettori lineari in PB

Codice	D	d	A	B	Vie	Attacco	Conf.	Euro pz.
<b>R AF762PLB</b>	22	15	145	66	2	Doppio	5	<b>13,60</b>
<b>R AF763PLB</b>	22	15	184	66	3	Doppio	5	<b>19,68</b>
<b>R AF762PL</b>	22	15	147	66	2	Cieco	5	<b>13,44</b>
<b>R AF763PL</b>	22	15	186	66	3	Cieco	5	<b>19,50</b>

## Collettori per riscaldamento in ottone rivestiti in TEA interasse 35 mm



Codice	D	d	L	Vie	Conf.	Euro pz.
<b>R AF762</b>	3/4"	15	110	2 vie	2	<b>33,51</b>
<b>R AF763</b>	3/4"	15	145	3 vie	2	<b>56,56</b>

**R** Contattare il Customer Service per tempistiche sulla disponibilità





### Tappi per collettore in ottone nichelato

Codice	D	Attacco	Tipo	Conf.	Euro pz.
<b>AF665</b>	3/4"	F	Cieco	4	<b>2,61</b>
<b>AF666</b>	3/4"	M	Cieco	4	<b>4,47</b>



### Terminale con tronchetto curvo in ottone e rame ricotto, nichelato

Codice	D	d	L	Conf.	Euro pz.
<b>AF727</b>	15	14	227	5	<b>17,09</b>



### Tronchetto di riduzione in rame

Codice	D	d	L	Conf.	Euro pz.
<b>AF624</b>	15	14	190	10	<b>8,20</b>

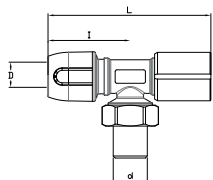

### Coppia valvola e detentore termostattizzabile

Codice	D	d	L	l	Conf.	Euro pz.
<b>R AF576</b>	15	1/2"	80	35	2	<b>32,55</b>

**R** Contattare il Customer Service per tempistiche sulla disponibilità

# Accessori per Sistemi di adduzione idrica e riscaldamento in Polibutilene



## Dima per terminali in ottone

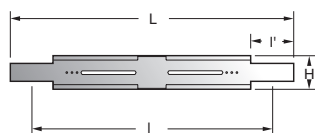

Codice	L	I	I'	H	Conf.	Euro pz.
<b>AF629</b>	330	280	50	37	10	<b>2,28</b>



## Reggicurva in acciaio tropicalizzato

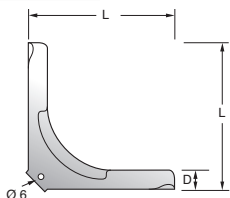

Codice	D	L	Conf.	Euro pz.
<b>AF577</b>	15	150	10	<b>4,17</b>
<b>R AF578</b>	22	270	5	<b>5,97</b>



## Clip di fissaggio in plastica

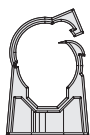

Codice	D	Conf.	Euro pz.
<b>AF581</b>	15	50	<b>0,30</b>
<b>AF582</b>	22	50	<b>0,55</b>
<b>AF781</b>	28	50	<b>0,97</b>



## Distanziatore per Clip

Codice	D	Conf.	Euro pz.
<b>AF600</b>	15	20	<b>12,56</b>
<b>AF601</b>	22-28	20	<b>12,56</b>

**R** Contattare il Customer Service per tempistiche sulla disponibilità

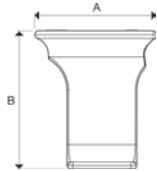

### Estrattore HepKey Plus

Codice	D	A	B	Conf.	Euro pz.
R <b>AF610</b>	10	31	39	10	<b>0,74</b>
<b>AF611</b>	15	35	39	10	<b>0,75</b>
<b>AF612</b>	22	45	41	10	<b>0,78</b>
<b>AF613</b>	28	53	41	10	<b>1,30</b>



### Estrattore Hep Metal Tool

Codice	D	A	B	Conf.	Euro pz.
R <b>AF608</b>	10-28	158	30	1	<b>3,10</b>
R <b>AF609</b>	15-22	158	38	1	<b>2,55</b>



### Tappo collaudo impianti

Codice	d	Colore	Scat.	Conf.	Euro pz.
R <b>AF595</b>	1/2"	rosso	100	10	<b>1,36</b>
R <b>AF596</b>	1/2"	blu	100	10	<b>1,36</b>



### Silicone lubrificante in spray 400 ml

Codice	Conf.	Euro pz.
<b>AF674</b>	1	<b>27,61</b>

R Contattare il Customer Service per tempistiche sulla disponibilità



### Cesoia per tubo

Codice	D	Conf.	Euro pz.
<b>AF579</b>	15-28	1	<b>79,23</b>



### Fascette identificative

Codice	Descrizione	Conf.	Euro pz.
<b>R AF986</b>	Fascetta identificativa blue	100	<b>0,90</b>
<b>R AF987</b>	Fascetta identificativa rossa	100	<b>0,90</b>

**R** Contattare il Customer Service per tempistiche sulla disponibilità

# Indoor Climate Solutions

- Climatizzazione radiante
- Ventilazione meccanica controllata
- Controlli



## Sistemi radianti a soffitto e parete



### Pannello a soffitto CD-4

Codice	Classe	Interasse profilo a C a C orditura di supporto	Sup.	Peso	A	B	H	Minimo Imballo d'ordine	Conf.	Euro
		mm	m <sup>2</sup>	kg/m <sup>2</sup>	mm	mm	mm			pz
<b>65100</b>	CFB	400	0,375	7	1000	400	35	1	1	<b>59,88</b>
<b>65120</b>	CFB	400	0,450	7	1200	400	35	1	1	<b>71,83</b>
<b>65140</b>	CFB	400	0,525	7	1400	400	35	1	1	<b>83,81</b>
<b>65160</b>	CFB	400	0,600	7	1600	400	35	1	1	<b>95,80</b>
<b>65180</b>	CFB	400	0,675	7	1800	400	35	1	1	<b>107,77</b>
<b>65200</b>	CFB	400	0,750	7	2000	400	35	1	1	<b>119,73</b>
<b>R 65220</b>	CFB	400	0,825	7	2200	400	35	1	1	<b>131,68</b>
<b>R 65240</b>	CFB	400	0,900	7	2400	400	35	1	1	<b>143,56</b>
<b>R 65260</b>	CFB	400	0,975	7	2600	400	35	1	1	<b>155,71</b>
<b>R 65280</b>	CFB	400	1,050	7	2800	400	35	1	1	<b>167,71</b>

**R** Contattare il Customer Service per tempistiche sulla disponibilità



### Pannello a soffitto CD-10i

Codice	Classe	Materiale isolante	Sup. m <sup>2</sup>	Peso kg/m <sup>2</sup>	A mm	B mm	H mm	Minimo d'ordine	Imballo	Conf.	Euro pz
<b>31103</b>	CFB	EPS 200	2,40	13	2000	1200	45	1	25	1	<b>315,49</b>
<b>31104</b>	CFB	EPS 200	1,20	13	1000	1200	45	1	25	1	<b>157,86</b>
<b>R 31105</b>	CFB	EPS 200	0,60	13	500	1200	45	1	50	1	<b>78,83</b>



### Pannello a parete WD-10i

Codice	Classe	Materiale isolante	Sup. m <sup>2</sup>	Peso kg/m <sup>2</sup>	A mm	B mm	H mm	Minimo d'ordine	Imballo	Conf.	Euro pz
<b>31203</b>	CFB	EPS 200	1,20	13	2000	600	45	1	50	1	<b>157,86</b>

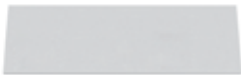

### Pannello passivo per tamponamento

Codice	Classe	Materiale isolante	Sup. m <sup>2</sup>	Peso kg/m <sup>2</sup>	A mm	B mm	H mm	Minimo d'ordine	Imballo	Conf.	Euro pz
<b>31901</b>	CFB	EPS 200	2,40	13	2000	1200	45	1	25	1	<b>143,32</b>

R Contattare il Customer Service per tempistiche sulla disponibilità



### Pannello sistema a soffitto e a parete WW-10

Codice	Classe	Ø tubo	Spes.	Sup.	A	B	H	Minimo Imballo d'ordine	Conf.	Euro
		mm	mm	m <sup>2</sup>	mm	mm	mm			pz
<b>80900</b>	CFB	10	1,3	1,20	2000	600	14	1	1	<b>134,56</b>
<b>R 80902</b>	CFB	10	1,3	1,13	1500	750	14	1	1	<b>134,56</b>



### Tubo PE-RT per sistemi WW-10

Codice	Classe	L	Ø tubo	Spes. tubo	Minimo Imballo d'ordine	Conf.	Euro
		m	mm	mm			m
<b>90220</b>	CFA	200	10	1,3	200	200	<b>1,51</b>



### Staffa per sistemi WW-10

Codice	Classe	Ø tubo	Minimo Imballo d'ordine	Conf.	Euro
		mm			pz
<b>90302</b>	CFC	10	20	20	<b>1,30</b>



### Barra per sistemi WW-10

Codice	Classe	Ø tubo	Interasse	A	B	H	Minimo Imballo d'ordine	Conf.	Euro
		mm	mm	mm	mm	mm			pz
<b>90303</b>	CFC	10	25	600	22	14	10 320	10	<b>2,24</b>

**R** Contattare il Customer Service per tempistiche sulla disponibilità





### Tubi multistrato per impianti a soffitto e parete

Codice	Classe	Alluminio	L	Ø tubo	Spes. tubo	Minimo d'ordine	Imballo	Conf.	Euro
		mm	m	mm	mm				m
<b>801420</b>	SA	0,40	100	20	2,5	100	1.300	100	<b>5,46</b>



### Tubi multistrato isolati per impianti a soffitto e parete

Codice	Classe	Alluminio	Insolam.	L	Ø tubo	Spes. tubo	Minimo d'ordine	Imballo	Conf.	Euro
		mm	mm	m	mm	mm				m
<b>811516</b>	SA	0,20	6	50	16	2,0	50	750	50	<b>3,89</b>
<b>817020</b>	SA	0,40	9	50	20	2,5	25	350	25	<b>7,80</b>

**Tee misto a compressione - innesto**

Codice	Classe	Ø tubo	Spes. tubo	Minimo Imballo d'ordine	Conf.	Euro
		mm	mm			pz
<b>80610</b>	CFC	16-10	2,0-1,3	10	10	<b>18,12</b>

**Manicotto misto a compressione - innesto**

Codice	Classe	Ø tubo	Spes. tubo	Minimo Imballo d'ordine	Conf.	Euro
		mm	mm			pz
<b>80710</b>	CFC	16-10	2,0-1,3	10	10	<b>17,20</b>

**Manicotto ad innesto**

Codice	Classe	Ø tubo	Spes. tubo	Minimo Imballo d'ordine	Conf.	Euro
		mm	mm			pz
<b>80810</b>	CFC	10	1,3	10	10	<b>10,86</b>

**Kit di riparazione**

Codice	Classe	Ø tubo	Spes. tubo	Minimo Imballo d'ordine	Conf.	Euro
		mm	mm			pz
<b>95600</b>	CFC	10	1,3	1	1	<b>26,99</b>



### Manicotto a compressione

Codice	Classe	Profilo	Ø tubo	Spes. tubo	Minimo d'ordine	Imballo	Conf.	Euro
			mm	mm				pz
<b>850010</b>	SB	CH	16	2,0	10	60	10	<b>10,80</b>
<b>850012</b>	SB	CH	20	2,5	10	60	10	<b>11,52</b>



### Manicotto ridotto a compressione

Codice	Classe	Profilo	Ø tubo	Spes. tubo	Minimo d'ordine	Imballo	Conf.	Euro
			mm	mm				pz
<b>850021</b>	SB	CH	20-16	2,5-2,0	10	60	10	<b>11,13</b>



### Gomito 90° a compressione

Codice	Classe	Profilo	Ø tubo	Spes. tubo	Minimo d'ordine	Imballo	Conf.	Euro
			mm	mm				pz
<b>850110</b>	SB	CH	16	2,0	10	60	10	<b>13,70</b>
<b>850112</b>	SB	CH	20	2,5	10	60	10	<b>14,48</b>

## Sistemi radianti a pavimento



## Pannello Renova

Codice	Classe	Mat.	Res. Comp.	Res. Ter.	Sup.	A	B	H	Minimo d'ordine	Imballo	Conf.	Euro
			10% kPa	m <sup>2</sup> K/W	m <sup>2</sup>	mm	mm	mm				m <sup>2</sup>
<b>101661</b>	FB				0,96	1200	800	22	10,56	147,84	10,56	<b>44,36</b>

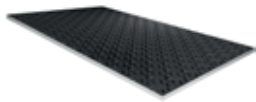

## Pannello Renova Trio

Codice	Classe	Mat.	Res. Comp.	Res. Ter.	Sup.	A	B	H	Minimo d'ordine	Imballo	Conf.	Euro
			10% kPa	EN 1264 2021 m <sup>2</sup> K/W	m <sup>2</sup>	mm	mm	mm				m <sup>2</sup>
<b>101667</b>	FB	EPS400	400	0,15	1,12	1400	800	23	13,44	107,52	13,44	<b>43,01</b>
<b>101668</b>	FB	EPS300	300	0,75	1,12	1400	800	42	16,80	67,20	16,80	<b>57,67</b>
<b>101669</b>	FB	EPS300	300	1,25	1,12	1400	800	58	11,20	44,80	11,20	<b>70,80</b>

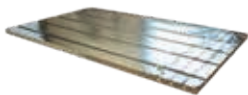

## Pannello Dry (solo tubo DN16)

Codice	Classe	Mat.	Res. Comp.	Res. Ter.	Sup.	A	B	H	Minimo d'ordine	Imballo	Conf.	Euro
			10% kPa	m <sup>2</sup> K/W	m <sup>2</sup>	mm	mm	mm				m <sup>2</sup>
<b>101409</b>	FB	EPS300	300	0,75	0,90	1200	750	26	13,50	81,00	13,50	<b>100,80</b>
<b>NEW</b> <b>4083482</b>	FB	EPS300	300	0,60	0,72	1200	600	25	9,36	56,16	9,36	<b>100,80</b>
<b>NEW</b> <b>4083483</b>	FB	EPS300	300	0,75	0,72	1200	600	30	7,92	47,52	7,92	<b>110,80</b>



### Nastro adesivo

Codice	Classe	Materiale	Resistenza alla trazione	L	P	Spes.	Minimo Imballo d'ordine	Conf.	Euro
			N/25 mm	m	mm	mm			pz
<b>140290</b>	VMC	Alluminio	65-70	50	50	0,04	1	1	<b>39,10</b>

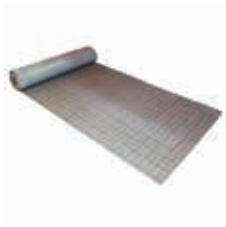

### Materassino Mat Run

Codice	Classe	Mat.	Res Ter.	Sup.	A	B	H	Minimo Imballo d'ordine	Conf.	Euro
			m <sup>2</sup> K/W	m <sup>2</sup>	mm	mm	mm			m <sup>2</sup>
<b>101705</b>	FB	Fibre	-	20,00	20000	1000	2	20,00 300,00	20,00	<b>27,99</b>

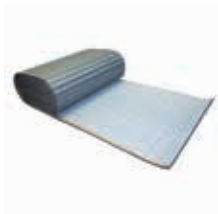

### Pannello Roller Run Ultra

Codice	Classe	Mat.	Res Comp.	Res Ter.	Sup.	A	B	H	Minimo Imballo d'ordine	Conf.	Euro
			10% kPa	m <sup>2</sup> K/W	m <sup>2</sup>	mm	mm	mm			m <sup>2</sup>
* <b>101725</b>	FB	EPS150	150	0,80	10,00	10000	1000	25	10,00 60,00	10,00	<b>35,22</b>
* <b>101745</b>	FB	EPS150	150	1,30	10,00	10000	1000	40	10,00 40,00	10,00	<b>43,32</b>
<b>NEW</b> <b>4083926</b>	FB	EPS150	150	0,77	10,00	10000	1000	23	10,00 70,00	10,00	<b>32,73</b>
<b>NEW</b> <b>4083927</b>	FB	EPS150	150	1,27	10,00	10000	1000	38	10,00 50,00	10,00	<b>41,20</b>



### Pannello Acoustic Run

Codice	Classe	Mat.	Car acus.	Res Ter.	Sup.	A	B	H	Minimo Imballo d'ordine	Conf.	Euro
				m <sup>2</sup> K/W	m <sup>2</sup>	mm	mm	mm			m <sup>2</sup>
* <b>101736</b>	FB	EPS-T	SD20 CP2	0,75	10,00	10000	1000	30	10,00 60,00	10,00	<b>27,62</b>

\* Ad esaurimento



## Pannello Reflex Ultra

Codice	Classe	Mat.	Res. Comp.	Res. Ter.	Sup.	A	B	H	Minimo d'ordine	Imballo	Conf.	Euro
			10% kPa	m <sup>2</sup> K/W	m <sup>2</sup>	mm	mm	mm				m <sup>2</sup>
<b>111110</b>	FB	EPS200	200	0,30	0,50	1000	500	10	15,00	180,00	15,00	<b>58,32</b>
<b>111123</b>	FB	EPS200	200	0,75	0,50	1000	500	23	13,00	104,00	13,00	<b>63,54</b>
<b>NEW 3095006</b>	FB	EPS200	200	1,25	0,50	1000	500	38	7,50	60,00	7,50	<b>70,56</b>
* <b>111139</b>	FB	EPS200	200	1,25	0,50	1000	500	39	7,50	60,00	7,50	<b>70,56</b>
<b>111146</b>	FB	EPS200	200	1,50	0,50	1000	500	46	6,00	48,00	6,00	<b>84,39</b>



## Pannello Master Ultra

Codice	Classe	Mat.	Res. Comp.	Res. Ter.	Sup.	A	B	H	Minimo d'ordine	Imballo	Conf.	Euro
			10% kPa	m <sup>2</sup> K/W	m <sup>2</sup>	mm	mm	mm				m <sup>2</sup>
<b>111623</b>	FB	EPS200	200	0,75	0,72	1200	600	23	10,08	120,96	10,08	<b>32,03</b>
<b>NEW 4084005</b>	FB	EPS200	200	1,25	0,72	1200	600	38	5,00	80,60	5,00	<b>42,09</b>
* <b>111639</b>	FB	EPS200	200	1,25	0,72	1200	600	39	5,04	80,64	5,04	<b>42,09</b>



## Pannello Roller Acoustic Ultra

Codice	Classe	Mat.	Car. acus.	Res. Ter.	Sup.	A	B	H	Minimo d'ordine	Imballo	Conf.	Euro
					m <sup>2</sup> K/W	m <sup>2</sup>	mm	mm	mm			m <sup>2</sup>
* <b>101722</b>	FB	EPS-T	SD30 CP2	0,80	10,00	10000	1000	25	10,00	60,00	10,00	<b>25,26</b>



## Pannello Roller

Codice	Classe	Mat.	Res. Comp.	Res. Ter.	Sup.	A	B	H	Minimo d'ordine	Imballo	Conf.	Euro
			10% kPa	m <sup>2</sup> K/W	m <sup>2</sup>	mm	mm	mm				m <sup>2</sup>
<b>R 101720</b>	FB	EPS150	150	0,55	10,00	10000	1000	20	10,00	80,00	10,00	<b>25,17</b>
<b>NEW 4083934</b>	FB	EPS150	150	0,75	10,00	10000	1000	23	10,00	80,00	10,00	<b>26,82</b>
<b>NEW 4083935</b>	FB	EPS150	150	1,25	6,00	6000	1000	38	6,00	48,00	6,00	<b>33,60</b>

R Contattare il Customer Service per tempistiche sulla disponibilità. - \* Ad esaurimento

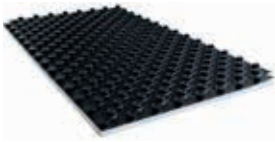

### Pannello Simple Silver

	Codice	Classe	Mat.	Res. Comp.	Res. Ter.	Sup.	A	B	H	Minimo d'ordine	Imballo	Conf.	Euro
				10% kPa	EN 1264 2021 m <sup>2</sup> K/W	m <sup>2</sup>	mm	mm	mm				m <sup>2</sup>
<b>NEW</b>	<b>4083936</b>	FB	EPS150	150	0,30	1,12	1400	800	32	26,88	107,52	26,88	<b>28,60</b>
	<b>101685</b>	FB	EPS150	150	0,75	1,12	1400	800	45	15,68	62,72	15,68	<b>32,46</b>
	<b>101686</b>	FB	EPS150	150	1,25	1,12	1400	800	60	11,20	44,80	11,20	<b>40,83</b>
<b>R</b>	<b>101687</b>	FB	EPS150	150	1,50	1,12	1400	800	67	403,20	40,32	10,08	<b>47,00</b>
<b>R</b>	<b>101688</b>	FB	EPS150	150	2,00	1,12	1400	800	82	313,60	31,36	7,84	<b>59,48</b>

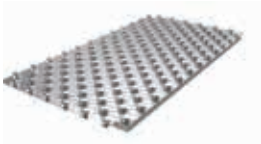

### Pannello Acoustic Ultra 30-2

	Codice	Classe	Mat.	Car. acus.	Res. Ter.	Res. Ter.	Sup.	A	B	H	Minimo d'ordine	Imballo	Conf.	Euro
					EN 1264 2021 m <sup>2</sup> K/W	EN 1264 2009 m <sup>2</sup> K/W	m <sup>2</sup>	mm	mm	mm				m <sup>2</sup>
<b>*</b>	<b>101673</b>	FB	EPS-T + EPS	SD20 CP2	1,00	1,15	0,96	1200	800	52	9,60	48,00	9,60	<b>42,57</b>



### Pannello Simple White

	Codice	Classe	Mat.	Res. Comp.	Res. Ter.	Sup.	A	B	H	Minimo d'ordine	Imballo	Conf.	Euro
				10% kPa	EN 1264 2021 m <sup>2</sup> K/W	m <sup>2</sup>	mm	mm	mm				m <sup>2</sup>
<b>R</b>	<b>101681</b>	FB	EPS150	150	0,30	1,12	1400	800	32	1075,20*	107,52	26,88	<b>25,80</b>
<b>R</b>	<b>101682</b>	FB	EPS150	150	0,65	1,12	1400	800	42	1075,20*	67,20	16,80	<b>28,62</b>
<b>R</b>	<b>4083101</b>	FB	EPS150	150	0,75	1,12	1400	800	48	940,80*	62,72	15,68	<b>30,74</b>
<b>R</b>	<b>4083102</b>	FB	EPS150	150	1,25	1,12	1400	800	65	470,40*	44,80	11,20	<b>37,15</b>

\*Vendita con minimo d'ordine, per quantitativi superiori rispettare il multiplo d'imballo.

**R** Contattare il Customer Service per tempistiche sulla disponibilità. - \* Ad esaurimento

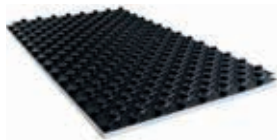

**Pannello Simple White-P**

	Codice	Classe	Mat.	Res. Comp.	Res. Ter.	Sup.	A	B	H	Minimo d'ordine	Imballo	Conf.	Euro
				10% kPa	EN 1264 2021 m <sup>2</sup> K/W	m <sup>2</sup>	mm	mm	mm				m <sup>2</sup>
<b>NEW</b>	R 4083655	FB	EPS150	150	0,29	1,12	1400	800	32	369,60*	123,20	24,64	<b>23,79</b>
<b>NEW</b>	R 4083656	FB	EPS150	150	0,59	1,12	1400	800	42	268,80*	89,60	17,92	<b>26,39</b>
<b>NEW</b>	R 4083657	FB	EPS150	150	0,76	1,12	1400	800	48	235,20*	78,40	15,68	<b>28,21</b>
<b>NEW</b>	R 4083658	FB	EPS150	150	1,26	1,12	1400	800	65	151,20*	50,40	10,08	<b>34,44</b>

\*Vendita con minimo d'ordine, per quantitativi superiori rispettare il multiplo d'imballo.

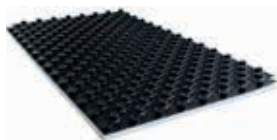

**Pannello Simple White-P CAM**

	Codice	Classe	Mat.	Res. Comp.	Res. Ter.	Sup.	A	B	H	Minimo d'ordine	Imballo	Conf.	Euro
				10% kPa	EN 1264 2021 m <sup>2</sup> K/W	m <sup>2</sup>	mm	mm	mm				m <sup>2</sup>
<b>NEW</b>	4083991	FB	EPS150	150	0,29	1,12	1400	800	32	24,64	98,56	24,64	<b>24,90</b>
<b>NEW</b>	4083992	FB	EPS150	150	0,59	1,12	1400	800	42	17,92	71,68	17,92	<b>27,53</b>
<b>NEW</b>	4083993	FB	EPS150	150	0,76	1,12	1400	800	48	15,68	62,72	15,68	<b>29,45</b>
<b>NEW</b>	4083994	FB	EPS150	150	1,26	1,12	1400	800	65	10,08	40,32	10,08	<b>35,87</b>

NOTA: Il pannello è prodotto con materiale riciclato rispettando i Criteri Ambientali Minimi indicati nel Decreto del 23 giugno 2022.



**Pannello Simple-L**

	Codice	Classe	Mat.	Res. Ter.	Res. Ter.	Sup.	A	B	H	Minimo d'ordine	Imballo	Conf.	Euro
				EN 1264 2021 m <sup>2</sup> K/W	EN 1264 2009 m <sup>2</sup> K/W	m <sup>2</sup>	mm	mm	mm				m <sup>2</sup>
	R 101641L	FB	EPS100	0,25	0,40	0,96	1200	800	32	2332,80	86,40*	17,28	<b>25,80</b>
	R 101646L	FB	EPS100	0,55	0,70	0,96	1200	800	42	1684,80	62,40*	12,48	<b>27,32</b>
	R 101647L	FB	EPS100	0,80	0,90	0,96	1200	800	50	1296,00	48,00*	9,60	<b>31,79</b>

\*Vendita con minimo d'ordine, per quantitativi superiori rispettare il multiplo d'imballo.

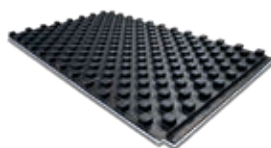

**Pannello Compact Black**

	Codice	Classe	Mat.	Res. Comp.	Res. Ter.	Sup.	A	B	H	Minimo d'ordine	Imballo	Conf.	Euro
				10% kPa	EN 1264 2021 m <sup>2</sup> K/W	m <sup>2</sup>	mm	mm	mm				m <sup>2</sup>
<b>NEW</b>	4083835	FB	EPS200	200	0,75	0,96	1200	800	51	12,48	49,92	12,48	<b>25,37</b>
<b>NEW</b>	4083836	FB	EPS200	200	1,25	0,96	1200	800	67	8,64	34,56	8,64	<b>29,70</b>

R Contattare il Customer Service per tempistiche sulla disponibilità - \* Ad esaurimento





### Pannello Industrial

Codice	Classe	Mat.	Res. Comp.	Res. Ter.	Sup.	A	B	H	Minimo d'ordine	Imballo	Conf.	Euro
			10% kPa	m <sup>2</sup> K/W	m <sup>2</sup>	mm	mm	mm				m <sup>2</sup>
<b>R 101822</b>	FB	XPS250	250	0,60	0,75	1250	600	20	756,00	189,00*	15,75	<b>13,13</b>
<b>R 101833</b>	FB	XPS300	300	0,90	0,75	1250	600	30	504,00	126,00*	10,50	<b>18,12</b>
<b>R 101843</b>	FB	XPS300	300	1,20	0,75	1250	600	40	360,00	90,00*	7,50	<b>24,14</b>
<b>R 101853</b>	FB	XPS300	300	1,50	0,75	1250	600	50	288,00	72,00*	6,00	<b>30,20</b>
<b>R 101863</b>	FB	XPS300	300	1,80	0,75	1250	600	60	252,00	63,00*	5,25	<b>36,20</b>
<b>R 101883</b>	FB	XPS300	300	2,25	0,75	1250	600	80	180,00	45,00*	3,75	<b>48,29</b>
<b>R 1018A3</b>	FB	XPS300	300	2,80	0,75	1250	600	100	144,00	36,00*	3,00	<b>60,36</b>
<b>R 101855</b>	FB	XPS500	500	1,50	0,75	1250	600	50	288,00	72,00*	6,00	<b>36,52</b>
<b>R 101865</b>	FB	XPS500	500	1,80	0,75	1250	600	60	252,00	63,00*	5,25	<b>43,87</b>
<b>R 101885</b>	FB	XPS500	500	2,25	0,75	1250	600	80	180,00	45,00*	3,75	<b>58,47</b>
<b>R 1018A5</b>	FB	XPS500	500	2,80	0,75	1250	600	100	144,00	36,00*	3,00	<b>73,10</b>
<b>R 101867</b>	FB	XPS700	700	1,80	0,75	1250	600	60	252,00	63,00*	5,25	<b>66,06</b>
<b>R 101887</b>	FB	XPS700	700	2,25	0,75	1250	600	80	180,00	45,00*	3,75	<b>88,10</b>
<b>R 1018A7</b>	FB	XPS700	700	2,80	0,75	1250	600	100	144,00	36,00*	3,00	<b>110,11</b>

\* Vendita con minimo d'ordine, per quantitativi superiori rispettare il multiplo d'imballo.

**R** Contattare il Customer Service per tempistiche sulla disponibilità.



### Tubo Polystop multistrato per impianti a pavimento

Codice	Classe	Materiale	L	Ø	Spes.	Minimo Imballo d'ordine	Conf.	Euro
			m	mm	mm			m
<b>102517</b>	FA	PE-RT (II) / Al / PE-RT (II)	200	17	2,0	200 1200	200	<b>3,77</b>
<b>102717</b>	FA	PE-RT (II) / Al / PE-RT (II)	500	17	2,0	200 1500	500	<b>3,77</b>

### Tubo Polystop Basic per impianti a pavimento



Codice	Classe	Materiale	L	Ø	Spes.	Minimo Imballo d'ordine	Conf.	Euro
			m	mm	mm			m
<b>102814</b>	FA	PE-RT (II)/Al/PE-RT (II)	200	14	2,0	200 3200	200	<b>2,35</b>
<b>102914</b>	FA	PE-RT (II)/Al/PE-RT (II)	500	14	2,0	500 2000	500	<b>2,35</b>
<b>841516</b>	FA	PE-RT (II)/Al/PE-RT (II)	200	16	2,0	200 2600	200	<b>2,26</b>
<b>831516</b>	FA	PE-RT (II)/Al/PE-RT (II)	500	16	2,0	500 2000	500	<b>2,26</b>



### Tubo Polyrun PE-Xa 5 strati per impianti a pavimento

Codice	Classe	Materiale	L	Ø	Spes.	Minimo Imballo d'ordine	Conf.	Euro
			m	mm	mm			m
<b>112516</b>	FA	PE-Xa/EVOH/PE-RT (II)	200	16	1,5	200 4000	200	<b>4,62</b>
<b>112716</b>	FA	PE-Xa/EVOH/PE-RT (II)	500	16	1,5	500 4000	500	<b>4,62</b>



### Tubo Polysuper PE-Xa 5 strati per impianti a pavimento

Codice	Classe	Materiale	L	Ø	Spes.	Minimo Imballo d'ordine	Conf.	Euro
			m	mm	mm			m
<b>112817</b>	FA	PE-Xa/EVOH/PE-RT (II)	200	17	2,0	200 4000	200	<b>3,14</b>
<b>112917</b>	FA	PE-Xa/EVOH/PE-RT (II)	500	17	2,0	500 4000	500	<b>3,14</b>
<b>112920</b>	FA	PE-Xa/EVOH/PE-RT (II)	500	20	2,0	500 3000	500	<b>3,69</b>
<b>R 112825</b>	FA	PE-Xa/EVOH/PE-RT (II)	300	25	2,3	300 1200	300	<b>5,52</b>



### Tubo Polysuper Basic 5 strati per impianti a pavimento

Codice	Classe	Materiale	L	Ø	Spes.	Minimo Imballo d'ordine	Conf.	Euro
			m	mm	mm			m
<b>122817</b>	FA	PE-RT (II)/EVOH/PE-RT (II)	200	17	2,0	200 4000	200	<b>2,13</b>
<b>122917</b>	FA	PE-RT (II)/EVOH/PE-RT (II)	500	17	2,0	500 4000	500	<b>2,13</b>

**R** Contattare il Customer Service per tempistiche sulla disponibilità.



### Clip per pannelli piani

Codice	Classe	Materiale	Colore	A pann. mm	Ø tubo mm	Spes. clip mm	Minimo d'ordine	Imballo	Conf.	Euro pz
<b>103101</b>	FC	Plastico	Blu	≥ 20	16÷20	7,9	1000	1000		<b>0,20</b>
<b>103111</b>	FC	Plastico	Nero	≥ 10	16÷17	7,9	1000	1000		<b>0,21</b>



### Clip per pannelli a nocche

Codice	Classe	Materiale	H pann. mm	Ø tubo mm	Spes. clip mm	Minimo d'ordine	Imballo	Conf.	Euro pz
<b>103200</b>	FC	Plastico	≥ 30	16÷20	2,7	50	50		<b>0,27</b>



### Barra di modulazione adesiva

Codice	Classe	Materiale	Tipo	Ø Tubo mm	A mm	B mm	Interasse mm	Minimo d'ordine	Imballo	Conf.	Euro m
<b>R 104010</b>	FC	Plastico	A	16÷22	1000	50	50÷100	100	1500	100	<b>6,27</b>
<b>R 104220</b>	FC	Plastico	B	20	2000	50	50	96	896	32	<b>6,78</b>
<b>R 104225</b>	FC	Plastico	C	25	2000	50	50	96	800	32	<b>11,07</b>



### Fascetta di nylon

Codice	Classe	Materiale	Q.tà pz/m	A mm	B mm	Minimo d'ordine	Imballo	Conf.	Euro pz
<b>R 104715</b>	FC	Plastico	1,0	250	4,8	100	100		<b>0,20</b>

**R** Contattare il Customer Service per tempistiche sulla disponibilità.



### Giunto perimetrale adesivo per sistemi ribassati

Codice	Classe	Materiale	Film PE	A	B	H	Minimo Imballo d'ordine	Conf.	Euro
				m	mm	mm			m
<b>104153</b>	FC	PE-LD	No	25	100	6	25	25	<b>4,18</b>



### Giunto perimetrale adesivo

Codice	Classe	Materiale	Film PE	A	B	H	Minimo Imballo d'ordine	Conf.	Euro
				m	mm	mm			m
<b>104150</b>	FC	PE-LD	Si	50	150	8	50	50	<b>2,19</b>
<b>R 104152</b>	FC	PE-LD	Si	50	250	10	50	50	<b>3,66</b>



### Giunto di dilatazione strutturale adesivo

Codice	Classe	Materiale	Adesivo	A	B	H	Minimo Imballo d'ordine	Conf.	Euro	
				mm	mm	mm			m	
<b>104171</b>	FC	PE-MD	si	2000	105	7	10	90	10	<b>10,96</b>



### Foglio in polietilene

Codice	Classe	Materiale	Spessore d'aria eq.	Sup.	A	B	Spes.	Minimo Imballo d'ordine	Conf.	Euro
			m	m <sup>2</sup>	m	m	μm			m <sup>2</sup>
<b>104740</b>	FC	PE	70	200	67	3	200	200	200	<b>2,60</b>

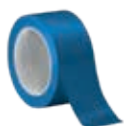

### Nastro adesivo per foglio in polietilene

Codice	Classe	Materiale	L	P	Minimo Imballo d'ordine	Conf.	Euro
			m	mm			pz
<b>R 104741</b>	FC	PVC	66	50	1	1	<b>14,29</b>

**R** Contattare il Customer Service per tempistiche sulla disponibilità.



### Rete antiritiro metallica

Codice	Classe	Materiale	Maglia.	A	B	Spes.	Minimo Imballo d'ordine	Conf.	Euro
			mm	mm	mm	µm			pz
<b>104805</b>	FC	Acciaio zincato	50x50	2000	1000	1,75	20	20	<b>9,00</b>



### Fibre sintetiche per massetto - Scatola da 3 kg

Codice	Classe	Materiale	Resist. a Trazione	Dosaggio	Contenuto scatola	Minimo Imballo d'ordine	Conf.	Euro
			MPa	Kg/m <sup>3</sup>	Kg			pz
<b>104811</b>	FC	PP	400÷450	1,0÷4,0	2x1,5	1	30	1 <b>173,12</b>



### Additivo fluidificante FLUTERM-S - Tanica da 10 litri

Codice	Classe	Materiale	Dosaggio	Contenuto tanica	Minimo Imballo d'ordine	Conf.	Euro
			l/100kg	l			pz
<b>105021</b>	FC	Liquido	1,0	10	1	40	1 <b>80,71</b>



### Additivo inibitore SANOTHERM 400 - Tanica da 1 kg

Codice	Classe	Materiale	Dosaggio	Contenuto tanica	Minimo Imballo d'ordine	Conf.	Euro
			kg/100l	kg			pz
<b>105030</b>	FC	Liquido	1,0	1	1	1	<b>78,68</b>



### Additivo pulitore SANOTHERM 700 - Tanica da 5 kg

Codice	Classe	Materiale	Dosaggio	Contenuto tanica	Minimo Imballo d'ordine	Conf.	Euro
			kg/100l	kg			pz
<b>R 105040</b>	FC	Liquido	5÷10	5	1	1	<b>227,30</b>



### Coppia raccordi per termoarredi

Codice	Classe	Attacchi	Ø Tubo	Spes. tubo	Minimo Imballo d'ordine	Conf.	Euro
		pollici	mm	mm			pz
<b>109110</b>	FC	3/4" F	14	1,3	1	1	<b>37,20</b>



### Nipple per giunto meccanico

Codice	Classe	Attacchi	Minimo Imballo d'ordine	Conf.	Euro
		pollici			pz
<b>106530</b>	FC	3/4" Ek	1	1	<b>13,02</b>



### Giunto a compressione

Codice	Classe	Profilo	Ø Tubo	Spes. tubo	Minimo Imballo d'ordine	Conf.	Euro
			mm	mm			pz
<b>109117</b>	FC	CH	17	2,0	1	1	<b>18,49</b>
<b>R 109121</b>	FC	U	20	2,0	1	1	<b>18,42</b>

R Contattare il Customer Service per tempistiche sulla disponibilità.

## Collettori

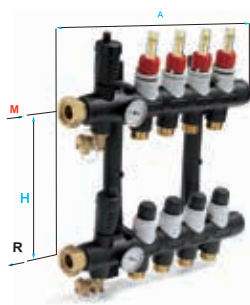

## Collettore TEMPOWER 2G montato

Codice	Classe	N° vie	Portata	Attacchi utenze	Attacchi caldaia	A	B	H	Minimo d'ordine	Imballo	Conf.	Euro
			l/min			mm	mm	mm				pz
<b>116502</b>	FD	2	4	3/4" EK	1" F	245	80	210	1	1	1	<b>232,93</b>
<b>116503</b>	FD	3	4	3/4" EK	1" F	295	80	210	1	1	1	<b>284,00</b>
<b>116504</b>	FD	4	4	3/4" EK	1" F	345	80	210	1	1	1	<b>327,20</b>
<b>116505</b>	FD	5	4	3/4" EK	1" F	395	80	210	1	1	1	<b>376,49</b>
<b>116506</b>	FD	6	4	3/4" EK	1" F	445	80	210	1	1	1	<b>428,02</b>
<b>116507</b>	FD	7	4	3/4" EK	1" F	495	80	210	1	1	1	<b>476,94</b>
<b>116508</b>	FD	8	4	3/4" EK	1" F	545	80	210	1	1	1	<b>524,07</b>
<b>116509</b>	FD	9	4	3/4" EK	1" F	595	80	210	1	1	1	<b>580,50</b>
<b>116510</b>	FD	10	4	3/4" EK	1" F	645	80	210	1	1	1	<b>639,77</b>
<b>116511</b>	FD	11	4	3/4" EK	1" F	695	80	210	1	1	1	<b>697,13</b>
<b>116512</b>	FD	12	4	3/4" EK	1" F	745	80	210	1	1	1	<b>752,25</b>



## Collettore TEMPOWER 2G ad imballi - 1 via aggiuntiva

Codice	Classe	N° vie	Portata	Attacchi utenze	Attacchi caldaia	A	B	H	Minimo d'ordine	Imballo	Conf.	Euro
			l/min			mm	mm	mm				pz
<b>116500</b>	FD	1	4	3/4" EK		50	80	210	1	104	1	<b>73,97</b>



## Collettore TEMPOWER 2G ad imballi - 3 vie aggiuntive

Codice	Classe	N° vie	Portata	Attacchi utenze	Attacchi caldaia	A	B	H	Minimo d'ordine	Imballo	Conf.	Euro
			l/min			mm	mm	mm				pz
<b>116533</b>	FD	3	4	3/4" EK		150	80	210	1	48	1	<b>134,26</b>



## Collettore TEMPOWER 2G ad imballi - Starter pack

Codice	Classe	N° vie	Portata	Attacchi utenze	Attacchi caldaia	A	B	H	Minimo d'ordine	Imballo	Conf.	Euro
			l/min			mm	mm	mm				pz
<b>116536</b>	FD	Starter			1" F	145	80	210	1	20	1	<b>131,41</b>



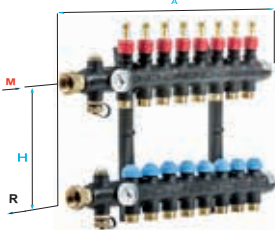

## Collettore TEMPOWER2GBASICmontato

Codice	Classe	N°vie	Portata	Attacchi utenze	Attacchi A caldaia	B	H	Minimo d'ordine	Imballo	Conf.	Euro
			l/min			mm	mm				pz
<b>116702</b>	FD	2	4	3/4"EK	1"F	245	82	210	1	1	<b>199,37</b>
<b>116703</b>	FD	3	4	3/4"EK	1"F	295	82	210	1	1	<b>244,48</b>
<b>116704</b>	FD	4	4	3/4"EK	1"F	345	82	210	1	1	<b>285,55</b>
<b>116705</b>	FD	5	4	3/4"EK	1"F	395	82	210	1	1	<b>331,48</b>
<b>116706</b>	FD	6	4	3/4"EK	1"F	445	82	210	1	1	<b>377,91</b>
<b>116707</b>	FD	7	4	3/4"EK	1"F	495	82	210	1	1	<b>423,97</b>
<b>116708</b>	FD	8	4	3/4"EK	1"F	545	82	210	1	1	<b>468,25</b>
<b>116709</b>	FD	9	4	3/4"EK	1"F	595	82	210	1	1	<b>516,58</b>
<b>116710</b>	FD	10	4	3/4"EK	1"F	645	82	210	1	1	<b>571,93</b>
<b>116711</b>	FD	11	4	3/4"EK	1"F	695	82	210	1	1	<b>625,36</b>
<b>116712</b>	FD	12	4	3/4"EK	1"F	745	82	210	1	1	<b>675,00</b>



## Collettore TEMPOWER 2G BASIC - 1 via aggiuntiva

Codice	Classe	N° vie	Portata	Attacchi utenze	Attacchi A caldaia	B	H	Minimo d'ordine	Imballo	Conf.	Euro
			l/min			mm	mm				pz
<b>116732</b>	FD	1	4	3/4" EK		50	80	210	1	104	1 <b>69,50</b>



## Collettore TEMPOWER 2G BASIC - 3 vie aggiuntive

Codice	Classe	N° vie	Portata	Attacchi utenze	Attacchi A caldaia	B	H	Minimo d'ordine	Imballo	Conf.	Euro
			l/min			mm	mm				pz
<b>116733</b>	FD	3	4	3/4" EK		50	80	210	1	48	1 <b>126,16</b>



## Collettore TEMPOWER 2G BASIC - Starter Pack

Codice	Classe	N° vie	Portata	Attacchi utenze	Attacchi A caldaia	B	H	Minimo d'ordine	Imballo	Conf.	Euro
			l/min			mm	mm				pz
<b>116736</b>	FD	Starter			1"F	145	80	210	1	20	1 <b>123,55</b>



### Coppia di valvole a sfera per collettore TEMPOWER

Codice	Classe	Attacchi utenze	Attacchi caldaia	Minimo Imballo d'ordine	Conf.	Euro	pz
<b>126600</b>	FD	1" M	1" F	1	1	<b>57,92</b>	

### Ricambi per collettori TEMPOWER 2G e BASIC

Codice	Classe	Descrizione	Minimo Imballo d'ordine	Conf.	Euro	pz
<b>R 116524</b>	FD	Corpo 1 via 6 l/min	1	1	<b>35,01</b>	
<b>R 116525</b>	FD	Corpo 3 vie 6 l/min	1	1	<b>90,37</b>	
<b>R 116526</b>	FD	Testata	1	1	<b>50,53</b>	
<b>R 116527</b>	FD	Tappo	1	1	<b>2,08</b>	
<b>R 116531</b>	FD	Termometro	1	1	<b>11,22</b>	
<b>R 116731</b>	FD	Termometro Basic	2	2	<b>9,51</b>	
<b>R 116591</b>	FD	Set 2 valvole di carico e scarico	1	1	<b>27,69</b>	
<b>R 116592</b>	FD	Set 12 supporti plastici per aggancio testina elettrotermica	1	1	<b>49,85</b>	
<b>R 116593</b>	FD	Set o-rings e guarnizioni, per collettore fino a 12 vie	1	1	<b>8,32</b>	
<b>R 116594</b>	FD	Set rivestimenti plastici per una via, sia mandata che ritorno	1	1	<b>11,07</b>	
<b>R 116595</b>	FD	Set 5 misuratori di portata 6 l/min, per mandata	1	1	<b>141,16</b>	
<b>R 116596</b>	FD	Set 5 misuratori di portata 4 l/min, per mandata	1	1	<b>132,83</b>	
<b>R 116596T</b>	FD	Chiave per montaggio/smontaggio misuratore di portata	1	1	<b>23,51</b>	
<b>R 116597</b>	FD	Vitone per testina elettrotermica, per ritorno	1	1	<b>19,25</b>	
<b>R 116598</b>	FD	Set 2 sfiati automatici 1/2"	1	1	<b>31,84</b>	
<b>R 116599</b>	FD	Staffa a scatto	10	10	<b>3,58</b>	

R Contattare il Customer Service per tempistiche sulla disponibilità.

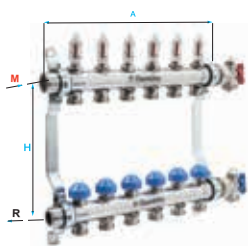
**Collettore INOX montato**

Codice	Classe	N° vie	Portata	Attacchi utenze	Attacchi A caldaia	B	H	Minimo d'ordine	Imballo	Conf.	Euro
			l/min			mm	mm				pz
<b>126702</b>	FD	2	6	3/4" EK	1" M	220	80	210	1	1	<b>240,43</b>
<b>126703</b>	FD	3	6	3/4" EK	1" M	270	80	210	1	1	<b>276,74</b>
<b>126704</b>	FD	4	6	3/4" EK	1" M	320	80	210	1	1	<b>312,80</b>
<b>126705</b>	FD	5	6	3/4" EK	1" M	370	80	210	1	1	<b>359,58</b>
<b>126706</b>	FD	6	6	3/4" EK	1" M	420	80	210	1	1	<b>408,97</b>
<b>126707</b>	FD	7	6	3/4" EK	1" M	470	80	210	1	1	<b>455,87</b>
<b>126708</b>	FD	8	6	3/4" EK	1" M	520	80	210	1	1	<b>500,98</b>
<b>126709</b>	FD	9	6	3/4" EK	1" M	570	80	210	1	1	<b>554,67</b>
<b>126710</b>	FD	10	6	3/4" EK	1" M	620	80	210	1	1	<b>611,44</b>
<b>126711</b>	FD	11	6	3/4" EK	1" M	670	80	210	1	1	<b>666,31</b>
<b>126712</b>	FD	12	6	3/4" EK	1" M	720	80	210	1	1	<b>717,97</b>

**Coppia di valvole a sfera per collettore Inox**

Codice	Classe	Attacchi utenze	Attacchi caldaia	Minimo d'ordine	Imballo	Conf.	Euro
							pz
<b>126700</b>	FD	1" F	1" F	1	1	1	<b>58,91</b>

**Termometro per valvola a sfera per collettore Inox**

Codice	Classe	Minimo d'ordine	Imballo	Conf.	Euro
					pz
<b>126701</b>	FD	1	1	1	<b>8,73</b>

**1 via aggiuntiva per collettore Inox**

Codice	Classe	N° vie	Portata	Attacchi utenze	Attacchi caldaia	Minimo d'ordine	Imballo	Conf.	Euro
			l/min						pz
<b>126720</b>	FD	1	6	3/4" EK	1" F	1	1	1	<b>145,93</b>



### Coppia di nippli per coll. Inox su gruppi miscelati

Codice	Classe	Attacchi utenze	Attacchi caldaia	Minimo d'ordine	Imballo	Conf.	Euro
<b>126721</b>	FD	1"F	1"F	1	20	1	<b>52,39</b>

pz



### Termometro a bracciale per coll. Inox

Codice	Classe	Ø collettore	Minimo d'ordine	Imballo	Conf.	Euro
<b>126723</b>	FD	1"	1		1	<b>7,16</b>

pz

### Ricambi per collettori INOX

Codice	Classe	Descrizione	Minimo d'ordine	Imballo	Conf.	Euro
<b>126724</b>	FD	Coppia terminali con sfiato	1		1	<b>85,62</b>
<b>126725</b>	FD	Misuratore di portata 6 l/min, per mandata	1		1	<b>15,85</b>
<b>R 126726</b>	FD	Vitone per testina elettrotermica, per ritorno	1		1	<b>10,85</b>
<b>R 126727</b>	FD	Manopola blu di apertura/chiusura, per ritorno	1		1	<b>0,39</b>

pz

**R** Contattare il Customer Service per tempistiche sulla disponibilità.

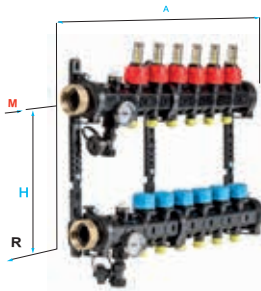
**Collettore PLASTICO 1"1/4 ad imballi - Starter pack**

Codice	Classe	N° vie	Portata	Attacchi utenze	Attacchi A caldaia	B	H	Minimo d'ordine	Imballo	Conf.	Euro
			l/min			mm	mm				pz
<b>R 126501T</b>	FD	6	5	Innesto	1" 1/4 F	441	95	210	1	1	<b>411,24</b>

**Collettore PLASTICO 1"1/4 ad imballi - 1 via aggiuntiva**

Codice	Classe	N° vie	Portata	Attacchi utenze	Attacchi A caldaia	B	H	Minimo d'ordine	Imballo	Conf.	Euro
			l/min			mm	mm				pz
<b>R 126502T</b>	FD	1	5	Innesto	1" 1/4 F	50	95	210	1	1	<b>43,42</b>

**Collettore PLASTICO 1"1/4 ad imballi - staffa telescopica aggiuntiva**

Codice	Classe	N° massimo di moduli tra staffe	A	B	H	Minimo d'ordine	Imballo	Conf.	Euro
			mm	mm	mm				pz
<b>R 126503T</b>	FD	4	-	95	210	1	1	<b>11,96</b>	

**Coppia di valvole a sfera per coll. Plastico 1"1/4**

Codice	Classe	N° vie	Attacchi utenze	Attacchi caldaia	Minimo d'ordine	Imballo	Conf.	Euro
								pz
<b>R 126500</b>	FD		1"1/4 F	1"1/4 F	1	1	<b>115,29</b>	

R Contattare il Customer Service per tempistiche sulla disponibilità.



### Raccordi adattatori ad innesto

Codice	Classe	Tubo	Attacchi collettore	Tipi di collettore	Ø	Minimo d'ordine	Imballo	Conf.	Euro
					mm				pz
<b>R 126525</b>	FD	Plastica	Innesto	Plas.1"1/4	25	2		2	<b>25,57</b>



### Raccordi 3/4" EK ad innesto

Codice	Classe	Tubo	Attacchi collettore	Tipi di collettore	Ø	Minimo d'ordine	Imballo	Conf.	Euro
					mm				pz
<b>R 126534</b>	FD	Tutti	Innesto	Plas.1"1/4	3/4" EK	2		2	<b>10,78</b>

### Ricambi per collettori Plastici 1"-1/4 Modulari

Codice	Classe	Descrizione	Minimo d'ordine	Imballo	Conf.	Euro
						pz
<b>R 126503T</b>	FD	Staffa telescopica	1		1	<b>11,96</b>
<b>R 126589</b>	FD	Modulo testata	1		1	<b>53,09</b>
<b>R 126590</b>	FD	Modulo terminale	1		1	<b>27,40</b>
<b>R 126591</b>	FD	Modulo accessori, con valvola carico e scarico, sfiato manuale, termometro	1		1	<b>114,39</b>
<b>R 126592</b>	FD	Valvola di carico e scarico 1/2"	1		1	<b>28,37</b>
<b>R 126593</b>	FD	Sfiato manuale 3/8"	1		1	<b>19,64</b>
<b>R 126594</b>	FD	Termometro	1		1	<b>37,08</b>
<b>R 126595</b>	FD	Misuratore di portata 5 l/min, per mandata	1		1	<b>32,31</b>
<b>R 126596</b>	FD	Vitone per testina elettrotermica, per ritorno	1		1	<b>24,41</b>

R Contattare il Customer Service per tempistiche sulla disponibilità.

**Testina elettrotermica BASIC**

Codice	Classe	Ten.	Micro	Attacchi collettore	Tipo di collettore	Minimo d'ordine	Imballo	Conf.	Euro
		V							pz
<b>106704</b>	FD	230	Si	30x1,5	Inox	1	50	1	<b>50,47</b>

**Testina elettrotermica**

Codice	Classe	Ten.	Micro	Attacchi collettore	Tipo di collettore	Minimo d'ordine	Imballo	Conf.	Euro
		V							pz
<b>106752</b>	FD	230	No	Innesto	Tempower	1	100	1	<b>46,65</b>
<b>106754</b>	FD	230	Si	Innesto	Tempower	1	100	1	<b>56,65</b>
<b>106762</b>	FD	24	No	Innesto	Tempower	1	100	1	<b>46,65</b>

**Adattatore per testine**

Codice	Classe	Mod.	Colore	Attacchi collettore	Tipo di collettore	Minimo d'ordine	Imballo	Conf.	Euro
									pz
<b>106718</b>	FD	VA10	Grigio chiaro	30x1,5	Plastico 1" 1/4" Temp. Basic	10		10	<b>2,36</b>
<b>106721</b>	FD	VA50	Grigio scuro	30x1,5	Inox	10		10	<b>2,36</b>

**Raccordi adattatori ad avvitamento**

Codice	Classe	Tubo	Attacchi collettore	Tipo di collettore	Ø	Minimo d'ordine	Imballo	Conf.	Euro
					mm				pz
<b>106614</b>	FD	Tutti	3/4"EK	Temp.-Inox	14x2,0	2		2	<b>5,15</b>
<b>73002</b>	FD	Tutti	3/4"EK	Temp.-Inox	16x2,0	2	300	2	<b>5,15</b>
<b>1066165</b>	FD	Plastico	3/4"EK	Temp.Inox	16x1,5	2	300	2	<b>5,15</b>
<b>106617</b>	FD	Tutti	3/4"EK	Temp.-Inox	17x2,0	2	300	2	<b>5,15</b>
<b>106618</b>	FD	Tutti	3/4"EK	Temp.-Inox	18x2,0	2		2	<b>5,15</b>
<b>106620</b>	FD	Tutti	3/4"EK	Temp.-Inox	20x2,0	2	300	2	<b>5,38</b>
<b>106622</b>	FD	Tutti	3/4"EK	Temp.-Inox	20x2,5	2		2	<b>7,59</b>



### Curva di sostegno per tubo

Codice	Classe	Ø tubo	Minimo Imballo d'ordine		Conf.	Euro
		mm				pz
<b>109018</b>	FD	16÷18	50	500	50	<b>1,82</b>
<b>109020</b>	FD	20÷23	20	100	20	<b>3,83</b>
<b>R 109025</b>	FD	25÷29	1	50	1	<b>6,90</b>



### Cassetta per collettore

Codice	Classe	a	h	A	B	H	Minimo Imballo d'ordine		Conf.	Euro
		mm	mm	mm	mm	mm				pz
<b>107145</b>	FD	600	660	540	93÷120	750÷890	1	24	1	<b>223,06</b>
<b>107147</b>	FD	760	660	700	93÷120	750÷890	1	12	1	<b>265,07</b>
<b>107148</b>	FD	910	660	850	93÷120	750÷890	1	12	1	<b>279,72</b>
<b>107149</b>	FD	1060	660	1000	93÷120	750÷890	1	12	1	<b>305,19</b>
<b>107151</b>	FD	1210	660	1150	93÷120	750÷890	1	12	1	<b>365,18</b>
<b>107153</b>	FD	1360	660	1300	93÷120	750÷890	1	6	1	<b>411,00</b>

### Ricambi per cassette per collettori

Codice	Classe	Descrizione	Minimo Imballo d'ordine		Conf.	Euro
						pz
<b>R 107145R</b>	FD	Cassetta 107145 - porta+cornice	1		1	<b>105,93</b>
<b>R 107147R</b>	FD	Cassetta 107147 - porta+cornice	1		1	<b>113,65</b>
<b>R 107148R</b>	FD	Cassetta 107148 - porta+cornice	1		1	<b>122,95</b>
<b>R 107149R</b>	FD	Cassetta 107149 - porta+cornice	1		1	<b>132,24</b>
<b>R 107151R</b>	FD	Cassetta 107151 - porta+cornice	1		1	<b>145,45</b>
<b>R 107153R</b>	FD	Cassetta 107153 - porta+cornice	1		1	<b>156,64</b>

R Contattare il Customer Service per tempistiche sulla disponibilità.



## Accoppiamenti cassette - collettori

Cassetta		Collettori Tempower - Basic ad imballi			Collettore Inox			Collettore plastico 1" 1/4 ad imballi			
	Lunghezza	n°vie	Lunghezza netta collettore	Lunghezza lorda collettore*	n°vie	Lunghezza netta collettore	Lunghezza lorda collettore*	n°vie	Lunghezza netta collettore	Lunghezza lorda collettore*	
	mm	-	mm	mm	-	mm	mm	-	mm	mm	
Standard	540	2-5	245-395	385-535	2-5	220-370	355-505	-	-	-	
	700	6-8	445-545	585-685	6-8	420-520	555-655	6-8	435-535	610-702	
	850	9-11	595-695	735-835	9-11	570-670	705-805	9-11	585-685	748-840	
	1000	12-14	745-845	885-985	12-14	720-820	855-955	12-14	735-835	886-978	
	1150	15-17	895-995	1035-1135	15-17	870-970	1005-1105	15-17	885-985	1024-1116	
Industriale	800	2-10	245-645	385-785	2-10	220-620	355-755	6-9	435-585	570-720	
	1200	11-17	695-995	835-1135	11-17	670-970	805-1105	10-17	635-985	770-1120	
(*) L'accoppiamento è calcolato considerando circa 140 mm di spazio tra il collettore più lungo e la dimensione della cassetta, di cui circa 70 mm impegnati dalle valvole a sfera.				(*) L'accoppiamento è calcolato considerando circa 135 mm di spazio tra il collettore più lungo e la dimensione della cassetta, di cui circa 70 mm impegnati dalle valvole a sfera.				(*) L'accoppiamento è calcolato considerando circa 135 mm di spazio tra il collettore più lungo e la dimensione della cassetta, di cui circa 110 mm impegnati dalle valvole a sfera.			

Cassetta		Collettore Tempower + Sistema Preassemblato Tempower senza/con sezione di alta temperatura		
	Lunghezza	n°vie	Lunghezza netta collettore + preassemblato	Lunghezza lorda collettore + preassemblato*
	mm	-	mm	mm
Standard	540	2-3	441-491	490-540
	700	4-6	541-641	590-690
	850	7-9	691-791	740-840
	1000	10-12	841-941	890-990
	1150	13-15	991-1091	1040-1140
	1300	16-17	1141-1191	1190-1240
	(*) L'accoppiamento è calcolato considerando circa 50 mm di spazio tra il collettore più lungo e la dimensione della cassetta. Lo spazio diventa da circa 25 mm utilizzando anche la sezione di alta temperatura.			

## Ricambi per articoli obsoleti



### Ricambi per collettori TEMPOWER 1G

Codice	Classe	Descrizione	Minimo d'ordine	Imballo	Conf.	Euro	pz
R 116524	FD	Corpo 1 via 6 l/min	1		1	<b>35,01</b>	
R 116525	FD	Corpo 3 vie 6 l/min	1		1	<b>90,37</b>	
R 116526	FD	Testata	1		1	<b>50,53</b>	
R 116527	FD	Tappo	1		1	<b>2,08</b>	
R 116531	FD	Termometro	1		1	<b>11,22</b>	
116580	FD	Set rivestimenti plastici per una via, sia mandata che ritorno	1		1	<b>esaurito</b>	
* 116584	FD	Vitone per testina elettrotermica, ritorno	1		1	<b>esaurito</b>	
** 116586	FD	Misuratore di portata 8 l/min, per mandata	1		1	<b>esaurito</b>	
116589	FD	Sfiato automatico 3/8"	1		1	<b>esaurito</b>	
116590	FD	Tappo rosso per sfiato automatico 3/8"	1		1	<b>esaurito</b>	
R 116591	FD	Set 2 valvole di carico e scarico	1		1	<b>27,69</b>	
R 116592	FD	Set 12 supporti plastici per aggancio testina elettrotermica	1		1	<b>49,85</b>	
R 116593	FD	Set o-rings e guarnizioni, per collettore fino a 12 vie	1		1	<b>8,32</b>	
R 116596	FD	Set 5 misuratori di portata 4 l/min, per mandata	1		1	<b>132,83</b>	
R 116597	FD	Vitone per testina elettrotermica, per ritorno	1		1	<b>19,25</b>	
R 116599	FD	Staffa a scatto	10		10	<b>3,58</b>	

\* Vecchio vitone del collettore Tempower 1G, al suo posto utilizzare il nuovo vitone 116597

\*\* Vecchio misuratore di portata del collettore Tempower 1G, al suo posto utilizzare 116596 (permette solo apertura/chiusura, no misurazione portata) oppure 116524/116525

### Ricambi per collettori Inoxterm



Codice	Classe	Descrizione	Minimo d'ordine	Imballo	Conf.	Euro	pz
106717	FD	Adattatore per testine elettrica VA80 bianco	10		10	<b>2,36</b>	
R 116600	FD	Misuratore di portata rosso 5 l/min, per mandata	1		1	<b>36,75</b>	
R 116601	FD	Codolo per misuratore da 5 l/min	1		1	<b>15,21</b>	
116600A	FD	Misuratore di portata nero 8 l/min, per ritorno	1		1	<b>esaurito</b>	
116601A	FD	Codolo per misuratore da 8 l/min	1		1	<b>esaurito</b>	
R 116613	FD	Vitone per testina elettrotermica	1		1	<b>20,90</b>	
R 116614	FD	Codolo per vitone per testina elettrotermica	1		1	<b>7,59</b>	
R 116615	FD	Manopola blu per vitone per testina elettrotermica	1		1	<b>esaurito</b>	
R 116616	FD	Manopola rossa per vitone per testina elettrotermica	1		1	<b>esaurito</b>	
R 116617	FD	Misuratore di portata 4 l/min, per ritorno	1		1	<b>esaurito</b>	
R 116618	FD	Codolo per misuratore di portata 4 l/min	1		1	<b>esaurito</b>	
R 126698	FD	Sfiato automatico	1		1	<b>30,53</b>	
R 126699	FD	Termometro	1		1	<b>33,00</b>	

R Contattare il Customer Service per tempistiche sulla disponibilità

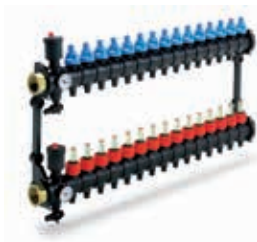

### Ricambi per collettori Plastici 1"-1/4 monoblocco

Codice	Classe	Descrizione	Minimo Imballo d'ordine	Conf.	Euro
					pz
<b>106718</b>	FD	Adattatore per testine elettriche VA10 grigio chiaro	10	10	<b>2,36</b>
<b>126503M</b>	FD	Modulo intermedio	1	1	<b>esaurito</b>
<b>126503S</b>	FD	Staffa singola	1	1	<b>esaurito</b>
<b>126594</b>	FD	Termometro	1	1	<b>37,08</b>
<b>126595</b>	FD	Misuratore di portata 5 l/min, per mandata	1	1	<b>32,31</b>
<b>126596</b>	FD	Vitone per testina elettrotermica, per ritorno	1	1	<b>24,41</b>
<b>126597</b>	FD	Valvola di carico e scarico 3/8"	1	1	<b>30,81</b>
<b>126598</b>	FD	Sfiato automatico 3/8"	1	1	<b>61,03</b>

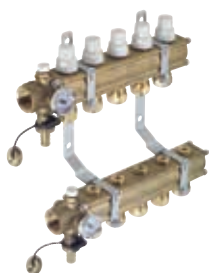

### Ricambi per collettori Combyterm

Codice	Classe	Descrizione	Minimo Imballo d'ordine	Conf.	Euro
					pz
<b>106104</b>	FD	Vitone per testina elettrotermica CALEFFI 69122 CST	1	1	<b>esaurito</b>
<b>106106</b>	FD	Detentore di taratura CALEFFI R69176	1	1	<b>esaurito</b>
<b>106719</b>	FD	Adattatore per testine elettriche VA90 rosso	1	1	<b>2,69</b>

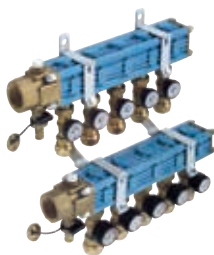

### Ricambi per collettori Polytrop

Codice	Classe	Descrizione	Minimo Imballo d'ordine	Conf.	Euro
					pz
<b>106716</b>	FD	Adattatore per testine elettriche VA19H grigio scuro	1	1	<b>5,19</b>

### Ricambi per cassette per collettori fino a 2013

Codice	Classe	Descrizione	Minimo Imballo d'ordine	Conf.	Euro
					pz
<b>R 107145CP</b>	FD	Cassetta 107145 2013 - porta+cornice	1	1	<b>222,46</b>
<b>R 107147CP</b>	FD	Cassetta 107147 2013 - porta+cornice	1	1	<b>241,27</b>
<b>R 107148CP</b>	FD	Cassetta 107148 2013 - porta+cornice	1	1	<b>251,27</b>
<b>R 107149CP</b>	FD	Cassetta 107149 2013 - porta+cornice	1	1	<b>284,48</b>
<b>R 107151CP</b>	FD	Cassetta 107151 2013 - porta+cornice	1	1	<b>328,39</b>
<b>R 107153CP</b>	FD	Cassetta 107153 2013 - porta+cornice	1	1	<b>334,11</b>

R Contattare il Customer Service per tempistiche sulla disponibilità

# Termoregolazioni

## Gruppo miscelato Tempower



### Gruppo miscelato Tempower - Sezione bassa temperatura classe A

Codice	Classe	Attacchi caldaia	Attacchi utenze	Minimo d'ordine	Imballo	Conf.	Euro
<b>107910A</b>	FD	1"F	1" M	1		1	<b>983,28</b>



### Coppia di nippoli per collettore Inox su gruppi miscelati

Codice	Classe	Attacchi caldaia	Attacchi utenze	Minimo d'ordine	Imballo	Conf.	Euro
<b>126721</b>	FD	1"F	1"F	1	20	1	<b>52,39</b>



### Gruppo miscelato Tempower - Sezione alta temperatura

Codice	Classe	Attacchi caldaia	Attacchi collettore	Minimo d'ordine	Imballo	Conf.	Euro
<b>107911</b>	FD	1"F	3/4"EK	1		1	<b>192,34</b>



### Adattatore per testine

Codice	Classe	Mod.	Colore	Attacchi gruppo mix	Tipo di gruppo mix	Minimo d'ordine	Imballo	Conf.	Euro
<b>106721</b>	FD	VA50	Grigio scuro	30x1,5	Sez. alta T. Tempower	10		10	<b>2,36</b>



### Servomotore

Codice	Classe	Mod.	Tensione	Attacchi gruppo mix	Minimo d'ordine	Imballo	Conf.	Euro
<b>107801</b>	FD	0-10V	24	30x1,5	1		1	<b>420,76</b>
<b>107802</b>	FD	3 punti	230	30x1,5	1		1	<b>420,76</b>



### Testa termostatica

Codice	Classe	Attacchi gruppo mix	Minimo Imballo d'ordine	Conf.	Euro
		mm			pz
<b>107803</b>	FD	30x1,5	1	1	<b>59,19</b>

### Ricambi per gruppi miscelati Tempower

Codice	Classe	Descrizione	Minimo Imballo d'ordine	Conf.	Euro
					pz
<b>R 107832</b>	FD	Circolatore Wilo Yonos Para RS25/6-130 attacchi 1-1/2"	1	1	<b>394,46</b>
<b>R 107989</b>	FD	Adattatore per staffa	1	1	<b>4,03</b>
<b>R 107990</b>	FD	Termometro, per sezione alta temperatura	1	1	<b>46,73</b>
<b>107991</b>	FD	Valvola di by-pass, per sezione alta temperatura	1	1	<b>24,74</b>
<b>107992</b>	FD	Detentore di taratura, per mandata sezione alta temperatura	1	1	<b>38,91</b>
<b>107993</b>	FD	Tappo arancione, per mandata sezione alta temperatura	1	1	<b>1,16</b>
<b>R 107994</b>	FD	Vitone per testina elettrotermica, per ritorno sezione alta temperatura	1	1	<b>33,28</b>
<b>R 107995</b>	FD	Tappo blu, per ritorno sezione alta temperatura	1	1	<b>1,16</b>
<b>107996</b>	FD	Corpo superiore, per sezione a bassa temperatura	1	1	<b>146,28</b>
<b>R 107997</b>	FD	Corpo inferiore, per sezione a bassa temperatura	1	1	<b>242,10</b>
<b>107998</b>	FD	Vitone per miscelatrice, per sezione a bassa temperatura	1	1	<b>73,96</b>
<b>R 107999</b>	FD	Valvola a sfera, per sezione a bassa temperatura	1	1	<b>66,58</b>
<b>R 108102</b>	FD	Termostato di sicurezza, per sezione a bassa temperatura	1	1	<b>55,51</b>
<b>R 116599</b>	FD	Staffa a scatto	10	10	<b>3,58</b>

**R** Contattare il Customer Service per tempistiche sulla disponibilità.

# Gruppi di regolazione da centrale termica\*



## Coppia di adattatori DN32 per collettore di distribuzione

Codice	Classe	Attacchi caldaia	Attacchi utenze	Minimo d'ordine	Imballo	Conf.	Euro
<b>117317</b>	FD	1"F	2"F	1		1	<b>41,76</b>

pz



## Staffe di fissaggio per separatori

Codice	Classe	Distanza dal muro	Minimo d'ordine	Imballo	Conf.	Euro
<b>117318</b>	FD	100	1		1	<b>85,92</b>

pz



## Staffe di fissaggio per gruppi DN25

Codice	Classe	Distanza dal muro	Attacchi caldaia	Attacchi utenze	Minimo d'ordine	Imballo	Conf.	Euro
<b>117320</b>	FD	100	1"1/2M	1"1/2F	1		1	<b>92,14</b>

pz



## Staffe di fissaggio per gruppi DN32

Codice	Classe	Distanza dal muro	Attacchi caldaia	Attacchi utenze	Minimo d'ordine	Imballo	Conf.	Euro
<b>117330</b>	FD	160	2"M	2"F	1		1	<b>121,14</b>

pz



### Separatori idraulici

Codice	Classe	Portata	Attacchi caldaia	Attacchi utenze	A	B	H	Minimo d'ordine	Imballo	Conf.	Euro
		m <sup>3</sup> /h			mm	mm	mm				pz
<b>117321</b>	FD	2	1" F	1" M	382	110	110	1	1	1	<b>401,96</b>
<b>R 117331</b>	FD	3	1"1/4 F	1"1/4 M	382	110	110	1	1	1	<b>409,10</b>



### Collettori di distribuzione

Codice	Classe	N° vie	Portata	Attacchi caldaia	Attacchi utenze	A	B	H	Minimo d'ordine	Imballo	Conf.	Euro
			m <sup>3</sup> /h			mm	mm	mm				pz
<b>117322</b>	FD	2	2	1" F	1" M	508	110	110	1	1	1	<b>541,70</b>
<b>117323</b>	FD	3	2	1" F	1" M	758	110	110	1	1	1	<b>622,27</b>
<b>R 117334</b>	FD	4	3	1"1/4 F	1" M	1008	110	110	1	1	1	<b>1.000,89</b>



### Gruppo di rilancio DN25

Codice	Classe	Circol.	Portata	Attacchi caldaia	Attacchi utenza	A	B	H	Minimo d'ordine	Imballo	Conf.	Euro
			m <sup>3</sup> /h			mm	mm	mm				pz
<b>117349</b>	FD	Wilo Para 25/6	2,15	1" F	1" M	250	380	170	1	1	1	<b>719,75</b>



### Gruppo di miscelazione termostatico DN25

Codice	Classe	Circol.	Portata	Attacchi caldaia	Attacchi utenza	A	B	H	Minimo d'ordine	Imballo	Conf.	Euro
			m <sup>3</sup> /h			mm	mm	mm				pz
<b>117348</b>	FD	Wilo Para 25/8	1,5	1" F	1" M	250	380	170	1	1	1	<b>11.192,65</b>

**R** Contattare il Customer Service per tempistiche sulla disponibilità.



### Gruppo di miscelazione DN25

Codice	Classe	Circol.	Portata	Attacchi caldaia	Attacchi A utenza	B	H	Minimo d'ordine	Imballo	Conf.	Euro
			m <sup>3</sup> /h			mm	mm				pz
<b>117347</b>	FD	Wilo Para 25/6	1,5	1" F	1" M	250	390	190	1	1	<b>870,79</b>



### Gruppo di miscelazione DN32

Codice	Classe	Circol.	Portata	Attacchi caldaia	Attacchi A utenza	B	H	Minimo d'ordine	Imballo	Conf.	Euro
			m <sup>3</sup> /h			mm	mm				pz
<b>117346</b>	FD	Wilo Para 30/8	2,8	1"1/4F	1"1/4F	250	410	250	1	1	<b>1.270,02</b>



### Servomotore Rotativo per gruppi di miscelazione

Codice	Classe	Mod.	Tensione	Attacchi gruppo mix	Coppia	Minimo d'ordine	Imballo	Conf.	Euro
			V		Nm				pz
<b>117390</b>	FD	0-10V	24	innesto	5	1	1	1	<b>344,82</b>



### Servomotore a punto fisso per gruppi di miscelazione

Codice	Classe	Mod.	Tensione	Attacchi gruppo mix	Coppia	Minimo d'ordine	Imballo	Conf.	Euro
			V		Nm				pz
<b>R 117341</b>	FD	0÷99°C	230	innesto	6	1	1	1	<b>484,20</b>

R Contattare il Customer Service per tempistiche sulla disponibilità.





### Sezione aggiuntiva di by-pass per DN25

Codice	Classe	Mod.	Attacchi utenza	Attacchi A pompa	B	H	Minimo d'ordine	Imballo	Conf.	Euro
										pz
					mm	mm	mm			
R <b>117342</b>	FD	DN25	1" F	1"-1/2F	125	120	80	1	1	<b>300,07</b>

### Ricambi per gruppi di regolazione da centrale termica

Codice	Classe	Descrizione	Minimo d'ordine	Imballo	Conf.	Euro
						pz
R <b>107833</b>	FD	Circolatore elettronico Wilo Para 25/6-180 attacchi 1-1/2"	1	1	1	<b>606,44</b>
R <b>107834</b>	FD	Circolatore elettronico Wilo Para 25/8-180 attacchi 1-1/2"	1	1	1	<b>671,67</b>
R <b>107835</b>	FD	Circolatore elettronico Wilo Para 30/7-180 attacchi 2"	1	1	1	<b>967,69</b>
<b>117390</b>	FD	Servomotore 24V 0-10V	1	1	1	<b>344,82</b>
R <b>117391</b>	FD	Servomotore 230V 3 punti	1	1	1	<b>344,82</b>
R <b>117392</b>	FD	Isolamento per DN25 dal 2015	1	1	1	<b>118,23</b>
R <b>117393</b>	FD	Isolamento per DN32 dal 2015	1	1	1	<b>147,95</b>
R <b>117394</b>	FD	Valvola termostatica per DN25	1	1	1	<b>396,12</b>
R <b>117395</b>	FD	Sezione a T per termostatica per DN25	1	1	1	<b>79,22</b>
R <b>117396</b>	FD	Valvola miscelatrice per DN25	1	1	1	<b>176,76</b>
R <b>117397</b>	FD	Sezione a T per miscelatrice per DN25	1	1	1	<b>79,96</b>

R Contattare il Customer Service per tempistiche sulla disponibilità.

# Ricambi per articoli obsoleti



## Ricambi per gruppi miscelati Inoxterm, codici 107800, 117800, 117810

Codice	Classe	Descrizione	Minimo d'ordine	Imballo	Conf.	Euro	pz
<b>107350</b>	FD	1 via aggiuntiva alta temperatura 1"F - 1"M	1	1	1	<b>esaurito</b>	
<b>107803INOX</b>	FD	Testa termostatica	1	1	1	<b>67,94</b>	
<b>R 107832</b>	FD	Circolatore Wilo Yonos Para RS25/6-130 attacchi 1-1/2"	1	1	1	<b>394,46</b>	
<b>107810</b>	FD	Due componenti sezione bassa temperatura	1	1	1	<b>esaurito</b>	
<b>R 107810S</b>	FD	Componente superiore sezione bassa temperatura	1	1	1	<b>324,82</b>	
<b>107810I</b>	FD	Componente inferiore sezione bassa temperatura	1	1	1	<b>esaurito</b>	
<b>R 107811</b>	FD	Pozzetto sonda termostatica	1	1	1	<b>42,41</b>	
<b>R 107812</b>	FD	Vitone valvola miscelatrice	1	1	1	<b>38,31</b>	
<b>R 107822</b>	FD	Sez. alta temp. By-pass destro (Senza v. a sfera)	1	1	1	<b>370,77</b>	
<b>R 107822S</b>	FD	Sez. alta temp. By-pass sinistro (Con v. a sfera)	1	1	1	<b>466,47</b>	
<b>R 107824</b>	FD	Valvola di by-pass	1	1	1	<b>62,29</b>	
<b>R 107825</b>	FD	Vitone per testina elettrotermica, per ritorno sezione alta temperatura	1	1	1	<b>37,69</b>	
<b>R 108101</b>	FD	Termostato di sicurezza	1	1	1	<b>42,08</b>	
<b>R 126601</b>	FD	Coppia valvole a sfera 1"-1"1/4	1	1	1	<b>esaurito</b>	



## Ricambi per kit in cassetta da 11 cm, codici 117302/.../12

Codice	Classe	Descrizione	Minimo d'ordine	Imballo	Conf.	Euro	pz
<b>107803INOX</b>	FD	Testa termostatica	1	1	1	<b>67,94</b>	
<b>R 107832</b>	FD	Circolatore Wilo Yonos Para RS25/6-130 attacchi 1-1/2"	1	1	1	<b>394,46</b>	
<b>R 107825</b>	FD	Vitone per testina elettrotermica e per miscelatrice	1	1	1	<b>37,69</b>	
<b>R 107826</b>	FD	Detentore di taratura	1	1	1	<b>35,70</b>	
<b>R 107827</b>	FD	Manopola vitone per testina	1	1	1	<b>29,81</b>	
<b>R 107828</b>	FD	Collettore Alta Temperatura	1	1	1	<b>126,16</b>	
<b>R 126601</b>	FD	Coppia valvole a sfera 1"-1"1/4	1	1	1	<b>esaurito</b>	

**R** Contattare il Customer Service per tempistiche sulla disponibilità



### Ricambi per Kit Family, codice 118102

Codice	Classe	Descrizione	Minimo Imballo d'ordine	Conf.	Euro
<b>107831</b>	FD	Circolatore elettronico Calpeda NCE EI 25-60/130	1	1	<b>esaurito</b>

pz



### Ricambi per gruppi di regolazione Chemidro a 2 vie, codice 107850

Codice	Classe	Descrizione	Minimo Imballo d'ordine	Conf.	Euro
<b>108301</b>	FD	Testa termostatica RT2 con sonda di mandata Reich	1	1	<b>esaurito</b>
* <b>108311</b>	FD	Valvola 3/4 per termostatica RT2 Reich	1	1	<b>210,20</b>

pz



### Ricambi per gruppi di regolazione Chemidro a 3 vie, codice 107600

Codice	Classe	Descrizione	Minimo Imballo d'ordine	Conf.	Euro
<b>106956</b>	FD	Valvola miscelatrice tre vie DN 20 Oventrop	1	1	<b>esaurito</b>
<b>106959</b>	FD	Testa termostatica con sonda di mandata Oventrop	1	1	<b>esaurito</b>

pz



### Ricambi per gruppi di regolazione Chemidro Zenit/Reklima, codici 107950/130010

Codice	Classe	Descrizione	Minimo Imballo d'ordine	Conf.	Euro
<b>106965</b>	FD	Valvola miscelatrice VXP459 20-4 Siemens	1	1	<b>esaurito</b>
<b>108050</b>	FD	Servomotore 230V 3 punti SSY319 Siemens	1	1	<b>esaurito</b>
<b>108055</b>	FD	Servomotore 24V 0-10V SSB61 Siemens	1	1	<b>esaurito</b>

pz

\* Ad esaurimento

## Attrezzature per sistemi radianti



### Kit montaggio tubo-raccordo

Codice	Classe	Ø	Minimo Imballo d'ordine	Conf.	Euro
		mm			pz
<b>95700</b>	SFA	10	1	1	<b>79,05</b>



### Attrezzo di supporto tubo per porte

Codice	Classe	Peso	Minimo Imballo d'ordine	Conf.	Euro
					pz
<b>4080342</b>	SFA	2,0	1	1	<b>397,42</b>



### Utensile Tacker fissa clip

Codice	Classe	Peso	Minimo d'ordine	Imballo	Conf.	Euro
		kg			pz	
<b>151010</b>	SFA	3,1	1	1		<b>566,60</b>



### Svolgitubo

Codice	Classe	Peso	Minimo d'ordine	Imballo	Conf.	Euro
		kg			pz	
<b>152001</b>	SFA	8,5	1	1		<b>482,55</b>



### Tagliatubo

Codice	Classe	Ø	Minimo d'ordine	Imballo	Conf.	Euro
		mm			pz	
<b>R 850002</b>	SFA	14-75	1	1		<b>120,85</b>



### Cesoia con fermatubo ferma tubo

Codice	Classe	Ø	Minimo d'ordine	Imballo	Conf.	Euro
		mm			pz	
<b>R 850200</b>	SFA	14-26	1	1		<b>152,04</b>

R Contattare il Customer Service per tempistiche sulla disponibilità.



### Impugnatura Kalispeed

Codice	Classe	Ø	Minimo d'ordine	Imballo	Conf.	Euro
		mm				pz
<b>897101</b>	SFA	14-32	1	1	1	<b>53,71</b>



### Calibratore interno-esterno per Kalispeed

Codice	Classe	Ø	Minimo d'ordine	Imballo	Conf.	Euro
		mm				pz
<b>897216</b>	SFA	16x2,0	1	1	1	<b>61,35</b>
<b>R 897317</b>	SFA	17x2,0	1	1	1	<b>61,35</b>
<b>R 897320</b>	SFA	20x2,0	1	1	1	<b>67,51</b>
<b>897220</b>	SFA	20x2,5	1	1	1	<b>67,51</b>



### Pressatrice elettrica

Codice	Classe	Mod.	Completa di valigetta in plastica	Tensione	Minimo d'ordine	Imballo	Conf.	Euro
				V				pz
<b>R 860018</b>	SFA	ACO203	si	18	1	1	1	<b>3.934,90</b>
<b>R 860230</b>	SFA	ECO203	si	230	1	1	1	<b>3.513,43</b>



### Ganasce Novopress

Codice	Classe	Mod.	Profilo	Ø	Minimo d'ordine	Imballo	Conf.	Euro
				mm				pz
<b>860216</b>	SFA	ACO203	CH	16	1	1	1	<b>422,54</b>
<b>860217</b>	SFA	ACO203	CH	17	1	1	1	<b>422,54</b>
<b>R 860221</b>	SFA	ACO203	U	20	1	1	1	<b>414,33</b>
<b>R 861121</b>	SFA	ACO103	U	20	1	1	1	<b>414,33</b>

**R** Contattare il Customer Service per tempistiche sulla disponibilità.

## Ricambi per Attrezzatura

Codice	Classe	Descrizione	Minimo Imballo d'ordine	Conf.	Euro
					pz
<b>R 151011</b>	SFA	Elemento a ghigliottina per Tacker 151010	1	1	<b>27,53</b>
<b>R 151012</b>	SFA	Molla per Tacker 151010	1	1	<b>27,53</b>
<b>R 151013</b>	SFA	Elemento di copertura con cerniere per Tacker 151010	1	1	<b>34,44</b>
<b>R 850001</b>	SFA	Lama ricambio per tagliatubo 14-63mm	1	1	<b>43,64</b>
<b>R 850003</b>	SFA	Lama ricambio per tagliatubo 14-75mm	1	1	<b>14,39</b>
<b>R 850201</b>	SFA	Lama di ricambio per cesoia con ferma tubo 14-26	1	1	<b>20,31</b>
<b>R 860019</b>	SFA	Batteria di riserva 3,0 AH per ACO 203	1	1	<b>971,11</b>
<b>R 860089</b>	SFA	Carica batteria 230V/18V per ACO 203	1	1	<b>345,27</b>

**R** Contattare il Customer Service per tempistiche sulla disponibilità.





# Ventilazione Meccanica Controllata



# Unità di deumidificazione e trattamento dell'aria

## DEUKLIMA



### Deumidificatori a parete

Codice	Classe	Mod.	Tipo	A	B	H	Minimo Imballo d'ordine	Conf.	Euro
				mm	mm	mm	pz		
<b>132010</b>	CFE	P300/2	Isotermico	678	550	217	1	1	<b>2.689,63</b>
<b>132110</b>	CFE	PC300/2	Con integrazione termica	678	550	217	1	1	<b>3.188,41</b>



### Dima di supporto per Deuklima P/2 - PC/2

Codice	Classe	A	B	H	Minimo Imballo d'ordine	Conf.	Euro
		mm	mm	mm	pz		
<b>132206</b>	CFE	720	585	223	1	1	<b>294,79</b>



### Pannello frontale per Deuklima P/2 - PC/2

Codice	Classe	A	B	H	Minimo Imballo d'ordine	Conf.	Euro
		mm	mm	mm	pz		
<b>132207</b>	CFE	745	610	20	1	1	<b>672,94</b>



### Deumidificatori da soffitto

Codice	Classe	Mod.	Tipo	A	B	H	Minimo Imballo d'ordine	Conf.	Euro
				mm	mm	mm	pz		
<b>132011</b>	CFE	S300/2	Isotermico	650	525	249	1	1	<b>2.689,63</b>
<b>132111</b>	CFE	SC300/2	Con integrazione termica	650	525	249	1	1	<b>3.142,42</b>
<b>R 132222</b>	CFE	SCRAE500	Con integrazione termica	780	580	315	1	1	<b>5.467,69</b>
<b>R 132223</b>	CFE	SCRAE1000	Con integrazione termica	805	600	350	1	1	<b>8.139,63</b>

**R** Contattare il Customer Service per tempistiche sulla disponibilità.



### Raccordo di mandata per S-SC300

Codice	Classe	Ø	A	B	H	Minimo Imballo d'ordine	Conf.	Euro
		mm	mm	mm	mm			pz
<b>132501</b>	CFE	160	320	180	59	1	1	<b>41,95</b>



### Raccordo di ripresa per S-SC300

Codice	Classe	Ø	A	B	H	Minimo Imballo d'ordine	Conf.	Euro
		mm	mm	mm	mm			pz
<b>132502</b>	CFE	160	350	185	59	1	1	<b>51,92</b>

### Filtri per unità di deumidificazione DEUKLIMA

	Codice	Classe	Descrizione	Minimo Imballo d'ordine	Conf.	Euro
						pz
R	<b>132921</b>	CFE	Filtro CFFC 500x165x10 per P300/2   PC300/2	1	1	<b>24,69</b>
R	<b>132922</b>	CFE	Filtro CFFC 365x200x10 per S300/2   SCx300/2   RK300	1	1	<b>24,69</b>
R	<b>132923</b>	CFE	Filtro CFOF 620x295x48 per SCR700   SCR1000	1	1	<b>33,29</b>
R	<b>132924</b>	CFE	Filtro CFOF 420x295x48 per RK700   RK1000	1	1	<b>45,28</b>
R	<b>132925</b>	CFE	Filtro CFFC 200x200x10 per RKA300	1	1	<b>30,59</b>
R	<b>132926</b>	CFE	Filtro CFOL 520x245x48 per SCRAE500	1	1	<b>46,47</b>
R	<b>132927</b>	CFE	Filtro CFOL 200x245x48 per RKA500	1	1	<b>45,13</b>

R Contattare il Customer Service per tempistiche sulla disponibilità.

# Unità di ventilazione decentralizzate

## VENTIZA SOLO



### VENTIZA SOLO 60A

Codice	Classe	Supporta/Include Telecomando	Portata	Foro muro	Profondità	Minimo d'ordine	Imballo	Conf.	Euro
			m <sup>3</sup> /h	mm	mm				pz
<b>140032A</b>	VMC	Si	60	160	250÷500	210	210	1	<b>723,74</b>

NOTA: l'acquisto di questi articoli e/o dei loro accessori non necessita né include interventi di primo avviamento

### VENTIZA SOLO 30A-2



Codice	Classe	Supporta/Include Telecomando	Portata	Foro muro	Profondità	Minimo d'ordine	Imballo	Conf.	Euro
			m <sup>3</sup> /h	mm	mm				pz
<b>4082837</b>	VMC	Si	30	100	250÷500	1		1	<b>730,00</b>

NOTA: l'acquisto di questi articoli e/o dei loro accessori non necessita né include interventi di primo avviamento

### VENTIZA SOLO 60A-2



Codice	Classe	Supporta/Include Telecomando	Portata	Foro muro	Profondità	Minimo d'ordine	Imballo	Conf.	Euro
			m <sup>3</sup> /h	mm	mm				pz
<b>4082836</b>	VMC	Si	60	160	250÷500	1		1	<b>760,00</b>

NOTA: l'acquisto di questi articoli e/o dei loro accessori non necessita né include interventi di primo avviamento



### VENTIZA SOLO 60B

Codice	Classe	Supporta/Include Telecomando	Portata	Foro muro	Profondità	Minimo d'ordine	Imballo	Conf.	Euro
			m <sup>3</sup> /h	mm	mm				pz
<b>4067997</b>	VMC	Si	60	160	250÷500	1		1	<b>817,38</b>

NOTA: l'acquisto di questi articoli e/o dei loro accessori non necessita né include interventi di primo avviamento



### Prolunga per unità VENTIZA SOLO

Codice	Classe	Unità	Spessore massimo del muro	L	Ø	Spes.	Minimo d'ordine	Imballo	Conf.	Euro
			mm	mm	mm	mm				pz
<b>NEW</b> R 4083059	VMC	30A-2	700	700	100	2	1	1	1	<b>32,96</b>
<b>140134</b>	VMC	60A   60A-2   60B	700	700	160	2	1	1	1	<b>32,96</b>



### Filtri per unità VENTIZA SOLO

Codice	Classe	Classe di filtrazione	Unità	N. pz. per macch.	Ø	Spessore	Minimo d'ordine	Imballo	Conf.	Euro
						mm				pz
<b>4083060</b>	VMC	antipolvere	30A-2	2	100	3	4	4	4	<b>5,66</b>
<b>R 140931</b>	VMC	antipolvere	60A   60A-2   60B	2	160	3	4	120	4	<b>5,66</b>
<b>140931B</b>	VMC	Coarse 45%	60A-2   60B	1	160		2		2	<b>56,61</b>



### Griglia esterna pieghevole per unità VENTIZA SOLO

Codice	Classe	Unità	Ø	Minimo d'ordine	Imballo	Conf.	Euro
			mm				pz
<b>NEW</b> <b>4083061</b>	VMC	60A 60A-2 60B	160	1	1	1	<b>60,00</b>



### Smorzatore acustico per unità VENTIZA SOLO

Codice	Classe	Unità	Ø	Minimo d'ordine	Imballo	Conf.	Euro
			mm				pz
<b>NEW</b> <b>4082749</b>	VMC	60A 60A-2 60B	160	1	1	1	<b>34,30</b>

### Ricambi per unità VENTIZA SOLO

Codice	Classe	Descrizione	Minimo d'ordine	Imballo	Conf.	Euro
						pz
<b>NEW</b> R 4083119	VMC	Tube L=500 mm per unità 30A-2	1	1	1	<b>30,00</b>
<b>NEW</b> R 4083116	VMC	Tube L=500 mm per unità 60A   60A-2   60B	1	1	1	<b>30,00</b>
<b>140932</b>	VMC	Telecomando per REK60   REK60A   60A	1	1	1	<b>96,60</b>
<b>4067998</b>	VMC	Telecomando per 30A-2   60A-2   REK60B   60B	1	1	1	<b>144,25</b>
<b>NEW</b> R 4083062	VMC	Unità ventilante per 30A-2	1	1	1	<b>360,00</b>
R 140938A	VMC	Unità ventilante per REK60A   60A	1	1	1	<b>697,18</b>
<b>NEW</b> R 4083063	VMC	Unità ventilante per 60A-2	1	1	1	<b>360,00</b>
R 140938B	VMC	Unità ventilante per REK60B   60B	1	1	1	<b>420,00</b>

R Contattare il Customer Service per tempistiche sulla disponibilità

# Unità di ventilazione residenziali VENTIZA HP



## VENTIZA HP REK1318 orizzontali/verticali/sul fianco

Codice	Classe	Modello	Install.	Recup.	Portata aria nominale	L	P	H	Minimo d'ordine	Imballo	Conf.	Euro
					m <sup>3</sup> /h	mm	mm	mm				pz
<b>3085182</b>	VMC	REK1318	Sof./Par.V//Par.O	Sensibile	180	1142	695	285	1		1	<b>3.882,82</b>
<b>3085184</b>	VMC	REK1318e	Sof./Par.V//Par.O	Entalpico	180	1142	695	285	1		1	<b>4.431,67</b>

NOTA: l'acquisto di questi articoli e/o dei loro accessori non necessita né include interventi di primo avviamento



## VENTIZA HP REK2028 orizzontali/verticali/sul fianco

Codice	Classe	Modello	Install.	Recup.	Portata aria nominale	L	P	H	Minimo d'ordine	Imballo	Conf.	Euro
					m <sup>3</sup> /h	mm	mm	mm				pz
<b>3085183</b>	VMC	REK2028	Sof./Par.V//Par.O	Sensibile	280	1142	695	285	1		1	<b>4.065,39</b>
<b>3085185</b>	VMC	REK2028e	Sof./Par.V//Par.O	Entalpico	280	1142	695	285	1		1	<b>4.694,76</b>

NOTA: l'acquisto di questi articoli e/o dei loro accessori non necessita né include interventi di primo avviamento



## Comando utente a muro per VENTIZA HP

Codice	Classe	Sensori inclusi	Alimentazione	Connessione	L	P	H	Minimo d'ordine	Imballo	Conf.	Euro
					mm	mm	mm				pz
<b>R* 4080195</b>	VMC	T+H	Dall'unità Ventiza HP	Cavo a 2 poli	89	21	113	1		1	<b>181,03</b>
<b>R** 3087907</b>	VMC	T	Dall'unità Ventiza HP	Cavo a 2 poli	89	21	113	1		1	<b>141,36</b>

\*4080195 necessita di una diversa configurazione delle unità Ventiza HP.

\*\*3087907 è un ricambio, essendo già incluso nelle unità di ventilazione VENTIZA HP



## Filtri per unità di ventilazione VENTIZA HP

Codice	Classe	Macch. rif.	N. pz. per macch.	Tipologia	L	P	H	Minimo d'ordine	Imballo	Conf.	Euro
					mm	mm	mm				pz
<b>3087908</b>	VMC	Ventiza HP	1 set di 3 filtri	2 x Coarse 60% 1 x ePM1 60%	265 250	232 232	20 35	1		1	<b>84,91</b>

R Contattare il Customer Service per tempistiche sulla disponibilità.

# Unità di ventilazione residenziali VENTIZA DUO



## VENTIZA DUO REK180L orizzontali/verticali

Codice	Classe	Modello	Install.	Recup.	Portata aria nominale	L	P	H	Minimo d'ordine	Imballo	Conf.	Euro
					m <sup>3</sup> /h	mm	mm	mm				pz
<b>4068056</b>	VMC	REK180L	Sof./Par.	Sensibile	180	900	580	268	1		1	<b>2.786,33</b>
<b>4068057</b>	VMC	REK180Le	Sof./Par.	Entalpico	180	900	580	268	1		1	<b>3.627,76</b>

NOTA: l'acquisto di questi articoli e/o dei loro accessori non necessita né include interventi di primo avviamento



## VENTIZA DUO REK180M orizzontali/verticali

Codice	Classe	Modello	Install.	Recup.	Portata aria nominale	L	P	H	Minimo d'ordine	Imballo	Conf.	Euro
					m <sup>3</sup> /h	mm	mm	mm				pz
<b>4080592</b>	VMC	REK180M	Sof./Par.	Sensibile	180	914	595	282	1		1	<b>3.810,47</b>
<b>4080593</b>	VMC	REK180Me	Sof./Par.	Entalpico	180	914	595	282	1		1	<b>4.348,98</b>

NOTA: l'acquisto di questi articoli e/o dei loro accessori non necessita né include interventi di primo avviamento



## VENTIZA DUO REK250L orizzontali/verticali

Codice	Classe	Modello	Install.	Recup.	Portata aria nominale	L	P	H	Minimo d'ordine	Imballo	Conf.	Euro
					m <sup>3</sup> /h	mm	mm	mm				pz
<b>4080060</b>	VMC	REK250L	Sof./Par.	Sensibile	250	1005	595	282	1		1	<b>3.334,46</b>
<b>4080061</b>	VMC	REK250Le	Sof./Par.	Entalpico	250	1005	595	282	1		1	<b>3.839,32</b>

NOTA: l'acquisto di questi articoli e/o dei loro accessori non necessita né include interventi di primo avviamento



## VENTIZA DUO REK250M orizzontali/verticali

Codice	Classe	Modello	Install.	Recup.	Portata aria nominale	L	P	H	Minimo d'ordine	Imballo	Conf.	Euro
					m <sup>3</sup> /h	mm	mm	mm				pz
<b>4080062</b>	VMC	REK250M	Sof./Par.	Sensibile	250	1005	595	282	1		1	<b>4.184,30</b>
<b>4080063</b>	VMC	REK250Me	Sof./Par.	Entalpico	250	1005	595	282	1		1	<b>4.831,00</b>

NOTA: l'acquisto di questi articoli e/o dei loro accessori non necessita né include interventi di primo avviamento



## VENTIZA DUO REK450L orizzontali/verticali

Codice	Classe	Modello	Install.	Recup.	Portata aria nominale	L	P	H	Minimo d'ordine	Imballo	Conf.	Euro
					m <sup>3</sup> /h	mm	mm	mm				pz
<b>4068058</b>	VMC	REK450L	Sof./Par.	Sensibile	450	1431	578	291	1		1	<b>4.561,75</b>

NOTA: l'acquisto di questi articoli e/o dei loro accessori non necessita né include interventi di primo avviamento

# Unità di ventilazione residenziali a basamento

## VENTIZA FLOOR



### REK250 basamento

Codice	Classe	Modello	Install.	Recup.	Portata aria nominale	L	P	H	Minimo d'ordine	Imballo	Conf.	Euro
					m <sup>3</sup> /h	mm	mm	mm				pz
<b>140022</b>	VMC	REK250	Basam.	Sensibile	220	600	403	684	1	1		<b>3.996,78</b>
<b>R 140024</b>	VMC	REK250E	Basam.	Entalpico	220	600	403	684	1	1		<b>5.672,43</b>

NOTA: l'acquisto di questi articoli e/o dei loro accessori non necessita né include interventi di primo avviamento



### REK370 basamento

Codice	Classe	Modello	Install.	Recup.	Portata aria nominale	L	P	H	Minimo d'ordine	Imballo	Conf.	Euro
					m <sup>3</sup> /h	mm	mm	mm				pz
<b>140023</b>	VMC	REK370	Basam.	Sensibile	370	710	624	684	1	1		<b>4.719,20</b>
<b>140025</b>	VMC	REK370E	Basam.	Entalpico	370	710	624	684	1	1		<b>5.987,36</b>

NOTA: l'acquisto di questi articoli e/o dei loro accessori non necessita né include interventi di primo avviamento

R Contattare il Customer Service per tempistiche sulla disponibilità





### Comando utente a 4 modalità con sensore di umidità per REK wireless

Codice	Classe	Alimentazione	Connessione	L	P	H	Minimo Imballo d'ordine	Conf.	Euro
				mm	mm	mm			
<b>140111</b>	VMC	Batterie 2xAA	Wireless	100	25	100	1	1	<b>355,93</b>



### Comando utente a 4 modalità con sensore di CO<sub>2</sub> per REK wireless

Codice	Classe	Alimentazione	Connessione	L	P	H	Minimo Imballo d'ordine	Conf.	Euro
				mm	mm	mm			
<b>R 140112</b>	VMC	230V	Wireless	100	25	100	1	1	<b>749,35</b>



### Comando utente a 4 modalità con display per REK wireless

Codice	Classe	Alimentazione	Connessione	L	P	H	Minimo Imballo d'ordine	Conf.	Euro
				mm	mm	mm			
<b>R 140116</b>	VMC	230V	Wireless	55	35	55	1	1	<b>405,80</b>



### Ricambi per REK wireless

Codice	Classe	Descrizione	Macchina riferimento	Minimo Imballo d'ordine	Conf.	Euro
<b>140910</b>	VMC	Comando a 4 funzioni	REK Wifi	1	1	<b>216,36</b>
<b>140921</b>	VMC	Antenna	REK Wifi	1	1	<b>56,47</b>

**R** Contattare il Customer Service per tempistiche sulla disponibilità



### Filtri F7 (ePM<sub>2,5</sub> 65%) per unità di ventilazione meccanica RDCD e REK

Codice	Classe	Macch. rif.	N. pz. per macch.	L	P	H	Minimo d'ordine	Imballo	Conf.	Euro
				mm	mm	mm				pz
<b>140901</b>	VMC	RDCD 2.5	1	241	228	48	1	1	1	<b>94,56</b>
<b>140919</b>	VMC	RDCD 2.5 H	1	198	215	48	1	1	1	<b>73,04</b>
<b>140901</b>	VMC	RDCD 2.5 BP	1	241	228	48	1	1	1	<b>94,56</b>
<b>140901</b>	VMC	RDCD 2.5 H BP	1	241	228	48	1	1	1	<b>94,56</b>
<b>140901</b>	VMC	REK140 - RDCD 2.5	1	241	228	48	1	1	1	<b>94,56</b>
<b>140905</b>	VMC	RDCD 1.5	1	241	228	48	1	1	1	<b>99,33</b>
<b>140905</b>	VMC	RDCD 1.5 BP	1	241	228	48	1	1	1	<b>99,33</b>
<b>140907</b>	VMC	RDCD 3.5	1	241	254	48	1	1	1	<b>109,12</b>
<b>140907</b>	VMC	RDCD 3.5 BP	1	241	254	48	1	1	1	<b>109,12</b>
<b>140919</b>	VMC	REK160L-160Le	1	198	215	48	1	1	1	<b>73,04</b>
<b>140919</b>	VMC	REK180L-Le-M-Me	1	198	215	48	1	1	1	<b>73,04</b>
<b>140919</b>	VMC	REK250L-Le-M-Me	1	198	215	48	1	1	1	<b>73,04</b>
<b>140905</b>	VMC	REK160 BASIC	1	241	228	48	1	1	1	<b>99,32</b>
<b>140905</b>	VMC	REK160-160E	1	241	228	48	1	1	1	<b>99,32</b>
<b>140905</b>	VMC	REK160A-160AE	1	241	228	48	1	1	1	<b>99,32</b>
<b>140907</b>	VMC	REK280-280E	1	241	254	48	1	1	1	<b>109,12</b>
<b>140907</b>	VMC	REK280A-280AE	1	241	254	48	1	1	1	<b>109,12</b>
<b>R 140917</b>	VMC	REK470	1	241	442	48	1	1	1	<b>167,44</b>
<b>R 140929</b>	VMC	REK450L	1	240	202	48	1	1	1	<b>125,25</b>
<b>R 140915</b>	VMC	REK250-250E	1	364	148	30	1	1	1	<b>262,65</b>
<b>R 140911</b>	VMC	REK370-370E	1	608	225	40	1	1	1	<b>282,00</b>

**R** Contattare il Customer Service per tempistiche sulla disponibilità



### Coppia di Filtri G4 (ePM<sub>10</sub> 50%) per unità di ventilazione meccanica RDCD e REK

Codice	Classe	Macch. rif.	N. pz. per macch.	L mm	P mm	H mm	Minimo Imballo d'ordine	Conf.	Euro
<b>140902</b>	VMC	RDCD 2.5	1	241	228	23	1	1	<b>94,89</b>
<b>R 140900</b>	VMC	RDCD 2.5 H	1	198	215	23	1	1	<b>87,86</b>
<b>140902</b>	VMC	RDCD 2.5 BP	1	241	228	23	1	1	<b>94,89</b>
<b>140902</b>	VMC	RDCD 2.5 H BP	1	241	228	23	1	1	<b>94,89</b>
<b>140902</b>	VMC	REK140 - RDCD 2.5	1	241	228	23	1	1	<b>94,89</b>
<b>140906</b>	VMC	RDCD 1.5	1	241	228	23	1	1	<b>57,33</b>
<b>140906</b>	VMC	RDCD 1.5 BP	1	241	228	23	1	1	<b>57,33</b>
<b>140908</b>	VMC	RDCD 3.5	1	241	254	23	1	1	<b>71,61</b>
<b>140908</b>	VMC	RDCD 3.5 BP	1	241	254	23	1	1	<b>71,61</b>
<b>R 140909</b>	VMC	RDCD-O 450 EC	1	200	310	48	1	1	<b>57,34</b>
<b>140920</b>	VMC	REK160L-LE	1	198	215	23	1	1	<b>99,68</b>
<b>140920</b>	VMC	REK180L-Le-M-Me	1	198	215	23	1	1	<b>99,68</b>
<b>140920</b>	VMC	REK250L-Le-M-Me	1	198	215	23	1	1	<b>99,68</b>
<b>140906</b>	VMC	REK160 BASIC	1	241	226	23	1	1	<b>57,34</b>
<b>140906</b>	VMC	REK160-160E	1	241	226	23	1	1	<b>57,34</b>
<b>140906</b>	VMC	REK160A-160AE	1	241	226	23	1	1	<b>57,34</b>
<b>140908</b>	VMC	REK280-280E	1	241	228	23	1	1	<b>71,61</b>
<b>140908</b>	VMC	REK280A-280AE	1	241	228	23	1	1	<b>71,61</b>
<b>R 140918</b>	VMC	REK470	1	241	442	23	1	1	<b>109,61</b>
<b>R 140928</b>	VMC	REK450L	1	240	202	23	1	1	<b>109,59</b>
<b>R 140916</b>	VMC	REK250-250E	1	364	148	6	1	1	<b>147,74</b>
<b>R 140912</b>	VMC	REK370-370E	1	608	225	6	1	1	<b>147,74</b>



### Recuperatori entalpici per unità di ventilazione meccanica REK

Codice	Classe	Modello	Macchina riferimento	Minimo Imballo d'ordine	Conf.	Euro
<b>R 140952</b>	VMC	Entalpico	REK160L	1	1	<b>1.014,28</b>
<b>R 140953</b>	VMC	Entalpico	REK160	1	1	<b>936,03</b>
<b>R 140953</b>	VMC	Entalpico	REK160A	1	1	<b>936,03</b>
<b>R 140954</b>	VMC	Entalpico	REK280	1	1	<b>1.139,89</b>
<b>R 140954</b>	VMC	Entalpico	REK280A	1	1	<b>1.139,89</b>
<b>R 140955</b>	VMC	Entalpico	REK250	1	1	<b>2.401,68</b>
<b>R 140956</b>	VMC	Entalpico	REK370	1	1	<b>2.947,40</b>

**R** Contattare il Customer Service per tempistiche sulla disponibilità

# Unità di ventilazione residenziali ad incasso VENTIZA IN



## Unità verticali ad incasso VENTIZA IN (controllori inclusi)

Codice	Classe	Mod.	Install.	Scamb.	Portata aria nominale	L	P	H	Minimo d'ordine	Imballo	Conf.	Euro
					m <sup>3</sup> /h	mm	mm	mm				pz
<b>140051</b>	VMC	UV3-150P	Parete	Entalpico	150	425	224	723	1		1	<b>3.961,92</b>
<b>R140052</b>	VMC	UVE-150P	Parete	Entalpico	150	425	224	723	10		1	<b>4.511,25</b>



14 00 51



14 00 52

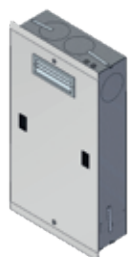

## Controcassa per unità verticali ad incasso

Codice	Classe	a	h	L	P	H	Minimo d'ordine	Imballo	Conf.	Euro	
			mm	mm	mm	mm	mm				pz
<b>140050</b>	VMC		695	1249	645	255	1189	1	1	<b>1.183,77</b>	



## Filtri F7 per unità di ventilazione meccanica UVx-150P

Codice	Classe	Classe ISO 16890	Macchina riferimento	N. pz. per macch.	L	P	H	Minimo d'ordine	Imballo	Conf.	Euro
					mm	mm	mm				pz
<b>141910</b>	VMC	ePM1 70%	UVx-150P	2	175	205	25	1		1	<b>38,48</b>



## Ricambi per unità di ventilazione UVx-150P

Codice	Classe	Descrizione	Macchina riferimento	N. pz. per macch.	Sensori inclusi	Minimo d'ordine	Imballo	Conf.	Euro
									pz
<b>R 141921</b>	VMC	Comando utente	UV3-150P	1	-	1		1	<b>195,09</b>
<b>R 141929</b>	VMC	Comando utente	UVE-150P	1	Temp.+UR	1		1	<b>856,94</b>
<b>R 140059</b>	VMC	Portella per controcassa per unità verticali ad incasso		1	-	1		-	<b>354,48</b>

R Contattare il Customer Service per tempistiche sulla disponibilità

# Unità di ventilazione residenziali a soffitto a basso spessore



## UV3 orizzontale

Codice	Classe	Mod.	Install.	Scamb.	Portata aria nominale	L	P	H	Minimo d'ordine	Imballo	Conf.	Euro
					m <sup>3</sup> /h	mm	mm	mm				pz
<b>140012</b>	VMC	UV3-510S	Soffitto	Termico	510	1100	720	275	1		1	<b>5.266,14</b>

NOTA: l'acquisto di questi articoli e/o dei loro accessori non necessita né include interventi di primo avviamento



## Filtri F7 per unità di ventilazione meccanica UV3

Codice	Classe	Classe ISO 16890	Macchina riferimento	N. pz. per macch.	L	P	H	Minimo d'ordine	Imballo	Conf.	Euro
					mm	mm	mm				pz
<b>R 141909</b>	VMC	ePM1 70%	UV3-510S	2	345	235	25	1		1	<b>67,91</b>



## Ricambi per unità di ventilazione UV3

Codice	Classe	Descrizione	Macchina riferimento	N. pz. per macch.	Sensori inclusi	Minimo d'ordine	Imballo	Conf.	Euro
									pz
<b>R 141921</b>	VMC	Comando utente	UV3-510S	1	-	1		1	<b>195,09</b>

R Contattare il Customer Service per tempistiche sulla disponibilità

# Unità di ventilazione non residenziali efficienza 90%

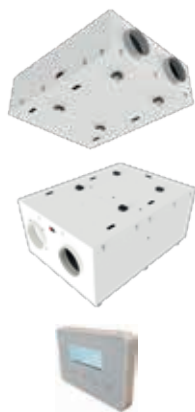

## UVNE orizzontali

Codice	Classe	Mod.	Inst.	Scamb.	Portata aria nominale	L	P	H	Minimo d'ordine	Imballo	Conf.	Euro
					m <sup>3</sup> /h	mm	mm	mm				pz
<b>R 140073</b>	VMC	UVNE-900S	Soffitto	Termico	900	1300	1040	420	1	1		<b>9.648,78</b>
<b>R 140074</b>	VMC	UVNE-1200S	Soffitto	Termico	1200	1500	1230	420	1	1		<b>12.368,99</b>
<b>R 140075</b>	VMC	UVNE-1550B	Basam.	Termico	1550	1600	1200	700	1	1		<b>14.568,73</b>
<b>R 140076</b>	VMC	UVNE-1800B	Basam.	Termico	1800	1700	1070	690	1	1		<b>17.357,46</b>

NOTA: l'acquisto di questi articoli e/o dei loro accessori non necessita né include interventi di primo avviamento

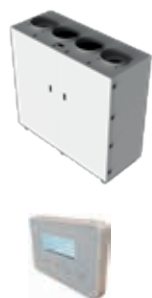

## UVNE verticali

Codice	Classe	Mod.	Install.	Scamb.	Portata aria nominale	L	P	H	Minimo d'ordine	Imballo	Conf.	Euro
					m <sup>3</sup> /h	mm	mm	mm				pz
<b>R 140083</b>	VMC	UVNE-900V	Basam.	Termico	900	1350	416	1100	1	1		<b>10.082,71</b>
<b>R 140084</b>	VMC	UVNE-1100V	Basam.	Termico	1100	1500	420	1200	1	1		<b>12.825,77</b>
<b>R 140085</b>	VMC	UVNE-1550V	Basam.	Termico	1550	1550	630	1400	1	1		<b>14.809,14</b>
<b>R 140086</b>	VMC	UVNE-1800V	Basam.	Termico	1800	1750	690	1400	1	1		<b>17.874,34</b>

NOTA: l'acquisto di questi articoli e/o dei loro accessori non necessita né include interventi di primo avviamento

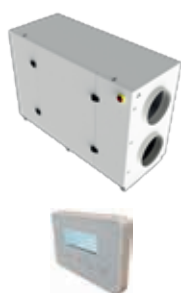

## UVNE a parete

Codice	Classe	Mod.	Install.	Scamb.	Portata aria nominale	L	P	H	Minimo d'ordine	Imballo	Conf.	Euro
					m <sup>3</sup> /h	mm	mm	mm				pz
<b>R 140087</b>	VMC	UVNE-2500P	Basam.	Termico	2500	1900	780	1250	1	1		<b>22.237,74</b>

NOTA: l'acquisto di questi articoli e/o dei loro accessori non necessita né include interventi di primo avviamento

## Controllo portata costante

Codice	Classe	Macchina riferimento	Portata aria nominale	Minimo d'ordine	Imballo	Conf.	Euro
			m <sup>3</sup> /h				pz
<b>R 140128</b>	VMC	UVNE-xxxxx	0÷2500	1	1		<b>866,07</b>

NOTA: articolo incluso all'interno della macchina di riferimento, il suo acquisto deve essere contemporaneo all'ordine della macchina stessa



### Filtri F7 per unità di ventilazione meccanica UVNE

Codice	Classe	Classe ISO 16890	Macchina riferimento	N. pz. per macch.	L	P	H	Minimo d'ordine	Imballo	Conf.	Euro
					mm	mm	mm				pz
R 141907	VMC	ePM1 70%	UVNE-900S	1	550	370	48	1	1	1	<b>156,39</b>
R 141907	VMC	ePM1 70%	UVNE-1200S	1	550	370	48	1	1	1	<b>156,39</b>
R 141913	VMC	ePM1 70%	UVNE-1550B	1	500	490	48	1	1	1	<b>215,04</b>
R 141903	VMC	ePM1 70%	UVNE-1800B	1	600	450	48	1	1	1	<b>190,28</b>
R 141911	VMC	ePM1 70%	UVNE-900V	1	370	370	48	1	1	1	<b>203,50</b>
R 141911	VMC	ePM1 70%	UVNE-1100V	1	370	370	48	1	1	1	<b>203,50</b>
R 141907	VMC	ePM1 70%	UVNE-1550V	1	550	370	48	1	1	1	<b>156,39</b>
R 141903	VMC	ePM1 70%	UVNE-1800V	1	600	450	48	1	1	1	<b>190,28</b>
R 141915	VMC	ePM1 70%	UVNE-2500P	1	700	470	48	1	1	1	<b>308,08</b>



### Filtri M5 per unità di ventilazione meccanica UVNE

Codice	Classe	Classe ISO 16890	Macchina riferimento	N. pz. per macch.	L	P	H	Minimo d'ordine	Imballo	Conf.	Euro
					mm	mm	mm				pz
R 141908	VMC	ePM10 50%	UVNE-900S	1	550	370	48	1	1	1	<b>124,53</b>
R 141908	VMC	ePM10 50%	UVNE-1200S	1	550	370	48	1	1	1	<b>124,53</b>
R 141914	VMC	ePM10 50%	UVNE-1550B	1	500	490	48	1	1	1	<b>142,68</b>
R 141904	VMC	ePM10 50%	UVNE-1800B	1	600	450	48	1	1	1	<b>151,69</b>
R 141912	VMC	ePM10 50%	UVNE-900V	1	370	370	48	1	1	1	<b>142,68</b>
R 141912	VMC	ePM10 50%	UVNE-1100V	1	370	370	48	1	1	1	<b>142,68</b>
R 141908	VMC	ePM10 50%	UVNE-1550V	1	550	370	48	1	1	1	<b>124,53</b>
R 141904	VMC	ePM10 50%	UVNE-1800V	1	600	450	48	1	1	1	<b>151,69</b>
R 141916	VMC	ePM10 50%	UVNE-2500P	1	700	470	48	1	1	1	<b>140,28</b>



### Ricambi per unità di ventilazione UVNE

Codice	Classe	Descrizione	Macchina riferimento	N. pz. per macch.	Sensori inclusi	Minimo d'ordine	Imballo	Conf.	Euro
									pz
141929	VMC	Comando utente bianco	UVNE	1	Temp.+UR	1	1	1	<b>856,94</b>

R Contattare il Customer Service per tempistiche sulla disponibilità

# Unità di ventilazione non residenziali efficienza 80%



## UVN8A orizzontali con by-pass motorizzato

Codice	Classe	Mod.	Inst.	Scamb.	Portata aria nominale	L	P	H	Minimo d'ordine	Imballo	Conf.	Euro
					m <sup>3</sup> /h	mm	mm	mm			pz	
R 140063	VMC	UVN8A-660S	Soff.	Termico	660	1350	970	410	1		1	<b>6.683,58</b>
				80%								
R 140064	VMC	UVN8A-1000S	Soff.	Termico	1000	1500	1100	520	1		1	<b>9.189,83</b>
				80%								
R 140065	VMC	UVN8A-1400S	Soff.	Termico	1400	1500	1100	600	1		1	<b>9.723,54</b>
				80%								
R 140066	VMC	UVN8A-1650S	Soff.	Termico	1650	1600	1250	620	1		1	<b>10.783,74</b>
				80%								
R 140067	VMC	UVN8A-2300S	Soff.	Termico	2300	1800	1250	800	1		1	<b>12.728,64</b>
				80%								
R 140068	VMC	UVN8A-3000S	Soff.	Termico	3000	1800	1250	1050	1		1	<b>14.339,37</b>
				80%								
R 140069	VMC	UVN8A-3500S	Soff.	Termico	3500	1800	1250	1350	1		1	<b>18.282,06</b>
				80%								

NOTA: l'acquisto di questi articoli e/o dei loro accessori non necessita né include interventi di primo avviamento

## Commutatore di velocità per UVN8A

Codice	Classe	Numero di velocità	Connessione all'unità	Macchina riferimento	Minimo d'ordine	Imballo	Conf.	Euro
								pz
R 140121	VMC	4	Via cavo	14 00 63	1		1	<b>106,97</b>
R 140122	VMC	3	Via cavo	14 00 64	1		1	<b>106,97</b>
				14 00 65				
				14 00 66				
				14 00 67				
				14 00 68				
R 140123	VMC	2	Via cavo	14 00 69	1		1	<b>147,85</b>

R Contattare il Customer Service per tempistiche sulla disponibilità





### Filtri F7 per unità di ventilazione meccanica UVN8A

Codice	Classe	Classe ISO 16890	Macchina riferimento	N. pz. per macch.	L	P	H	Minimo d'ordine	Imballo	Conf.	Euro
					mm	mm	mm				
<b>R 141901</b>	VMC	ePM1 70%	UVN8A-660S	1	470	350	48	1	1	1	<b>149,42</b>
<b>R 141903</b>	VMC	ePM1 70%	UVN8A-1000S	1	600	450	48	1	1	1	<b>190,28</b>
<b>R 141905</b>	VMC	ePM1 70%	UVN8A-1400S	1	625	500	48	1	1	1	<b>240,05</b>
<b>R 141905</b>	VMC	ePM1 70%	UVN8A-1650S	1	625	500	48	1	1	1	<b>240,05</b>
<b>R 141907</b>	VMC	ePM1 70%	UVN8A-2300S	2	550	370	48	1	1	1	<b>156,39</b>
<b>R 141903</b>	VMC	ePM1 70%	UVN8A-3000S	2	600	450	48	1	1	1	<b>190,28</b>
<b>R 141905</b>	VMC	ePM1 70%	UVN8A-3500S	2	625	500	48	1	1	1	<b>240,05</b>



### Filtri M5 per unità di ventilazione meccanica UVN8A

Codice	Classe	Classe ISO 16890	Macchina riferimento	N. pz. per macch.	L	P	H	Minimo d'ordine	Imballo	Conf.	Euro
					mm	mm	mm				
<b>R 141902</b>	VMC	ePM10 50%	UVN8A-660S	1	470	350	48	1	1	1	<b>119,98</b>
<b>R 141904</b>	VMC	ePM10 50%	UVN8A-1000S	1	600	450	48	1	1	1	<b>151,69</b>
<b>R 141906</b>	VMC	ePM10 50%	UVN8A-1400S	1	625	500	48	1	1	1	<b>194,73</b>
<b>R 141906</b>	VMC	ePM10 50%	UVN8A-1650S	1	625	500	48	1	1	1	<b>194,73</b>
<b>R 141908</b>	VMC	ePM10 50%	UVN8A-2300S	2	550	370	48	1	1	1	<b>124,53</b>
<b>R 141904</b>	VMC	ePM10 50%	UVN8A-3000S	2	600	450	48	1	1	1	<b>151,69</b>
<b>R 141906</b>	VMC	ePM10 50%	UVN8A-3500S	2	625	500	48	1	1	1	<b>194,73</b>

R Contattare il Customer Service per tempistiche sulla disponibilità

# Unità di ventilazione non residenziale centralizzata

## VENTIZA EDU adatta in ambito scolastico

\* Il numero d'ordine può essere raggiunto combinando i diversi codici



### VENTIZA EDU 400S orizzontali



	Codice	Classe	Modello	Inst.	Scambiatore	Portata L aria nomin.	L	P	H	* Minimo d'ordine	Imballo	Conf.	Euro
						m <sup>3</sup> /h	mm	mm	mm				pz
R	<b>140015</b>	VMC	UV3-400S	Soffitto	Termico	400	1020	1350	335	6	3	1	<b>7.471,88</b>
R	<b>140016</b>	VMC	UVE-400S	Soffitto	Termico	400	1020	1350	335	6	3	1	<b>8.433,52</b>



### VENTIZA EDU 920S orizzontali



	Codice	Classe	Modello	Inst.	Scambiatore	Portata L aria nomin.	L	P	H	* Minimo d'ordine	Imballo	Conf.	Euro
						m <sup>3</sup> /h	mm	mm	mm				pz
R	<b>140017</b>	VMC	UV3-920S+	Soffitto	Termico	920	1555	1355	470	6	3	1	<b>9.154,74</b>
R	<b>140018</b>	VMC	UVE-920S	Soffitto	Termico	920	1555	1355	470	6	3	1	<b>10.056,27</b>

### Lampada UV per Ventiza EDU

	Codice	Classe	Macchina di riferimento	Numeri di pezzi per macchina	Minimo d'ordine	Imballo	Conf.	Euro
								pz
R	<b>140139</b>	VMC	UVx-400S	1	1	1	1	<b>432,74</b>
R	<b>140140</b>	VMC	UVx-920S	1	1	1	1	<b>432,74</b>

NOTA: articolo incluso all'interno della macchina di riferimento, il suo acquisto deve essere contemporaneo all'ordine della macchina stessa



### Ventiza EDU con resistenza elettrica di post riscaldamento

	Codice	Classe	Macchina di riferimento	Potenza kW	* Minimo d'ordine	Imballo	Conf.	Euro
								pz
R	<b>140141</b>	VMC	UVE-400S	1,0	6	3	1	<b>9.753,36</b>
R	<b>140142</b>	VMC	UVE-920S	2,0	6	3	1	<b>11.943,47</b>





### Ventiza EDU con batteria ad acqua di post riscaldamento

	Codice	Classe	Macchina di riferimento	Potenza kW	* Minimo d'ordine	Imballo	Conf.	Euro
								pz
R	<b>140143</b>	VMC	UVE-400S	2,0	6	3	1	<b>9.820,67</b>
R	<b>140144</b>	VMC	UVE-920S	5,3	6	3	1	<b>11.825,67</b>

R Contattare il Customer Service per tempistiche sulla disponibilità





### Filtri F7 per unità di ventilazione meccanica VENTIZA EDU (mandata dell'aria)

	Codice	Classe	Classe ISO 16890	Macchina riferimento	N. pz. per macch.	L	P	H	Minimo d'ordine	Imballo	Conf.	Euro
						mm	mm	mm				pz
	<b>R 141918</b>	VMC	ePM1 70%	EDU 400S	1	345	210	25	1		1	<b>65,94</b>
	<b>R 141920</b>	VMC	ePM1 70%	EDU 920S	1	550	330	48	1		1	<b>158,13</b>



### Filtri F7 per unità di ventilazione meccanica VENTIZA EDU (ripresa dell'aria)

	Codice	Classe	Classe ISO 16890	Macchina riferimento	N. pz. per macch.	L	P	H	Minimo d'ordine	Imballo	Conf.	Euro
						mm	mm	mm				pz
	<b>R 141917</b>	VMC	ePM10 70%	EDU 400S	2	195	220	25	1		1	<b>41,90</b>
	<b>R 141919</b>	VMC	ePM10 70%	EDU 920S	2	345	245	25	1		1	<b>65,94</b>

**R** Contattare il Customer Service per tempistiche sulla disponibilità

# Unità di ventilazione residenziali VENTIZA COMBI



## VENTIZA COMBI SCRKAE (espulsione aria a destra)

Codice	Classe	Modello	Inst.	Portata aria ventil.	Portata L aria deum.	L	P	H	Minimo d'ordine	Imballo	Conf.	Euro
				m <sup>3</sup> /h	m <sup>3</sup> /h	mm	mm	mm				pz
<b>132423</b>	VMC	SCRKAE300	Soffitto	200	300	1000	715	249	1		1	<b>8.038,04</b>
<b>132424</b>	VMC	SCRKAE500	Soffitto	250	500	1195	800	295	1		1	<b>9.651,18</b>

NOTA: l'acquisto di questi articoli e/o dei loro accessori non necessita né include interventi di primo avviamento a meno che siano acquistati con un impianto radiante e relative centraline di controllo Wavin



## VENTIZA COMBI SCRK (espulsione aria a sinistra)

Codice	Classe	Modello	Inst.	Portata aria ventil.	Portata L aria deum.	L	P	H	Minimo d'ordine	Imballo	Conf.	Euro
				m <sup>3</sup> /h	m <sup>3</sup> /h	mm	mm	mm				pz
<b>R 132425</b>	VMC	SCRK600	Soffitto	450	600	1365	900	380	1		1	<b>13.042,13</b>
<b>R 132426</b>	VMC	SCRK700	Soffitto	450	700	1365	900	380	1		1	<b>13.967,71</b>

NOTA: l'acquisto di questi articoli e/o dei loro accessori non necessita né include interventi di primo avviamento a meno che siano acquistati con un impianto radiante e relative centraline di controllo Wavin



## VENTIZA COMBI PCRK

Codice	Classe	Modello	Inst.	Portata aria ventil.	Portata L aria deum.	L	P	H	Minimo d'ordine	Imballo	Conf.	Euro
				m <sup>3</sup> /h	m <sup>3</sup> /h	mm	mm	mm				pz
<b>R 132431</b>	VMC	PCRK300	Basam.	250	300	700	354	1380	1		1	<b>8.594,59</b>
<b>R 132432</b>	VMC	PCRK500	Basam.	350	500	700	434	1690	1		1	<b>12.008,38</b>

NOTA: l'acquisto di questi articoli e/o dei loro accessori non necessita né include interventi di primo avviamento a meno che siano acquistati con un impianto radiante e relative centraline di controllo Wavin



## Schermo EPJ GRAPH per comando utente VENTIZA COMBI

Codice	Classe	Sensori inclusi	Alimentazione	Alloggiamento compatibile	L	P	H	Minimo d'ordine	Imballo	Conf.	Euro
					mm	mm	mm				pz
<b>R 132403</b>	VMC	T+UT	Via cavo dall'unità	Scatola 503	118	111	7	1		1	<b>625,07</b>

**R** Contattare il Customer Service per tempistiche sulla disponibilità



### Sonda ambiente CO<sub>2</sub>

Codice	Classe	Sensori inclusi	Alimentazione	Alloggiamento compatibile	L	P	H	Minimo d'ordine	Imballo	Conf.	Euro
					mm	mm	mm				pz
<b>R 132402</b>	VMC	CO <sub>2</sub>	230V	Scatola DN65	85	100	31	1		1	<b>849,12</b>



### Box filtro F7

Codice	Classe	Macchina riferimento	L	P	H	Minimo d'ordine	Imballo	Conf.	Euro
			mm	mm	mm				pz
<b>R 132441</b>	VMC	SCRKAE (1x300 - 2x500)	423	388	287	1		1	<b>339,58</b>



### Filtri M5 per unità di ventilazione e deumidificazione VENTIZA COMBI

Codice	Classe	Macchina riferimento	N. pz. per macch.	L	P	H	Minimo d'ordine	Imballo	Conf.	Euro
				mm	mm	mm				pz
<b>132937</b>	VMC	SCRKAE300	1 set di 3 filtri						1	<b>112,07</b>
<b>132938</b>	VMC	SCRKAE500	1 set di 3 filtri						1	<b>112,07</b>
<b>R 132939</b>	VMC	SCRK600	1 set di 3 filtri					1	1	<b>112,07</b>
<b>R 132939</b>	VMC	SCRK700	1 set di 3 filtri					1	1	<b>112,07</b>
<b>R 132940</b>	VMC	PCRK300	1 set di 3 filtri					1	1	<b>112,07</b>
<b>R 132941</b>	VMC	PCRK500	1 set di 3 filtri					1	1	<b>112,07</b>

### Filtri F7 per unità di ventilazione e deumidificazione

Codice	Classe	Macchina riferimento	N. pz. per macch.	L	P	H	Minimo d'ordine	Imballo	Conf.	Euro
				mm	mm	mm				pz
<b>R 132936</b>	VMC	PCRK500 BOX F7	1	400	250	200	1		1	<b>169,85</b>

**R** Contattare il Customer Service per tempistiche sulla disponibilità



**Plenum per griglia di mandata/estrazione**

Codice	Classe	Macchina riferimento	Pos. attacco	Ø entrata aria mm	N. entrate aria	L mm	P mm	H mm	Minimo d'ordine	Imballo	Conf.	Euro
												pz
<b>140256</b>	VMC	SCRKAE300	Laterale	160	1	400	200	200	1		1	<b>122,25</b>
<b>140257</b>	VMC	SCRKAE500	Laterale	200	1	500	200	200	1		1	<b>84,26</b>



**Griglia di estrazione ad alette fisse**

Codice	Classe	Materiale	Colore	Macchina riferimento	Portata mass. m³/h	L mm	H mm	Minimo d'ordine	Imballo	Conf.	Euro	
												pz
<b>140276</b>	VMC	Alluminio	Bianco RAL 9003	SCRKAE300	540	400	200	1		1	<b>56,30</b>	
<b>140277</b>	VMC	Alluminio	Bianco RAL 9003	SCRKAE500	690	500	200	1		1	<b>71,24</b>	

# Accessori per unità di ventilazione



## Silenziatori

Codice	Classe	Attenuazione a 250Hz	Diametro lato aria	L	Ø	Spes.	Minimo Imballo d'ordine	Conf.	Euro
		dB(A)	mm	mm	mm	mm			pz
<b>141210</b>	VMC	6,5	125	500	235	55	1	1	<b>186,31</b>
<b>141610</b>	VMC	5	160	500	270	55		1	<b>203,50</b>



## Filtro elettrostatico

Codice	Classe	Diametro lato aria	Efficienza	L	P	H	Minimo Imballo d'ordine	Conf.	Euro
		mm		mm	mm	mm			pz
<b>141640</b>	VMC	160	F8	470	385	243	1	1	<b>1.548,23</b>



## Resistenza antigelo

Codice	Classe	Potenza	Alimentazione	Diametro lato aria	L	P	H	Minimo Imballo d'ordine	Conf.	Euro
		kW	V	mm	mm	mm	mm			pz
<b>R 141630</b>	VMC	0,7	230	160	400	160	260	1	1	<b>627,10</b>
<b>R 141631</b>	VMC	1,4	230	160	400	160	260	1	1	<b>679,39</b>
<b>R 141632</b>	VMC	2,1	230	160	400	160	260	1	1	<b>731,92</b>

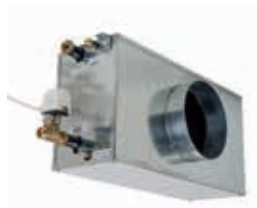

## Batteria di integrazione ad acqua con servovalvola

Codice	Classe	Macchina di riferimento	Diametro lato aria	Diametro lato acqua	L	P	H	Minimo Imballo d'ordine	Conf.	Euro
			mm		mm	mm	mm			pz
<b>R 132411</b>	VMC	REK	160	1/2" M	465	249	240	1	1	<b>547,53</b>

R Contattare il Customer Service per tempistiche sulla disponibilità

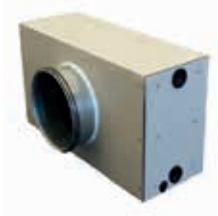

### Batteria di integrazione ad acqua

Codice	Classe	Macchina di riferimento	Diametro lato aria	Diametro lato acqua	L	P	H	Minimo d'ordine	Imballo	Conf.	Euro
			mm		mm	mm	mm				pz
<b>R 132412</b>	VMC	UV3 / REK470	200	1/2"	460	270	300	1	1	1	<b>972,93</b>
<b>R 132413</b>	VMC	140073 140083 140063	250	1/2"	650	330	300	1	1	1	<b>1.229,69</b>
<b>R 132414</b>	VMC	140074 140084 140064	315	3/4"	785	430	350	1	1	1	<b>2.273,06</b>
<b>R 132415</b>	VMC	140075 140085 140065	315	3/4"	780	520	350	1	1	1	<b>2.462,99</b>
<b>R 132416</b>	VMC	140076 140086 140066	355	3/4"	780	520	400	1	1	1	<b>2.747,86</b>
<b>R 132417</b>	VMC	140087 140067	400	1"	895	660	450	1	1	1	<b>3.364,52</b>
<b>R 132418</b>	VMC	140068	400	1"	1000	740	450	1	1	1	<b>3.917,45</b>
<b>R 132419</b>	VMC	140069	450	1"	1000	740	450	1	1	1	<b>3.934,28</b>



### Servovalvola a 2 vie per batteria di integrazione ad acqua

Codice	Classe	Tipo di segnalamento	Macchina di riferimento	Alimentazione	Diametro lato acqua	Minimo d'ordine	Imballo	Conf.	Euro
									pz
<b>R 132405</b>	VMC	ON-OFF	UVN8A/UV3/REK470	230V	1/2"	1	1	1	<b>178,38</b>
<b>R 132406</b>	VMC	ON-OFF	UVN8A	230V	3/4"	1	1	1	<b>203,87</b>
<b>R 132407</b>	VMC	ON-OFF	UVN8A	230V	1"	1	1	1	<b>239,44</b>
<b>R 132408</b>	VMC	0-10V	UVNE	24V	1/2"	1	1	1	<b>537,43</b>
<b>R 132409</b>	VMC	0-10V	UVNE	24V	3/4"	1	1	1	<b>547,65</b>
<b>R 132410</b>	VMC	0-10V	UVNE	24V	1"	1	1	1	<b>580,70</b>

R Contattare il Customer Service per tempistiche sulla disponibilità



# Sistemi di distribuzione aria con tubi circolari in lamiera zincata



## Condotta circolare (Tubo spiro)

Codice	Classe	Materiale	Attacco	L	Ø	Spes.	Minimo Imballo d'ordine	Conf.	Euro	
				mm	mm	mm			m	
<b>R 140804</b>	VMC	Lamiera zincata	FF	3	80	0,5	3	525	3	<b>18,07</b>
<b>R 141004</b>	VMC	Lamiera zincata	FF	3	100	0,5	3	300	3	<b>20,91</b>
<b>R 141204</b>	VMC	Lamiera zincata	FF	3	125	0,5	3	225	3	<b>25,50</b>
<b>141604</b>	VMC	Lamiera zincata	FF	3	160	0,5	3	126	3	<b>33,73</b>
<b>142004</b>	VMC	Lamiera zincata	FF	3	200	0,5	3	75	3	<b>42,01</b>



## Manicotto maschio (per connessioni tra tubi)

Codice	Classe	Materiale	Attacco	Ø	Minimo Imballo d'ordine	Conf.	Euro
				mm			pz
<b>R 140805</b>	VMC	Lamiera zincata	MM	80x80	1	1	<b>5,95</b>
<b>R 141005</b>	VMC	Lamiera zincata	MM	100x100	1	1	<b>6,38</b>
<b>R 141205</b>	VMC	Lamiera zincata	MM	125x125	1	1	<b>6,38</b>
<b>141605</b>	VMC	Lamiera zincata	MM	160x160	1	1	<b>6,65</b>
<b>142005</b>	VMC	Lamiera zincata	MM	200x200	1	1	<b>7,21</b>



## Curva a 90°

Codice	Classe	Materiale	Attacco	Ø	Minimo Imballo d'ordine	Conf.	Euro
				mm			pz
<b>R 140806</b>	VMC	Lamiera zincata	MM	80x80	1	1	<b>20,22</b>
<b>R 141006</b>	VMC	Lamiera zincata	MM	100x100	1	1	<b>20,22</b>
<b>R 141206</b>	VMC	Lamiera zincata	MM	125x125	1	1	<b>24,02</b>
<b>141606</b>	VMC	Lamiera zincata	MM	160x160	1	1	<b>36,02</b>
<b>142006</b>	VMC	Lamiera zincata	MM	200x200	1	1	<b>52,37</b>

R Contattare il Customer Service per tempistiche sulla disponibilità



### Curva a 45° in lamiera zincata

Codice	Classe	Materiale	Attacco	Ø	Minimo Imballo d'ordine	Conf.	Euro
				mm			pz
<b>R 140807</b>	VMC	Lamiera zincata	MM	80x80	1	1	<b>15,28</b>
<b>R 141007</b>	VMC	Lamiera zincata	MM	100x100	1	1	<b>15,28</b>
<b>R 141207</b>	VMC	Lamiera zincata	MM	125x125	1	1	<b>18,35</b>
<b>141607</b>	VMC	Lamiera zincata	MM	160x160	1	1	<b>26,59</b>
<b>R 142007</b>	VMC	Lamiera zincata	MM	200x200	1	1	<b>35,35</b>



### Manicotto femmina (per connessioni tra raccordi)

Codice	Classe	Materiale	Attacco	Ø	Minimo Imballo d'ordine	Conf.	Euro
				mm			pz
<b>R 140815</b>	VMC	Lamiera zincata	FF	80x80	1	1	<b>5,95</b>
<b>R 141015</b>	VMC	Lamiera zincata	FF	100x100	1	1	<b>6,38</b>
<b>R 141215</b>	VMC	Lamiera zincata	FF	125x125	1	1	<b>6,38</b>
<b>141615</b>	VMC	Lamiera zincata	FF	160x160	1	1	<b>6,65</b>
<b>R 142015</b>	VMC	Lamiera zincata	FF	200x200	1	1	<b>7,21</b>

**R** Contattare il Customer Service per tempistiche sulla disponibilità



### Riduzione concentrica

Codice	Classe	Materiale	Attacco	Ø	Minimo Imballo d'ordine	Conf.	Euro
				mm			pz
<b>R 141016</b>	VMC	Lamiera zincata	MM	100x80	1	1	<b>11,85</b>
<b>R 141226</b>	VMC	Lamiera zincata	MM	125x80	1	1	<b>14,44</b>
<b>R 141216</b>	VMC	Lamiera zincata	MM	125x100	1	1	<b>14,44</b>
<b>R 141636</b>	VMC	Lamiera zincata	MM	160x100	1	1	<b>16,30</b>
<b>141616</b>	VMC	Lamiera zincata	MM	160x125	1	1	<b>16,30</b>
<b>R 142027</b>	VMC	Lamiera zincata	MM	200x100	1	1	<b>19,95</b>
<b>142026</b>	VMC	Lamiera zincata	MM	200x125	1	1	<b>19,95</b>
<b>142016</b>	VMC	Lamiera zincata	MM	200x160	1	1	<b>19,95</b>



### Raccordo metallico a T

Codice	Classe	Materiale	Attacco	Ø	Minimo Imballo d'ordine	Conf.	Euro
				mm			pz
<b>R 140817</b>	VMC	Lamiera zincata	MM	80x80x80	1	1	<b>30,91</b>
<b>R 141017</b>	VMC	Lamiera zincata	MM	100x100x100	1	1	<b>32,20</b>
<b>141217</b>	VMC	Lamiera zincata	MM	125x125x125	1	1	<b>36,08</b>
<b>141617</b>	VMC	Lamiera zincata	MM	160x160x160	1	1	<b>49,38</b>
<b>142017</b>	VMC	Lamiera zincata	MM	200x200x200	1	1	<b>68,21</b>

**R** Contattare il Customer Service per tempistiche sulla disponibilità



### Serranda di taratura circolare a farfalla

Codice	Classe	Materiale	Comando	Attacco	L	Ø	H	Minimo d'ordine	Imballo	Conf.	Euro
					mm	mm	mm			pz	
<b>R 141613</b>	VMC	Lamiera zincata	motore	MM	200	160	225	1	1	1	<b>92,30</b>
<b>141614</b>	VMC	Lamiera zincata	manuale	MM	200	160	225	1	1	1	<b>59,43</b>



### Servomotore con ritorno a molla e fine corsa

Codice	Classe	Mod.	Tensione micro	L	P	H	Minimo d'ordine	Imballo	Conf.	Euro
			V	mm	mm	mm			pz	
<b>R 141637</b>	VMC	On/Off	230	140	77	84	1	1	1	<b>750,08</b>



### Serranda di sovrappressione

Codice	Classe	Materiale	Comando	Attacco	L	Ø	H	Minimo d'ordine	Imballo	Conf.	Euro
					mm	mm	mm			pz	
<b>R 141638</b>	VMC	Lamiera zincata	a molla	MM	90	160	90	1	1	1	<b>45,82</b>

R Contattare il Customer Service per tempistiche sulla disponibilità



### Regolatore a membrana a portata costante

Codice	Classe	Portata MIN	Portata MAX	Ø	Minimo Imballo d'ordine	Conf.	Euro
		m <sup>3</sup> /h	m <sup>3</sup> /h	mm			pz
<b>R 141011</b>	VMC	50	100	100	1	1	<b>67,00</b>
<b>R 141211</b>	VMC	100	180	125	1	1	<b>75,81</b>
<b>R 141711</b>	VMC	180	300	160	1	1	<b>112,62</b>
<b>R 142011</b>	VMC	300	500	200	1	1	<b>169,25</b>



### Nastro adesivo

Codice	Classe	Materiale	Resistenza alla trazione	L	P	Spes.	Minimo Imballo d'ordine	Conf.	Euro	
			N/25 mm	m	mm	mm			pz	
<b>140290</b>	VMC	Alluminio	65-70	50	50	0,04	1	24	1	<b>39,10</b>



### Isolante

Codice	Classe	Materiale	Resistenza al fuoco	Conducibilità termica	L	P	Spes.	Minimo Imballo d'ordine	Conf.	Euro
			classe	W/mk	m	m	mm			m <sup>2</sup>
<b>140291</b>	VMC	Lana di vetro con carta kraft	F	0,034	18	1,2	25	21,6	21,6	<b>17,18</b>

**R** Contattare il Customer Service per tempistiche sulla disponibilità

## Sistemi di distribuzione aria a plenum



### Tubo flessibile in alluminio

Codice	Classe	L	Ø	Spes.	Minimo Imballo d'ordine	Conf.	Euro
		m	mm	mm			m
R <b>141001</b>	VMC	10	100	25	10	10	<b>11,98</b>
<b>141201</b>	VMC	10	125	25	10	10	<b>14,43</b>
<b>141601</b>	VMC	10	160	25	10	10	<b>18,44</b>
<b>142001</b>	VMC	10	200	25	10	10	<b>21,48</b>



### Fascette stringi tubo

Codice	Classe	Materiale	Range diametri di chiusura	Ø	Minimo Imballo d'ordine	Conf.	Euro
			mm	mm			pz
R <b>141003</b>	VMC		60-100	100	10	10	<b>3,87</b>
<b>141203</b>	VMC		60-135	125	10	10	<b>4,07</b>
<b>141603</b>	VMC		60-170	160	10	10	<b>4,23</b>
<b>142003</b>	VMC		60-203	200	10	10	<b>4,91</b>



### Condotto circolare in EPE

Codice	Classe	L	Ø int.	Spes.	Minimo Imballo d'ordine	Conf.	Euro
		mm	mm	mm			pz
R <b>141220</b>	VMC	2000	125	16	1	1	<b>110,08</b>
<b>141620</b>	VMC	2000	160	16	1	1	<b>130,18</b>

R Contattare il Customer Service per tempistiche sulla disponibilità



### Curva 90° in EPE

Codice	Classe	Ø int.	Spes.	Minimo Imballo d'ordine	Conf.	Euro
		mm	mm			pz
R 141221	VMC	125	16	1	1	<b>33,56</b>
141621	VMC	160	16	1	1	<b>39,59</b>



### Curva 45° in EPE

Codice	Classe	Ø int.	Spes.	Minimo Imballo d'ordine	Conf.	Euro
		mm	mm			pz
R 141222	VMC	125	16	1	1	<b>26,50</b>
141622	VMC	160	16	1	1	<b>30,72</b>



### Raccordo a T in EPE

Codice	Classe	Ø int.	Spes.	Minimo Imballo d'ordine	Conf.	Euro
		mm	mm			pz
R 141635	VMC	160	16	1	1	<b>102,45</b>



### Raccordo per condotti in EPE

Codice	Classe	Ø	Minimo Imballo d'ordine	Conf.	Euro
		mm			pz
R 141223	VMC	125	1	1	<b>21,08</b>
141623	VMC	160	1	1	<b>12,35</b>



### Collare di fissaggio

Codice	Classe	Ø	Minimo Imballo d'ordine	Conf.	Euro
		mm			pz
R 141224	VMC	125	1	1	<b>11,15</b>
141624	VMC	160	1	1	<b>16,37</b>

R Contattare il Customer Service per tempistiche sulla disponibilità



**Plenum di distribuzione in acciaio isolato con ingresso circolare ed attacchi modulari**

Codice	Classe	Ø ing. aria	N. ing. aria	Ø usc. aria	N. usc. aria	L	P	H	Minimo d'ordine	Imballo	Conf.	Euro
		mm		mm		mm	mm	mm				pz
<b>147524</b>	VMC	160	1	75	4	287	442	202	1		1	<b>300,27</b>
<b>147525</b>	VMC	160	1	75	6	412	442	202	1		1	<b>372,27</b>
<b>147526</b>	VMC	160	1	75	10	674	442	202	1		1	<b>495,73</b>



**Plenum di distribuzione in acciaio isolato con ingresso rettangolare ed attacchi modulari per REK180M-250M**

Codice	Classe	Dimens. ing. aria	N. ing. aria	Ø usc. aria	N. usc. aria	L	P	H	Minimo d'ordine	Imballo	Conf.	Euro
		mm		mm		mm	mm	mm				pz
<b>4080615</b>	VMC	285x190	2	75/90	6+6	750	250	251	1		1	<b>620,13</b>



**Set accessori per bocchette multiple**

Codice	Classe	Ø lato plenum	Ø lato tubazione	Minimo d'ordine	Imballo	Conf.	Euro
		mm	mm				pz
<b>147561</b>	VMC	75	75	5	25	5	<b>12,86</b>
<b>147562</b>	VMC	75	90	5	25	5	<b>24,50</b>
<b>147563</b>	VMC	75	102x50	5	25	5	<b>38,55</b>







### Tubo flessibile corrugato



Non isolato



Isolato

Codice	Classe	Isolato	L	Ø est.	Spes. tubo	Spes. Isolam.	Minimo d'ordine	Imballo	Conf.	Euro
			m	mm	mm	mm				m
<b>147501</b>	VMC	NO	50	75	6		50	50		<b>5,97</b>
<b>149001</b>	VMC	NO	50	90	7		50	50		<b>8,11</b>
<b>NEW</b> R <b>147502</b>	VMC	SI	25	87	6	6	25	25		<b>27,93</b>
<b>NEW</b> R <b>149002</b>	VMC	SI	25	102	7	6	25	25		<b>33,18</b>



### Connettore di giunzione per tubo corrugato

Codice	Classe	Ø	Minimo d'ordine	Imballo	Conf.	Euro
		mm				pz
<b>147510</b>	VMC	75	1	70	1	<b>6,46</b>
<b>149010</b>	VMC	90	1	42	1	<b>10,99</b>



### Curva 90° per tubo corrugato

Codice	Classe	Ø	Minimo d'ordine	Imballo	Conf.	Euro
		mm				pz
<b>147515</b>	VMC	75	5	30	5	<b>19,54</b>



### Clip di fissaggio per tubo corrugato

Codice	Classe	Colore	Ø	Minimo d'ordine	Imballo	Conf.	Euro
			mm				pz
<b>147516</b>	VMC	Blu	75	48	480	48	<b>1,49</b>
<b>149016</b>	VMC	Blu	90	48	336	48	<b>1,76</b>

R Contattare il Customer Service per tempistiche sulla disponibilità



### Tubo ovale semirigido in PE

Codice	Classe	L	Dimensione ovale	Minimo Imballo d'ordine	Conf.	Euro
		m	mm			m
<b>145002</b>	VMC	50	102x50	50	50	<b>19,14</b>



### Connettore di giunzione per tubo ovale

Codice	Classe	Dimensioni	Minimo Imballo d'ordine	Conf.	Euro
		mm			pz
<b>R 145015</b>	VMC	102x50	1	1	<b>29,94</b>



### Curva 90° verticale in PE per tubo ovale

Codice	Classe	Dimensione attacco ovale	Minimo Imballo d'ordine	Conf.	Euro
		mm			pz
<b>R 145010</b>	VMC	102x50	1	1	<b>39,92</b>



### Curva 90° orizzontale in PE per tubo ovale

Codice	Classe	Dimensione attacco ovale	Minimo Imballo d'ordine	Conf.	Euro
		mm			pz
<b>R 145011</b>	VMC	102x50	1	1	<b>44,01</b>

**R** Contattare il Customer Service per tempistiche sulla disponibilità



### Adattatore 90° tubo ovale - tubo tondo DN75

Codice	Classe	Dimensione attacco tondo	Dimensione attacco ovale	Minimo Imballo d'ordine	Conf.	Euro
		mm	mm			pz
<b>R 145012</b>	VMC	75	102x50	1	1	<b>38,25</b>



### Adattatore 180° tubo ovale - raccordo tondo DN75 (147537)

Codice	Classe	Ø lato raccordo	Dimensione lato tubazione	Minimo Imballo d'ordine	Conf.	Euro
		mm	mm			pz
<b>R 147532</b>	VMC	80	102x50	1	1	<b>30,06</b>



### Adattatore 180° tubo tondo DN90 - raccordo tondo DN75 (147537)

Codice	Classe	Ø lato raccordo	Ø lato tubazione	Minimo Imballo d'ordine	Conf.	Euro
		mm	mm			pz
<b>R 147533</b>	VMC	80	90	1	1	<b>30,06</b>



### Raccordo tra adattatore 180° e tubo tondo DN75

Codice	Classe	Ø lato plenum	Ø lato tubazione	Minimo Imballo d'ordine	Conf.	Euro
		mm	mm			pz
<b>R 147537</b>	VMC	80	75	1	1	<b>11,42</b>

R Contattare il Customer Service per tempistiche sulla disponibilità



**Collare di fissaggio per tubo ovale**

Codice	Classe	Dimensioni	Minimo Imballo d'ordine	Conf.	Euro
		mm			pz
R <b>145014</b>	VMC	102x50	10	10	<b>9,14</b>



**Anello antisfilamento per tubo ovale**

Codice	Classe	Dimensioni	Minimo Imballo d'ordine	Conf.	Euro
		mm			pz
<b>145016</b>	VMC	102x50	10	10	<b>15,35</b>



**Anello antisfilamento per tubo tondo**

Codice	Classe	Ø	Minimo Imballo d'ordine	Conf.	Euro
		mm			pz
<b>145020</b>	VMC	75	10	120	<b>2,42</b>
R <b>145023</b>	VMC	90	10	120	<b>4,54</b>



**Guarnizione a tenuta per tubo PE**

Codice	Classe	Ø	Minimo Imballo d'ordine	Conf.	Euro
		mm			pz
<b>145019</b>	VMC	75	10	10	<b>3,75</b>
R <b>145022</b>	VMC	90	10	10	<b>4,95</b>

R Contattare il Customer Service per tempistiche sulla disponibilità.

# Terminali di aspirazione e immissione



## Collare telescopico

Codice	Classe	L	Ø	Minimo Imballo d'ordine	Conf.	Euro
		mm	mm			pz
<b>141612</b>	VMC	400+300	160	1	1	<b>109,73</b>



## Griglia da esterno bianca con rete antivolatile

Codice	Classe	Materiale	Colore	Ø	H	Minimo Imballo d'ordine	Conf.	Euro
				mm	mm			pz
<b>141225P</b>	VMC	Plastica	Bianco RAL 9016	125	25	1	1	<b>8,36</b>
<b>141625P</b>	VMC	Plastica	Bianco RAL 9016	160	25	1	1	<b>8,57</b>
<b>142025</b>	VMC	Alluminio	Bianco RAL 9003	200	20	1	1	<b>54,88</b>





## Griglia di aspirazione a parete

Codice	Classe	Ø	Minimo Imballo d'ordine	Conf.	Euro
		mm			pz
<b>141627</b>	VMC	160	1	1	<b>233,44</b>



## Terminale attraversamento tetto

Codice	Classe	Tipologia	Ø	Minimo Imballo d'ordine	Conf.	Euro
			mm			pz
 <b>R 141680</b>	VMC	Tetto piano	160	1	1	<b>318,15</b>
 <b>R 141681</b>	VMC	Tetto inclinato	160	1	1	<b>385,35</b>



## Riduzione per terminale attraversamento tetto

Codice	Classe	Ø	Minimo Imballo d'ordine	Conf.	Euro
		mm			pz
 <b>R 141682</b>	VMC	125-160	1	1	<b>45,15</b>

**R** Contattare il Customer Service per tempistiche sulla disponibilità.



**Bocchetta multipla in ABS**

Codice	Classe	N. attacchi Ø75 di serie	N. attacchi Ø75 max	Poss. posiz. di attacco	Portata aria mas. m <sup>3</sup> /h	L mm	P mm	H mm	Minimo d'ordine	Imballo	Conf.	Euro
<b>147560</b>	VMC	1	2	5	60*	257	90	107	1	10	1	<b>78,05</b>

\*La bocchetta multipla in ABS può essere abbinata alla griglia Saturno - cod. 140232 - fino ad una portata massima di 90 m<sup>3</sup>/h. In tal caso le perdite di carico della bocchetta sono di 25 Pa.



**Bocchetta multipla metallica**

Codice	Classe	Ø ing. aria mm	N. ing. aria	Ø usc. aria mm	N. usc. aria	L mm	P mm	H mm	Minimo d'ordine	Imballo	Conf.	Euro
<b>147564</b>	VMC	7	16	75	3	350	90	150	5	5	1	<b>122,01</b>



**14 75 61**

**Set accessori per bocchette multiple**

Codice	Classe	Ø lato plenum mm	Ø lato tubazione mm	Minimo d'ordine	Imballo	Conf.	Euro
<b>147561</b>	VMC	75	75	5	25	5	<b>12,86</b>
<b>147562</b>	VMC	75	90	5	25	5	<b>24,50</b>
<b>147563</b>	VMC	75	102x50	5	25	5	<b>38,55</b>



**14 75 62**



**14 75 63**



**14 02 30**



**14 02 31**



**14 02 32**



**14 02 33**



**14 02 34**

**Griglia per bocchette multipla in ABS**

Codice	Classe	Materiale	Colore	Modello	Portata aria mas.	L	H	Minimo d'ordine	Imballo	Conf.	Euro
					m <sup>3</sup> /h	mm	mm				pz
<b>140230</b>	VMC	Acciaio	Bianco RAL 9003	Plutone	60	250	100	1	5	1	<b>81,45</b>
<b>140231</b>	VMC	Acciaio	Bianco RAL 9003	Venere	60	250	100	1	5	1	<b>118,51</b>
<b>140232</b>	VMC	Acciaio	Bianco RAL 9003	Saturno	90	250	100	1	5	1	<b>73,48</b>
<b>140233</b>	VMC	Acciaio	Bianco RAL 9003	Nettuno	60	250	100	1	5	1	<b>81,38</b>
<b>140234</b>	VMC	Acciaio	Bianco RAL 9003	Terra	60	250	100	1	5	1	<b>88,43</b>



**Filtro per griglia per bocchette multipla in ABS**

Codice	Classe	Classe filtro EN779	Griglia riferimento	Numero pz. per griglia	L	H	Minimo d'ordine	Imballo	Conf.	Euro
					mm	mm				pz
<b>140237</b>	VMC	G3	14 02 3x	1	250	100	5	5	5	<b>25,08</b>

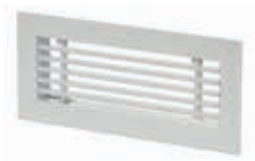

**Griglie immissione/estrazione ad alette fisse**

Codice	Classe	Materiale	Colore	Portata aria massima	L	H	Minimo d'ordine	Imballo	Conf.	Euro
				m <sup>3</sup> /h	mm	mm				pz
<b>140206</b>	VMC	Alluminio	Bianco RAL9003	60	250	100	1		1	<b>54,03</b>
<b>140203</b>	VMC	Alluminio	Bianco RAL9003	90	350	150	1		1	<b>89,12</b>



**Griglia con schermo forellato**

Codice	Classe	Materiale	Colore	Portata aria massima	L	H	Minimo d'ordine	Imballo	Conf.	Euro
				m <sup>3</sup> /h	mm	mm				pz
<b>140234</b>	VMC	Acciaio	Bianco RAL9003	60	250	100	1		1	<b>88,43</b>
<b>140213</b>	VMC	Acciaio	Bianco RAL9003	90	350	150	1		1	<b>113,25</b>



**Filtro G3 per griglia con schermo forellato**

Codice	Classe	Griglia di riferimento	Numero pz. per griglia	L	H	Minimo d'ordine	Imballo	Conf.	Euro
				mm	mm				pz
<b>140237</b>	VMC	14 02 3x	1	250	100	5		5	<b>25,08</b>
<b>R 140216</b>	VMC	14 02 13	1	350	150	5		5	<b>23,66</b>

R Contattare il Customer Service per tempistiche sulla disponibilità.





## Plenum per griglia di mandata/estrazione

Codice	Classe	Posizione attacco	Ø ing. aria	N. ing. aria	L	P	H	Minimo d'ordine	Imballo	Conf.	Euro
			mm		mm	mm	mm				pz
<b>R 140242</b>	VMC	Posteriore	100	1	200	200	100	1		1	<b>58,62</b>
<b>R 140243</b>	VMC	Posteriore	125	1	300	200	150	1		1	<b>65,17</b>
<b>R 140245</b>	VMC	Posteriore	160	1	300	200	200	1		1	<b>68,00</b>
<b>R 140246</b>	VMC	Posteriore	160	1	400	200	200	1		1	<b>71,66</b>
<b>R 140247</b>	VMC	Posteriore	200	1	500	200	200	1		1	<b>74,77</b>



## Plenum per griglia di mandata/estrazione

Codice	Classe	Posizione attacco	Ø ing. aria	N. ing. aria	L	P	H	Minimo d'ordine	Imballo	Conf.	Euro
			mm		mm	mm	mm				pz
<b>R 140252</b>	VMC	Laterale	100	1	200	200	100	1		1	<b>59,33</b>
<b>R 140253</b>	VMC	Laterale	125	1	300	200	150	1		1	<b>68,83</b>
<b>R 140255</b>	VMC	Laterale	160	1	300	200	200	1		1	<b>72,01</b>
<b>140256</b>	VMC	Laterale	160	1	400	200	200	1		1	<b>122,25</b>
<b>140257</b>	VMC	Laterale	200	1	500	200	200	1		1	<b>84,26</b>

R Contattare il Customer Service per tempistiche sulla disponibilità.



### Griglia di mandata ad alette orientabili

Codice	Classe	Materiale	Colore	Portata aria massima	L	H	Minimo d'ordine	Imballo	Conf.	Euro
				m <sup>3</sup> /h	mm	mm				pz
R <b>140262</b>	VMC	Alluminio	Bianco RAL 9003	220	200	100	1		1	<b>46,08</b>
R <b>140263</b>	VMC	Alluminio	Bianco RAL 9003	550	300	150	1		1	<b>62,57</b>
R <b>140265</b>	VMC	Alluminio	Bianco RAL 9003	760	300	200	1		1	<b>88,08</b>
R <b>140266</b>	VMC	Alluminio	Bianco RAL 9003	1030	400	200	1		1	<b>99,44</b>
R <b>140267</b>	VMC	Alluminio	Bianco RAL 9003	1300	500	200	1		1	<b>119,72</b>



### Griglia di estrazione ad alette fisse

Codice	Classe	Materiale	Colore	Portata aria massima	L	H	Minimo d'ordine	Imballo	Conf.	Euro
				m <sup>3</sup> /h	mm	mm				pz
R <b>140272</b>	VMC	Alluminio	Bianco RAL 9003	120	200	100	1		1	<b>31,49</b>
R <b>140273</b>	VMC	Alluminio	Bianco RAL 9003	290	300	150	1		1	<b>43,13</b>
R <b>140275</b>	VMC	Alluminio	Bianco RAL 9003	400	300	200	1		1	<b>51,38</b>
<b>140276</b>	VMC	Alluminio	Bianco RAL 9003	540	400	200	1		1	<b>56,30</b>
<b>140277</b>	VMC	Alluminio	Bianco RAL 9003	690	500	200	1		1	<b>71,24</b>

R Contattare il Customer Service per tempistiche sulla disponibilità.



### Plenum per diffusore lineare

Codice	Classe	Posizione attacco	Ø ing. aria mm	N. ing. aria	L mm	P mm	H mm	Minimo Imballo d'ordine	Conf.	Euro
<b>140239</b>	VMC	Laterale	75	2	560	140	68		1	<b>156,39</b>



### Diffusori lineari in alluminio - 1 feritoria con deflettore a goccia

Codice	Classe	Materiale	Colore	Portata aria massima m³/h	L mm	H mm	Minimo Imballo d'ordine	Conf.	Euro
<b>140226</b>	VMC	Alluminio	Bianco RAL 9003	140	500	60		1	<b>86,61</b>



**Adattatore Ø125 1tappo-2xattacco lat. Ø75 antistatico/antibatterico**

Codice	Classe	N. ingressi aria tondi	Ø attacco tondo	Ø Bocchetta	Minimo d'ordine	Imballo	Conf.	Euro
			mm	mm				pz
<b>145021</b>	VMC	2	75	125	1		1	<b>84,53</b>



**Plenum per valvola tonda e griglia modello Borea**

Codice	Classe	Ø ing. aria	N. ing. aria	Ø usc. aria	N. usc. aria	L	P	H	Minimo d'ordine	Imballo	Conf.	Euro
		mm		mm		mm	mm	mm				pz
<b>R 140850</b>	VMC	75	1	80	1	120	120	90	1		1	<b>90,84</b>
<b>R 141250</b>	VMC	75	2	125	1	180	180	90	1		1	<b>117,96</b>



**Griglia di immissione/estrazione tonda modello Borea**

Codice	Classe	Materiale	Colore	Portata aria massima	Ø	Minimo d'ordine	Imballo	Conf.	Euro
				m³/h	mm				pz
<b>140851</b>	VMC	Plastica	Bianco	45	80	1	90	1	<b>46,19</b>
<b>141251</b>	VMC	Plastica	Bianco	150	125	1	30	1	<b>47,27</b>



**Valvola di immissione/estrazione tonda**

Codice	Classe	Materiale	Colore	Portata aria massima	Ø	Minimo d'ordine	Imballo	Conf.	Euro
				m³/h	mm				pz
<b>141252</b>	VMC	Acciaio	Bianco RAL 9010	90	125	1		1	<b>16,70</b>

R Contattare il Customer Service per tempistiche sulla disponibilità

## Articoli VMC obsoleti (presenti a listino fino ad esaurimento scorte)



### Comando utente a muro per REK60A

Codice	Classe	Sensori inclusi	Aliment.	Alloggiamento compatibile	L	P	H	Minimo d'ordine	Imballo	Conf.	Euro
					mm	mm	mm				pz
<b>140132A</b>	VMC	UR +crepuscolare	230V	Scatola 503	121	22	77	1		1	<b>242,43</b>
<b>R 140133A</b>	VMC	CO2+UR +crepuscolare	230V	Scatola 503	121	22	77	1		1	<b>1.078,17</b>



### VENTIZA DUO REK160LE orizzontali/verticali



Codice	Classe	Modello	Install.	Recup.	Portata aria nominale	L	P	H	Minimo d'ordine	Imballo	Conf.	Euro
					m <sup>3</sup> /h	mm	mm	mm				pz
<b>140007</b>	VMC	REK160LE	Sof./Par.	Entalpico	160	900	580	269	1		1	<b>3.290,16</b>



### VENTIZA DUO REK140 orizzontali (include regolatore di velocità)

Codice	Classe	Modello	Install.	Recup.	Portata aria nominale	L	P	H	Minimo d'ordine	Imballo	Conf.	Euro
					m <sup>3</sup> /h	mm	mm	mm				pz
<b>140005</b>	VMC	REK140	Soffitto	Sensibile	160	900	550	268	1		1	<b>1.912,96</b>

**R** Contattare il Customer Service per tempistiche sulla disponibilità



### Raccordo metallico a T ridotto

Codice	Classe	Materiale	Attacco	Ø	Minimo Imballo d'ordine	Conf.	Euro
				mm			pz
<b>R 141619</b>	VMC	Lamiera zincata	MM	160x100x160	1	1	<b>61,82</b>



### Terminale attraversamento tetto

Codice	Classe	Ø	Minimo Imballo d'ordine	Conf.	Euro
		mm			pz
<b>141634</b>	VMC	125-160	1	1	<b>270,06</b>



### Faldale per terminale attraversamento

Codice	Classe	Inclinazione regolabile	L	Ø	H	Minimo Imballo d'ordine	Conf.	Euro
			mm	mm	mm			pz
<b>141629</b>	VMC	25° - 45°	500	125-160	600	1	1	<b>198,74</b>

**R** Contattare il Customer Service per tempistiche sulla disponibilità

# Controlli



# Sistema Sentio



## Sonda ambiente con display Sentio

Codice	Classe	Connessione	Tipo	Aliment.	A	B	H	Minimo Imballo d'ordine	Conf.	Euro
					mm	mm	mm			
<b>3077000</b>	CFD	Cavo a 4 poli	Sonda T/H	Via cavo	63	85	20	1	1	<b>207,82</b>
<b>3077001</b>	CFD	Wireless	Sonda T/H	2xAA	63	85	20	1	1	<b>196,28</b>
<b>R 3077004</b>	CFD	Wireless	Sonda T/H+IR	2xAA	63	85	20	1	1	<b>273,53</b>



## Sonda ambiente cieca Sentio

Codice	Classe	Connessione	Tipo	Aliment.	A	B	H	Minimo Imballo d'ordine	Conf.	Euro
					mm	mm	mm			
<b>3077002</b>	CFD	Cavo a 4 poli	Sonda T/H	Via cavo	63	85	20	1	1	<b>153,19</b>
<b>R 3077003</b>	CFD	Wireless	Sonda T/H	2xAA	63	85	20	1	1	<b>145,81</b>



## Adattatore scatola tonda per sonda ambiente Sentio

Codice	Classe	A	B	H	Minimo Imballo d'ordine	Conf.	Euro
		mm	mm	mm			
<b>4063803</b>	CFD	93	93	23	1	1	<b>24,63</b>



## Scatola da incasso

Codice	Classe	Ø	H	Minimo Imballo d'ordine	Conf.	Euro
		mm	mm			
<b>120300</b>	CFD	65	62	5	5	<b>8,70</b>

**R** Contattare il Customer Service per tempistiche sulla disponibilità.





### Centralina Sentio, 8 zone

Codice	Classe	Connessione	N° moduli Din	Firmware	A	B	H	Minimo d'ordine	Imballo	Conf.	Euro
					mm	mm	mm				pz
<b>4063796</b>	CFD	Cavo RS485	13	Standard	228	110	55	1		1	<b>650,72</b>
<b>R** 2449643</b>	CFD	Cavo RS485	13	Ventiza	228	110	55	1		1	<b>650,72</b>



### Estensione per centralina Sentio, 8 zone aggiuntive

Codice	Classe	Connessione	N° moduli Din	A	B	H	Minimo d'ordine	Imballo	Conf.	Euro
				mm	mm	mm				pz
<b>4063800</b>	CFD	Cavo RS485	5	88	110	55	1		1	<b>195,80</b>



### Estensione per centralina Sentio, 6 contatti puliti

Codice	Classe	Connessione	N° moduli Din	A	B	H	Minimo d'ordine	Imballo	Conf.	Euro
				mm	mm	mm				pz
<b>4063801</b>	CFD	Cavo RS485	5	88	110	55	1		1	<b>301,02</b>



### Schermo touch per centralina Sentio

Codice	Classe	Connessione	Firmware	A	B	H	Minimo d'ordine	Imballo	Conf.	Euro
				mm	mm	mm				pz
<b>4063802</b>	CFD	Cavo 8 poli	Standard	91	78	25	1		1	<b>325,42</b>
<b>R** 2449644</b>	CFD	Cavo 8 poli	Ventiza	91	78	25	1		1	<b>325,42</b>

**R** Contattare il Customer Service per tempistiche sulla disponibilità.

\*\* Necessita una diversa configurazione di Ventiza HP



**Sonda di temperatura a pavimento per sonda ambiente cablata Sentio**

Codice	Classe	Connessione	Tipo	A	Ø	Minimo d'ordine	Imballo	Conf.	Euro
				mm	mm				pz
<b>4063810</b>	CFD	Cavo	NTC10K	3000	4,5	1		1	<b>91,60</b>



**Sonda di temperatura a contatto per centralina Sentio**

Codice	Classe	Connessione	Tipo	A	B	H	Minimo d'ordine	Imballo	Conf.	Euro
				mm	mm	mm				pz
<b>4064150</b>	CFD	Cavo	NTC10K	26	55	29	1		1	<b>61,93</b>



**Sonda di temperatura esterna per centralina Sentio**

Codice	Classe	Connessione	Alimentazione	A	B	H	Minimo d'ordine	Imballo	Conf.	Euro
				mm	mm	mm				pz
<b>4063806</b>	CFD	Via Bus	Via cavo	90	110	35	1		1	<b>174,97</b>
<b>4063807</b>	CFD	Wireless	1xCR123A	90	110	35	1		1	<b>197,11</b>
<b>4063808</b>	CFD	Cavo	n/d	26	55	29	1		1	<b>65,64</b>



**Antenna esterna per centralina Sentio**

Codice	Classe	Connessione	A	B	H	Minimo d'ordine	Imballo	Conf.	Euro
			mm	mm	mm				pz
<b>R 4063809</b>	CFD	Cavo 3 pin	48	128	30	1		1	<b>103,21</b>

R Contattare il Customer Service per tempistiche sulla disponibilità.



### Termostato elettronico da radiatore Sentio

Codice	Classe	Connessione	Tipo	Aliment.	A	Ø		Minimo Imballo d'ordine	Conf.	Euro
					mm	mm				pz
<b>4063805</b>	CFD	Wireless	Sonda T	3xAA	85	90		1	1	<b>182,11</b>



### Orologio digitale Finder

Codice	Classe	Tensione	Tipo Contatti	N° moduli DIN	A	B	H	Minimo Imballo d'ordine	Conf.	Euro
		V			mm	mm	mm			pz
<b>4067612</b>	CFD	230	1 x N.A.	2	35	89	61	1	1	<b>307,08</b>
<b>4067613</b>	CFD	230	2 x N.A.	2	35	89	61	1	1	<b>332,56</b>



### Sentio Wifi Bridge

Codice	Classe	Tensione	Tipo Contatti	N° moduli DIN	A	B	H	Minimo Imballo d'ordine	Conf.	Euro
		V			mm	mm	mm			pz
<b>R 4065599</b>	CFD							1	1	<b>55,83</b>

R Contattare il Customer Service per tempistiche sulla disponibilità.

# Sistema Reklima Bus RKB



## Sonda ambiente con schermo RKB

Codice	Classe	Connessione	Tipo	Ten.	A	B	H	Minimo Imballo d'ordine	Conf.	Euro
				V	mm	mm	mm			pz
<b>130341</b>	CFD	Cavo RS485	Sonda T/H	230	86	86	23	1	1	<b>495,28</b>
<b>R 130342</b>	CFD	Cavo RS485	Sonda T	230	86	86	23	1	1	<b>385,41</b>



## Scatola da incasso

Codice	Classe	Ø	H	Minimo Imballo d'ordine	Conf.	Euro
		mm	mm			pz
<b>120300</b>	CFD	65	62	5	5	<b>8,70</b>



## Centralina RKB

Codice	Classe	Tens.	Modello	N° moduli digitali DIN	In/Out	A	B	H	Minimo Imballo d'ordine	Conf.	Euro
		V				mm	mm	mm			pz
* <b>130205</b>	CFD	24	RKB-2 7	6	5/7	105	115	65	1	1	<b>1.410,47</b>
* <b>130206</b>	CFD	24	RKB-2 8	13	8/8	230	115	65	1	1	<b>2.134,15</b>
<b>R 130207</b>	CFD	24	RKB-2 13	18	14/13	315	115	65	1	1	<b>2.557,88</b>
<b>R 130208</b>	CFD	24	RKB-2 18	18	14/18	315	115	65	1	1	<b>2.919,73</b>
<b>R 130209</b>	CFD	24	RKB-2 29	18	14/29	315	115	65	1	1	<b>3.038,76</b>



## Schede di comunicazione RKB

Codice	Classe	Tipo	Modelli compatibili	Minimo Imballo d'ordine	Conf.	Euro
						pz
<b>R 130211</b>	CFD	PCOWEB	RKB / RKB-2	1	1	<b>1.327,14</b>
<b>R 130212</b>	CFD	KONNEX	RKB / RKB-2	1	1	<b>802,83</b>
<b>R 130213</b>	CFD	RS485	RKB / RKB-2	1	1	<b>329,23</b>

**R** Contattare il Customer Service per tempistiche sulla disponibilità.

\* Ad esaurimento



### Sonda di temperatura di mandata RKB

Codice	Classe	Connessione	Tipo	A	Ø	Minimo Imballo d'ordine	Conf.	Euro
				mm	mm			pz
<b>130145</b>	CFD	Cavo	NTC10K	1500	4,9	1	1	<b>8,43</b>



### Pozzetto per sonda di mandata

Codice	Classe	A	Ø	Minimo Imballo d'ordine	Conf.	Euro
		mm	mm			pz
<b>130146</b>	CFD	107	6,5	1	1	<b>46,40</b>



### Sonda esterna

Codice	Classe	Conness.	Tipo	Modelli compatibili	A	B	H	Minimo Imballo d'ordine	Conf.	Euro
					mm	mm	mm			pz
<b>R 130143</b>	CFD	Cavo	NTC10K	RKB/RKB-2	98	170	44	1	1	<b>164,02</b>

## Regolatori ambiente monozona



### Igrostato

Codice	Classe	Tipo	Alimentazione	A	B	H	Minimo Imballo d'ordine	Conf.	Euro
				mm	mm	mm			pz
<b>130162</b>	CFD	Solo umidità	230 V	69	51	50	1	1	<b>412,60</b>

**R** Contattare il Customer Service per tempistiche sulla disponibilità.

## Modalità di richiesta della prima accensione

La prima accensione di un impianto deve essere richiesta contattando direttamente il Centro Assistenza Tecnica di zona. I riferimenti dei Centri Assistenza Tecnica autorizzati sono disponibili presso la sezione contatti del sito [www.wavin.it](http://www.wavin.it).

Il Centro Assistenza Tecnica potrà inviare il modulo di primo avviamento che gli dovrà essere restituito debitamente compilato, timbrato e firmato in ogni sua parte.

L'avviamento verrà fatturato dal Centro Assistenza Tecnica, secondo le proprie modalità, direttamente al richiedente della prima accensione secondo il seguente tariffario:

Prima accensione sistema con centralina di regolazione di tipo:		Prezzo
A)	WTC*	150 €
B1)	ReklimaBus-2 7*	100 €
B2)	ReklimaBus-2 8*	100 €
B3)	ReklimaBus-2 13	150 €
B4)	ReklimaBus-2 18	200 €
B5)	ReklimaBus-2 29	250 €
C1)	Sentio – unità base per impianto solo caldo	100 €
C2)	Sentio – unità base per impianto caldo/freddo	150 €
C3)	Sentio – unità di espansione contatti puliti (da sommarsi al costo base dei punti C1 o C2)	+50 €
C4)	Sentio – unità di espansione zone (da sommarsi al costo base dei punti C1 o C2)	+50 €
C5)	Sentio – configurazione applicazione (da sommarsi al costo base dei punti C1 o C2)	+30 €

\*Fino ad esaurimento

Prima accensione unità di deumidificazione:		Prezzo
D)	Gamma Deuklima	Incluso con prima accensione centralina Solo se avviato singolarmente, 100€

Prima accensione unità di ventilazione meccanica controllata:		Prezzo
E)	Gamma unità residenziali Ventiza HP, Ventiza Solo, Ventiza Duo, Ventiza Floor, Ventiza IN	100 €
F)	Gamma unità non residenziali UVN	100 €

Prima accensione unità di ventilazione e deumidificazione:		Prezzo
G)	Gamma Ventiza Combi	100 €

Altri servizi:		Prezzo
H)	Bilanciamento impianto di ventilazione meccanica controllata (prezzo per bocchetta)	10 €
I)	Sopralluogo in cantiere durante le fasi di installazione o per verifica di preaccensione	Da concordare

Il primo avviamento è comprensivo di un solo diritto di chiamata e viaggio di andata e ritorno entro le 2 ore.

I prezzi sono da considerarsi netti IVA esclusa.

## Modalità di esecuzione della prima accensione

L'intervento del Centro Assistenza Tecnica dovrà avvenire ad impianto terminato (quindi cablato, riempito, collegato). Tali condizioni essenziali sono richieste nei moduli di primo avviamento che il Centro Assistenza Tecnica trasmetterà al cliente per la loro compilazione.

Le operazioni che il Centro Assistenza eseguirà durante la prima accensione saranno:

1. verifica dei collegamenti elettrici;
2. configurazione del prodotto sulle necessità del cliente;
3. verifica dell'invio e delle ricezioni dei consensi agli altri dispositivi che compongono il sistema;
4. formazione dell'utilizzatore sull'utilizzo del prodotto per le eventuali modifiche dei parametri disponibili per l'utente;

Il Centro Assistenza Tecnica non:

1. eseguirà installazioni supplementari di nessun genere;
2. collegherà impianti elettrici o idraulici.

Il Centro Assistenza Tecnica, al termine del primo avviamento, compilerà un foglio di lavoro che dovrà essere firmato dal cliente per sua accettazione. Una copia di tale documento sarà consegnata al cliente.

## WAVIN TERMINI E CONDIZIONI DI VENDITA

Qualsiasi fornitura di Prodotti e/o Servizi (ciascuno come definito di seguito) da parte di un membro del gruppo Wavin specificato in un Ordine di Acquisto (come definito di seguito) ("Venditore") alla persona, impresa o società che acquista i Prodotti e/o i Servizi dal Venditore ("Cliente") (ciascuno di essi indicato anche come una "Parte", e collettivamente come le "Parti") sarà soggetto ai presenti termini e condizioni generali di vendita (i "Termini e Condizioni") e costituirà l'intero ed esclusivo accordo tra il Venditore e il Cliente. Qualsiasi accordo precedente stipulato da e tra le parti è sostituito dal Contratto (come definito di seguito) e qualsiasi termine aggiuntivo o diverso proposto dal Cliente (compresi qualsiasi termine e condizione generale di acquisto da parte del Cliente) che il Cliente cerca di imporre o incorporare è espressamente respinto, indipendentemente dal fatto che il Cliente faccia riferimento a tali termini in una richiesta di preventivo, altra comunicazione rivolta al Venditore o altro, e non sarà vincolante per il Venditore se non espressamente accettato per iscritto dal rappresentante autorizzato del Venditore con specifico riferimento a tali termini.

### 1. Definizioni

- 1.1 Nei presenti Termini e Condizioni generali, i seguenti termini e frasi avranno i seguenti significati:

**Contratto:** indica un Ordine di Acquisto, unitamente ai presenti Termini e Condizioni generali.

**Legge Applicabile:** indica qualsiasi legge, statuto, ordine, decreto, norma, ingiunzione, licenza, permesso, consenso, approvazione, accordo, regolamento, interpretazione, trattato, sentenza o azione legislativa o amministrativa di un'autorità governativa competente, che si applica alla fornitura o alla prestazione di Prodotti e/o Servizi.

**Cliente:** ha il significato attribuito in premessa.

**Prodotti pre- Fabbricati** indica i Prodotti prefabbricati o assemblati in conformità con una specifica fornita dal Cliente.

**Prodotti:** indica beni, materiali e altri oggetti fisici che il Venditore ha accettato di fornire al Cliente ai sensi del Contratto.

**Ordine di Acquisto:** indica l'ordine del Cliente per i Prodotti o i Servizi presentati in conformità all'articolo 2.

**Venditore:** ha il significato attribuito in premessa.

**Servizi:** indica i servizi (inclusi i servizi digitali) che il Venditore ha accettato di prestare per il Cliente ai sensi del Contratto.

**Termini e Condizioni:** ha il significato attribuito in premessa.

#### 1.2 Interpretazione. Nel Contratto,

- Il riferimento a una persona comprende persone fisiche, società o entità prive di personalità giuridica (con o senza personalità giuridica distinta).
- Un riferimento a una parte include i suoi successori e cessionari autorizzati.
- Un riferimento a una normativa o a una disposizione legislativa costituisce un riferimento alla stessa e successive modifiche o revisioni. Un riferimento a una normativa o a una disposizione legislativa include tutta la legislazione subordinata prevista da tale legislazione o disposizione legislativa.
- Qualsiasi dicitura successiva ai termini, compresi includere, in particolare, per esempio o qualsiasi espressione simile, deve essere interpretata come illustrativa e non deve limitare il senso delle parole, della descrizione, della definizione, della frase o del termine che precede tali termini.
- Un riferimento a scritto o per iscritto include fax e email.
- L'introduzione e l'appendice costituiranno parte dei presenti Termini e Condizioni generali.

- 1.3 Disposizioni specifiche per Paese. Le disposizioni specifiche per Paese di cui all'Allegato 1 sono incluse nei presenti Termini e Condizioni generali. In caso di conflitto tra un termine presente in un Ordine di Acquisto, le disposizioni specifiche per paese e le presenti Condizioni generali, prevarrà il termine nel documento citato per la prima volta. In caso di conflitto tra un termine tradotto in un Ordine di Acquisto, le disposizioni specifiche per Paese o i presenti Termini e Condizioni generali e l'equivalente in inglese, prevarrà l'equivalente in lingua inglese.

### 2. Ordini di acquisto

- 2.1 Termini. I presenti Termini e Condizioni generali si applicano a ciascun Ordine di Acquisto. Qualsiasi termine aggiuntivo o diverso proposto dal Cliente (inclusi termini e condizioni generali di acquisto da parte del Cliente) che il Cliente cerca di imporre o incorporare sono espressamente rifiutati, indipendentemente dal fatto che il Cliente si riferisca a tali termini in una richiesta di preventivo, altra comunicazione indirizzata al Venditore o altro, e non sarà vincolante per il Venditore se non espressamente accettato per iscritto dal rappresentante autorizzato del Venditore con riferimento specifico alla presente clausola.

- 2.2 Ordini di acquisto. Il Cliente può presentare ordini di acquisto per Prodotti e Servizi al Venditore. Ogni Ordine di acquisto sarà considerato un'offerta separata del Cliente di acquistare Prodotti o Servizi ai sensi del presente Accordo, che il Venditore ha il diritto di accettare o rifiutare a sua discrezione, anche se un preventivo del Venditore è seguito da un Ordine di acquisto da parte del Cliente. Si concorda un Ordine di Acquisto, e si stipula un Accordo, solo al verificarsi della prima delle seguenti circostanze: (a) il Venditore conferma per iscritto un Ordine di Acquisto emesso dal Cliente, o (b) il Venditore inizia l'esecuzione di tale Ordine di Acquisto. Fatto salvo quanto sopra, il Venditore può chiedere al Cliente di ordinare una quantità minima o valore di ordine dei Prodotti per Ordine di acquisto.

- 2.3 Modifiche, dettagli, NCNR. Gli Ordini di acquisto non possono essere modificati, annullati o riprogrammati senza il previo consenso scritto del Venditore. Tutti gli Ordini di acquisto devono essere forniti per iscritto e devono indicare i Prodotti e i Servizi, le quantità di unità, i numeri parziali, i prezzi applicabili e le date di consegna richieste dei Prodotti o dei Servizi acquistati. Il venditore può designare alcuni prodotti e servizi come non annullabili e non restituibili ("NCNR") a sua discrezione, e la vendita di tali prodotti sarà soggetta a qualsiasi termine e condizione speciale contenuta nella conferma del venditore a un ordine di acquisto o a una lettera NCNR (come applicabile), che prevarrà e sostituirà qualsiasi termine e condizione incoerente contenuta qui o altrove. A meno che il Cliente non rifiuti

prontamente tali termini e condizioni speciali, questi saranno considerati accettati. I prodotti prefabbricati non sono annullabili e non possono essere restituiti in nessun caso.

### 3. Prezzi

- 3.1 Prezzi. Il prezzo dei Prodotti e/o dei Servizi è quello indicato nel Contratto o, se non è previsto alcun prezzo nel Contratto, il prezzo indicato nel listino prezzi pubblicato del Venditore in vigore alla data dell'Ordine di acquisto. Il Cliente deve inoltre pagare gli importi di cui al Contratto (compresi quelli di cui all'articolo 5.1 e 11 dei presenti Termini e Condizioni). Se, a seguito della conclusione del Contratto, si verifica una modifica dei prezzi delle materie prime, dei costi di manodopera o di fabbricazione, delle fluttuazioni dei cambi, degli aumenti di imposte, stipendi, imposte, premi di qualsiasi natura, imposti dal governo, il Venditore avrà il diritto di modificare unilateralmente il prezzo convenuto. Se questo diritto viene esercitato e il Venditore desidera aumentare il prezzo concordato entro tre mesi dalla conclusione del Contratto, il Cliente disporrà di due (2) settimane per risolvere il Contratto. Il Cliente non avrà il diritto ad alcun risarcimento da parte del Venditore per questo motivo. I preventivi scadranno automaticamente dopo trenta (30) giorni dalla data di emissione, o come altrimenti indicato nel preventivo. Il Cliente accetta che il Venditore possa addebitare una tassa di gestione per gli ordini di acquisto al di sotto di una quantità minima o di un valore dell'ordine, che sarà incluso nell'ordine di acquisto. Il venditore si riserva il diritto di valutare una sovrattassa per spedizione espressa per gli ordini di acquisto che devono essere spediti prima dei tempi di consegna pubblicati o concordati.
- 3.2 Obblighi di prezzo aggiuntivi. Il prezzo in un Accordo presuppone ed è subordinato all'intesa che la fornitura da parte del Venditore di qualsiasi Prodotto e/o Servizio ai sensi di tale Contratto al Cliente non sia soggetta ad alcun obbligo diretto o indiretto imposto al Venditore e/o a qualsiasi meccanismo di compensazione o partecipazione industriale o a qualsiasi altro evento che comporterebbe direttamente o indirettamente un aumento del prezzo di costo dei Prodotti e/o Servizi ("Obblighi di prezzo aggiuntivi"). Nel caso in cui vengano imposti obblighi di prezzo aggiuntivi, i prezzi, i termini e le condizioni del Contratto saranno soggetti a revisione e il Venditore si riserva il diritto di rinegoziare i prezzi, i termini e le condizioni del Contratto con il Cliente. Il Venditore non ha obblighi di fornire Prodotti e/o servizi ai sensi di un Contratto al Cliente se le Parti non sono in grado di raggiungere un ulteriore accordo su prezzi, termini e condizioni revisionati a causa di Oblighi di prezzo aggiuntive imposte.

### 4. Termini di pagamento

- 4.1 Scadenza per il pagamento. Il Venditore può fatturare al Cliente i Prodotti e i Servizi prima, durante o in qualsiasi momento dopo il completamento della consegna. Il pagamento sarà dovuto entro 30 (trenta) giorni di calendario dalla data della fattura, a meno che non venga specificato sulla fattura un periodo di tempo diverso o altrimenti comunicato per iscritto al Cliente. Le spedizioni parziali possono essere fatturate separatamente. Il Venditore può inviare le fatture in forma elettronica e non è tenuto a consegnare una copia cartacea della fattura.
- 4.2 Valuta della fattura, correzione e pagamento. I pagamenti devono essere nella valuta specificata nella fattura o come stabilito nel Contratto, e devono essere effettuati per intero e in fondi puliti tramite trasferimento elettronico di fondi su un conto bancario nominato per iscritto dal Venditore. Salvo diverso accordo scritto del Venditore, il pagamento con carta di credito non è consentito. Se il Venditore istituisce un portale di pagamento, il Cliente pagherà il Venditore attraverso detto portale, se così indicato dal Venditore. Le contestazioni relative alle fatture dovranno essere in buona fede e accompagnate da informazioni di supporto dettagliate e saranno considerate rinunciate 15 (quindici) giorni di calendario dopo la data della fattura. Il Venditore si riserva il diritto di correggere eventuali fatture imprecise. Qualsiasi fattura rettificata deve essere saldata entro la data di scadenza della fattura originale o il termine di pagamento incluso nella fattura rettificata, se successivo. Il Cliente è tenuto a pagare l'importo non contestato della fattura entro la data di scadenza della fattura originale o il termine di pagamento indicato nella fattura corretta, se successivo. Nel caso in cui vi sia un pagamento in eccesso, l'importo eccedente sarà compensato a fronte di fatture future emesse dal Venditore o altrimenti rimborsate ai termini stabiliti dal Venditore. Tutte le somme dovute ai sensi del Contratto saranno versate in toto senza alcuna compensazione, domanda riconvenzionale, detrazione o ritenuta (diversa da qualsiasi detrazione o ritenuta di imposta come richiesto dalla Legge Applicabile).
- 4.3 Ritardo nel pagamento. Se il Cliente non adempie tempestivamente i propri obblighi di pagamento nei confronti del Venditore o degli affiliati del Venditore per importi non contestati, indipendentemente dal fatto che ai sensi del Contratto o di altri contratti con il Venditore o degli affiliati del Venditore, il Venditore può, a sua esclusiva discrezione e fino a quando non siano pagati tutti gli importi insoluti e le eventuali spese in ritardo: (1) essere sollevato dai suoi obblighi in materia di garanzie, compresi, ad esempio, i tempi di consegna, il supporto per la fornitura di pezzi di ricambio e i tempi di consegna in base a qualsiasi contratto (compreso il Contratto); (2) rifiutare di elaborare qualsiasi credito a cui il Cliente può avere diritto in base a qualsiasi contratto (compreso il Contratto) (3) compensare qualsiasi credito o somma dovuta dal Venditore o da qualsiasi affiliata del Venditore al Cliente con qualsiasi importo non contestato dovuto dal Cliente al Venditore o a qualsiasi affiliata del Venditore, compresi, ma non solo, gli importi dovuti ai sensi di qualsiasi contratto (compreso il Contratto) tra le Parti o con le affiliate del Venditore; (4) trattenere le prestazioni e le spedizioni future al Cliente alle quali il Venditore o qualsiasi affiliata del Venditore è obbligato ai sensi di qualsiasi contratto (compreso il Contratto); (5) dichiarare l'inadempimento del Cliente e rescindere il Contratto e qualsiasi o tutti gli altri contratti con il Venditore o qualsiasi affiliata del Venditore; (6) rientrare in possesso dei Prodotti per

i quali non sia stato effettuato il pagamento; (7) consegnare le spedizioni future ai sensi di qualsiasi contratto (incluso il Contratto) sulla base del pagamento in contanti all'ordine o in anticipo; (8) includere spese per ritardi di pagamento sugli importi in sospeso ad un tasso del 2% al mese o il tasso massimo consentito dalla Legge Applicabile, se inferiore, per ogni mese o parte di esso; (9) addebitare spese di stoccaggio o di trasporto dell'inventario sui Prodotti; (10) recuperare tutti i costi di riscossione comprese, senza limitazione, le spese legali ragionevoli; (11) se il Cliente non adempie al pagamento in base ad un piano di rientro, accelerare tutti i pagamenti rimanenti e dichiarare il saldo totale dell'insoluto allora dovuto; (12) far sì che qualsiasi bonus di fatturato o sistema di sconti sia dovuto e pagabile solo dopo che il Cliente ha adempiuto a tutti i suoi obblighi nei confronti del Venditore; (13) richiedere al Cliente di pagare tutte le spese giudiziarie ed extragiudiziarie sostenute dal Venditore, che non saranno inferiori all'equivalente del 15% della somma in sospeso, con un importo minimo di EUR 250, o il tasso massimo consentito dalla Legge Applicabile, se inferiore; e (14) combinare uno qualsiasi dei diritti e rimedi di cui sopra come può essere consentito dalla Legge Applicabile. I rimedi di cui sopra sono in aggiunta a tutti gli altri rimedi disponibili per legge o per equità.

## 5. Consegna

- 5.1 Termini di consegna. Le parti concorderanno nell'Ordine di Acquisto i termini di consegna, incluse le modalità di consegna. Salvo diverso accordo nell'Ordine di acquisto, i termini di consegna sono i Lavori EX (Incoterm 2020), presso lo stabilimento designato del Venditore. Salvo diverso accordo scritto tra le Parti, il Cliente è responsabile dei costi di assicurazione, trasporto, trasporto, carico e scarico dei Prodotti presso il luogo di consegna, i dazi, le imposte e il completamento di tutti i documenti di autorizzazione all'esportazione. Il cliente è responsabile di tutte le spese di trasporto, dazi, tasse e altri oneri per consentire lo sdoganamento all'importazione. Il Cliente sosterrà tutti i costi di trasporto (incluse assicurazioni, tasse e dazi doganali) e il costo di eventuali reclami da depositare presso il vettore. Quando il Cliente organizza la spedizione all'esportazione, il Cliente fornirà al Venditore una prova di esportazione accettabile per le autorità fiscali e doganali competenti. I costi di imballaggio monouso sono considerati inclusi nel prezzo. Il costo dell'imballaggio riutilizzabile non è incluso nel prezzo e deve essere addebitato separatamente.
- 5.2 Spedizione. A meno che il Venditore non accetti per iscritto una data di consegna diversa, il Venditore programma la consegna in conformità con i tempi di consegna pubblicati. Tutte le date di spedizione e consegna si basano sulla disponibilità in vigore delle materie, comprese le materie prime, i programmi di produzione esistenti e il ricevimento tempestivo di tutte le informazioni necessarie. Qualsiasi data di consegna non sarà di estrema importanza per l'adempimento. Il Venditore non sarà responsabile per danni, perdite, guasti o spese derivanti da ritardi nella spedizione, anche se causati da forza maggiore o dalla mancanza del Cliente di fornire al Venditore adeguate istruzioni di consegna o altre istruzioni rilevanti per la fornitura dei Prodotti o dei Servizi. Gli ordini si considerano completati al momento della spedizione dell'importo indicato nell'Ordine di Acquisto. Salvo diverso accordo, tutti i prodotti saranno spediti entro un anno dalla data in cui il Venditore accetta l'Ordine di acquisto. Il Venditore potrà, a sua esclusiva discrezione, adempiere parzialmente a un Ordine di acquisto e allocare i Prodotti tra i propri clienti. Il Venditore effettua la consegna delle quantità di Prodotti ordinati entro i limiti delle quantità standard delle confezioni utilizzate dal Venditore di volta in volta. Se le Parti hanno convenuto per iscritto che il Venditore consegnerà i Prodotti in un cantiere, il Cliente farà in modo che i Prodotti possano essere consegnati in un punto di buona base dura più vicino al sito e il Venditore potrà rifiutare di scaricare i Prodotti su siti ritenuti inadatti dal conducente (a condizione che tale rifiuto costituisca sempre consegna dei Prodotti ai sensi del Contratto).
- 5.3 Completamento della Consegna. Salvo diverso accordo scritto delle Parti, il Cliente raccoglierà i Prodotti dagli stabilimenti del Venditore presso lo stabilimento designato del Venditore o altro luogo comunicato dal Venditore prima della consegna entro tre giorni lavorativi dal Venditore informandone il Cliente che i Prodotti sono pronti. La consegna sarà considerata completata quando i Prodotti sono consegnati in conformità con l'Incoterm convenuto o il Cliente ha fornito al Venditore una prova di consegna debitamente sottoscritta, se precedente. Al Venditore non è richiesto di consegnare quantitativi di Prodotti per i quali il Cliente non abbia fornito tempestivamente istruzioni di spedizione. Se il Cliente non adempie ad un obbligo nei confronti del Venditore, compresa la fornitura della prova di consegna, o dà al Venditore una buona ragione per presumere che il Cliente non adempirà a tali obblighi, il Venditore avrà il diritto di rientrare in possesso dei Prodotti forniti con riserva di proprietà, o di provvedere a ciò, anche se questi devono essere staccati da altri oggetti, o calcolare qualsiasi tassa aggiuntiva applicabile alla transazione specifica. Le spese del recesso sono a carico del Cliente, senza pregiudizio di qualsiasi altro diritto che il Venditore possa invocare. Inoltre, se il Cliente non accetta o non prende accordi per accettare la consegna dei Prodotti o se la consegna è ritardata dal Cliente o se il Venditore non è in grado di consegnare a causa di accesso o istruzioni inadeguate o del mancato ottenimento da parte del Cliente delle necessarie istruzioni, consensi o licenze, la consegna sarà considerata avvenuta e il Venditore potrà fare una o più delle seguenti azioni (senza pregiudizio di qualsiasi altro diritto o rimedio che il Venditore possa avere): (a) addebitare spese aggiuntive per la mancata consegna; (b) assegnare nuove date di consegna; (c) immagazzinare i Prodotti in conformità alla clausola 9; (d) fatturare al Cliente i Prodotti; (e) risolvere il Contratto senza responsabilità da parte del Venditore; e (f) recuperare dal Cliente tutti i costi e le perdite sostenuti dal Venditore.
- 5.4 Titolo e rischio di perdita. Il titolo sui Prodotti non sarà trasferito al Cliente finché il Venditore non riceve il pagamento in toto (in contanti o in fondi chiariti) per i Prodotti e altri prodotti che il Venditore ha fornito al Cliente

rispetto ai quali il pagamento è diventato dovuto. Fino a quando la proprietà dei Prodotti non sarà trasferita al Cliente, egli dovrà (i) conservare i Prodotti separatamente da tutte le altre merci detenute dal Cliente in modo che rimangano facilmente identificabili come proprietà del Venditore; (ii) mantenere i Prodotti in condizioni soddisfacenti e assicurarli contro tutti i rischi per il loro intero prezzo a partire dalla data di consegna.

Il Cliente può rivendere o utilizzare i Prodotti nel corso ordinario della sua attività (ma non diversamente) prima che il Venditore riceva il pagamento dei Prodotti. Tuttavia, se il Cliente rivende i Prodotti prima di quel momento, lo fa come committente e non come agente del Venditore; e la proprietà dei Prodotti passerà dal Venditore al Cliente immediatamente prima del momento in cui avviene la rivendita da parte del Cliente.

Il rischio di perdita passa al Cliente alla consegna ai sensi dell'articolo 5.1, tranne che per le spedizioni di esportazione, il rischio di perdita si trasferisce al Cliente al passaggio di titolo.

## 6. Resi, rimborsi e cambi

- 6.1 Resi. Solo i prodotti originariamente spediti dal venditore o da un fornitore autorizzato (drop-ship) saranno presi in considerazione per la restituzione al Venditore. I resi devono essere richiesti entro 30 giorni dalla data della spedizione, salvo un periodo più lungo sia stato concordato per iscritto dal Venditore. Se un Cliente richiede la restituzione dei Prodotti al Venditore, il Cliente certifica che i Prodotti sono stati acquistati dal Venditore e non si è verificato alcuna sostituzione del Prodotto con un altro fornitore, distributore o altra fonte del Prodotto. I resi dovranno essere posti nell'imballaggio originale, non dovranno essere stati utilizzati e in una condizione non peggiore a quella consegnata al Cliente, salvo se approvato per analisi inadempimenti/valutazione grave da parte del rappresentante di vendita del Venditore tramite un'Autorizzazione del Materiale di restituzione (RMA) o un processo equivalente applicabile. I Prodotti pre-fabbricati non possono essere restituiti o scambiati. Il Cliente dovrà restituire al Venditore tutto l'imballaggio riutilizzabile in conformità con le istruzioni del Venditore di volta in volta, a proprie spese.
- 6.2 Scambi. Qualsiasi articolo che deve essere cambiato dovrà essere nell'imballaggio originale, non dovrà essere stato utilizzato e in una condizione non peggiore a quella consegnata al Cliente. I cambi devono essere richiesti entro 30 giorni dalla data di spedizione, a meno che un periodo più lungo sia concordato dal venditore per iscritto. Gli articoli difettosi possono essere scambiati con lo stesso elemento. Gli articoli acquistati dal venditore che sono stati usati o alterati e tutti gli articoli che sono stati venduti come NC/NR non saranno accettati per lo scambio, il che include i prodotti prefabbricati.
- 6.3 Spese per il reso / tasso di reintegro scorte. Il Venditore si riserva il diritto di addebitare al Cliente le spese di annullamento e reintegro, ad un tasso minimo del 15% da detrarre dal rimborso. Il venditore non rimborsa le spese di spedizione originali. Il Cliente sosterrà tutte le spese di spedizione per resi. Il venditore non accetta spedizioni in contanti alla consegna.

## 7. Prodotti, Servizi e Garanzia

- 7.1 Prodotti e Servizi. I Prodotti del Venditore sono descritti nel catalogo prodotti del Venditore (e successive modifiche). Il Venditore ha il diritto di terminare la produzione o l'offerta di Prodotti o Servizi o modificare la specifica dei Prodotti o dei Servizi in qualsiasi momento e a sua discrezione, a condizione che il Venditore continuerà a fornire i Prodotti o i Servizi come concordato in un Ordine di acquisto.
- 7.2 Garanzia. I Prodotti del Venditore sono garantiti da difetti di materiale e di lavorazione, per un periodo di 12 (dodici) mesi dalla data di spedizione.
- 7.3 Difetti. Se il Cliente identifica un Difetto Visibile (come definito nella clausola 8.1) in un Prodotto e informa il Venditore di tale Difetto non oltre settantadue (72) ore dalla consegna e durante il periodo di garanzia applicabile stabilito nella clausola 7.2, e tale Prodotto è ritenuto difettoso dal Venditore a sua esclusiva discrezione, allora il Venditore come unico rimedio dovrà riparare o sostituire, a sua esclusiva discrezione, il Prodotto o la parte difettosa. Il venditore non sarà in nessun caso responsabile della ricerca e del reperimento dei Prodotti difettosi (ad es. aprire i muri per trovare un Prodotto difettoso) e/o dello scavo e della rimozione dei Prodotti difettosi o del ripristino degli oggetti in cui i Prodotti sono stati installati.
- 7.4 Prodotti fabbricati da terzi. I prodotti che possono essere fabbricati da un terzo e venduti dal Venditore ai sensi del Contratto non sono soggetti alle garanzie di cui al presente Contratto. Nella misura in cui il terzo conceda condizioni di garanzia al Venditore, il Venditore passerà le stesse garanzie in seguito al Cliente, se del caso.
- 7.5 Esclusione. Fatto salvo l'articolo 7.9, la garanzia di cui all'articolo 7.2 non si applica ai difetti che il Venditore determina i seguenti risultati:
- 7.6 Perdita o danno durante il trasporto;
- 7.7 Cause esterne come incidenti, abusi, uso improprio o problemi relativi alla potenza elettrica o danni agli animali;
- 7.8 Stoccaggio, manutenzione, movimentazione o installazione irragionevole o inadeguato, inclusa l'installazione diversa da quella raccomandata dal Venditore o per conto del Venditore;
- 7.9 Modifiche o riparazioni (o tentativi di apportare alterazioni o riparazioni) effettuate da una Parte diversa da una parte autorizzata;
- 7.10 Gli atti o le omissioni del Cliente che espongono l'area di installazione in cui vengono utilizzati i Prodotti o i Servizi ("Sistema") a qualsiasi ambiente non adatto ad esso, con le rispettive specifiche, compreso, senza limitazione, l'uso da parte del Cliente di liquidi e/o gas tossici, corrosivi o caustici, l'esposizione a condizioni atmosferiche severe e all'acqua;
- 7.11 Eventuali difetti o problemi causati da difetti di qualsiasi hardware o software di terzi utilizzati in combinazione con il Sistema;
- 7.12 Qualsiasi uso non conforme alla documentazione fornita dal venditore;



- 7.13 Un difetto derivante dal fatto che il Venditore ha seguito qualsiasi disegno, progetto o specifica fornita dal Cliente;
- 7.14 Una ragionevole usura; e
- 7.15 I Prodotti diversi dalla loro descrizione a seguito di modifiche apportate per garantire che rispettino la Legge Applicabile.
- 7.16 Esclusione di responsabilità. Il Venditore esclude tutte le altre garanzie, espresse o implicite, incluse garanzie di commerciabilità e idoneità per un particolare scopo e/o garanzia di non violazione. Il venditore non sarà responsabile nei confronti di alcuna parte per responsabilità oggettiva, torto, contratto o qualsiasi altro modo per i danni causati o che si sostiene siano causati come risultato di qualsiasi progetto o difetto nei prodotti del venditore. La riparazione, la sostituzione, il rimborso parziale o integrale sono l'unico ed esclusivo mezzo di rimedio a disposizione del Cliente in caso di Prodotti difettosi e le conseguenze che potrebbero derivare dallo stesso.
- 7.17 Servizi. I Servizi forniti dal Venditore non hanno l'obbligo di ottenere un risultato e il Venditore non sarà tenuto responsabile per i Servizi e eventuali imprecisioni o omissioni riguardanti disegni, consigli, dimensioni, dati tecnici, campioni, ispezioni, disegni, calcoli, consigli di calcolo e/o altra documentazione fornita dal Venditore nel contesto del Servizio sono totalmente esclusi se nessun Ordine di Acquisto corrispondente è stato stipulato con il Cliente in relazione al Servizio interessato o se i Servizi interessati sono stati forniti gratuitamente.
- 7.18 Contestazione. Il Cliente non può più invocare un difetto dei Servizi se non ha contestato per iscritto al Venditore entro sette (7) giorni dopo che il Servizio è stato eseguito dal Venditore, o se il Cliente non avesse potuto ragionevolmente scoprire il difetto del Servizio entro questo periodo, il Cliente non ha protestato per iscritto al Venditore in questo senso entro sette giorni dalla scoperta del difetto del Servizio.
- 7.19 Esclusione di responsabilità. Nonostante qualsiasi disposizione contraria del Contratto, tutti i diritti e le rivendicazioni del Cliente in relazione ai Prodotti e ai Servizi, per qualsiasi motivo, decadranno se (a) il Cliente è in ritardo nella notifica al Venditore ai sensi della presente clausola 7; (b) al Venditore non è stata data la possibilità di indagare sul merito del reclamo o di farlo indagare immediatamente sul luogo; e/o (c) in relazione ai Servizi, sono passati dodici (12) mesi dopo che il Venditore ha fornito il Servizio.
- 7.20 Indennizzo. Il Cliente risarcirà il Venditore per tutte le responsabilità, i costi, le spese, i danni e le perdite (comprese le perdite dirette, indirette o consequenziali, la perdita di profitto, la perdita di reputazione e tutti gli interessi, penali e costi e spese legali e altri costi professionali) subiti o sostenuti dal Venditore in relazione a qualsiasi reclamo presentato contro il Venditore o un membro del suo gruppo per violazione effettiva o presunta dei diritti di proprietà intellettuale di terzi derivanti da o in relazione all'uso da parte del Venditore di materiali o specifiche fornite dal Cliente al Venditore, in particolare in relazione alla prefabbricazione o all'assemblaggio dei Prodotti prefabbricati.
- 8. Reclami & ispezioni**
- 8.1 Difetti visibili. Al momento della consegna, il Cliente dovrà ispezionare i Prodotti, o fare in modo che ciò avvenga, in termini di volume, numero e difetti che possono essere stabiliti durante una normale ispezione accurata (di seguito "Difetti visibili"). In questo contesto, il Cliente si assume il rischio di effettuare un'ispezione casuale (e non completa).
- 8.2 Reclami. Eventuali reclami riguardo volume, numeri o Difetti Visibili devono essere denunciati per iscritto al Venditore immediatamente dopo la consegna e in ogni caso entro 72 ore dalla consegna. Il Cliente deve denunciare difetti diversi dai Difetti Visibili per iscritto al Venditore entro sette giorni dal loro rilevamento. La relazione deve descrivere con attenzione la natura e i motivi del reclamo.
- 8.3 CE. Se il Venditore consegna i Prodotti su presentazione di una dichiarazione di qualità o di regolamenti sul marchio CE o il suo equivalente secondo le leggi e i regolamenti applicabili, questi Prodotti saranno considerati buoni e sani, a meno che il Cliente non fornisca la prova (tecnica) del contrario.
- 8.4 Reach. Ove applicabile, il Venditore si adopererà affinché i Prodotti consegnati rispettino i requisiti del regolamento Reach (e sue successive modifiche) pubblicati su [www.echa.europa.eu](http://www.echa.europa.eu) e tutti gli obblighi derivanti dal presente regolamento Reach. Il Venditore non sarà comunque responsabile nei confronti del Cliente per qualsiasi inadempimento del Venditore o di qualsiasi altra parte nel rispettare i requisiti e tutti gli obblighi derivanti da questo regolamento Reach.
- 8.5 Esclusione di responsabilità. Tutti i diritti e le pretese del Cliente riguardanti il pagamento di una somma di denaro e/o la riparazione o la riconsegna dei Prodotti interessati e/o l'integrazione di un disavanzo, per qualsiasi motivo, nonché il diritto del Cliente di risolvere il Contratto, decadono (a) nel caso di una denuncia tardiva ai sensi dell'articolo 8.2 del presente contratto, (B) se il Venditore non ha avuto l'opportunità di verificare immediatamente la validità del reclamo in sede, o di provvedere affinché ciò sia fatto, e/o (c) se 12 (dodici) mesi sono passati dalla data di consegna.
- 9. Conservazione**
- Se il Cliente non accetta la consegna dei Prodotti, allora, fatto salvo l'articolo 5.2, e salvo che tale mancanza o ritardo sia causato da un evento di Forza Maggiore (come definito nell'articolo 14), il Venditore può immagazzinare i Prodotti fino alla consegna e addebitare al Cliente tutti i costi e le spese relative (compresa l'assicurazione).
- 10. Servizi di progettazione e Ingegneria**
- 10.1 Design. Il venditore fornirà i servizi in conformità con i requisiti di buona e valida manodopera. I Servizi si basano sulle informazioni fornite dal Cliente, per cui il Cliente garantisce l'accuratezza e la completezza degli stessi. Tutte le conseguenze di imprecisioni e/o incompletezza di tali informazioni sono interamente a carico e rischio del Cliente.
- 10.2 Servizi. I Servizi sono sempre specifici e basati sull'acquisto e
- sull'applicazione dei Prodotti realizzati e/o consegnati da o per conto del Venditore. Il Cliente non può utilizzare i Servizi forniti dal Venditore con l'applicazione di materiali di terzi, in ogni caso le conseguenze di tale corso di azione sono interamente a carico e rischio del Cliente.
- 10.3 Diritti di proprietà intellettuale. I diritti PI (come definiti nell'articolo 18) relativi ai Servizi, incluse metodologie, tecniche, documenti e altre informazioni o conoscenze associati sono e continuano ad essere acquisiti nel Venditore. Nella misura necessaria a tal fine, il Cliente otterrà una licenza non trasferibile, non esclusiva e gratuita per l'uso convenuto di questi diritti per la durata del Contratto.
- 10.4 Imposte
- 10.5 Il prezzo non include le tasse. Ad eccezione di quanto specificato nella fattura emessa dal Venditore, il prezzo del Venditore esclude tutte le imposte (incluse, a mero titolo esemplificativo ma non esaustivo, vendite, uso, accise, valore aggiunto e altre imposte analoghe), dazi e dazi (inclusi, a mero titolo esemplificativo ma non esaustivo, gli importi imposti al/i Prodotto/i o la relativa fattura di materiale ai sensi della Legge Applicabile (collettivamente, "Impostazioni").
- 10.6 Il cliente paga le Imposte. Il cliente è tenuto a pagare tutte le imposte risultanti dall'accordo o dalle prestazioni del venditore ai sensi dell'accordo, siano esse imposte, riscosse, raccolte, trattenute o valutate ora o in seguito. Se il venditore è tenuto a imporre, riscuotere, raccogliere, trattenere o valutare qualsiasi imposta su qualsiasi transazione nell'ambito dell'accordo, allora, oltre al prezzo di acquisto, il venditore fatturerà al cliente tali imposte, a meno che al momento dell'ordine, il cliente non fornisca al venditore un certificato di esenzione o altra documentazione sufficiente a verificare l'esenzione dalle imposte.
- 10.7 Trattenuta. Qualora sia necessario trattenere delle imposte dagli importi pagati o pagabili al venditore ai sensi del contratto, (a) tale importo della ritenuta non sarà dedotto dagli importi dovuti al venditore come originariamente stabilito, (b) il cliente corrisponderà le imposte per conto del venditore all'autorità fiscale pertinente in conformità alla legge applicabile, e (c) il cliente trasmetterà al venditore, entro 60 (sessanta) giorni dal pagamento, la prova delle imposte pagate sufficiente a stabilire l'importo della ritenuta e il destinatario.
- 10.8 Il Venditore non è responsabile. In nessun caso il Venditore sarà responsabile di Imposte pagate o pagabili dal Cliente. Il presente articolo sopravvivrà alla scadenza o alla risoluzione del Contratto.
- 11. Controllo delle esportazioni**
- Il Cliente conviene di rispettare tutte le leggi e i regolamenti applicabili sull'esportazione, comprese quelle degli Stati Uniti e del Regno Unito, per garantire che Prodotti, parti e tecnologie forniti dal Venditore ai sensi del Contratto non siano usati, venduti, divulgati, rilasciati, trasferiti o riesportati in violazione di tali leggi e regolamenti. Il Cliente non dovrà esportare, riesportare o trasferire, direttamente o indirettamente, alcun articolo o tecnologia forniti dal Venditore nell'ambito del Contratto a: (a) qualsiasi paese designato ai sensi della Legge Applicabile come "Stato Sponsor del Terrorismo" in qualsiasi modo descritto; (b) qualsiasi persona o entità elencata in una lista bloccata, sottoposta a embargo o proibita mantenuta da un'autorità competente ai sensi delle Leggi Applicabili; o (c) un utente finale impegnato in attività con armi nucleari, chimiche o biologiche. Se i prodotti o i servizi da esportare al di fuori degli Stati Uniti e/o dell'UE, o di altre giurisdizioni in cui le leggi richiedono dichiarazioni di "doppio uso", sono considerati o possono essere considerati "a doppio uso", il Cliente dovrà fornire (o far sì che l'utente finale dei prodotti/servizi fornisca) al Venditore, prontamente e su sua richiesta, una "Dichiarazione dell'utente finale" in conformità con i requisiti legali applicabili. Il Venditore non sarà responsabile nei confronti del Cliente per qualsiasi ritardo e non sarà in violazione dei suoi obblighi in caso di mancata o ritardata fornitura di tale dichiarazione da parte del Cliente.
- 12. Risoluzione**
- 12.1 Comunicazione di risoluzione. Ciascuna delle Parti potrà risolvere immediatamente il Contratto, dandone comunicazione scritta all'altra parte se:
- (a) L'altra parte commette una violazione sostanziale di qualsiasi termine del contratto e (se tale violazione è suscettibile di rimedio), non riesce a porre rimedio a tale violazione entro 30 (trenta) giorni di calendario dall'avviso scritto che le impone di farlo;
- (b) L'altra parte non riesce ad effettuare un pagamento richiesto dal contratto alla scadenza, e non rimedia alla violazione entro 3 giorni di calendario dal ricevimento della notifica scritta del mancato pagamento; o
- (c) Qualsiasi sospensione delle operazioni dell'altra Parte o di qualsiasi istanza presentata o procedimento presentato da o contro l'altra Parte in virtù di qualsiasi legge statale, federale o di altra Legge Applicabile relativa a accordi, riorganizzazione, amministrazione controllata o cessione a beneficio dei creditori o altri procedimenti simili.
- 12.2 Cambio controllo. Nel caso di un cambiamento diretto o indiretto nell'alta direzione o nel potere di dirigere o indurre la direzione della gestione e delle politiche del Cliente (attraverso la proprietà di azioni con diritto di voto, per contratto o in altro modo), il Venditore può rescindere immediatamente il Contratto dandone comunicazione scritta.
- 12.3 Effetto. La risoluzione non incide sui diritti e sui rimedi delle Parti maturati prima della risoluzione. I diritti di risoluzione previsti in questa clausola 13 non limitano gli altri diritti di una parte e i rimedi consentiti dalla Legge Applicabile o dall'equità. Alla risoluzione del Contratto, il Cliente, a discrezione del Venditore, restituirà al Venditore o distruggerà tutte le informazioni riservate del Venditore in suo possesso, e fornirà un certificato di un funzionario del Cliente sulla distruzione di tutte le informazioni riservate del Venditore entro 15 (quindici) giorni solari. Il Cliente non ha il diritto di usare le informazioni riservate del Venditore dopo la risoluzione dell'Accordo.

- 12.4 Sopravvivenza. Qualsiasi disposizione del Contratto che espressamente o implicitamente è destinata ad entrare o a rimanere in vigore al momento o dopo la risoluzione o la scadenza del Contratto rimarrà in pieno vigore ed effetto, comprese in ogni caso le clausole 1, 7.10, 13.3, 13.4, 16, 17, 18, 19, 20, 21, 22, 27, 28 e 29.
- 12.5 Forza maggiore/ritardo scusabile e assenza di effetti sfavorevoli
- 12.6 Forza maggiore ed altre esclusioni di responsabilità. Nessuna delle parti sarà responsabile nei confronti dell'altra, né sarà considerata in violazione o inadempienza dei propri obblighi ai sensi dell'accordo nella misura in cui l'esecuzione di tali obblighi sia ritardata o impedita, direttamente o indirettamente, per cause che sfuggono al ragionevole controllo della parte colpita, compresi, ma non solo: (a) disastri naturali o causati dall'uomo, cause di forza maggiore, atti od omissioni delle autorità governative, incendi, condizioni meteorologiche avverse, terremoti, scioperi o altre turbative del lavoro, inondazioni, rischio grave di rapimento, guerra (dichiarata o non dichiarata), conflitto armato, atti o minacce di terrorismo, pandemie, epidemie, quarantene, calamità regionali, nazionali o internazionali, disordini civili, sommosse, gravi ritardi nei trasporti, o incapacità di ottenere materiali necessari o materie prime, componenti o servizi (tutto quanto sopra definito come "Forza maggiore");(b) nel caso del Venditore, gli atti o le omissioni del Cliente, compresa la mancata fornitura tempestiva al Venditore di qualsiasi accesso, informazione, strumenti, materiale, comprese le materie prime, e le approvazioni necessarie per consentire al gruppo del Venditore di eseguire tempestivamente le attività richieste, e comprese, senza limitazione, condizioni fisiche sconosciute nel sito di natura insolita e materialmente diverse da quelle ordinariamente incontrate e generalmente riconosciute come presenti nei lavori del tipo previsto dal Contratto, si qualificheranno anche come Forza Maggiore a favore del Venditore. La Parte interessata comunicherà tempestivamente all'altra Parte in caso di ritardo ai sensi della presente clausola. Le date di consegna o di esecuzione sono prorogate per un periodo pari al tempo perso a causa di tale ritardo, più il tempo aggiuntivo eventualmente ragionevolmente necessario per superare l'effetto di tale ritardo. Se il Venditore è in ritardo a causa di atti od omissioni del Cliente, o a causa del lavoro preliminare di altri appaltatori del Cliente, il Venditore avrà anche diritto ad un equo adeguamento del prezzo. In nessun caso il cliente sarà esonerato dall'obbligo di pagamento ai sensi della presente clausola. Il Cliente inoltre dichiara e riconosce che la sua esperienza e/o capacità sono tali da adempiere ai propri obblighi anche nei casi di Forza Maggiore nella massima misura possibile e per quanto consentito dalla Legge Applicabile.
- 12.7 Diritto di Risoluzione. Se un ritardo derivante dalle circostanze di cui alla presente clausola 14 si estende per più di 90 (novanta) giorni e le Parti non hanno concordato una base rivista per la ripresa del lavoro, che può includere un equo adeguamento del prezzo, allora una delle Parti (tranne quando tale ritardo è causato dal Cliente, nel qual caso solo il Venditore), con un preavviso scritto di 30 (trenta) giorni, può risolvere il Contratto. In tale caso di ritardo, il Cliente corrisponderà al Venditore il prezzo proporzionale per tutti i lavori e gli impegni eseguiti prima della data effettiva di risoluzione.
- 13. Salute e sicurezza ambientale (EHS)**
- 13.1 Il cliente è tenuto a fornire un ambiente di lavoro sicuro. Il Cliente adotterà tutte le azioni necessarie per fornire un ambiente di lavoro sicuro e sano, inclusi trasporti e alloggio, se applicabile, per il personale del Venditore. Il cliente informerà il venditore di tutti i rischi noti, dei pericoli o delle condizioni modificate che hanno un impatto sulla salute dei lavoratori, sulla sicurezza o sull'ambiente, compresa la presenza o la potenziale presenza di materiali pericolosi, e fornirà le informazioni pertinenti, comprese le schede di sicurezza, i piani di sicurezza del sito, le valutazioni dei rischi e le analisi dei rischi sul lavoro.
- 13.2 Il cliente è tenuto a fornire al venditore l'accesso al luogo di lavoro e la notifica delle leggi applicabili. Per valutare i rischi associati alla fornitura di servizi e alle prestazioni ai sensi del Contratto, il Cliente fornirà al Venditore un accesso ragionevole per esaminare il sito e le relative attrezzature. Se il lavoro del Venditore nel sito è soggetto a requisiti legali locali, statali o nazionali non ragionevolmente disponibili, il Cliente ne informerà il Venditore e ne fornirà copie.
- 14. Limitazioni di responsabilità**
- 14.1 Perdite speciali o consequenziali. I rimedi di cui al presente contratto costituiscono l'unico ed esclusivo rimedio del cliente (incluse le pretese di terzi. Il venditore non risponde nei confronti del cliente per danni indiretti o conseguenti di qualsiasi natura quali (ma non limitatamente): ritardi, danni dovuti all'interruzione dell'attività, perdite di profitto, risparmi perduti, perdite di reddito, opportunità perse, perdita di avviamento, perdita di dati danni alla reputazione o sanzioni o multe espropriate.
- 14.2 Totale responsabilità: La responsabilità totale del venditore ai sensi o in relazione al contratto per pretese derivanti dall'esecuzione/inadempimento o violazione del contratto, incluso qualsiasi altro risarcimento ai sensi del contratto, o la fornitura di prodotti e servizi non deve superare l'importo pagato o pagabile per lo specifico prodotto o servizio che da luogo alla richiesta di risarcimento.
- 14.3 Comportamento doloso o negligenza grave. Le limitazioni od esclusioni di cui sopra nella presente clausola si applicheranno solo nella misura consentita dalla legge obbligatoria applicabile e non si applicheranno in caso di intenzione o dolo o colpa grave del venditore o della sua gestione.

## 15. Indennità

Il Cliente solleverà, difenderà, indennizzerà e manleverà il Venditore, le affiliate del Venditore e ciascuno dei rispettivi funzionari, amministratori, dirigenti, dipendenti, rappresentanti e consulenti (i **Beneficiari del Venditore**) da e contro qualsiasi responsabilità, perdita, danno, reclamo, multa, sanzione, giudizio, transazione,

costo e spesa (incluse le spese legali), incluse le lesioni personali o la morte dei dipendenti del Cliente o i danni alla proprietà, derivanti da o in relazione al Contratto e alle attività del Cliente in relazione al Contratto, compresi (a) la manipolazione, lo stoccaggio, la commercializzazione, la vendita, la rivendita, la distribuzione, l'uso o lo smaltimento dei Prodotti o dei Servizi (utilizzati da soli o in combinazione con altre sostanze) da parte del Cliente o di terzi presso gli impianti del Cliente o di terzi in qualsiasi luogo o (b) il mancato rispetto da parte del Cliente di qualsiasi istruzione o regolamento relativo alla sicurezza (del prodotto) o alla Legge Applicabile. La presente clausola sopravvivrà alla scadenza, risoluzione o risoluzione del Contratto.

## 16. Diritti PI del Venditore

I diritti di proprietà intellettuale del Venditore includono, senza limitazione, tutti i marchi, i nomi commerciali, i loghi, i disegni, i simboli, gli emblemi, i marchi distintivi, i marchi di servizio, i marchi di servizio, i brevetti, i modelli, i disegni, il know-how, le informazioni e qualsiasi altro materiale distintivo del Venditore, del Gruppo del Venditore e del Gruppo Orbia, indipendentemente dal fatto che siano o meno soggetti a registrazione o deposito, incluse tutte le registrazioni e le domande di registrazione di una delle voci precedenti; e tutti i diritti in natura di una delle precedenti voci e tutti i diritti di effetto equivalente o simile a, nonché il diritto di chiedere per uno qualsiasi dei diritti di cui alla presente definizione in qualsiasi giurisdizione (di seguito "**Diritti PI**"). Il Venditore conserva tutti i Diritti PI sui Prodotti e i Servizi, e nulla nel presente documento potrà essere interpretato in modo da concedere al Cliente diritti o licenze, espressi o impliciti, sui Diritti PI del Venditore. In particolare, il Cliente non utilizzerà il nome, il logo o altri Diritti PI del Venditore senza il suo previo consenso scritto. Inoltre, il Cliente non farà o mancherà di fare nulla che possa infrangere, danneggiare, mettere in pericolo o compromettere i Diritti PI del Venditore. In particolare, il Cliente non dovrà: (a) modificare, rimuovere o deturpare qualsiasi contrassegno o altro mezzo di identificazione dei Prodotti o dei Servizi forniti dal Venditore; (b) utilizzare i Diritti di proprietà intellettuale del Venditore in modo tale che il loro carattere distintivo o la loro validità possano essere compromessi; (c) utilizzare marchi diversi da quelli del Venditore in relazione ai Prodotti o ai Servizi forniti dal Venditore senza il preventivo consenso scritto del Venditore, o (d) utilizzare marchi o nomi commerciali simili ai marchi o ai nomi commerciali del Venditore che possano causare confusione o inganno. Ai fini del presente documento "**Gruppo Venditore**" si riferisce a Wavin B.V. le sue filiali e il gruppo di società, e il Gruppo Orbia si riferisce a Orbia Advance Corporation, S.A.B. de C.V. e le sue filiali e il gruppo di società.

## 17. Riservatezza dei dati

Ciascuna Parte rispetterà tutte le leggi sulla protezione dei dati applicabili. Salvo diverso accordo tra le Parti, il Venditore (o i suoi subappaltatori) non tratterà informazioni relative a persone fisiche identificate o identificabili ("**Dati personali**") per il Cliente o per conto del Cliente. Nel caso in cui il Venditore tratti i Dati personali nell'ambito dei propri scopi commerciali legittimi, lo farà in conformità con l'Informativa sulla privacy del Venditore consultabile su <https://www.wavin.it/it-it/privacy-policy-and-cookies>.

## 18. Riservatezza

"**Informazioni riservate**" indica i termini del Contratto e tutte le informazioni non pubbliche, i dati tecnici o il know-how in qualsiasi forma e i materiali (inclusi i campioni) riguardanti il business, i prodotti, i servizi e/o le attività del Venditore e/o dei suoi affiliati divulgati o resi disponibili al Cliente in relazione al Contratto, sia oralmente che per iscritto, in forma elettronica o di altro tipo, e contrassegnati o meno come proprietari o riservati, e qualsiasi informazione derivata dalle Informazioni riservate; purché le informazioni riservate non includano informazioni (i) note al Cliente al momento della divulgazione o legittimamente ottenute dal Cliente su base non riservata da una terza parte; (ii) che sono ora o diventeranno in seguito, senza che il Cliente abbia agito o ommesso di agire, generalmente note al pubblico; o (iii) che sono sviluppate indipendentemente dal Cliente senza fare affidamento sulle informazioni riservate, in ogni caso come dimostrato da prove documentali contemporanee. Il Cliente non dovrà utilizzare le Informazioni Riservate se non al fine di esercitare i propri diritti o adempiere le proprie obbligazioni ai sensi del Contratto (la "**Finalità**"). Il Cliente non dovrà divulgare le Informazioni Riservate a terzi, ad eccezione dei propri dipendenti e agenti che abbiano la necessità di conoscere tali informazioni per la finalità e che siano vincolati da obblighi di non divulgazione scritti almeno quanto quelli contenuti nel Contratto. Il Cliente non potrà decodificare le Informazioni Riservate, inclusi i campioni, senza il permesso del Venditore. Il cliente adotterà misure di sicurezza ragionevoli e prudenti per impedire l'uso o la divulgazione di informazioni riservate in violazione del presente documento. Il cliente sarà responsabile degli obblighi dei propri dipendenti e agenti ai sensi del contratto e si assumerà la responsabilità per i danni derivanti da qualsiasi violazione del presente accordo da parte dei suoi dipendenti e agenti, che sarebbe una violazione del presente accordo se commessa direttamente dal cliente, compreso, senza limitazione, l'uso non autorizzato delle informazioni riservate. Su richiesta del Venditore, il Cliente dovrà prontamente restituire tutte le copie, scritte, elettroniche o di altro tipo, di dette Informazioni Riservate, o cancellare e distruggere le Informazioni riservate in modo sicuro. Nonostante quanto sopra, il Cliente può conservare una copia delle Informazioni Riservate per finalità di gestione delle registrazioni o copie in sistemi di back-up di archiviazione a livello aziendale. Nonostante la distruzione o la conservazione delle Informazioni Riservate, il Cliente continuerà ad essere vincolato ai propri obblighi di riservatezza ai sensi del presente contratto. Nel caso in cui il Cliente sia tenuto a divulgare le Informazioni Riservate per ordine di un tribunale o di un'agenzia governativa, per legge, regolamento, procedimento giudiziario o amministrativo, il Cliente dovrà: (a) dare preventivamente comunicazione scritta al Venditore, se legalmente consentito; (b) collaborare ragionevolmente con il Venditore, su richiesta e spese del Venditore, per resistere o limitare tale divulgazione o ottenere un ordine di tutela; e (c) in assenza di un provvedimento cautelare o di altro rimedio, divulgare soltanto quella parte delle Informazioni Riservate che è legalmente tenuta a essere divulgata a giudizio del consulente e garantisce che il trattamento riservato sarà accordato alle informazioni divulgate. A seguito della risoluzione, gli obblighi del Cliente ai sensi del presente contratto rispetto alle Informazioni Riservate resteranno

pienamente validi ed efficaci come segue: (i) nel caso di Informazioni Riservate che costituiscono un segreto commerciale ai sensi della Legge Applicabile, per tutto il tempo in cui dette informazioni rimangono segreto commerciale; o (ii) nel caso di altre Informazioni Riservate o materiali, per un periodo di cinque (5) anni dalla data di divulgazione. Il Venditore ha diritto a un risarcimento ingiuntivo per violazioni o minacciate violazioni della presente disposizione senza l'obbligo di pubblicare obbligazioni o provare danni.

#### 19. Dati clienti

- 19.1 Il cliente è proprietario dei dati del cliente e il venditore ha concesso la licenza. Il Venditore riconosce che, come tra Venditore e Cliente, il Cliente possiede tutti i diritti, titoli e interessi, inclusi tutti i diritti di proprietà intellettuale, nei e nei Dati del Cliente (come definito di seguito). Con il presente documento il Cliente concede al Venditore (i) una licenza non esclusiva, perpetua, irrevocabile, esente da royalty, interamente saldata, in tutto il mondo, per riprodurre, distribuire, modificare e utilizzare e visualizzare in altro modo i Dati del Cliente per scopi di ricerca interna e sviluppo di prodotti/servizi e per fornire Prodotti e Servizi al Cliente, e (ii) una licenza non esclusiva, perpetua, irrevocabile, esente da royalty, interamente saldata, in tutto il mondo, per riprodurre, distribuire, modificare e utilizzare e visualizzare in altro modo i Dati del Cliente incorporati nelle statistiche aggregate. "Dati del cliente" indica, ad eccezione delle statistiche aggregate, le informazioni, i dati e altri contenuti, in qualsiasi forma o mezzo, che sono inviati, pubblicati o altrimenti trasmessi o resi disponibili da o per conto del Cliente, o da un utente del Prodotto o dei Servizi del Cliente che incorporano il prodotto o i servizi oggetto del Contratto, al Venditore che sono generati dal Prodotto o dal Servizio o dall'uso del Prodotto o del Servizio, a condizione che i Dati del cliente escludano qualsiasi Dato personale. Nulla nel Contratto deve essere considerato come una limitazione dei diritti concessi dal Cliente al Venditore in qualsiasi altro contratto.
- 19.2 Feedback del Cliente Se il Cliente o un o dei suoi dipendenti o collaboratori suggerisce o raccomanda modifiche al Prodotto o ai Servizi, comprese, senza limitazione, nuove caratteristiche o funzionalità relative ad essi, o condivide commenti, domande, suggerimenti o simili ("Feedback"), il Venditore sarà libero di utilizzare tale Feedback a prescindere da qualsiasi altro obbligo o limitazione tra le Parti che disciplina tale Feedback. Con il presente documento il Cliente trasferisce al Venditore per conto del Cliente, e per conto dei suoi dipendenti, appaltatori e/o agenti, tutti i diritti, i titoli e gli interessi in e verso il Feedback e il Venditore è libero di utilizzare, senza alcuna attribuzione o compensazione a qualsiasi parte, qualsiasi idea, know-how, concetto, tecnica o altri diritti di proprietà intellettuale contenuti nel Feedback, per qualsiasi scopo, sebbene il Venditore non sia tenuto a utilizzare alcun Feedback.

#### 20. Dati statistici aggregati.

Nonostante quanto diversamente stabilito nel Contratto o in qualsiasi altro accordo di non divulgazione tra le Parti, il Venditore può monitorare l'uso del Prodotto o dei Servizi da parte del Cliente e raccogliere e compilare statistiche aggregate (come definito di seguito). Nel rapporto tra il venditore e il cliente, tutti i diritti, i titoli e gli interessi nelle statistiche aggregate, e tutti i diritti di proprietà intellettuale in esse contenute, appartengono e sono conservati esclusivamente dal venditore. Il Cliente è consapevole che il Venditore può compilare statistiche aggregate basate sui Dati del Cliente raccolti dall'uso del Prodotto o dei Servizi da parte del Cliente (o dei suoi clienti). Il Cliente accetta che il Venditore possa (i) rendere disponibili al pubblico le Statistiche Aggregate in conformità alla Legge Applicabile e (ii) utilizzarle nella misura e nel modo consentito dalla Legge Applicabile, a condizione che tali Statistiche Aggregate non identifichino espressamente il Cliente. "Statistiche aggregate" indica i dati e le informazioni relative all'uso del Prodotto o dei Servizi da parte del Cliente (o dei suoi clienti) che vengono utilizzati dal Venditore in forma aggregata e non identificano direttamente il Cliente, anche per compilare informazioni statistiche e sulle prestazioni relative alla fornitura e al funzionamento del Prodotto e dei Servizi del Venditore.

#### 21. Rispetto della legge applicabile

- 21.1 Standard del settore Il Contratto si basa sulla progettazione, la fabbricazione, il collaudo e la consegna dei Prodotti e dei Servizi da parte del Venditore conformemente a: (i) ai propri criteri di progettazione, processi e procedure di produzione e al programma di garanzia della qualità; (ii) a quelle parti di specifiche, codici e standard industriali in vigore alla data di stipula del Contratto come specificato al Venditore; (iii) alla Legge Applicabile; e (iv) a qualsiasi termine e specifica scritta concordata reciprocamente e stabilita nel Contratto. Se qualsiasi dei suddetti elementi dovesse cambiare, il Venditore può modificare unilateralmente i Prodotti e i Servizi per garantire la conformità con quanto affermato in precedenza. Inoltre, il Venditore ha il diritto di modificare unilateralmente il prezzo convenuto, la data di consegna/realizzazione o le garanzie. Nel caso in cui tale modifica impedisca al Venditore di eseguire le proprie obbligazioni senza violazione della Legge Applicabile o di rendere ingiustamente onerosa o sbilanciata l'esecuzione da parte del Venditore delle sue obbligazioni, il Venditore avrà altresì il diritto di risolvere il Contratto senza alcuna responsabilità.
- 21.2 Conformità alla Legge Applicabile A prescindere da qualsiasi altra disposizione del contratto, le parti sono tenute in ogni momento a rispettare tutte le leggi applicabili nell'esecuzione del contratto.
- 21.3 Clausola anti-concussione e anti-corruzione. Il Cliente garantirà che lui, i suoi direttori, dipendenti o subappaltatori non offriranno, prometteranno o concederanno alcun indebito vantaggio pecuniario o di altro tipo ai dipendenti del Venditore o a terzi (compresi i dipendenti pubblici) al fine di ottenere o mantenere un vantaggio commerciale o altro vantaggio improprio, in relazione al Contratto. Il Cliente rispetterà tutte le legislazioni anticorruzione applicabili (incluse, ma non solo, la US Foreign Corrupt Practices Act e la UK Bribery Act) e avrà messo in atto adeguate misure

preventive per garantire che i dipendenti e i subappaltatori rispettino la legislazione applicabile.

#### 22. Cessione, novazione e subappalto

Il Cliente non può cedere o novare il Contratto, in tutto o in parte, anche attraverso il cambiamento della struttura o della proprietà del Cliente, senza il previo consenso scritto del Venditore, che non sarà irragionevolmente ritardato o negato, a condizione che il Venditore abbia il diritto di negare tale consenso in ogni caso se il cessionario/novatario non ha un'adeguata capacità finanziaria, è un concorrente o un potenziale concorrente del Venditore o delle sue affiliate, fa sì che il gruppo del Venditore sia in violazione della legge applicabile e/o non rispetta il codice etico del Venditore. Il Venditore può cedere o novare a terzi il Contratto, in tutto o in parte e, in tal caso, il Venditore ne darà comunicazione scritta al Cliente. Le Parti convengono di sottoscrivere i documenti eventualmente necessari per dare effetto alle cessioni o novazioni consentite di cui alla presente clausola. In caso di novazione o cessione da parte del Cliente, il Cliente farà in modo che il creditore delegatario/assegnatario fornisca ulteriori garanzie di pagamento su ragionevole richiesta del Venditore. Qualsiasi cessione o novazione in violazione di quanto sopra sarà nulla e senza effetto per le parti.

#### 23. Subappaltatori

Il Venditore ha il diritto di subappaltare i propri obblighi ai sensi del presente Contratto. L'uso di un subappaltatore non esonera il Venditore dalla responsabilità ai sensi del presente Contratto per l'esecuzione degli obblighi in subappalto.

#### 24. Modifiche

Ciascuna Parte potrà in qualsiasi momento proporre modifiche al Contratto sotto forma di ordine di modifica. Nessuna delle Parti è obbligata a procedere con l'ordine di modifica finché entrambe le Parti non accettano tale modifica per iscritto. Se non diversamente concordato dalle parti, i prezzi per il lavoro aggiuntivo derivante da tali modifiche saranno al tempo del venditore e alle tariffe dei materiali in quel momento.

#### 25. Legge applicabile

Il contratto sarà regolato e interpretato in conformità con le leggi della giurisdizione in cui il venditore è registrato, escludendo in ogni caso il conflitto di norme di legge. Le parti riconoscono e concordano che l'applicabilità della Convenzione delle Nazioni Unite sui contratti di vendita internazionale di beni (spesso indicata come la Convenzione di Vienna sulle vendite) viene espressamente esclusa.

#### 26. Risoluzione delle controversie

Qualsiasi controversia o reclamo derivante da o in relazione al Contratto o al suo oggetto o alla sua formazione (comprese le controversie o i reclami extracontrattuali) sarà soggetto alla giurisdizione esclusiva dei tribunali competenti nella giurisdizione e nel distretto in cui il Venditore è incorporato e le Parti si sottopongono irrevocabilmente alla giurisdizione esclusiva di tali tribunali per questi scopi.

#### 27. Clausole Generali

- 27.1 Contratto indivisibile Questo contratto rappresenta l'intero accordo tra le parti e sostituisce ed estingue tutti i precedenti contratti, promesse, assicurazioni, garanzie, rappresentazioni e intese tra loro, sia scritte che orali, relative al suo oggetto. Eventuali precedenti contratti conclusi tra le Parti sono sostituiti dal presente Contratto.
- 27.2 Nessuna modifica orale. Nessuna modifica, alterazione, risoluzione, rinuncia o altro cambiamento sarà vincolante per entrambe le parti se non concordato per iscritto dai loro rappresentanti autorizzati. Ciascuna parte accetta di non aver fatto affidamento o di essere stata indotta da alcuna dichiarazione dell'altra parte non contenuta nel presente contratto.
- 27.3 Clausola salvatoria. L'invalidità in tutto o in parte del Contratto non pregiudica la validità del resto del Contratto. Nel caso in cui una disposizione del Contratto sia ritenuta non valida o inapplicabile, solo la parte non valida o inapplicabile della disposizione sarà eliminata, lasciando intatta e in vigore il resto della frase, della clausola e della disposizione nella misura in cui non sia ritenuta nulla o non applicabile.
- 27.4 Titoli. I titoli delle clausole e dei paragrafi del presente documento sono solo per riferimento e non influiscono sul significato o sull'interpretazione di qualsiasi disposizione dell'accordo.

Ai sensi degli articoli 1341 e 1342 del codice civile italiano, il Cliente dichiara di aver letto, compreso ed espressamente accettato le seguenti sezioni: Articoli 4.3 (Ritardo di pagamento), 16 (Limitazione di responsabilità), 17 (Indennità), 24 (Cessione, novazione e subappalto) 27 (Legge applicabile) e 28 (Risoluzione delle controversie). Ai fini del presente documento "Gruppo Venditore" si riferisce a Wavin B.V. le sue filiali e il gruppo di società, e il Gruppo Orbia si riferisce a Orbia Advance Corporation, S.A.B. de C.V. e le sue filiali e il gruppo di società.

#### Contributo Polieco

Sulla base del decreto ministeriale del 23 maggio 2019, pubblicato sulla Gazzetta Ufficiale l'11 luglio 2019, per legge ed in particolare ai sensi e per gli effetti dell'articolo 234 del d.lgs. 152/2006, tutti i beni in polietilene destinati al territorio nazionale, ove per "bene in polietilene si intende qualsiasi manufatto immesso sul mercato nazionale realizzato in polietilene in tutto o in parte a prescindere dalla quota di polietilene presente" (cit. Consorzio Polieco), sono oggetto di contributo e dichiarazione periodica.

#### Wavin Italia Spa

Indirizzo Via Boccalara 24 - 45030 S. Maria Maddalena - Rovigo -Italia  
Telefono: +39 0425 758811  
Internet: www.wavin.it  
E-mail: info.it@wavin.com









# Scopri la nostra gamma prodotti su wavin.it



- Sistemi di Adduzione acqua e gas
- Sistemi di Scarico acque reflue
- Climatizzazione Radiante
- Ventilazione Meccanica Controllata
- Controlli
- Gestione acque meteoriche



Wavin è parte di Orbia, una comunità di aziende che lavorano insieme per affrontare alcune delle sfide più complesse del mondo.

Siamo uniti da un obiettivo comune:

To Advance Life Around the World.

2023 Wavin Italia S.p.A. | Via Boccalara, 24 | 45030 S. Maria Maddalena | Rovigo | Tel. +39 0425 758811 | [www.wavin.it](http://www.wavin.it) | [info.it@wavin.com](mailto:info.it@wavin.com)

Wavin opera un programma di continuo sviluppo dei propri prodotti e si riserva quindi il diritto di modificare o correggere le specifiche dei propri prodotti senza alcun preavviso. Tutte le informazioni contenute in questa pubblicazione sono fornite in buona fede e ritenute corrette al momento della stampa. Tuttavia, nessuna responsabilità può essere accettata per eventuali errori, omissioni o errate considerazioni.

© 2023 Wavin Italia S.p.A. Wavin si riserva il diritto di apportare modifiche senza preavviso.

Grazie al continuo sviluppo dei prodotti possono essere apportati cambiamenti alle specifiche tecniche. L'installazione deve essere eseguita seguendo le istruzioni d'installazione.