

Product guide

# Wavin PP-R and PP-RCT Pipe Systems

Hot and Cold Water Systems  
and Heating Applications









Wavin is one of the leading companies in the plastic pipe industry in Turkey. Our company offers a wide range of high-quality pipe and fittings system solutions for building and infrastructure. Our company, which has a history of more than half a century, started production in 1971 in Adana. Pilsa Plastik A.Ş. was purchased by Wavin B.V, the largest European company in its own field in the Netherlands in 2008.

In 2012, all Wavin companies joined the Mexichem family which is South America's giant petrochemicals and raw materials producer. Mexichem announced its new name as ORBIA in 2019. ORBIA, with its new changing business structure, provides professional support to its customers with its products and services in 5 main business lines: Building & Infrastructure, Flour, Datacom, Precision Agriculture and Polymer Solutions. With the new structuring of ORBIA, its main mission is to advance life around the world.

In 2019, with the renewed business structure of ORBIA, building & infrastructure business line was started to represent by WAVIN, a single and strong brand across the globe. WAVIN operates in more than 40 countries around the world in 4 main regions: Europe-Middle East-Africa, Asia-Pacific, Latin America and USA-Canada with 12.000 employees.

Wavin is now a global leader in the supply of plastic pipe systems and solutions for both above and below ground applications in projects around the world. Since the 1950s, we have built an unrivalled reputation for continuous innovation, intelligent problem-solving, dedicated technical support and the highest standards.

Wavin Turkey offers traditional products such as PPR-C clean water, PVC wastewater as well as the innovative products such as Tigris Press-fit systems, Sentio underfloor heating control, SiTech+ low noise pipes, Qickstream siphonic rainwater drainage systems, Q-Bic Plus infiltration systems, Tegra plastic manholes etc. to the sector. Wavin Academy which is the first training centre of the sector was opened in 2014 within our factory in Adana, Tens of thousands of visitors from various levels of the mechanical installation sector have been able to increase their expertise by attending training at Wavin Academy since 2014. Our company provides fast service with Adana, Istanbul, Ankara and Izmir offices, distribution centres located in Istanbul and Adana and wide dealers network. In addition to our sales staff, our expert engineers and technical personnel support our customers for the projects.

To get more information about our company and products, please visit our website [www.wavin.com.tr](http://www.wavin.com.tr) and follow us on our social media accounts.



## Building Healthy, Sustainable Environments

Our purpose is “Building Healthy, Sustainable Environments” as Wavin in global. To reach that goal one first driver is “Safe and Efficient Water Supply”. We care human health and this is the way how we manage our product portfolio.



PPR Pipes and Fittings used in several applications like potable water, heating and cooling or industrial applications. The PPR system basically based on pipes, full plastic fittings, fittings with inserts, valves and tools.



According to the European drinking water directive and hygienic assessment of materials in contact with drinking water, nickel coating is no more applicable for tap water installations. That is why we removed nickel coating from our PPR fittings with metal inserts which are used in drinking water applications globally.

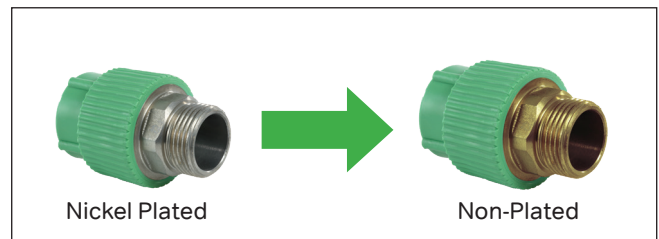

The new PPR Fittings are non-coated brass alloy which is in the acceptable alloy list in 8th revision of 4MS 2017. Metal deactivators are used in the recipe in order to avoid any damage on plastic parts that may be caused by free metal ions from inserts. This application is valid for every color of fitting. PPR Fittings will continue to meet all performance requirements of EN ISO 15874-3 standard. You can reach to international product certifications via Wavin representative.



## Extensive Product Range

### Above Ground Product Groups:

- PPR&PP-RCT Pipes & Fittings and Composite PPR & PP-RCT Pipes
- PEX and Pert Pipes - Protected PEX and Pert Pipes and Fittings
- OXY PEX and Pert Pipes - Protected OXY PEX and Pert Pipes
- Underfloor Heating and Sentio control systems
- Tigris Press Fitting Systems
- Wavin AS+, SiTech+ and SiTech B1 low noise systems
- Wavin Quickstream Siphonic Roof Drainage System
- U-PVC Soil and Waste System
- HepVO Waterless Trap

### Below Ground Product Groups:

- U-PVC Pressure Pipes & Fittings
- PE Pipes (LDPE & HDPE)
- Wavin PE Fittings (Electrofusion - Spigot)
- Wavin Plastic Manholes (Inspection Chambers) & Fittings
- Apollo O-PVC Pressure Pipes
- Separators
- Road Gullies
- Aquacell ve Qbic plus attenuation and infiltration tanks



## Why Would You Collaborate With Wavin Turkey?

Wavin Turkey provides the best quality as one of the market leader and:

- ▶ Uses the most appropriate raw material,
- ▶ Has the most advanced high technology,
- ▶ Produces pipes in compliance with Turkish (TS), European (EN) and German(DIN) Standards,
- ▶ Produces pipes not only for water management but also a wide range of fluids.
- ▶ Has qualified technical staff in order to solve your problems.
- ▶ Stands for quality.

## Why Would You Prefer Wavin Pipes?

Wavin has got the following advantages:

- ▶ Not dangerous for human life, non-toxic, non-cancerous,
- ▶ Low cost of transportation; loading and unloading
- ▶ Has much longer service life compared to other piping systems,
- ▶ Has high resistance against corrosion,
- ▶ Can easily be connected to any kind of pipe. Due to low cost of plumbing, it has a wide range of applications,
- ▶ Water is one of the most important essential contributing to human life; Wavin pipes provide this vital fluid to your households in an easy and healthy way at a competitive price

## WAVIN POLYPROPYLENE PIPES

### • Wavin Pipes (PPR-Mono Layer)

- ▶ Superior physical characteristics at 90°C,
- ▶ High chemical resistance,
- ▶ Definite solutions to calcification and corrosion,
- ▶ No bacteria and moss reproduction within the pipes,
- ▶ Light, easy to install and low labor cost of installation,
- ▶ Safe to use various pressurized liquids and gas,
- ▶ No reduction in diameter at welding points,
- ▶ 60°C, 10 bars and 70°C, 8 bar pressure resistance for a service life of 50 years.
- ▶ Can be used in drinking water systems and has a quality certificate issued by the Ministry of Health and Hygiene-Institute

### • Wavin Pipes (PP-RCT Mono Layer)

- ▶ Wavin PP-RCT Pipes are made of the raw material PP-RCT which is new generation polypropylene designed for hot and cold water systems.
- ▶ It is the better pipe with higher flow rate, improved pressure resistance and easier to handle.
- ▶ It has improved pressure resistance at higher temperatures for long term period.
- ▶ It has 37 % larger inner flow area
- ▶ Larger inner bore and better flow rates
- ▶ Wavin PP-RCT can be used with all standard Wavin PP-R fittings
- ▶ Available in different color options

### • Glass Fiber Reinforced Composite Pipes (PPR-Multi Layer)

- ▶ GFR PPR pipe is multilayered and elongates less during the heat differences.
- ▶ Unlike aluminium foiled pipes; there is no need to shave the end of the pipe. This provides ease of install.
- ▶ The linear coefficient of thermal expansion is very low (0,035mm/mK); accordingly greater stability. In comparison to standard pipes total quantity of clamps used is less, therefore total expenses reduces.
- ▶ Due to the low thermal conductivity of glass fiber itself, thermal conductivity coefficient of multilayer pipe is lower than solid wall pipe. Less insulation is necessary.
- ▶ It does not cause a change in the color, smell or the taste of water. It has a hygienic structure. Can easily be used for hot and cold water systems

### • Basalt Fiber Composite Pipes (PP-RCT Multi Layer)

- ▶ Pipes are multilayer and made of the raw material PP-RCT which is new generation polypropylene designed for hot and cold water systems.
- ▶ Basalt fiber is made of pulping melted basalt stones of suitable composition.
- ▶ It is very durable and flexible and used in many different industries.
- ▶ Properties of basalt fiber significantly exceed glass fiber.
- ▶ Manufacturing of basalt fiber is very ecological and 100% recyclable
- ▶ 4-x lower linear thermal expansion than solid wall pipes,
- ▶ No need to shave before welding
- ▶ Higher pressure resistance at higher temperatures by up to 50%
- ▶ Temperature resistance up to 90°C
- ▶ Higher flow rate by up to 20%

**PHYSICAL AND MECHANICAL PROPERTIES OF RAW MATERIAL - PP-R**

Properties	Testing Conditions	Unit	Testing Method	Result
MRS Classification	20°C, extrapolation 50 years	MPa	ISO 9080	10
Density	23°C	g/cm <sup>3</sup>	ISO 1183	0,89 - 0,91
Melting Flow Index MFI	190°C, 5 kg	g/10dk g/10min	ISO 1133	0,4 - 0,6
	230°C, 2,16 kg			0,2 - 0,5
	230°C, 5 kg			0,8 - 1,3
Tensile Stress at Yield	23°C, 50 mm/dk 50 mm/min	MPa	ISO 527	23 - 28
Tensile Strain at Yield	23°C, 50 mm/dk 50 mm/min	%	ISO 527	min %10
Elasticity Modulus	23°C, 1 mm/dk 1 mm/min	MPa	ISO 527	800 - 1000
Charpy Notched Impact Strength	0°C	kJ/m <sup>2</sup>	ISO 179	>3,5
Thermal Conductivity	-	W/(m K)	DIN 52612	0,24
Coefficient of Thermal Expansion (0°C/90°C)	-	1/K	DIN 53752	1,5*10 <sup>-4</sup>

**ISOTHERMAL MECHANICAL STRENGTH GRAPHIC FOR PP-R**

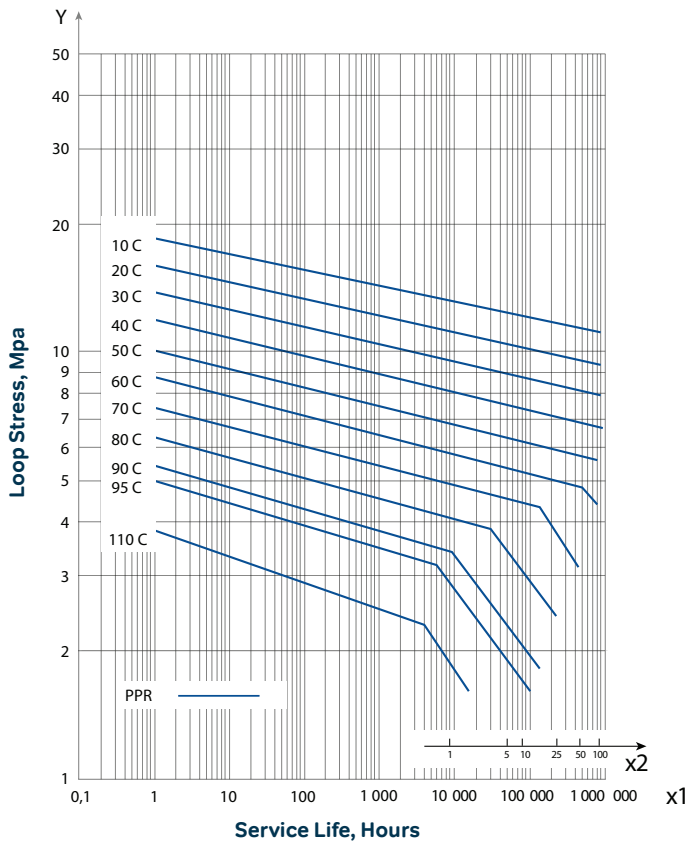



**PHYSICAL AND MECHANICAL PROPERTIES OF RAW MATERIAL - PP-RCT**

Properties	Testing Conditions	Unit	Testing Method	Result
MRS Classification	20°C, extrapolation 50 years	MPa	ISO 9080	11,2
CRS Classification	70°C, extrapolation 50 years	MPa	ISO 9080	5,3
Density	23°C	g/cm <sup>3</sup>	ISO 1183	0,89 - 0,91
Melting Flow Index MFI	190°C, 5 kg	g/10dk g/10min	ISO 1133	0,4 - 0,6
	230°C, 2,16 kg			0,2 - 0,5
	230°C, 5 kg			0,8 - 1,3
Tensile Stress at Yield	23°C, 50 mm/dk 50 mm/min	MPa	ISO 527	23 - 28
Tensile Strain at Yield	23°C, 50 mm/dk 50 mm/min	%	ISO 527	min %10
Elasticity Modulus	23°C, 1 mm/dk 1 mm/min	MPa	ISO 179	800 - 900
Charpy Notched Impact Strength	0°C	kJ/m <sup>2</sup>	ISO 179	9,5
Izod Notched Impact Strength	0°C	kJ/m <sup>2</sup>	DIN 52612	17
Thermal Conductivity	-	W/(m K)	DIN 52612	0,24
Coefficient of Thermal Expansion (0°C/90°C)	-	1/K	DIN 53752	1,5*10 <sup>-4</sup>

**ISOTHERMAL MECHANICAL STRENGTH GRAPHIC FOR PP-RCT**

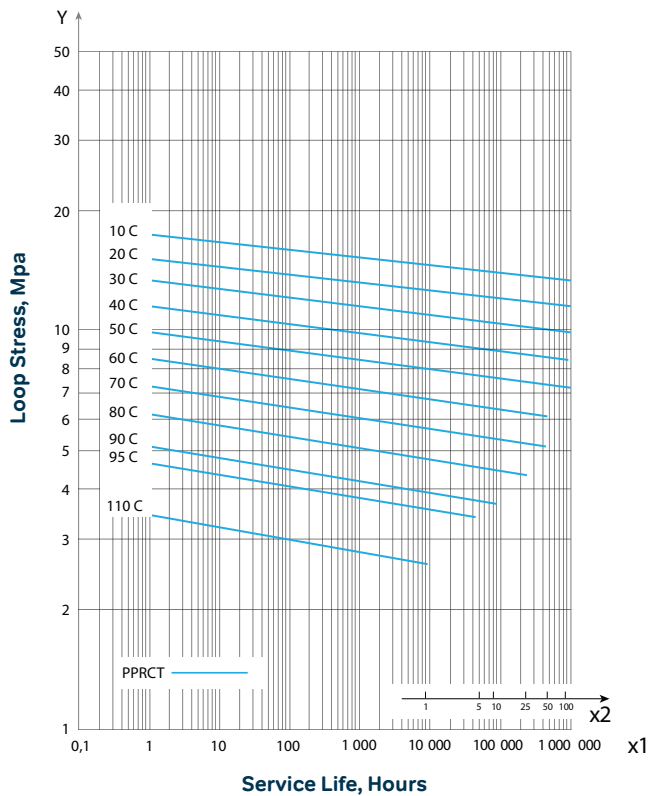

**OPERATING PARAMETERS FOR PP-R & PP-RCT PIPES**

		PP-R Pipe Glass Fiber Reinforced PP-R Pipe			PP-RCT Pipe / Basalt Reinforced PP-RCT Pipe		
		Operating Pressure			Operating Pressure		
Temp °C	Life (year)	S 2,5 SDR 6	S 3,2 SDR 7,4	S 5 SDR 11	S 3,2 SDR 7,4	S 4 SDR 9	S 5 SDR 11
10	1	35,1	27,8	17,5	30,2	24,0	19,0
	5	33,0	26,2	16,5	29,3	23,2	18,4
	10	32,2	25,6	16,1	28,9	22,9	18,2
	25	31,1	24,7	15,6	28,4	22,5	17,9
	50	30,3	24,1	15,2	28,0	22,2	17,7
	100	29,6	23,5	14,8	27,6	21,9	17,4
20	1	29,9	23,7	15,0	26,3	20,9	16,6
	5	28,1	22,3	14,1	25,4	20,2	16,0
	10	27,4	21,7	13,7	25,1	19,9	15,8
	25	26,4	21,0	13,2	24,6	19,6	15,5
	50	25,7	20,4	12,9	24,3	19,3	15,3
	100	25,0	19,9	12,5	24,0	19,0	15,1
30	1	25,4	20,2	12,7	22,7	18,1	14,3
	5	23,8	18,9	11,9	22,0	17,4	13,9
	10	23,2	18,4	11,6	21,7	17,2	13,6
	25	22,3	17,7	11,2	21,2	16,9	13,4
	50	21,7	17,2	10,9	20,9	16,6	13,2
	100	21,1	16,8	10,6	20,6	16,4	13,0
40	1	21,6	17,1	10,8	19,6	15,5	12,3
	5	20,2	16,0	10,1	18,9	15,0	11,9
	10	19,6	15,5	9,8	18,6	14,7	11,7
	25	18,8	15,0	9,4	18,2	14,4	11,5
	50	18,3	14,5	9,2	17,9	14,2	11,3
	100	17,8	14,1	8,9	17,6	14,0	11,1
50	1	18,2	14,5	9,1	16,7	13,3	10,5
	5	17,0	13,5	8,5	16,4	12,8	10,1
	10	16,5	13,1	8,2	15,8	12,6	10,0
	25	15,9	12,6	7,9	15,5	12,3	9,7
	50	15,4	12,2	7,7	15,2	12,1	9,6
	100	14,9	11,8	7,5	15,0	11,9	9,4
60	1	15,4	12,2	7,7	14,2	11,2	8,9
	5	14,3	11,3	7,1	13,6	10,8	8,6
	10	13,9	11,0	6,9	13,4	10,6	8,4
	25	13,3	10,5	6,6	13,1	10,4	8,2
	50	12,9	10,2	6,4	12,8	10,2	8,1
	100	12,9	10,3	6,5	11,9	9,4	7,5
70	1	12,9	10,3	6,5	11,9	9,4	7,5
	5	12,0	9,5	6,0	11,4	9,1	7,2
	10	11,6	9,2	5,8	11,2	8,9	7,0
	25	10,0	8,0	5,0	10,9	8,7	6,9
	50	8,5	6,7	4,2	10,7	8,5	6,8
	100	10,8	8,6	5,4	9,9	7,9	6,2
80	1	10,8	8,6	5,4	9,9	7,9	6,2
	5	9,6	7,6	4,8	9,5	7,5	6,0
	10	8,1	6,4	4,0	9,3	7,4	5,9
	25	6,5	5,1	3,2	9,1	7,2	5,7
95	7,6	1	6,1	3,8	7,4	5,9	4,7
	5,2	5	4,1	2,6	7,1	5,6	4,4
	4,3	10	(3,4)	(2,2)	(6,9)	(5,5)	(4,3)

\*Safety Factor (C): 1,5



## Pipes and fittings

### Wavin PPR Pipe (PPR-4mt)

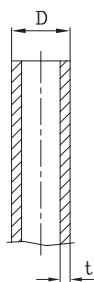

DN	t (mm) 10 Bar	t (mm) 16 Bar	t (mm) 20 Bar	s5 SDR 11 PN10	s3,2 SDR 7,4 PN16	s2,5 SDR 6 PN20	Bundle
20	1,9	2,8	3,4	3050477	3050481	3050484	25
25	2,3	3,5	4,2	3050492	3050496	3050499	20
32	2,9	4,4	5,4	3050506	3050510	3050513	10
40	3,7	5,5	6,7	3050520	3050524	3050528	5
50	4,6	6,9	8,3	3050533	3050537	3050541	5
63	5,8	8,6	10,5	3050546	3050555	3050559	3
75	6,8	10,3	12,5	3050565	3050569	3050572	2
90	8,2	12,3	15,0	3050576	3050580	3050583	2
110	10,0	15,1	18,3	3050588	3050593	3050596	1
125	11,4	17,1	20,8	3050601	3050605	3050608	1

### Wavin GlassFiber Multilayer Pipe (PPR-4mt)

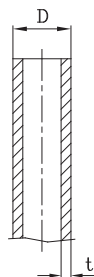

DN	t (mm) 20 Bar	t (mm) 25 Bar	s 3,2 SDR 7,4 PN20	s 2,5 SDR 6 PN 25	Bundle
20	3,4	2,8	3052080	3052081	25
25	4,2	3,5	3052082	3052083	20
32	5,4	4,4	3052084	3052085	10
40	6,7	5,5	3052086	3052087	5
50	8,3	6,9	3075178	3052088	5
63	10,5	8,6	3075449	3052089	3
75	12,5	10,3	3075887	3052090	2
90	15,0	12,3	3075888	3052091	2
110	18,3	15,1	3075939	3052092	1
125	20,8	17,1	3075940	3052093	1

### Wavin PP-RCT (4mt)

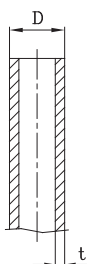

DN	t (mm)	s 4 SDR 9 PN 22	Bundle
20	2,3	3065530	25
25	2,8	3065531	20
32	3,6	3065532	10
40	4,5	3065533	5
50	5,6	3065534	5
63	7,1	3065535	3
75	8,4	3065536	2
90	10,1	3065537	2
110	12,3	3065538	1
125	14	3065539	1

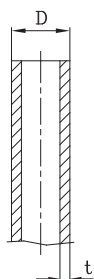

**Wavin BasaltFiber Multilayer Pipe (PP- RCT -4mt)**

DN	t (mm)	s 4 SDR 9 PN 22	s 3,2 SDR 7,4 PN 25	Bundle
20	2.8		3052146	25
25	3.5		3052147	20
32	4.4		3052148	10
40	5.5		3052149	5
50	6.9		3052150	5
63	8.6		3052151	3
75	8.4	3052152		2
90	10.1	3052153		2
110	12.3	3052154		1
125	14.0	3052155		1

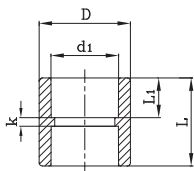

**Socket**

DN	Sap Code	Bag	Box	d (mm)	L1(min.) (mm)	D (mm)	L (mm)	k (mm)
20	3050911	50	600	19,50	14,50	28	33	4
25	3050912	40	400	24,50	16,00	34	37	4
32	3050913	20	240	31,50	18,00	42,5	41	4
40	3050914	15	120	39,40	20,50	53	46	4,5
50	3050915	10	100	49,40	23,50	66	52	4,5
63	3050916	6	48	62,50	27,50	83	60	4,5
75	3050917	6	30	74,70	30,00	100	65	5
90	3050918	1	24	89,20	33,00	120	71,5	6
110	3050919	1	10	109,00	37,00	146	80	6
125	3050920	1	10	124,60	40,00	167	86	6

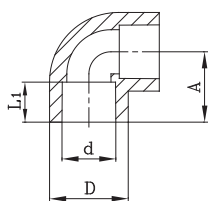

**Elbow (90°)**

DN	Sap Code	Bag	Box	d (mm)	L1(min.) (mm)	D (mm)	A (mm)
20	3050934	50	450	19,5	14,5	28	25,5
25	3050936	50	300	24,5	16	33	29,5
32	3050938	25	150	31,5	18	43,5	35
40	3050940	10	80	39,4	20,5	53	41,5
50	3050942	5	40	49,4	23,5	67	50
63	3050944	5	25	62,5	27,5	83,5	60
75	3050946	3	15	74,7	30	100	68
90	3050948	1	8	89,2	33	120	78,5
110	3050950	1	4	109	37	147	92,5
125	3050952	1	4	124,6	40	168	102





**Elbow (45°)**

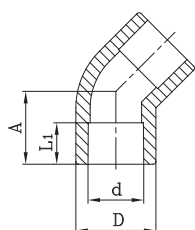

DN	Sap Code	Bag	Box	d (mm)	L1(min.) (mm)	D (mm)	A (mm)
20	3050933	50	400	19,5	14,5	26,5	20
25	3050935	50	250	24,5	16	33,5	22
32	3050937	20	120	31,5	18	43,5	32
40	3050939	10	100	39,4	20,5	52,5	31
50	3050941	8	48	49,4	23,5	68	35
63	3050943	4	24	62,5	27,5	84	42,5
75	3050945	3	18	74,7	30	100	47



**Elbow with Reducer**

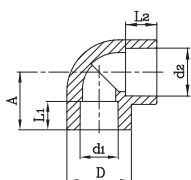

DN	Sap Code	Bag	Box	d1 (mm)	L1(min.) (mm)	d2 (mm)	L2(min.) (mm)	D	A
25-20	3051217	30	300	19,5	14,5	25	16	33	29,5



**Elbow (Female-Male) 90°**

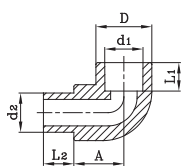

DN	Sap Code	Bag	Box	d1 (mm)	L1(min.) (mm)	d2 (mm)	L2(min.) (mm)	D (mm)	A (mm)
20	3050958	50	500	19,5	14,5	20	15	28,5	25
25	3050960	30	300	24,5	16	25	15,5	33,5	29,5
25/20	3050961	30	300	24,5	16	20	15,5	33	29,5

**Bend**

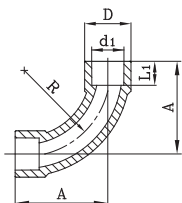

DN	Sap Code	Bag	Box	d1 (mm)	L1(min.) (mm)	D (mm)	L2(min.) (mm)	L (mm)
25	3079933	20	180	25,5	16	35	63,5	88

**Tee**

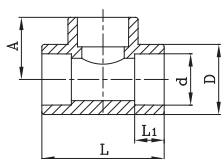

DN	Sap Code	Bag	Box	d (mm)	L1(min.) (mm)	D (mm)	L (mm)	A (mm)
20	3050996	30	240	19,5	14,5	27	51,5	26
25	3050997	25	150	24,5	16	33	63	30
32	3050998	15	90	31,5	18	43	72	36
40	3050999	5	50	39,4	20,5	53	85	43,5
50	3051000	4	32	49,4	23,5	66,5	100	50
63	3051001	3	18	62,5	27,5	84,5	119,5	60
75	3051002	2	12	74,7	30	100	130	73
90	3051003	1	6	89,2	33	120	158	79
110	3051004	1	4	109	37	146	186	93
125	3051005	1	3	124,6	40	167	208	103,5

**Cross Tee**

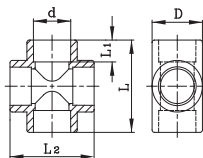

DN	Sap Code	Bag	Box	d (mm)	L1(min.) (mm)	D (mm)	L (mm)	L2 (mm)
20	3051046	25	200	19,5	14,5	26,5	51	51
25	3051047	15	150	24,5	16	33	60	60
32	3051048	10	90	31,5	18	42,5	70	70
40	3051049	5	50	39,4	20,5	53	84	84
50	3051050	3	24	49,4	23,5	66,5	103,5	103,5

**Manchon Union PN 10**

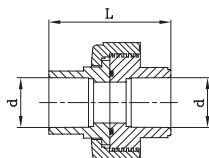

DN	Sap Code	Bag	Box	d (mm)	L (mm)
20	3051174	15	180	19,5	41
25	3051175	10	120	24,5	51
32	3051176	5	60	31,5	63
40	3051177	5	40	39,4	71
50	3051178	4	32	49,4	74



**Unequal Tee**

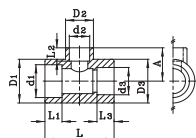

D1	D2	D3	Sap Code	Bag	Box	d1 (mm)	L1(min) (mm)	D1 (mm)	d2 (mm)	L2(min) (mm)	D2 (mm)	d3 (mm)	L3(min) (mm)	D3 (mm)	L (mm)	A (mm)
20x25x20			3051008	25	150	19,5	14,5	33	24,5	16	33,5	19,5	14,5	33	65	37,5
25x20x20			3051009	25	150	24,5	16	35	19,5	14,5	28	19,5	14,5	28	53	27,5
25x20x25			3051010	25	150	24,5	16	33	19,5	14,5	26,5	24,5	16	33	55	28,5
25x25x20			3051011	25	150	24,5	18	33,5	24,5	16	33,5	19,5	14,5	33,5	65	35,5
32x20x20			3051012	15	90	31,5	18	42,5	19,5	14,5	42,5	19,5	14,5	42,5	73,5	40,5
32x20x25			3051013	15	90	31,5	18	43	19,5	14,5	42,5	24,5	16	43	73,5	40,5
32x20x32			3051014	15	90	31,5	18	42,5	19,5	14,5	27	31,5	18	42,5	60	31,5
32x25x20			3051015	15	90	31,5	18	42,5	24,5	16	42,5	19,5	14,5	42,5	73,5	40
32x25x25			3051016	15	90	31,5	18	43	24,5	16	43	24,5	16	43	66	40
32x25x32			3051017	15	90	31,5	18	43	24,5	16	34	31,5	18	43	103	35
32x50x32			3051019	4	32	31,5	18	65	49,4	23,5	65	31,5	18	65	65,5	54,5
40x20x40			3051020	5	50	39,4	20,5	53	19,5	14,5	33	39,4	20,5	53	70	38,5
40x25x40			3051021	5	50	39,4	20,5	53	24,5	16	33	39,4	20,5	53	70	38,5
40x32x40			3051022	5	50	39,4	20,5	53	31,5	18	43	39,4	20,5	53	80	41
40x50x40			3051023	4	32	39,4	20,5	66	49,4	23,5	65,5	39,4	20,5	66	103	54,5
50x20x50			3051024	4	32	49,4	23,5	66,5	19,5	14,5	33	49,4	23,5	66,5	85	44
50x25x50			3051025	4	32	49,4	23,5	66,5	24,5	16	33	49,4	23,5	66,5	85	44
50x32x32			3051026	4	32	49,4	23,5	66,5	31,5	18	65,5	31,5	18	66,5	103	55,5
50x32x40			3051027	5	50	49,4	23,5	66	31,5	18	65,5	39,4	20,5	66	103	54,5
50x32x50			3051018	4	32	49,4	23,5	65	31,5	18	51	49,4	23,5	65	90	49,5
50x40x32			3051028	4	32	49,4	23,5	66,5	39,4	20,5	66	31,5	18	66,5	103	55,5
50x40x40			3051029	4	32	49,4	23,5	66	39,4	20,5	65,5	39,4	20,5	66	104	55,5
50x40x50			3051030	4	32	49,4	23,5	65	39,4	20,5	52	49,4	23,5	65	90	49,5
50x50x32			3051031	4	32	49,4	23,5	66	49,4	23,5	66	31,5	18	66	103,5	55
50x50x40			3051032	4	32	49,4	23,5	65,5	49,4	23,5	65	39,4	20,5	65,5	103,5	54,5
63x20x63			3051033	2	20	62,5	27,5	84	19,5	14,5	26,5	62,5	27,5	84	80	52
63x25x63			3051034	2	20	62,5	27,5	84	24,5	16	33	62,5	27,5	84	85	52
63x32x63			3051035	2	20	62,5	27,5	84	31,5	18	42,5	62,5	27,5	84	91	52
63x40x63			3051036	2	20	62,5	27,5	83,5	39,4	20,5	53	62,5	27,5	83,5	101	54
63x50x63			3051037	2	20	62,5	27,5	83,5	49,4	23,5	66	62,5	27,5	83,5	112	57
75x20x75			3051038	1	12	74,7	30	100	19,5	14,5	33	74,7	30	100	130	60
75x25x75			3051039	1	12	74,7	30	100	24,5	16	33	74,7	30	100	130	60
75x32x75			3051040	1	12	74,7	30	100	31,5	18	53	74,7	30	100	130	60
75x40x75			3051041	1	12	74,7	30	100	39,4	20,5	53	74,7	30	100	130	60
75x50x75			3051042	1	12	74,7	30	100	49,4	23,5	83,5	74,7	30	100	130	68
75x63x75			3051043	1	12	74,7	30	100	62,5	27,5	83,5	74,7	30	100	130	68
90x75x90			3051044	1	8	89,2	33	120	74,7	30	120	89,2	33	120	158	79
110x90x110			3051045	1	4	109	37	146	89,2	33	146	109	37	146	186	93



**Female-Female Reducer**

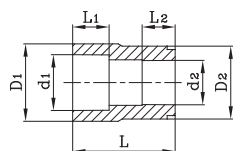

DN	Sap Code	Bag	Box	d1 (mm)	L1 (min) (mm)	d2 (mm)	L2 (min) (mm)	D1 (mm)	D2 (mm)	L (mm)
25/20	3051134	30	300	24,5	16	19,5	14,5	35	32,5	39
32/20	3051135	25	250	31,5	18	19,5	14,5	43	41	48,5
32/25	3051136	25	250	31,5	18	24,5	16	43	41	48,5



**Female-Male Reducer**

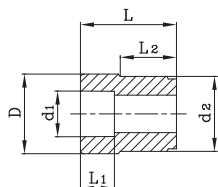

DN	Sap Code	Bag	Box	d1 (mm)	L1(min) (mm)	d2 (mm)	L2(min.) (mm)	D (mm)	L (mm)
25/20	3051112	40	560	19,5	14,5	25	18	29	39
32/20	3051113	30	300	19,5	14,5	32	13,5	35	39
32/25	3051114	30	300	24,5	16	32	15,5	35	39,5
40/20	3051115	30	240	19,5	14,5	29	25	40	47,5
40/25	3051116	30	240	24,5	16	34	24,5	40	48
40/32	3051117	20	200	31,5	18	40	27,5	42	47
50/20	3051118	20	200	19,5	14,5	29	23,5	50	48
50/25	3051119	25	200	24,5	16	34	23,5	50	49,5
50/32	3051120	15	150	31,5	18	42	23,5	50,5	47,5
50/40	3051121	10	120	39,4	20,5	50	24,5	53,5	48
63/25	3051122	10	120	24,5	16	34	28	63	56,5
63/32	3051123	10	120	31,5	18	43	28,5	63	57,5
63/40	3051124	5	80	39,4	20,5	53	28	63	53
63/50	3051125	5	60	49,4	23,5	63	28	67	53
75/50	3051126	5	50	49,4	23,5	67	31	75,5	61,5
75/63	3051127	5	40	62,5	27,5	75	26	84,5	67
90/63	3051128	4	36	62,5	27,5	84	28	90	76,5
90/75	3051129	2	24	74,7	30	90	33	97	81,5
110/63	3051130	1	18	62,5	27,5	84	32,5	110	88
110/75	3051131	1	18	74,7	30	100	32,5	110	91,5
110/90	3051132	1	18	89,2	33	110	32,5	119	93,5
125/110	3051133	1	13	109	37	125	37	148	102



**Flange Adaptor**

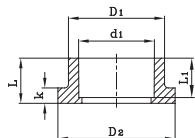

DN	Sap Code	Bag	Box	d (mm)	L1(min.) (mm)	D1 (mm)	D2 (mm)	L (mm)	k (mm)
40	3051165	25	250	39,4	20,5	50,5	62	24	8,5
50	3051166	15	150	49,4	23,5	61,5	73,5	27	8,5
63	3051167	10	80	62,5	27,5	77	90,5	31,5	8
75	3051168	4	36	74,7	30	90,5	106	38	16
90	3051169	4	36	89,2	33	109	124,5	42,5	18
110	3051170	2	20	109	37	132	150,5	50	21
125	3051171	1	12	124,6	40	164	185	62	20



**Saddle**

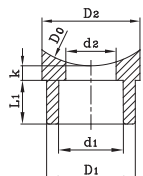

DN	Sap Code	Bag	Box	d0 (mm)	d1 (mm)	L1(min.) (mm)	d2 (mm)	D1 (mm)	D2 (mm)	k (mm)
63/20	3051137	50	600	63	19,5	14,5	17	28,5	37	6
63/25	3051139	50	600	75	19,5	14,5	17	28,5	37	6
75/20	3051141	50	600	90	19,5	14,5	17	28,5	37	6
75/25	3051143	50	600	110	19,5	14,5	17	28,5	37	6
90/20	3051138	50	600	63	24,5	16	19	33,5	37,5	6
90/25	3051140	50	600	75	24,5	16	19	33,5	37,5	6
110/20	3051142	50	600	90	24,5	16	19	33,5	37,5	6
110/25	3051144	50	600	110	24,5	16	19	33,5	37,5	6



**Crossover Bridge**

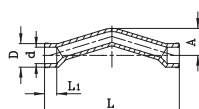

DN	Sap Code	Bag	Box	d1 (mm)	L1(min.) (mm)	D (mm)	L (mm)	A (mm)
20	3051106	15	150	19,5	14,5	28,5	160	33
25	3051107	10	100	24,5	16	33	194	40
32	4056716	4	56	31,5	18	46	216	49



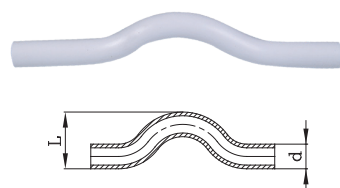

**Bridge**

DN	Sap Code	Bag	Box	d (mm)	L (mm)
20	3051102	15	135	20	45
25	3051103	10	90	25	55
32	3051104	5	45	32	69
40	3051105	3	27	40	85

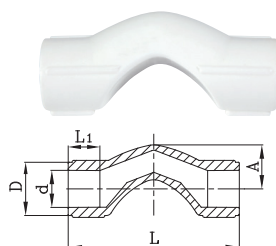

**Short Bridge**

DN	Sap Code	Bag	Box	d (mm)	L1(min.) (mm)	D (mm)	A (mm)	L (mm)
20	4047830	30	240	19,5	14,5	28	23	90
25	4047831	25	150	24,5	16	33,5	31	96

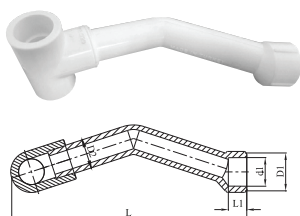

**Tee w/ V Type Bridge**

DN	Sap Code	Bag	Box	d1 (mm)	L1(min.) (mm)	D1 (mm)	D2 (mm)	L (mm)
20/20/20	3074991	10	100	19,5	14,5	28	20	160
25/25/25	3074992	10	100	24,5	16	32,5	25	203
25/20/25	3074993	5	50	19,5	14,5	28	20	165
32/25/32	3074994	5	50	24,5	16	32,5	25	212

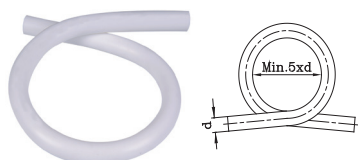

**Omega**

DN	Sap Code	Bag	Box	d (mm)
20	3051108	5	25	20
25	3051109	3	15	25
32	3051110	1	8	32
40	3051111	1	4	40

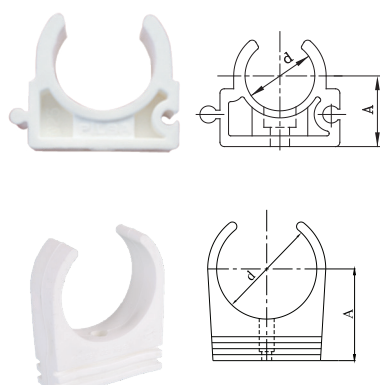

**Clips**

DN	Sap Code	Bag	Box	d (mm)	A (mm)
20	3050985	100	1200	20,5	19
25	3050986	80	960	25,5	22
32	3050987	50	500	32,5	25
40	3050988	40	320	40,5	29
50	3050989	25	200	48,5	44

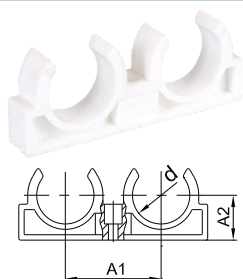

**Double Clips**

DN	Sap Code	Bag	Box	d (mm)	A1 (mm)	A2 (mm)
20	3050990	50	500	20	38	17,5
25	3050991	40	320	25	44,5	19,5
32	3050992	25	200	32	53,5	25

**Manifold**

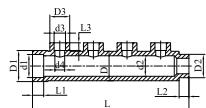

DN	Sap Code	d1 (mm)	L1 (mm)	D1 (mm)	D2 (mm)	L2 (mm)	d2 (mm)	d3 (mm)	D3 (mm)	L3 (mm)	d4 (mm)	D (mm)	L (mm)
50x25	3081245	49,4	23,5	66,5	50	21	44	24,5	42,5	16,0	21	63	335
50x32	3081549	49,4	23,5	66,5	50	21	44	24,5	42,5	16,0	28	63	335

**End Cap**

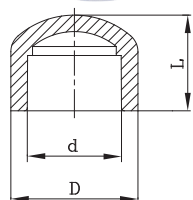

DN	Sap Code	Bag	Box	d (mm)	D (mm)	L (mm)
20	3050921	100	800	19,5	28,5	25,5
25	3050922	80	640	24,5	34,5	29
32	3050923	50	400	31,5	43	32
40	3050924	25	200	39,4	53,5	37,5
50	3050925	10	100	49,4	67	43,5
63	3050926	10	80	62,5	85	52
75	3050927	6	48	74,7	100,5	58
90	3050928	4	32	89,2	121	64
110	3050929	2	16	109	146,5	71,5

**Male Threaded End Cap**

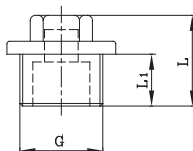

DN	Sap Code	Bag	Box	L1 (mm)	L (mm)	G (mm)
20x1/2	3050930	100	1000	11	34	1/2"
25x3/4	3050931	80	640	11	31	3/4"
32x1	3050932	50	400	20	40	1"

**Female Threaded Adaptor**

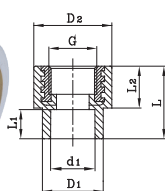

DN	Sap Code	Bag	Box	d1 (mm)	L1 (min) (mm)	D1 (mm)	D2 (mm)	L2 (mm)	L (mm)	G (mm)
20x1/2	3087071	20	320	19,5	14,5	28,5	38,5	24	40,5	1/2"
20x3/4	3087072	20	240	19,5	14,5	29	42,5	24	40	3/4"
25x1/2	3087073	25	250	24,5	16	33,5	38	24	40,5	1/2"
25x3/4	3087075	20	280	24,5	16	33	42,5	24	40,5	3/4"
32x3/4	3087076	10	120	31,5	18	43	45,5	24,5	44	3/4"
32x1	3051073	10	120	31,5	18	43	53	28	47,5	1"

**Female Threaded Adaptor (Hexagonal Shaped)**

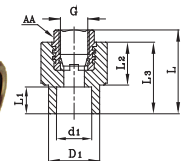

DN	Sap Code	Bag	Box	d1 (mm)	L1 (min) (mm)	D1 (mm)	L2 (mm)	L3 (mm)	L (mm)	G (mm)
40x1 1/4"	3051074	10	40	39,4	20,5	54	25,5	47	61	1-1/4"
50x1 1/2"	3051075	4	24	49,4	23,5	68	29	53,5	67,5	1-1/2"
63x2"	3051076	2	14	62,5	27,5	84	28,5	55	73	2"
75x2 1/2"	3051077	2	12	74,7	30	100	30	59,5	78	2-1/2"
90x3"	3051078	1	5	89,2	33	120,5	44	75,5	92	3"
110x4"	3051079	1	4	109	37	147	48	84	102	4"



**Male Threaded Adaptor**

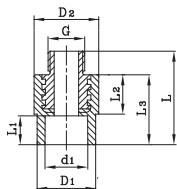

DN	Sap Code	Bag	Box	d1 (mm)	L1(min) (mm)	D1 (mm)	D2 (mm)	L (mm)	L2 (mm)	L3 (mm)	G (mm)
20x1/2	3087077	25	250	19,5	14,5	28,5	35	53	24	40	1/2"
20x3/4	3087078	20	200	19,5	14,5	29	42,5	53	23,5	40	3/4"
25x1/2	3087079	15	240	24,5	16	34	39	53	23,5	40	1/2"
25x3/4	3087080	15	150	24,5	16	33	42	53	24	40	3/4"
32x3/4	3087081	10	100	31,5	18	43	45	57	24,5	44	3/4"
32x1	3051085	10	100	31,5	18	43	52,5	62,5	28	47	1"



**Male Threaded Adaptor (Hexagonal Shaped)**

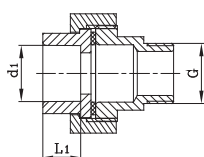

DN	Sap Code	Bag	Box	d1 (mm)	L1(min) (mm)	D1 (mm)	L2 (mm)	L3 (mm)	L (mm)	G (mm)
40x1 1/4"	3051086	5	25	39,4	20,5	54	25	47	81	1-1/4"
50x1 1/2"	3051087	2	16	49,4	23,5	68	29	53,5	87,5	1-1/2"
63x2"	3051088	1	10	62,5	27,5	84	28,5	55	98	2"
75x2 1/2"	3051089	1	6	74,7	30	100	30	59,5	105	2-1/2"
90x3"	3051090	1	5	89,2	33	120,5	43,5	76	118	3"
110x4"	3051091	1	3	109	37	147	48	84,5	129,5	4"



**Female Threaded Tee**

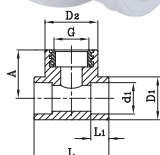

DN	Sap Code	Bag	Box	d1 (mm)	L1(min) (mm)	D1 (mm)	D2 (mm)	A (mm)	L (mm)	G (mm)
20x1/2	3087065	25	200	19,5	14,5	27	38,5	35	51,5	1/2"
20x3/4	3087066	20	140	19,5	14,5	28,5	43	36	60,5	3/4"
25x1/2	3087067	20	120	24,5	16	33	38	37	60	1/2"
25x3/4	3051055	15	120	24,5	16	35	43,5	37	59,5	3/4"
32x1	3051056	10	70	31,5	18	43,5	53,5	43	70	1"



**Male Threaded Tee**

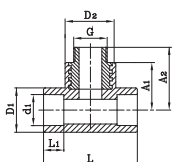

DN	Sap Code	Bag	Box	d1 (mm)	L1(min) (mm)	D1 (mm)	D2 (mm)	A1 (mm)	A2 (mm)	L (mm)	G (mm)
20x1/2	3087068	15	150	19,5	14,5	27	38,5	35	47,5	51,5	1/2"
20x3/4	3087069	10	130	19,5	14,5	28,5	43	36,5	49,5	60,5	3/4"
25x1/2	3087070	10	100	24,5	16	33	38	37	50,5	60,5	1/2"
25x3/4	3051060	10	100	24,5	16	35	43	36,5	49,5	59,5	3/4"
32x1	3051061	10	60	31,5	18	43	53,5	48	63,0	73,5	1"



**Female Threaded Elbow**

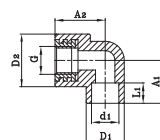

DN	Sap Code	Bag	Box	d1 (mm)	L1(min) (mm)	D1 (mm)	D2 (mm)	A1 (mm)	A2 (mm)	G (mm)
20x1/2	3087063	25	250	19,5	14,5	28,5	38,5	31,5	36	1/2"
20x3/4	3087074	20	280	19,5	14,5	29	40	31	35,5	3/4"
25x1/2	3087085	20	160	24,5	16	33,5	38,5	32	38	1/2"
25x3/4	3087087	15	180	24,5	16	33,5	43	32	40	3/4"
32x3/4	3087088	10	100	31,5	18	44	57,5	34	45	3/4"
32x1	3050968	10	100	31,5	18	43,5	54,0	34	45	1"



**Male Threaded Elbow**

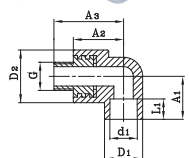

DN	Sap Code	Bag	Box	d1 (mm)	L1(min) (mm)	D1 (mm)	D2 (mm)	A1 (mm)	A2 (mm)	A3 (mm)	G (mm)
20x1/2	3087089	25	200	19,5	14,5	28,5	38,5	31,5	36	49	1/2"
20x3/4	3087090	10	180	19,5	14,5	29	40	31	36	48	3/4"
25x1/2	3087091	10	140	24,5	16	33,5	38,5	32	38	51	1/2"
25x3/4	3087092	20	160	24,5	16	33,5	43	32	40	53	3/4"
32x3/4	3087064	10	80	31,5	18	43,5	57,5	34,5	45	58	3/4"
32x1	3050974	10	80	31,5	18	43,5	54	34,5	45	60	1"



**Underplaster Female Elbow**

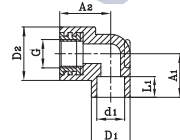

DN	Sap Code	Bag	Box	d1 (mm)	L1(min) (mm)	D1 (mm)	D2 (mm)	A1 (mm)	A2 (mm)	A3 (mm)	G (mm)
20	3087082	20	200	19,5	14,5	28	38,5	31	35	48	1/2"
25	3087083	15	180	24,5	16	33	38,5	31,5	36	49	1/2"



**Underplaster Male Elbow**

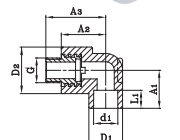

DN	Sap Code	Bag	Box	d1 (mm)	L1(min) (mm)	D1 (mm)	D2 (mm)	A1 (mm)	A2 (mm)	A3 (mm)	G (mm)
20	3087084	15	180	19,5	14,5	28	38,5	31	35	48	1/2"
25	3087086	10	180	24,5	16	33	38,5	31	36	49	1/2"



**Adjustable Underplaster Female Elbow**

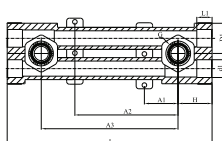

DN	Sap Code	Bag	Box	d1 (mm)	L1(min) (mm)	D1 (mm)	A1 (mm)	A2 (mm)	A3 (mm)	L (mm)	H (mm)	G (mm)
20x1/2	3051149	3	36	19,5	14,5	33	37	113	150	224	38	1/2"
25x1/2	4064554	3	36	24,5	16,5	33	37	113	150	224	38	1/2"



**Double Stable Underplaster Female Elbow**

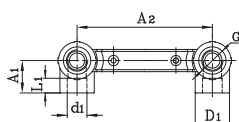

DN	Sap Code	Bag	Box	d1 (mm)	L1(min) (mm)	D1 (mm)	A1 (mm)	A2 (mm)	G (mm)
20x1/2	4047836	5	60	19,5	14,5	34	32	150	1/2"
25x1/2	4047837	5	60	24,5	16	34	32	150	1/2"



**Bide Nozzle Part Female**

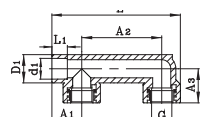

DN	Sap Code	Bag	Box	d1 (mm)	L1(min) (mm)	D1 (mm)	A1 (mm)	A2 (mm)	A3 (mm)	L (mm)	G (mm)
20x1/2	3051215	10	60	19,5	14,5	27	28,5	90	32	136	1/2"



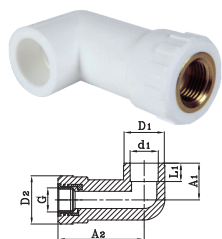

**Elbow Long**

DN	Sap Code	Bag	Box	d1	L1(min.) (mm)	D1 (mm)	D2 (mm)	A1 (mm)	A2 (mm)	G (mm)
25x1/2	4049356	25	150	24,5	16	35	42	32	75	1/2"

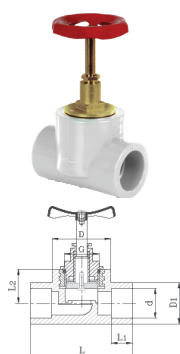

**Valve**

DN	Sap Code	Bag	Box	d1 (mm)	L1(min.) (mm)	D1 (mm)	D (mm)	A (mm)	L (mm)	G (mm)
20	3078893	5	70	19,5	14,5	28	38	26	72	1/2"
25	3078896	5	70	24,5	16	33	42	30	77	3/4"
32	3078919	3	42	31,5	18	42,5	53	39	80	1"
40	3051183	3	30	39,4	20,5	54	64	43	111	1-1/4"

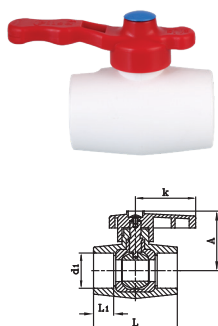

**Ball Valve**

DN	Sap Code	Bag	Box	d (mm)	L1(min.) (mm)	A (mm)	k (mm)	L (mm)
20	3079030	5	120	19,5	14,5	50	56	68
25	3079031	5	120	24,5	16	50	56	68
32	3079032	5	80	31,5	18	54	56	75
		4						

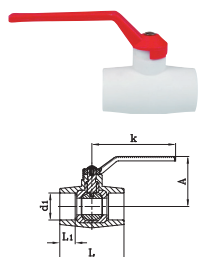

40	3069807	4	48	39,4	20,5	71	119	89
50	3069808	2	28	49,4	23,5	78	119	12
63	3070079	1	15	62,5	27,5	90	157	128
75	3070080	1	12	74,7	30	100	157	148

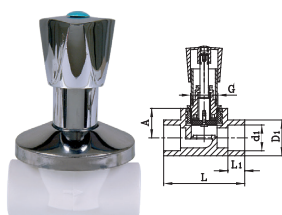

**Chrome Valve**

DN	Sap Code	Bag	Box	d1 (mm)	L1(min.) (mm)	D1 (mm)	A (mm)	L (mm)	G (mm)
20	3072118	1	60	19,5	14,5	28,5	26,5	72	3/4"
25	3051185	1	60	24,5	16	33,5	30	77	3/4"
32	3051186	1	50	31,5	18	42,5	39	80	1"

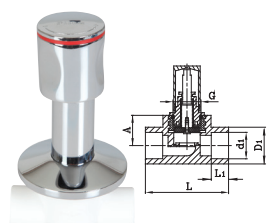

**Valve Round Cap**

DN	Sap Code	Bag	Box	d1 (mm)	L1(min.) (mm)	D1 (mm)	A (mm)	L (mm)	G (mm)
20	3072164	1	60	19,5	14,5	28,5	26,5	72	3/4"
25	3052745	1	60	24,5	16	33,5	30	77	3/4"
32	3052746	1	50	31,5	18	43	38,5	80,5	1"

**Decorative Valve**

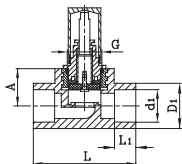

DN	Sap Code	Bag	Box	d1 (mm)	L1(min) (mm)	D1 (mm)	A (mm)	L (mm)	G (mm)
20	3072161	1	60	19,5	14,5	28,5	26,5	72	3/4"
25	3051190	1	60	24,5	16	33,5	30	77	3/4"
32	3051191	1	50	31,5	18	42,5	39	80	1"

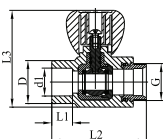

**Radiator Valve Straight**

DN	Sap Code	Bag	Box	d1 (mm)	L1(min) (mm)	D (mm)	L2 (mm)	L3 (mm)	G (mm)
20	4047845	5	80	19,5	14,5	30	66	68	3/4"
25x3/4	4081144	5	80	24,30	18	35,50	66	68	3/4"

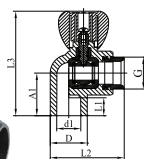

**Radiator Valve Elbow**

DN	Sap Code	Bag	Box	d1 (mm)	L1(min) (mm)	D (mm)	A1 (mm)	L2 (mm)	L3 (mm)	G (mm)
20	4047844	5	80	19,5	14,5	30	34,5	60	85	3/4"
25x3/4	4081145	5	80	24,30	16,50	30	35,50	68,50	71	3/4"

**Metal Female Threaded Union (Hexagonal Shaped)**

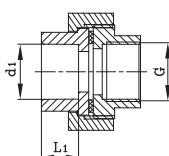

DN	Sap Code	Bag	Box	d (mm)	L1(min.) (mm)	G (mm)
20x1/2"	3051151	10	120	19,5	14,5	1/2"
25x3/4"	3051152	10	80	24,5	16	3/4"
32x3/4"	3051153	5	60	31,5	18	3/4"
32x1"	3051154	5	60	31,5	18	3/4"
40x1 1/4"	3051155	2	24	39,4	20,5	1-1/4"
50x1 1/2"	3051156	2	24	49,4	23,5	1-1/2"
63x2"	3051157	2	18	62,5	27,5	2"

**Metal Male Threaded Union (Hexagonal Shaped)**

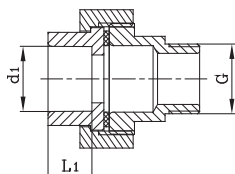
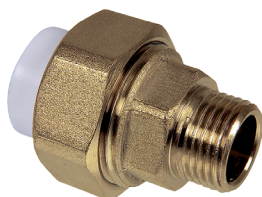

DN	Sap Code	Bag	Box	d (mm)	L1(min.) (mm)	G (mm)
20x1/2"	3051158	10	120	19,5	14,5	1/2"
25x3/4"	3051159	10	80	24,5	16	3/4"
32x3/4"	3051160	5	50	31,5	18	3/4"
32x1"	3051161	5	50	31,5	18	1"
40x1 1/4"	3051162	2	24	39,4	20,5	1-1/4"
50x1 1/2"	3051163	2	20	49,4	23,5	1-1/2"
63x2"	3051164	2	16	62,5	27,5	2"

**Shifting Elbow with Metal Transition**

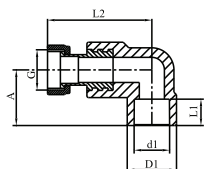

DN	Sap Code	Bag	Box	d1 (mm)	L1(min) (mm)	D1 (mm)	A1 (mm)	L2 (mm)	G (mm)
20x1/2	3051201	30	300	28	14,6	19,3	30	44	1/2"
25x3/4	3051202	25	250	33,50	17,15	24,30	33	44	3/4"

**Shifting Union With Metal Transition**

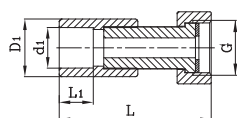

DN	Sap Code	Bag	Box	d1 (mm)	L1 (min) (mm)	D1 (mm)	L (mm)	G (mm)
20x1/2	4047817	30	300	19,5	14,5	28,5	57	1/2"
20x3/4	4047818	25	250	19,5	14,5	29	59	3/4"
25x1/2	4047819	25	250	24,5	16	33,5	59	1/2"
25x3/4	4047820	25	250	24,5	16	33	59	3/4"
25x1	4065368	20	200	24,5	16	42,5	72	1"

**Shifting Union With Plastic Transition**

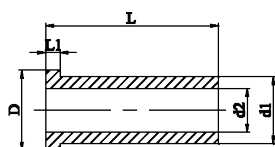
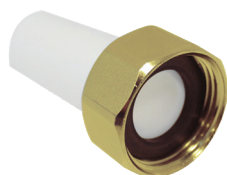

DN	Sap Code	d1 (mm)	D2 (mm)	D (mm)	L (mm)	L1 (mm)
25x1	3081757	25,0	16,2	29,8	64,5	5,4

**Strainer Y with Filter**

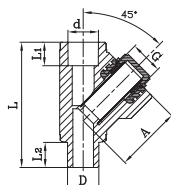

DN	Sap Codes	Bag	Box	d1 (mm)	L1 (min) (mm)	D (mm)	D2 (mm)	L (mm)	G (mm)
20x1/2	3051203	20	200	19,5	14,5	30	41	80	1/2"
25x3/4	3051204	10	120	24,5	16	35	46	101,5	3/4"



**Welding Head**

DN	Sap Code	Box
20	3033427	50
25	3033428	50
32	3033429	50
40	3033430	50
50	3033431	50
63	3033432	30
75	3033433	30
90	3033434	30
110	3033435	20
125	3033436	10



**Cutter**

DN	Sap Code	Box
20-25-32	3033042	30
40-63	4047816	20



**Welding Machine Set**

DN	Sap Code	Box
16-40	3033236	5
50-110	3040363	1







# Discover our broad portfolio at [www.wavin.com.tr](http://www.wavin.com.tr)

- Hot&Cold Water
- Indoor Climate Solutions
- Urban Climate Resillience
- Waste Water Drainage
- Water and Gas Distribution
- Foul Water

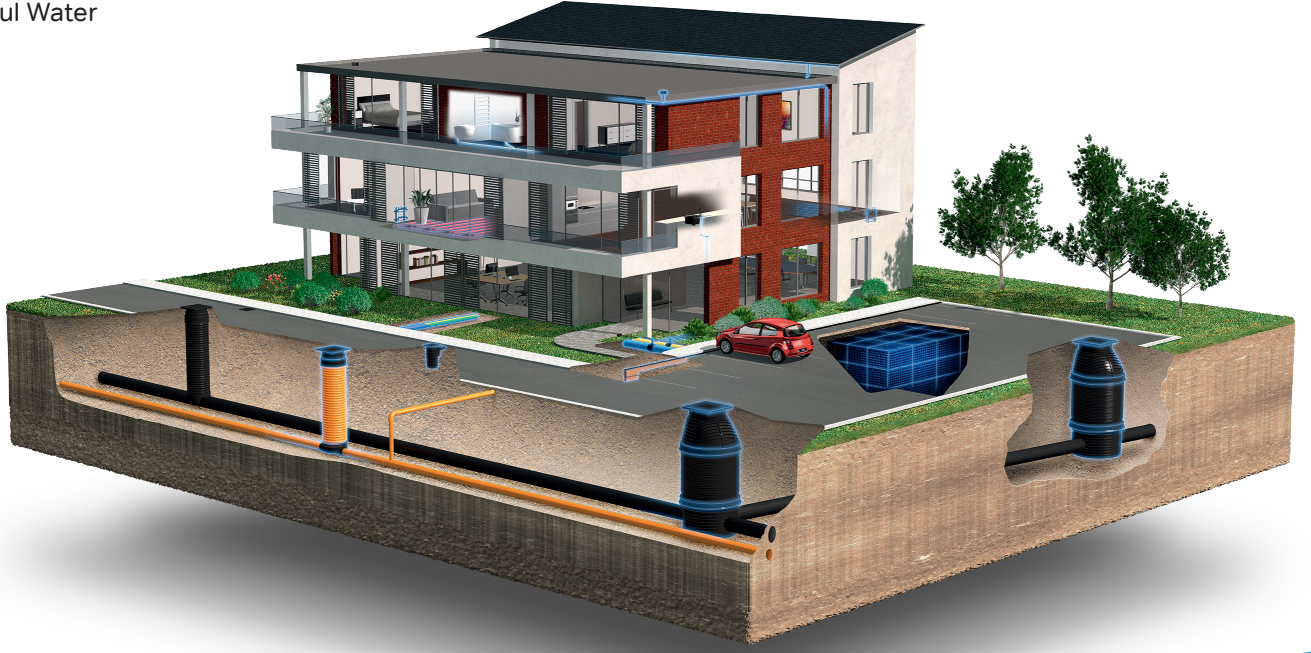

**wavin**

**orbia** 

Wavin is part of Orbia, a community of companies working together to tackle some of the world's most complex challenges.

We are bound by a common purpose:  
To Advance Life Around the World.

Wavin TR Plastik Sanayi A.Ş. | Güzelevler Mah.Girne Bulvarı No: 294/A Yüreğir / Adana  
Web [www.wavin.com.tr](http://www.wavin.com.tr) | E-mail [wavin.tr.info@wavin.com](mailto:wavin.tr.info@wavin.com)

Wavin operates a programme of continuous product development, and therefore reserves the right to modify or amend the specification of their products without notice. All information in this publication is given in good faith, and believed to be correct at the time of going to press. However, no responsibility can be accepted for any errors, omissions or incorrect assumptions.

© 2022 Wavin | Wavin reserves the right to make alterations without prior notice. Due to continuous product development, changes in technical specifications may change. Installation must comply with the installation instructions.