

Water distribution  
Heating and cooling  
**CATALOGUE OF PRODUCTS**



**EKOPLASTIK®**

CONNECT TO BETTER

# Ekoplastik System

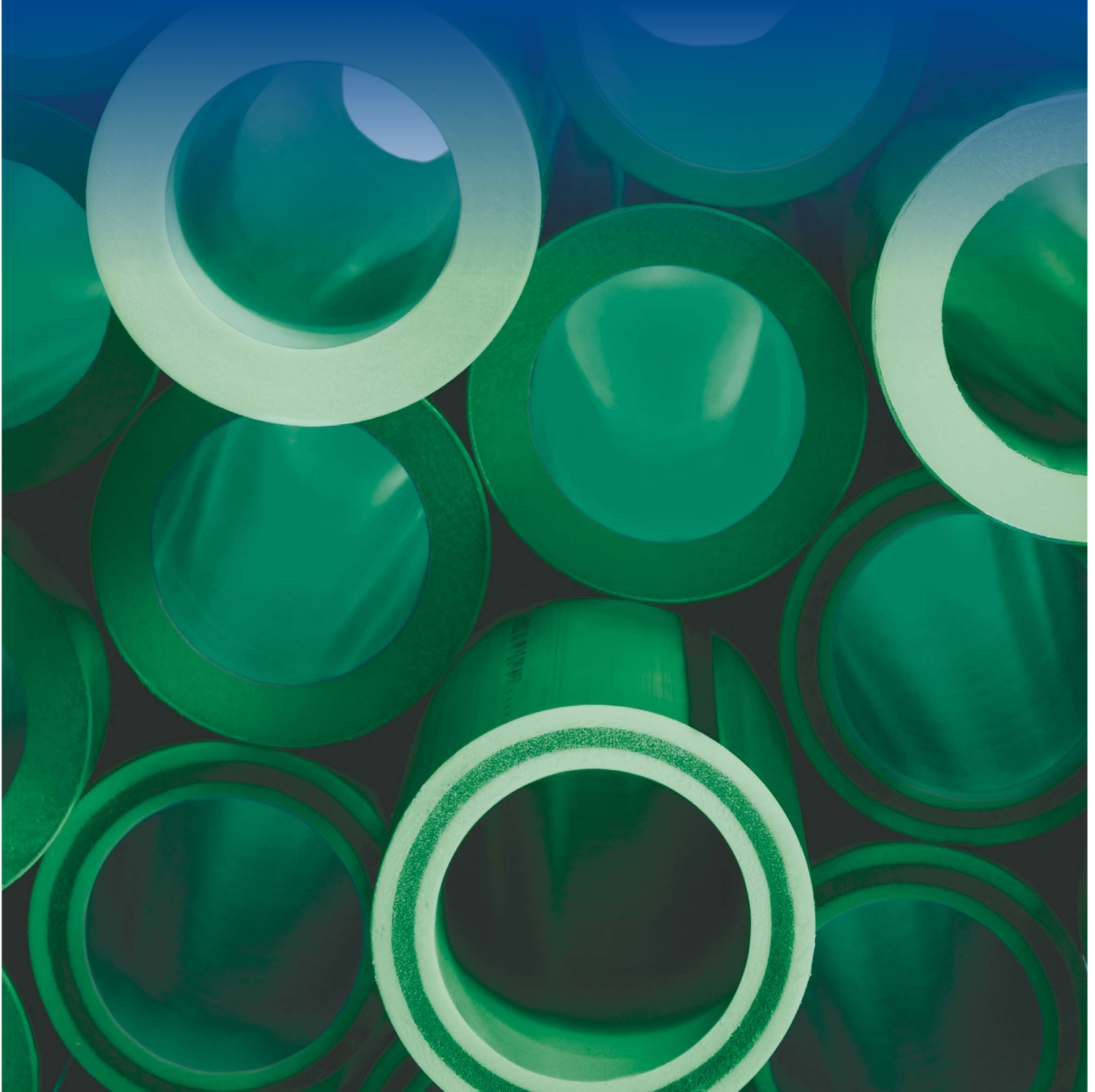

# Contents

Standard Products for Potable (Cold) and Hot Water and for Heating (I.).....	4-22
Standard Products only for Potable (Cold) Water (II.) .....	23
Product for Temporary Use (non Standard) (III.) .....	23
Accessories (IV.) .....	24-30

# System Ekoplastik

System Ekoplastik is plastic piping system used for hot and cold water distribution in buildings, floor and central heating and airconditioning. Extended warranty period 10 years for standard products (I., II.), 2 years for nonstandard products (III.)

## Benefits

- ⦿ high quality PP piping systems from Wavin
- ⦿ includes new 4th generation material PP-RCT
- ⦿ includes unique 3 layer pipes with basalt fiber re-inforcement
- ⦿ high pressure and temperature resistance



# Standard Products for Potable (Cold) and Hot Water and for Heating (I.)

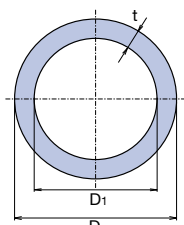

## PIPE S 5 / PN 10 / SDR 11

D	D <sub>1</sub>	t	l			KOD
mm	mm	mm	mm	m	kg/m	
20	15,6	2,2	4000	100	0,121	TTR020P10X
25	20,4	2,3	4000	60	0,164	TTR025P10X
32	26,2	2,9	4000	40	0,258	TTR032P10X
40	32,6	3,7	4000	24	0,413	TTR040P10X
50	40,8	4,6	4000	16	0,636	TTR050P10X
63	51,4	5,8	4000	12	1,004	TTR063P10X
75	61,4	6,8	4000	8	1,401	TTR075P10X
90	73,6	8,2	4000	4	2,014	TTR090P10X
110	90,0	10,0	4000	4	3,009	TTR110P10X
125	102,2	11,4	4000	4	3,910	TTR125P10X

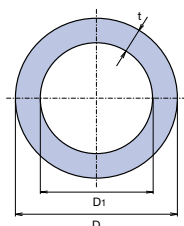

## PIPE S 3,2 / PN 16 / SDR 7,4

D	D <sub>1</sub>	t	l			KOD
mm	mm	mm	mm	m	kg/m	
16	11,6	2,2	4000	160	0,094	TTR016P16X
20	14,4	2,8	4000	100	0,145	TTR020P16X
25	18,0	3,5	4000	60	0,227	TTR025P16X
32	23,2	4,4	4000	40	0,367	TTR032P16X
40	29,0	5,5	4000	24	0,566	TTR040P16X
50	36,2	6,9	4000	16	0,886	TTR050P16X
63	45,8	8,6	4000	12	1,387	TTR063P16X
75	54,4	10,3	4000	8	1,990	TTR075P16X
90	65,4	12,3	4000	4	2,839	TTR090P16X
110	79,8	15,1	4000	4	4,274	TTR110P16X
125	90,8	17,1	4000	4	5,530	TTR125P16X

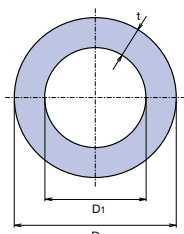

## PIPE S 2,5 / PN 20 / SDR 6

D	D <sub>1</sub>	t	l			KOD
mm	mm	mm	mm	m	kg/m	
16	10,6	2,7	4000	160	0,107	TTR016P20X
20	13,2	3,4	4000	100	0,169	TTR020P20X
25	16,6	4,2	4000	60	0,259	TTR025P20X
32	21,2	5,4	4000	40	0,423	TTR032P20X
40	26,6	6,7	4000	24	0,657	TTR040P20X
50	33,4	8,3	4000	16	1,013	TTR050P20X
63	42,0	10,5	4000	12	1,611	TTR063P20X
75	50,0	12,5	4000	8	2,288	TTR075P20X
90	60,0	15,0	4000	4	3,332	TTR090P20X
110	73,4	18,3	4000	4	4,977	TTR110P20X
125	83,4	20,8	4000	4	6,470	TTR125P20X

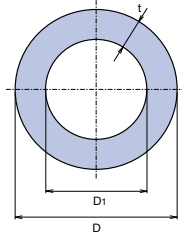

**PIPE S 2,5 / PN 20 / SDR 6 – 3 m**

D	D <sub>1</sub>	t	l	☰	⚖️	KOD
mm	mm	mm	mm	m	kg/m	
20	13,2	3,4	3000	75	0,169	TTR020P203
25	16,6	4,2	3000	45	0,259	TTR025P203
32	21,2	5,4	3000	30	0,423	TTR032P203

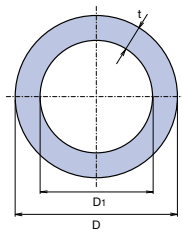
All pipes listed above could be manufactured in alternative lengths to special order by prior agreement.

**NEW**

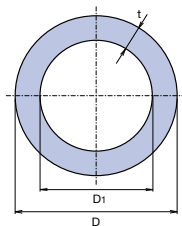
**PIPE EVO 16 mm S 3,2 / SDR 7,4 / PN 28 (calculation)**
**PIPE EVO 20-125 mm S 4 / SDR 9 / PN 22 (calculation)**

D	D <sub>1</sub>	t	l	☰	⚖️	KOD
mm	mm	mm	mm	m	kg/m	
16	11,6	2,2	4000	160	0,095	TTRE016S32
20	15,4	2,3	4000	100	0,127	TTRE020S4
25	19,4	2,8	4000	60	0,191	TTRE025S4
32	24,8	3,6	4000	40	0,313	TTRE032S4
40	31,0	4,5	4000	24	0,487	TTRE040S4
50	38,8	5,6	4000	16	0,755	TTRE050S4
63	48,8	7,1	4000	12	1,200	TTRE063S4
75	58,2	8,4	4000	8	1,690	TTRE075S4
90	69,8	10,1	4000	4	2,440	TTRE090S4
110	85,4	12,3	4000	4	3,620	TTRE110S4
125	97,0	14,0	4000	4	4,660	TTRE125S4

**PIPE - STABI PLUS 16-63 mm**
**S 3,2 / SDR 7,4 / PN 28 (calculation)**
**PIPE - STABI PLUS 75-110 mm**
**S 4 / SDR 9 / PN 22 (calculation)**

D	De	D <sub>1</sub>	t	l	☰	⚖️	KOD
mm	mm	mm	mm	mm	m	kg/m	
16	17,9	11,4	2,2	4000	120	0,137	TTRS016RCT
20	21,9	14,4	2,8	4000	80	0,207	TTRS020RCT
25	26,9	18,0	3,5	4000	60	0,298	TTRS025RCT
32	33,9	23,2	4,4	4000	40	0,465	TTRS032RCT
40	41,9	29,0	5,5	4000	20	0,692	TTRS040RCT
50	52,0	36,2	6,9	4000	16	1,046	TTRS050RCT
63	65,0	45,8	8,6	4000	8	1,587	TTRS063RCT
75	77,0	58,2	8,4	4000	8	1,860	TTRS075RCT
90	92,0	69,8	10,1	4000	4	2,673	TTRS090RCT
110	112,0	85,4	12,3	4000	4	4,022	TTRS110RCT

Ø 20 - 63 mm with non-perforated aluminum foil

Ø 75 - 110 mm with perforated aluminum foil

job-order manufacture, delivery date 30 days

# Standard Products for Potable (Cold) and Hot Water and for Heating (I.)

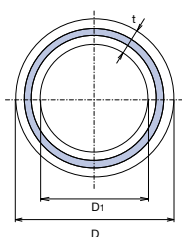

**PIPE FIBER BASALT PLUS 20-63 mm**  
**S 3,2 / SDR 7,4 / PN 28 (calculation)**  
**PIPE FIBER BASALT PLUS 75-125 mm**  
**S 4 / SDR 9 / PN 22 (calculation)**

D	D <sub>1</sub>	t	l	⊞	⚖	KOD
mm	mm	mm	mm	m	kg/m	
20	14,4	2,8	4000	100	0,153	TTRFB020TRCT
25	18,0	3,5	4000	60	0,239	TTRFB025TRCT
32	23,2	4,4	4000	40	0,385	TTRFB032TRCT
40	29,0	5,5	4000	24	0,599	TTRFB040TRCT
50	36,2	6,9	4000	16	0,941	TTRFB050TRCT
63	45,8	8,6	4000	12	1,471	TTRFB063TRCT
75	58,2	8,4	4000	8	1,764	TTRFB075TRCT
90	69,8	10,1	4000	4	2,546	TTRFB090TRCT
110	85,4	12,3	4000	4	3,781	TTRFB110TRCT
⊙ 125	97,0	14,0	4000	4	4,891	TTRFB125TRCT

⊙ job-order manufacture, delivery date 30 days

**NEW**

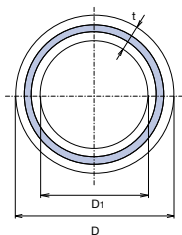
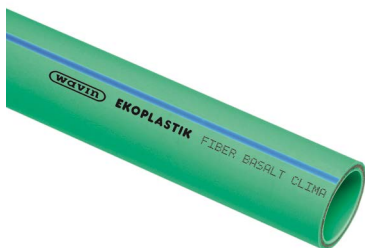

**PIPE FIBER BASALT CLIMA 20-25 mm**  
**S 4 / SDR 9 / PN 22 (calculation)**  
**PIPE FIBER BASALT CLIMA 32-125 mm**  
**S 5 / SDR 11 / PN 18 (calculation)**

D	D <sub>1</sub>	t	l	⊞	⚖	KOD
mm	mm	mm	mm	m	kg/m	
20	14,4	2,3	4000	100	0,128	TTRFBC020TRCT
25	18,0	2,8	4000	60	0,199	TTRFBC025TRCT
32	26,2	2,9	4000	40	0,269	TTRFBC032TRCT
40	32,6	3,7	4000	24	0,428	TTRFBC040TRCT
50	40,8	4,6	4000	16	0,664	TTRFBC050TRCT
63	51,4	5,8	4000	12	1,050	TTRFBC063TRCT
⊙ 75	61,4	6,8	4000	8	1,501	TTRFBC075TRCT
⊙ 90	73,6	8,2	4000	4	2,122	TTRFBC090TRCT
⊙ 110	90,0	10,0	4000	4	3,160	TTRFBC110TRCT
⊙ 125	102,2	11,4	4000	4	4,082	TTRFBC125TRCT

⊙ job-order manufacture, delivery date 30 days

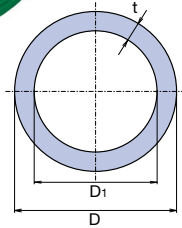

**PIPE IN COIL**

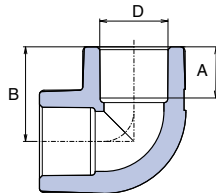
D	S	SDR	t	l	⚖️	KOD
mm			mm	m	kg/m	
16	3,2(16)	7,4	2,2	100	0,094	TTRK016P17
				200		TTRK016P16
20	5,0(10)	11	2,2	100	0,121	TTRK020P11
				200		TTRK020P10
20	3,2(16)	7,4	2,8	100	0,145	TTRK020P17
				200		TTRK020P16
16	2,5(20)	6	2,7	100	0,107	TTRK016P21
				200		TTRK016P20
20	2,5(20)	6	3,4	100	0,169	TTRK020P21
				200		TTRK020P20

**ELBOW 90 °**

D	A	B	⊞	⊞	⚖️	KOD
mm	mm	m	l.	ll.	kg/pc	
16	13,0	23,2	50	250	0,010	TKO01690XX
20	14,5	26,8	50	500	0,018	TKO02090XX
25	16,0	31,0	50	250	0,030	TKO02590XX
32	18,0	36,5	25	150	0,056	TKO03290XX
40	20,5	43,0	10	70	0,100	TKO04090XX
50	23,5	51,0	10	40	0,158	TKO05090XX
63	27,5	61,5	5	15	0,334	TKO06390XX
75	30,0	70,1	2	6	0,558	TKO07590XX
90	33,0	82,0	1	5	1,010	TKO09090XX
110	37,0	95,0		1	1,344	TKO11090XX
⊕ 125	40,0	105,0		1	1,640	TKO12590XX

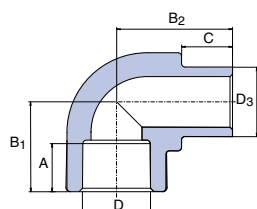
⊕ Information about delivery on request

**ELBOW 90 ° INTERNAL / EXTERNAL**

D,D3	A	B1	B2	C	⊞	⊞	⚖️	KOD
mm	mm	mm	mm	mm	l.	ll.	kg/pc	
16	13,0	21,3	25,0	12,0	50		0,006	TKO116XXXX
20	14,5	26,8	30,3	13,0	50	250	0,014	TKO120XXXX
25	16,0	31,0	35,0	14,0	50	200	0,024	TKO125XXXX
32	18,0	36,5	42,2	16,0	25	100	0,044	TKO132XXXX

# Standard Products for Potable (Cold) and Hot Water and for Heating (I.)

## ELBOW 45 °

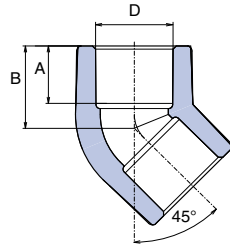

D	A	B	☐	☐	⚖️	KOD
mm	mm	m	I.	II.	kg/pc	
16	13,0	18,7		50	0,008	TKO01645XX
20	14,5	20,8	100	500	0,014	TKO02045XX
25	16,0	24,0	50	250	0,024	TKO02545XX
32	18,0	27,0	20	80	0,042	TKO03245XX
40	20,5	31,5	5	25	0,082	TKO04045XX
50	23,5	36,5	5	20	0,122	TKO05045XX
63	27,5	43,0	5	10	0,280	TKO06345XX
75	30,0	48,1	2	6	0,406	TKO07545XX
90	33,0	54,1	1	6	0,654	TKO09045XX
110	37,0	62,1		1	0,965	TKO11045XX

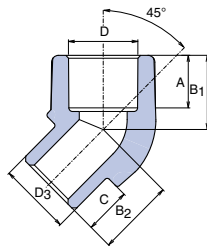

## ELBOW 45 ° INTERNAL / EXTERNAL

D	D3	A	B1	B2	D	☐	☐	⚖️	KOD
mm	mm	mm	mm	mm	mm	I.	II.	kg/pc	
16	16	13,0	18,7	18,7	12,0	50		0,008	TKO11645XX
20	20	14,5	20,8	21,5	13,0	10	100	0,012	TKO12045XX
25	25	16,0	24,0	24,0	14,0	10	100	0,026	TKO12545XX

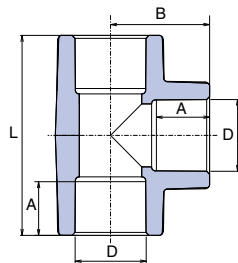

## TEE

D	A	B	L	☐	☐	⚖️	KOD
mm	mm	mm	mm	I.	II.	kg/pc	
16	13,0	23,2	46,4		50	0,012	TTK016XXXX
20	14,5	27,0	54,0	50	300	0,022	TTK020XXXX
25	16,0	32,0	60,0	50	200	0,038	TTK025XXXX
32	18,0	35,7	70,0	20	100	0,070	TTK032XXXX
40	20,5	38,5	86,2	10	50	0,124	TTK040XXXX
50	23,5	51,0	102,0	5	30	0,196	TTK050XXXX
63	27,5	61,5	123,0	5	15	0,430	TTK063XXXX
75	30,0	70,1	140,2	1	5	0,644	TTK075XXXX
90	33,0	83,1	166,2		1	1,134	TTK090XXXX
110	37,0	99,1	198,2		1	1,962	TTK110XXXX
⊕ 125	40,0	105,0	210,0		1	2,030	TTK125XXXX

⊕ Information about delivery on request



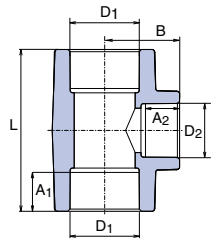

**REDUCING TEE**

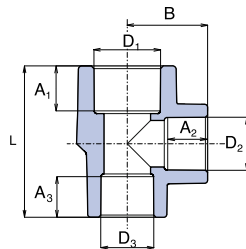
D <sub>1</sub>	D <sub>2</sub>	A <sub>1</sub>	A <sub>2</sub>	L	B				KOD
mm	mm	mm	mm	mm	mm	I.	II.	kg/pc	
20	16	14,5	13,0	53,0	23,0	50		0,018	TTKR02016X
25	20	16,0	14,5	55,0	29,0	50	200	0,032	TTKR02520X
32	20	18,0	14,5	67,0	34,4	50	150	0,052	TTKR03220X
32	25	18,0	16,0	73,0	34,4	25	100	0,062	TTKR03225X
40	20	20,5	14,5	64,5	38,0	20	60	0,082	TTKR04020X
40	25	20,5	16,0	66,0	40,2	10	50	0,090	TTKR04025X
40	32	20,5	18,0	86,0	41,5	10	40	0,132	TTKR04032X
50	25	23,5	16,0	77,0	43,4	5	15	0,138	TTKR05025X
50	32	23,5	18,0	84,0	46,0	5	30	0,152	TTKR05032X
50	40	23,5	20,5	91,4	47,4	5	15	0,176	TTKR05040X
63	25	27,5	16,0	85,0	49,9	5	10	0,239	TKTR06325X
63	32	27,5	18,0	92,0	52,0	5	15	0,290	TTKR06332X
63	40	27,5	20,5	100,0	54,6	5	15	0,306	TTKR06340X
63	50	27,5	23,5	110,0	57,2	5	15	0,340	TTKR06350X

**REDUCING TEE**

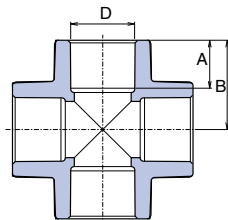
D <sub>1</sub>	D <sub>2</sub>	D <sub>3</sub>	A <sub>1</sub>	A <sub>2</sub>	A <sub>3</sub>	L	B				KOD
mm	mm	mm	mm	mm	mm	mm	mm	I.	II.	kg/pc	
25	20	20	16,0	14,5	14,5	55,2	29,3	10	50	0,028	TTKR0252020
32	20	20	18,0	14,5	14,5	57,3	32,8	10	50	0,040	TTKR0322020
32	20	25	18,0	14,5	16,0	58,9	32,8	10	50	0,044	TTKR0322520
32	25	25	18,0	18,0	16,0	66,0	34,4	10	50	0,052	TTKR0322525

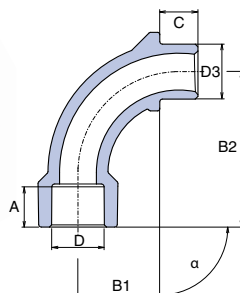

**CROSS PIECE**

D <sub>3</sub>	A	B <sub>1</sub>				KOD
mm	mm	mm	I.	II.	kg/pc	
20	14,5	26,3	25		0,024	TKRI020XXX
25	16,0	30,1	25		0,042	TKRI025XXX
32	18,0	35,0	10	40	0,070	TKRI032XXX
40	20,5	42,0	10	30	0,128	TKRI040XXX

**BEND**

D	D <sub>3</sub>	A	B <sub>1</sub>	B <sub>2</sub>	C	α				KOD
mm	mm	mm	mm	mm	mm	°	I.	II.	kg/pc	
20	20	14,5	37,0	56,0	13,6	90°	25	100	0,022	TO02090XXX
25	25	16,0	45,0	67,0	14,6	90°	10	100	0,036	TO02590XXX

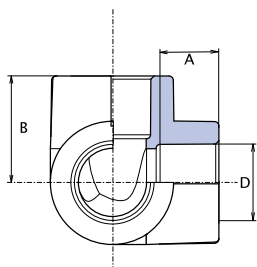
# Standard Products for Potable (Cold) and Hot Water and for Heating (I.)



## THREE-WAY ELBOW

D	A	B	☐	☐	⚖️	KOD
mm	mm	mm	I.	II.	kg/pc	
20	14,5	26,8	10	50	0,020	TKOT020XXX
25	16,0	29,5	10	40	0,032	TKOT025XXX
32	18,0	35,0	5	20	0,062	TKOT032XXX
40	20,5	41,5	5	15	0,108	TKOT040XXX

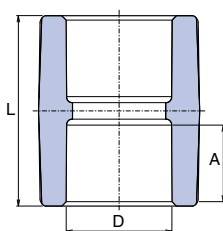

## SOCKET

D	A	L	☐	☐	⚖️	KOD
mm	mm	mm	I.	II.	kg/pc	
16	13,0	33,0		50	0,006	TNA016XXXX
20	14,5	34,6	50	500	0,010	TNA020XXXX
25	16,0	37,8	50	250	0,018	TNA025XXXX
32	18,0	40,0	25	150	0,034	TNA032XXXX
40	20,5	48,0	20	80	0,056	TNA040XXXX
50	23,5	53,0	10	70	0,082	TNA050XXXX
63	27,5	65,0	5	30	0,118	TNA063XXXX
75	30,0	73,4	1	5	0,314	TNA075XXXX
90	33,0	79,2		1	0,470	TNA090XXXX
110	37,0	88,2		1	0,782	TNA110XXXX
⊙ 125	40,0	86,0		1	0,745	TNA125XXXX

⊙ Information about delivery on request

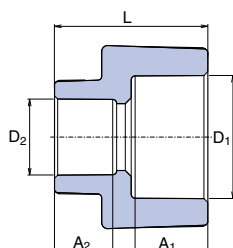

## REDUCER

D <sub>1</sub>	D <sub>2</sub>	A <sub>1</sub>	D <sub>2</sub>	L	☐	☐	⚖️	KOD
mm	mm	mm	mm	mm	I.	II.	kg/pc	
25	20	16,0	14,5	34,0	50	450	0,014	TRE02520XX
32	20	18,0	14,5	39,0	50	250	0,026	TRE03220XX
32	25	18,0	16,0	39,5	50	250	0,028	TRE03225XX

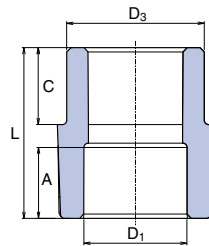
**REDUCER INTERNAL / EXTERNAL**

D3	D1	A	L	C	☐	☐	⚖	KOD
mm	mm	mm	mm	mm	I.	II.	kg/pc	
20	16	13,0	32,5	13,0	50		0,006	TRE12016XX
25	20	14,5	34,0	14,0	50	500	0,010	TRE12520XX
32	20	14,5	40,0	16,0	50	200	0,016	TRE13220XX
32	25	16,0	39,5	16,0	50	300	0,018	TRE13225XX
40	20	14,5	47,0	18,5	10	50	0,024	TRE14020XX
40	25	16,0	45,4	18,5	10	50	0,026	TRE14025XX
40	32	18,0	48,2	18,5	20	60	0,034	TRE14032XX
50	25	16,0	21,3	41,3	10	50	0,042	TRE15025XX
50	32	18,0	55,5	22,0	10	50	0,052	TRE15032XX
50	40	20,5	52,0	22,0	10	50	0,048	TRE15040XX
63	25	16,0	25,3	49,3	5	10	0,070	TRE16325XX
63	32	18,0	62,5	27,0	5	10	0,080	TRE16332XX
63	40	20,5	58,5	27,0	5	10	0,078	TRE16340XX
63	50	23,5	58,5	27,0	5	10	0,078	TRE16350XX
75	40	20,5	64,5	29,5	5	20	0,116	TRE17540XX
75	50	23,5	64,5	29,5	5	20	0,120	TRE17550XX
75	63	27,5	71,5	29,5	1	5	0,210	TRE17563XX
90	63	27,5	64,5	34,0	1		0,221	TRE19063XX
90	75	30,0	78,0	34,0	1		0,290	TRE19075XX
110	75	30,0	60,0	40,0	1		0,268	TRE111075X
110	90	33,0	87,0	40,0	1		0,502	TRE111090X
⊙125	110	40,0	35,0	103,0	1		0,678	TRE1125110

⊙ Information about delivery on request

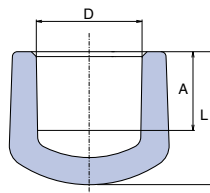
**BLANKING PLUG**

D	A	B	☐	☐	⚖	KOD
mm	mm	mm	I.	II.	kg/pc	
16	13,5	20,9	50		0,004	TZA016XXXX
20	14,5	24,5	50	150	0,008	TZA020XXXX
25	16,0	28,0	50	150	0,014	TZA025XXXX
32	18,0	33,0	20	100	0,026	TZA032XXXX
40	20,5	39,5	5	25	0,048	TZA040XXXX
50	23,5	47,0	5	25	0,078	TZA050XXXX
63	27,5	53,5	5		0,170	TZA063XXXX
75	30,0	60,0	5		0,262	TZA075XXXX
90	33,0	69,0	1		0,425	TZA090XXXX
110	37,0	79,0	1		0,715	TZA110XXXX

# Standard Products for Potable (Cold) and Hot Water and for Heating (I.)

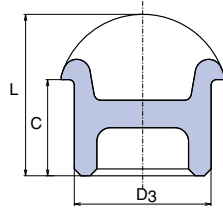

## BLANKING PLUG INTERNAL

D <sub>3</sub>	C	L	☰	☰	⚖	KOD
mm	mm	mm	I.	II.	kg/pc	
20,0	14,5	23,5	40	160	0,004	TZA120XXXE

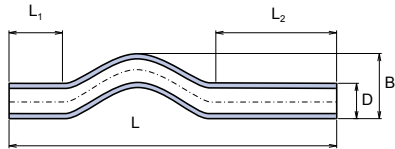

## CROSSOVER S 2,5 / PN 20 / SDR 6

D <sub>3</sub>	S	B	L	L <sub>1</sub>	L <sub>2</sub>	☰	☰	⚖	KOD
mm (PN20)	mm	mm	mm	mm	mm	I.	II.	kg/pc	
16	2,5 (20)	35,0	400,0	80,0	180,0	10	0,044		TKR016P20X
20	2,5 (20)	47,0	400,0	80,0	180,0	10	50	0,070	TKR020P20X
25	2,5 (20)	52,0	400,0	80,0	120,0	10	50	0,110	TKR025P20X
32	2,5 (20)	65,0	390,0	64,0	106,0	5	20	0,174	TKR032P20X
40	2,5 (20)	65,0	390,0	64,0	106,0	5	20	0,268	TKR040P20X

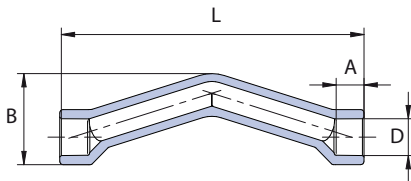

## CROSSOVER WITH SOCKET

D	S	A	B	L	☰	☰	⚖	KOD
mm (PN20)	mm	mm	mm	mm	I.	II.	kg/pc	
20	2,5 (20)	14,5	33,4	160,0	10	50	0,041	TKRH020P20
25	2,5 (20)	16,0	44,2	200,0	10	50	0,089	TKRH025P20

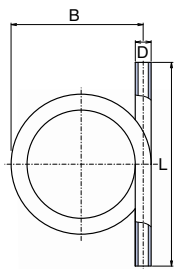
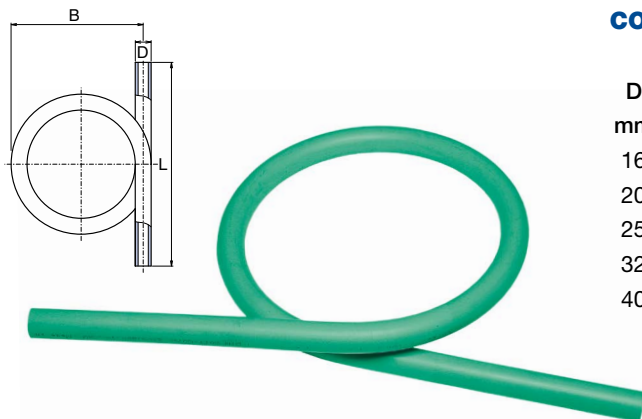

## COMPENSATION PIPE S 2,5 / PN 20 / SDR 6

D	S	B	L	☰	⚖	KOD
mm	(PN20)	mm	mm		kg/pc	
16	2,5 (20)	185,0	320,0	10	0,090	TKS016P20X
20	2,5 (20)	200,0	450,0	10	0,174	TKS020P20X
25	2,5 (20)	210,0	440,0	10	0,264	TKS025P20X
32	2,5 (20)	230,0	410,0	5	0,430	TKS032P20X
40	2,5 (20)	290,0	450,0	3	0,786	TKS040P20X

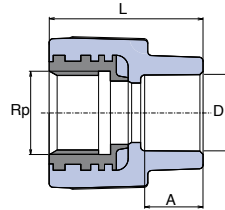
**REDUCING SLEEVE WITH METAL FEMALE THREAD**

D	Rp	A	L	☒	☒	⚖	KOD
mm	mm	mm	mm	I.	II.	kg/pc	
16	1/2"	13,0	38,0	10	50	0,050	TZI01620XX
20	1/2"	14,5	39,0	10	250	0,056	TZI02020XX
20	3/4"	14,5	42,0	10	100	0,072	TZI02025XX
25	1/2"	16,0	40,5	10	50	0,062	TZI02520XX
25	3/4"	16,0	47,0	10	100	0,075	TZI02525XX
32	3/4"	18,0	45,0	10	30	0,081	TZI03225XX
32	1"	18,0	57,0	10	60	0,148	TZI03232OK
40	5/4"	20,5	65,0	5	10	0,260	TZI04040XX
50	6/4"	23,5	69,0		4	0,328	TZI05050XX
63	2"	27,5	76,0		2	0,616	TZI06363XX

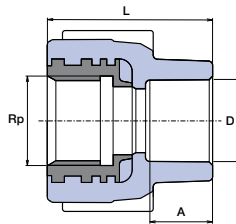
**REDUCING SLEEVE WITH METAL FEMALE THREAD WITH CROSS**

D	Rp	A	L	☒	☒	⚖	KOD
mm	mm	mm	mm	I.	II.	kg/pc	
20	1/2"	14,5	42,0	10	100	0,058	TZI02020KX

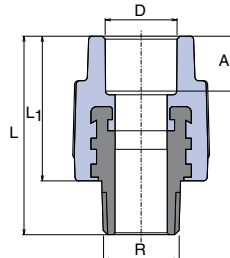
**REDUCING SLEEVE WITH METAL MALE THREAD**

D	R	A	L	L <sub>1</sub>	☒	☒	⚖	KOD
mm	mm	mm	mm	mm	I.	II.	kg/pc	
16	1/2"	13,0	52,0	37,5	10	50	0,064	TZE01620XX
20	1/2"	14,5	53,5	39,0	10	150	0,062	TZE02020XX
20	3/4"	14,5	58,0	40,0	10	100	0,096	TZE02025XX
25	1/2"	16,0	55,5	41,0	10	60	0,066	TZE02520XX
25	3/4"	16,0	59,0	41,0	20	100	0,098	TZE02525XX
32	3/4"	18,0	60,0	44,0	10	30	0,105	TZE03225XX
32	1"	18,0	62,5	46,0	10	60	0,170	TZE03232XX
32	1"	18,0	69,5	42,0	10	60	0,204	TZE03232OK
40	5/4"	20,5	80,0	48,0	5	10	0,312	TZE04040XX
50	6/4"	23,5	81,6	54,0		4	0,460	TZE05050XX
63	2"	27,5	101,0	63,5		2	0,758	TZE06363XX
75	2 1/2"	30,0	110,0	69,7		1	1,150	TZE07575XX
90	3"	33,0	130,0	85,0		1	1,774	TZE09090XX

# Standard Products for Potable (Cold) and Hot Water and for Heating (I.)

## METAL REDUCER WITH CAP NUT

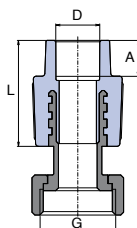

D	G	A	L	☐	☐	⚖	KOD
mm		mm	mm	I.	II.	kg/pc	
16	1/2"	13,0	32,0	10		0,044	TZM01620XX
16	3/4"	13,0	32,0	10		0,082	TZM01625XX
20	1/2"	14,5	40,0	20	100	0,048	TZM02020XX
20	3/4"	14,5	39,0	20	100	0,082	TZM02025XX
20	1"	14,5	39,0	5	10	0,152	TZM02032XX
25	3/4"	16,0	41,1	20	100	0,086	TZM02525XX
25	1"	16,0	41,0	4		0,154	TZM02532XX
32	5/4"	18,0	48,0	2		0,254	TZM03240XX
⊙ PMD							
20	3/4"	14,5	39,0	10		0,084	TZMD02025X
⊙ PMD – cap nut with the hole for the seal							

## ELBOW 90° WITH METAL FEMALE THREAD

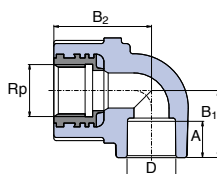

D	Rp	A	B <sub>1</sub>	B <sub>1</sub>	☐	☐	⚖	KOD
mm		mm	mm	mm	I.	II.	kg/pc	
16	1/2"	13,0	25,2	31,0	10	50	0,062	TKOI01620X
20	1/2"	14,5	27,0	34,5	10	100	0,062	TKOI02020X
20	3/4"	14,5	27,0	40,0	10	50	0,082	TKOI02025X
25	1/2"	16,0	31,0	36,0	10	50	0,070	TKOI02520E
25	3/4"	16,0	30,0	41,0	10	100	0,090	TKOI02525X
32	1"	18,0	36,0	51,0	5	50	0,168	TKOI03232X

## ELBOW 90° WITH METAL MALE THREAD

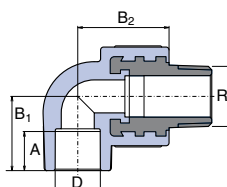

D	Rp	A	B <sub>1</sub>	B <sub>1</sub>	☐	☐	⚖	KOD
mm		mm	mm	mm	I.	II.	kg/pc	
16	1/2"	13,0	25,2	31,0	10	50	0,074	TKOE01620X
20	1/2"	14,5	27,0	34,5	10	100	0,074	TKOE02020X
20	3/4"	14,5	27,0	39,0	10	50	0,112	TKOE02025X
25	1/2"	16,0	31,0	36,0	10	50	0,082	TKOE02520E
25	3/4"	16,0	30,0	39,0	10	80	0,116	TKOE02525X
32	1"	18,0	36,0	41,6	5	40	0,118	TKOE03232X

## SOCKET WITH DRAIN VALVE INTERNAL / EXTERNAL

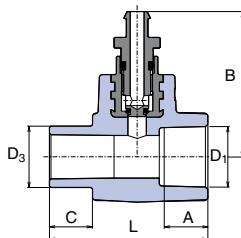

D	D <sub>3</sub>	A	L	B	C	☐	☐	⚖	KOD
mm	mm	mm	mm	mm	mm	I.	II.	kg/pc	
20	20	14,5	33,0	30,3	13,0	10	20	0,054	TNAV120XX
25	25	16,0	54,0	49,7	14,0	5	15	0,064	TNAV125XX
32	32	18,0	59,0	53,2	16,0	5	10	0,084	TNAV132XX

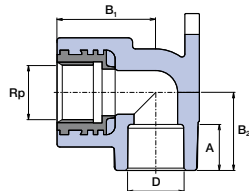
**ELBOW 90° FOR WALL MOUNTING**

D	Rp	A	B <sub>1</sub>	B <sub>2</sub>				KOD
mm		mm	mm	mm	I.	II.	kg/pc	
16	1/2"	13,0	32,0	23,2	10	60	0,064	TNK016XXXX
20	1/2"	14,5	34,0	26,8	10	150	0,068	TNK020XXXX
25	1/2"	16,0	36,0	27,5	10	50	0,072	TNK02520XX
25	3/4"	16,0	40,0	40,0	10	50	0,098	TNK025XXXX

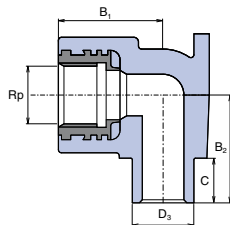
**ELBOW 90° FOR WALL MOUNTING  
INTERNAL / EXTERNAL**

D <sub>3</sub>	Rp	B <sub>1</sub>	B <sub>2</sub>	C				KOD
mm		mm	mm	mm	I.	II.	kg/pc	
20	1/2"	35,0	35,0	11,0	10	120	0,068	TNK120XXXX

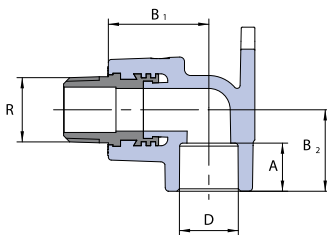
**ELBOW 90° FOR WALL MOUNTING WITH METAL  
MALE THREAD**

D	R	B <sub>1</sub>	B <sub>2</sub>	A				KOD
mm		mm	mm	mm	I.	II.	kg/pc	
20	1/2"	47,5	27	14,5	10	50	0,072	TNKE02020X

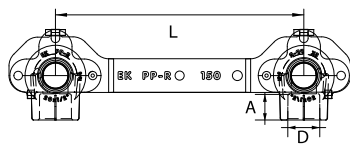
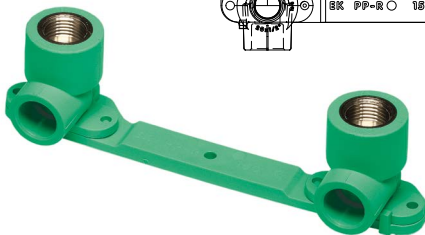
**WALL ELBOWS WITH HOLDER**

D	A	L				KOD
mm	mm	mm	I.	II.	kg/pc	
20	14,5	150	10	50	0,162	TNKD02020X

**HOLDER FOR WALL ELBOWS**

D	L				KOD
mm	mm	I.	II.	kg/pc	
20	150	10	50	0,026	TDNKXXXXXX

# Standard Products for Potable (Cold) and Hot Water and for Heating (I.)

## TEE WITH TAP CONNECTOR

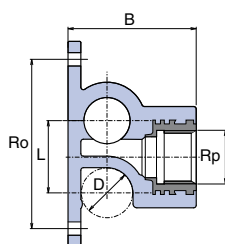

D	Rp	B	Ro	L	☐ I.	☐ II.	⚖ kg/pc	KOD
20	1/2"	50,0	66,0	28,5	20	100	0,080	TNKP020XXX
25	1/2"	56,0	76,0	33,5	10	50	0,090	TNKP02520X

## WALL MOUNTING GROUP WITH TAP CONNECTORS

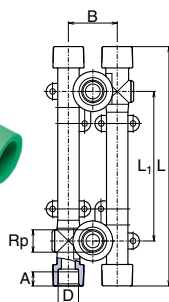

D	Rp	A	B	⊕ L <sub>1</sub>	L	☐ I.	☐ II.	⚖ kg/pc	KOD
20	1/2"	14,5	46,0	105/130/145	229,0	1	10	0,220	TNKK020XXX
25	1/2"	16,0	51,0	110/125/140	230,0	1	10	0,268	TNKK025XXX

⊕ L<sub>1</sub> - extension 100, 135, 150 mm, it is necessary to set right with eccentric parts.

## TEE WITH METAL FEMALE THREAD

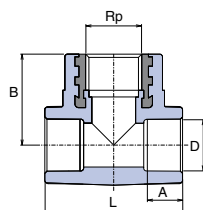

D	Rp	A	L <sub>1</sub>	B	☐ I.	☐ II.	⚖ kg/pc	KOD
20	1/2"	14,5	51,5	34,0	10	100	0,068	TTKI02020X
25	1/2"	16,0	80,0	40,0	10	100	0,076	TTKI02520X
25	3/4"	16,0	80,0	40,0	5	30	0,094	TTKI02525X
32	1/2"	18,0	71,0	40,5	5	25	0,106	TTKI03220X
32	3/4"	18,0	71,0	42,0	5	25	0,118	TTKI03225X
32	1"	18,0	80,0	55,0	5	20	0,186	TTKI03232X

## TEE WITH METAL MALE THREAD

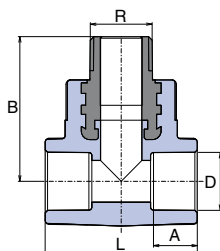

D	R	A	L <sub>1</sub>	B	☐ I.	☐ II.	⚖ kg/pc	KOD
20	1/2"	14,5	51,5	48,5	10	100	0,080	TTKE02020X
20	3/4"	14,5	60,0	50,0	5	30	0,118	TTKE02025X
25	1/2"	16,0	60,0	51,0	10	80	0,088	TTKE02520X
25	3/4"	16,5	65,0	52,5	5	25	0,122	TTKE02525X
32	3/4"	18,0	71,0	58,3	5	20	0,146	TTKE03225X
32	1"	18,0	80,0	60,0	5	20	0,208	TTKE03232X



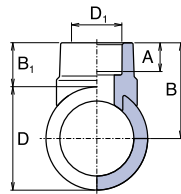

**ALL PLASTIC WELD IN SADDLE**

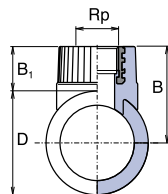
D	D <sub>1</sub>	A	B <sub>1</sub>	B	☰	☷	⚖️	KOD
mm	mm	mm	mm	mm	l.	ll.	kg/pc	
63	32	18,0	27,0	58,5	10	50	0,034	TNS06332XX
75	32	18,0	27,0	64,5	10	50	0,032	TNS07532XX
90	32	18,0	27,0	72,0	10	50	0,034	TNS09032XX
110	32	18,0	25,7	80,7	5	40	0,044	TNS11032XX
110	40	21,0	25,7	80,7	5	40	0,048	TNS11040XX

**WELD IN SADDLE WITH METAL FEMALE THREAD**

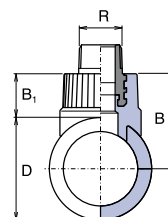
D	Rp	B <sub>1</sub>	B	☰	⚖️	KOD
mm		mm	mm		kg/pc	
63	3/4"	27,0	58,5	10	0,084	TNSI06325X
75	3/4"	27,0	64,5	10	0,084	TNSI07525X
90	3/4"	27,0	72,0	10	0,084	TNSI09025X

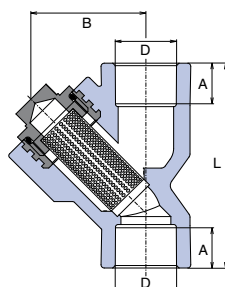

**WELD IN SADDLE WITH METAL MALE THREAD**

D	R	B <sub>1</sub>	B	☰	⚖️	KOD
mm		mm	mm		kg/pc	
63	3/4"	44,8	76,3	10	0,112	TNSE06325X
75	3/4"	44,8	82,3	10	0,110	TNSE07525X
90	3/4"	44,8	89,8	10	0,110	TNSE09025X

**FILTER**

D	B	L	☰	☷	⚖️	KOD
mm	mm	mm	l.	ll.	kg/pc	
20	45,0	76,0	5	40	0,116	TFI020XXXX
25	45,0	82,0	5	40	0,134	TFI025XXXX
32	55,0	95,0	5	40	0,234	TFI032XXXX

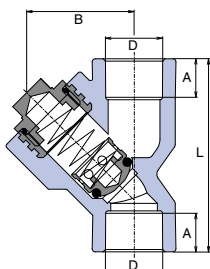
# Standard Products for Potable (Cold) and Hot Water and for Heating (I.)



## BACK FLOW VALVE

D	B	L	☐	☐	⚖️	KOD
mm	mm	mm	I.	II.	kg/pc	
20	45,0	76,0	5	40	0,136	TZKL020XXX
25	45,0	82,0	5	40	0,154	TZKL025XXX
32	55,0	95,0	5	40	0,266	TZKL032XXX

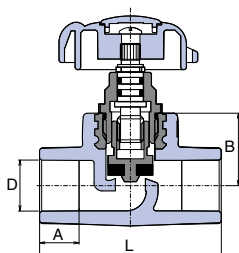

## STRAIGHT - WAY VALVE

D	A	B	L	☐	☐	⚖️	KOD
mm	mm	mm	mm	I.	II.	kg/pc	
20	14,5	27,5	69,0	10	50	0,140	TVE020XXXX
25	16,0	30,0	80,0	10	30	0,192	TVE025XXXX
32	18,0	39,0	89,0	5	15	0,380	TVE032XXXX
40	20,5	41,0	112,0		5	0,542	TVE040XXXX
50	23,5	48,0	136,0		1	0,732	TVE050XXXX
63	27,5	60,0	162,0		1	1,330	TVE063XXXX

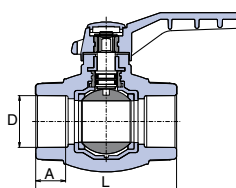

## BALL TAP PLASTIC

D	A	L	☐	☐	⚖️	KOD
mm	mm	mm	I.	II.	kg/pc	
16	13,0	59,5	10	50	0,092	TVEK016XXX
20	14,5	65,0	10	50	0,116	TVEK020XXX
25	16,0	71,0	10	40	0,168	TVEK025XXX
32	18,0	85,0	10	20	0,294	TVEK032XXX
40	20,5	100,0	5	10	0,544	TVEK040XXX
50	23,5	115,0	1	5	0,874	TVEK050XXX
63	27,5	134,0	1	5	1,278	TVEK063XXX

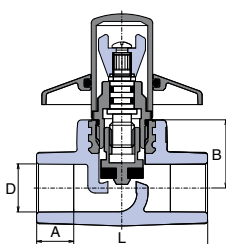

## SHUT OFF VALVE STRAIGHT WITH CHROME COVER

D	A	B	L	☐	☐	⚖️	KOD
mm	mm	mm	mm	I.	II.	kg/pc	
20	14,5	27,5	69,0	5	20	0,208	TVEPLK020X
25	14,5	30,0	80,0	5	20	0,270	TVEPLK025X

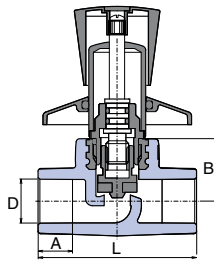
**SHUT OFF VALVE DELUXE STRAIGHT WITH CHROME HANDLE**

D	A	B	L	☒	☒	⚖	KOD
mm	mm	mm	mm	I.	II.	kg/pc	
20	14,5	27,5	69,0	5	20	0,338	TVEPLR020X
25	14,5	30,0	80,0	5	20	0,392	TVEPLR025X

**VALVE EXTENSION D 20, 25 mm**

☒	⚖	KOD
	kg/pc	
1	0,071	VEPL020XXX

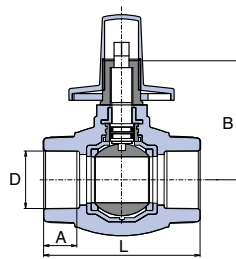
 extension for shut off valves straight  $\varnothing$  20 a 25 mm

**SHUT OFF BALL TAP WITH CHROME COVER**

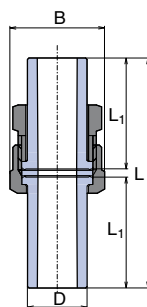
D	A	B	L	☒	☒	⚖	KOD
mm	mm	mm	mm	I.	II.	kg/pc	
20	14,5	67,0	65,0	5	20	0,254	TVEKPLK020
25	16,5	65,0	71,0	5	20	0,334	TVEKPLK025

**COUPLING WITH NUT**

D	B	L	L <sub>1</sub>	☒	☒	⚖	KOD
mm	mm	mm	mm	I.	II.	kg/pc	
20	30,0	82,0	40,0	20	100	0,088	TRS020XXXX
25	38,0	82,0	40,0	20	100	0,142	TRS025XXXX
32	46,0	92,0	45,0	10	50	0,212	TRS032XXXX
40	58,0	112,0	55,0	5	5	0,288	TRS040XXXX

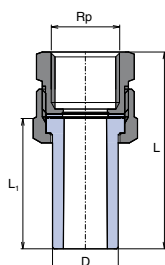
# Standard Products for Potable (Cold) and Hot Water and for Heating (I.)



## SCREW UNION - FEMALE

D	Rp	L	L <sub>1</sub>	⊞	⊞	⚖	KOD
mm		mm	mm	I.	II.	kg/pc	
20	1/2"	60,0	40,0	10	100	0,086	TSI02020XX
25	3/4"	62,0	40,0	10	70	0,136	TSI02525XX
32	1"	70,0	45,0	10	50	0,220	TSI03232XX

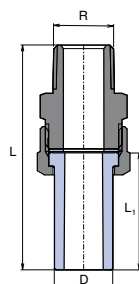

## SCREW UNION - MALE

D	R	L	L <sub>1</sub>	⊞	⊞	⚖	KOD
mm		mm	mm	I.	II.	kg/pc	
20	1/2"	77,0	40,0	10	100	0,118	TSE02020XX
25	3/4"	80,0	40,0	10	50	0,196	TSE02525XX
32	1"	92,0	45,0	10	40	0,324	TSE03232XX

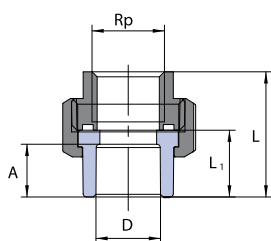

## SCREW UNION WITH SOCKET - FEMALE

D	Rp	L	L <sub>1</sub>	⊞	⊞	⚖	KOD
mm		mm	mm	I.	II.	kg/pc	
20	1/2"	37,5	19,5	10	100	0,122	TSHI02020X
25	3/4"	46,5	23,0	10	70	0,213	TSHI02525X

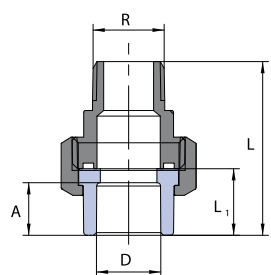

## SCREW UNION WITH SOCKET - MALE

D	Rp	L	L <sub>1</sub>	⊞	⊞	⚖	KOD
mm		mm	mm	I.	II.	kg/pc	
20	1/2"	52,5	19,5	10	100	0,142	TSHE02020X
25	3/4"	59,0	23,0	10	70	0,223	TSHE02525X

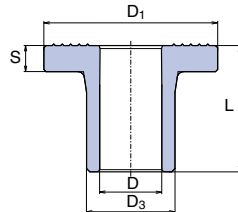
**FLANGE ADAPTOR**

D <sub>3</sub>	L	D <sub>1</sub>	S	D	☐	☐	⚖️	KOD
mm	mm	mm	mm	mm	l.	ll.	kg/pc	
40	58,0	80,0			2	10	0,072	TLN040XXXX
50	60,0	90,0	12,5		2	10	0,102	TLN050XXXX
63	62,0	105,0	13,5		1	10	0,156	TLN063XXXX
75	73,0	123,0	14,7		1	5	0,244	TLN075XXXX
90	92,0	140,0	17,0			1	0,400	TLN090XXXX
110	103,0	160,0	19,0			1	0,618	TLN110XXXX
165	63,0	188,0	20,0	⊕ 125	1		0,697	TLN125XXXX

⊕ Information about delivery on request

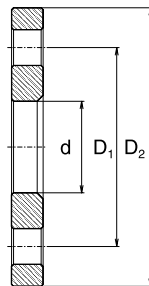
**FLANGE**

	D <sub>1</sub>	D <sub>2</sub>	d	⊕ Y	☐	⚖️	KOD
	mm	mm	mm			kg/pc	
40 / DN32	100,0	140,0	46,0	4	1	1,660	PRI040NXXX
50 / DN40	110,0	150,0	54,0	4	1	1,802	PRI050NXXX
63 / DN50	125,0	165,0	66,0	4	1	2,414	PRI063NXXX
75 / DN65	145,0	185,0	83,0	8	1	2,978	PRI075NXXX
90 / DN80	160,0	200,0	94,0	8	1	3,490	PRI090NXXX
110 / DN100	180,0	220,0	114,0	8	1	4,098	PRI110NXXX
125 / DN150	210,0	250,0	166,0	8	1	4,450	PRI125NXXX

⊕ Y – number of bore holes

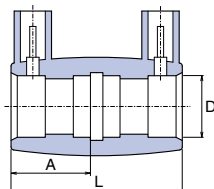
**ELECTRO - FUSION SOCKET**

D	A	L	☐	⚖️	KOD
mm	mm	mm		kg/pc	
20	26,5	55,0	1	0,030	ENA020XXXX
25	26,5	55,0	1	0,038	ENA025XXXX
32	25,0	52,0	1	0,044	ENA032XXXX
40	25,0	52,0	1	0,060	ENA040XXXX
50	25,0	52,0	1	0,076	ENA050XXXX
63	30,0	63,0	1	0,120	ENA063XXXX
75	33,0	70,0	1	0,158	ENA075XXXX
90	36,0	75,0	1	0,206	ENA090XXXX
110	40,0	87,0	1	0,364	ENA110XXXX

delivered in grey colour only

# Complete Offer of Fittings for Gypsum Wall Mounting (I.)

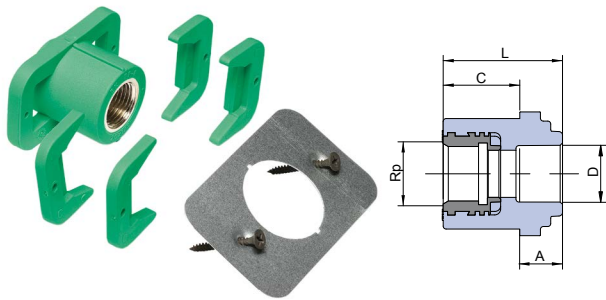

## REDUCING SLEEVE FOR GYPSUM WALL MOUNTING

D	Rp	A	C	L	📦	📦	⚖️	KOD
mm		mm	mm	mm	I.	II.	kg/pc	
20	1/2"	14,5	26,0	40,5	1	10	0,102	TZS02020X

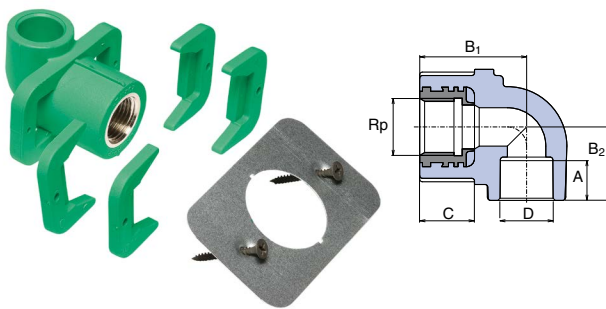

## ELBOW FOR GYPSUM WALL MOUNTING

B	Rp	A	B <sub>1</sub>	B <sub>2</sub>	C	📦	📦	⚖️	KOD
mm		mm	mm	mm	mm	I.	II.	kg/pc	
20	1/2"	15	44,0	27,0	26,0	1	10	0,114	TNKS020SX

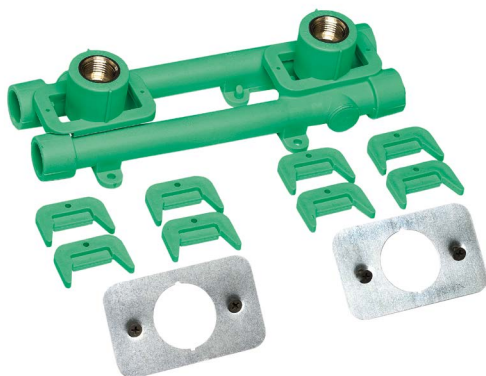

## WALL MOUNTING GROUP WITH TAP CONNECTORS FOR GYPSUM WALL

D	Rp	A	B	L <sub>1</sub>	L	📦	⚖️	KOD
mm		mm	mm	mm	mm		kg/pc	
20	1/2"	14,5	49,0	100/135/150	234,0	10	0,320	TNKK020SXX

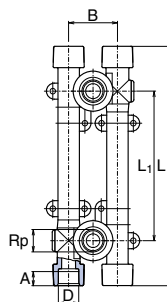

## Standard Products only for Potable (Cold) Water (II.)

### STRAIGHT - WAY VALVE WITH DRAIN VALVE

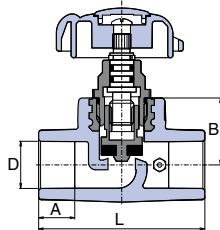

D mm	A mm	B mm	L mm	☐	⚖️ kg/pc	KOD
<b>right</b>						
40	20,5	41,0	112,0	1	0,578	TVEV040PXX
50	23,5	48,0	136,0	1	0,788	TVEV050PXX
63	27,5	60,0	162,0	1	1,388	TVEV063PXX
<b>left</b>						
40	20,5	41,0	112,0	1	0,572	TVEV040LXX
50	23,5	48,0	136,0	1	0,754	TVEV050LXX
63	27,5	60,0	162,0	1	1,416	TVEV063LXX

job-order manufacture, delivery date 30 days

## Product for Temporary Use (non Standard) (III.)

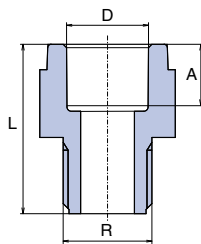

### ALL-PLASTIC REDUCER MALE THREAD

D mm	R	A mm	L mm	☐ I.	☐ II.	⚖️ kg/pc	KOD
20	1/2"	14,5	40,0	50	200	0,014	SDG02020XX
20	3/4"	14,5	38,0	50		0,012	SDG02025XX
25	3/4"	16,0	42,0	50		0,020	SDG02525XX
32	1"	18,0	54,0	25		0,038	SDG03232XX
40	5/4"	20,5	62,0	10		0,074	SDG04040XX
50	6/4"	23,5	63,0	10		0,094	SDG05050XX
63	2"	27,5	81,9	5		0,194	SDG06363XX

delivered in grey colour only

## Accessories (IV.)

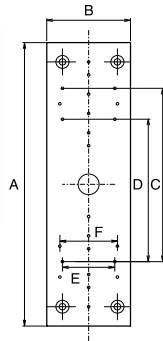
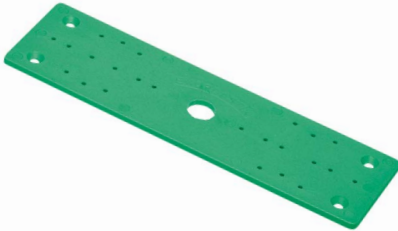

### ASSEMBLY PLATE FOR ELBOW 90 ° FOR WALL MOUNTING

A	B	C	D	E	F	☰	☰	⚖	KOD
mm	mm	mm	mm	mm	mm	I.	II.	kg/pc	
220,0	64,0	135,0	110,0	45,0	40,0	10	50	0,058	DNPXXXXXXX

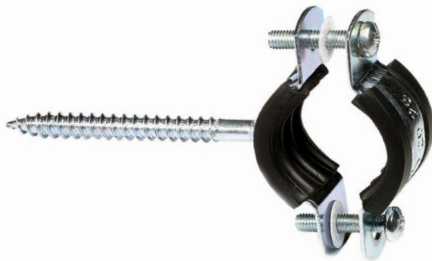

### METAL SLEEVE (WITH WOOD SCREW)

D	☰	☰	⚖	KOD
mm	I.	II.	kg/pc	
20-25	25	100	0,056	PRK02025XX
32-40	25	100	0,074	PRK03240XX
50-63	5	50	0,124	PRK06350XX



### METAL SLEEVE (SCREW / NUT)

D	NUT	SCREW	☰	☰	⚖	KOD
mm	mm	mm	I.	II.	kg/pc	
48 - 53	M8/10		5	50	0,078	PRKB04853X
72 - 78	M8/10		5	10	0,146	PRKB07278X
87 - 92	M8/10		5	10	0,180	PRKB08792X
102 - 116	M8/10		5	10	0,238	PRKB102116
			M8/100	10	0,023	VRUTM8100X



### PLASTIC CLIP

D	☰	☰	⚖	KOD
mm	I.	II.	kg/pc	
16	50	300	0,004	PRE016XXXX
20	50	500	0,004	PRE020XXXX
25	50	500	0,006	PRE025XXXX
32	50	300	0,008	PRE032XXXX
⊙ 40	1	50	0,016	PRP040XXXX
⊙ 50	1	25	0,034	PRP050XXXX
⊙ 63	1	25	0,046	PRP063XXXX
⊙ 75		1	0,084	PRP075XXXX
⊙ 90		1	0,114	PRP090XXXX
⊙ 110		1	0,136	PRP110XXXX

⊙ with tape

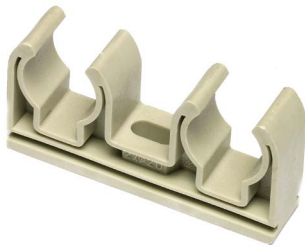

**PLASTIC DOUBLE CLIP**

D	📦	⚖️	KOD
mm		kg/pc	
2x20	1	0,016	PRDV0202XX
2x25	1	0,022	PRDV0252XX

delivered in grey colour only

**WELDING MACHINE ELECTRONIC  
(FOR NON-PAIRED ADAPTER)**

	W	📦	⚖️	KOD
			kg/pc	
RSP 2a	800	1	1,328	SVARSP2AXEL

**WELDING MACHINE ELECTRONIC  
(FOR PAIRED ADAPTER)**

	W	📦	⚖️	KOD
			kg/pc	
RSP 2aPm	800	1	1,428	SVARSP2APEL

**WELDING SET WITH ADAPTERS 16-63 mm**

	W		⚖️	KOD
			kg/pc	
RSP 2a	800	matrice Ø 16 – 63	9,223	SVAKRSP2A6E
RSP 2aPm	800	matrice Ø 16 – 63	8,645	SVAKRSP2P6E

Includes pipe cutter PROFI, allen key, meter, stabilization jack, foot stand, adapters and welding machine according to the order.

**WELDING SET WITH ADAPTERS 20-32 mm**

	W		⚖️	KOD
			kg/pc	
RSP 2a	800	matrice Ø 20 – 32	4,545	SVAKRSP2A3E
RSP 2aPm	800	matrice Ø 20 – 32	4,490	SVAKRSP2P3E

Includes pipe cutter STANDARD, allen key, stabilization jack, stabilisation foot stand, adapters and welding machine according to the order.

# Accessories (IV.)



## REPAIRING SET

	📦	⚖️	KOD
		kg/pc	
komplet	1	0,186	OSAXXXXXXX

Repairing set includes 5 pcs of repairing stakes  $\varnothing$  12 mm and non-paired adapter  $\varnothing$  12 mm.



## REPAIRING STAKES

$\varnothing$ mm	📦	⚖️	KOD
		kg/pc	
12	1 (5)	0,029	OTXXXXXXX



## ELECTROFUSION WELDING MACHINE

	W	📦	⚖️	KOD
			kg/pc	
S 315	max. 2470	1	8,000	SVAEUNI315

job-order manufacture, delivery date 30 days

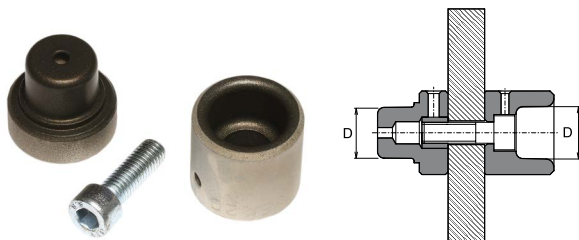

## ADAPTER PAIRED

D mm	📦	⚖️	KOD
		kg/pc	
16	1	0,074	NAP016XXXX
20	1	0,078	NAP020XXXX
25	1	0,138	NAP025XXXX
32	1	0,164	NAP032XXXX
40	1	0,308	NAP040XXXX
50	1	0,333	NAP050XXXX
63	1	0,493	NAP063XXXX
75	1	0,653	NAP075XXXX
90	1	1,089	NAP090XXXX
110	1	1,681	NAP110XXXX
125	1	1,996	NAP125XXXX

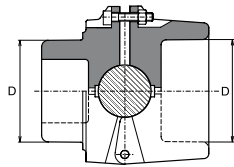
**ADAPTER NON-PAIRED**

D mm	📦	⚖️ kg/pc	KOD
16	1	0,130	NA016CXXXX
20	1	0,133	NA020CXXXX
25	1	0,178	NA025CXXXX
32	1	0,215	NA032CXXXX
40	1	0,379	NA040CXXXX
50	1	0,517	NA050CXXXX
63	1	0,822	NA063CXXXX

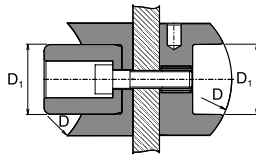
**ADAPTER FOR WELD IN SADDLE / PAIRED**

D mm	D <sub>1</sub> mm	📦	⚖️ kg/pc	KOD
63	32	1	0,298	SNNS06332X
75	32	1	0,296	SNNS07532X
90	32	1	0,296	SNNS09032X
⊕ 110	40	1	0,432	SNNS11040X

⊕ for weld in saddle with diameter 110/32 and 110/40

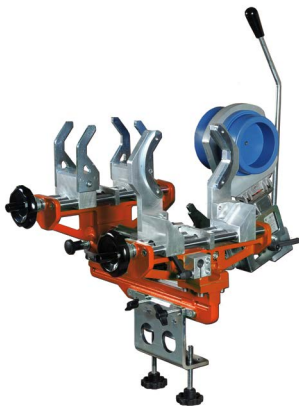
**ASSEMBLY JIG MP-125**

	D mm	📦	⚖️ kg/pc	KOD
MP-125	63-125	1	37,200	SVAMP125XX

MP 125 Includes frame, stand with welding machine with power consumption of 1400 W, case with accessories.

job-order manufacture, delivery date 30 days

**CONTACT THERMOMETER „DT” METER**

	📦	⚖️ kg/pc	KOD
DT-METER	1	0,940	TEPODXXXXX

# Accessories (IV.)



## TIGHTENING SPANNER WITH BAND

	📦	⚖️	KOD
	1	kg/pc 0,297	UKXXXXXXXXX



## PIPE CUTTER - SHEAR (PROFI)

	D mm	📦	⚖️ kg/pc	KOD
PROFI	16-40	1	0,383	NU042PXXXX



## PIPE CUTTER - SHEAR (PROFI M2)

	D mm	📦	⚖️ kg/pc	KOD
M2	16-63	1	1,241	NU063XXXXX



## PIPE CUTTER - SHEAR (STANDARD)

	D mm	📦	⚖️ kg/pc	KOD
STANDARD	16-40	1	0,360	NU042HSXXX



## PIPE CUTTER

	D mm	📦	⚖️ kg/pc	KOD
	50-140	1	1,420	REZ050140X

**STABI PIPE SHAVER**

D <sub>1</sub> mm	📦	⚖️ kg/pc	KOD
16-20	1	0,134	REZS01620X
20-25	1	0,156	REZS02025X
25-32	1	0,206	REZS02532X
32-40	1	0,266	REZS03240X
50	1	0,302	REZS050XXX
63	1	0,352	REZS063XXX
75	1	0,386	REZS075XXX
90	1	0,634	REZS090XXX
110	1	0,870	REZS110XXX

**SHAVERS TO DRILL MACHINE FOR STABI PIPES**

D mm	📦	⚖️ kg/pc	KOD
16	1	0,096	REZS016VXX
20	1	0,076	REZS020VXX
25	1	0,144	REZS025VXX
32	1	0,242	REZS032VXX
40	1	0,290	REZS040VXX
50	1	0,882	REZS050VXX
63	1	0,406	REZS063VXX
pintle	1	0,020	CEPXXXXXXX

**DRILL FOR WELD IN SADDLE**

D mm	📦	⚖️ kg/pc	KOD
32	1	0,200	VNS032XXXX
40	1	0,300	VNS040XXXX

**GALVANIZED TROUGH**

D mm	I mm	📦 I.	📦 II.	⚖️ kg/pc	KOD
20	2000	1	25	0,331	ZLSP20XXXX
25	2000	1	25	0,428	ZLSP25XXXX
32	2000	1	25	0,516	ZLSP32XXXX
40	2000	1	25	0,607	ZLSP40XXXX
50	2000	1	25	0,732	ZLSP50XXXX
63	2000	1	25	0,879	ZLSP63XXXX

# Accessories (IV.)



## PLUG - SHORT

G				KOD
	I.	II.	kg/pc	
1/2"	50	250	0,008	ZAGXXXXXX

including rubber seal



## PLUG - LONG

G				KOD
	I.	II.	kg/pc	
1/2"	50	250	0,022	ZAGDXXXXXX

including rubber seal



## MASTIC SEALANT - SISEAL

gr			KOD
		kg/pc	
10	1	0,018	TMSIS10XXX
100	1	0,124	TMSIS100XX

## SEALING TEFLON FIBRE



m			KOD
		kg/pc	
50	1	0,298	TTN50XXXXX
100	1	0,296	TTN150XXXX



- ② For production and testing is used standard EN ISO 15874. Requirements from this standard are stated in PN 01 (Internal Company Standard).
- ② The application and assembling of products have to conform to assembly regulations of ekoplastik system.
- ② System of quality is certified in accordance with ISO 9001-2000
- ② Extended warranty period 10 years for standard products (I.,II.)
- ② Common warranty period 2 years for other products (III.,IV.)

**SHORTCUTS USED**

CODE – purchasing code

S/PN – serie / pressure line

I. – small packing

II. – big packing

G – female cylindrical thread no sealing on threads

Rp – female cylindrical thread sealing on threads

R – male conical thread sealing on threads

# Designation of pipes S (SDR) instead of PN

Designation of pipes S (SDR) instead of PN In accordance with the ČSN EN ISO15874 and DIN 8077 standards, it is necessary to designate the pipes as „S“ or „SDR“ instead of „PN“.

$$\text{SDR} = 2S + 1$$

$$\text{SDR} \approx D/t$$

Legend:

D = outside diameter

t = the wall thickness

- ⦿ The „PN“ designation indicates the permissible operating pressure in bar for maximum temperature 20 °C and service life of 50 years
- ⦿ For the lowest design coefficient according to „PN“, the standards ČSN EN ISO 15874 and DIN 8077 no longer specify the pipe classification.
- ⦿ We designate the PPR tubes as „PN“ for historical reasons (it used to be the former designation for the pressurised product range) although the values no longer correspond to the definition above.
- ⦿ The PP-RCT is a new type of material and the „PN“ designation has not been implemented.
- ⦿ The operating parameters of the pipes are specified in the designation on the tubes and in the Assembly instructions.

**The catalogue states the „PN“ values for the pipes made of PP-RCT for easier orientation (the „PN“ formula as specified in the standard was used in the calculation).**







## Major areas of application of individual pipe

	PPR PN10 Ø 20-125 mm	PPR PN16 Ø 16-125 mm	PPR PN20 Ø 16-125 mm	EVO Ø 16-125 mm	FIBER BASALT CLIMA Ø 20-125 mm	STABI PLUS Ø 16-110 mm	FIBER BASALT PLUS Ø 20-125 mm
	●	●	●	●	●	●	●
		●	●	●	●	●	●
max. 70 °C			●	●		●	●
max. 90 °C						●	●

# Notes

A large grid area for taking notes, consisting of a 20x30 grid of small squares. The grid is light blue and occupies most of the page below the 'Notes' header.



**EKOPLASTIK®**

**CONNECT TO BETTER**

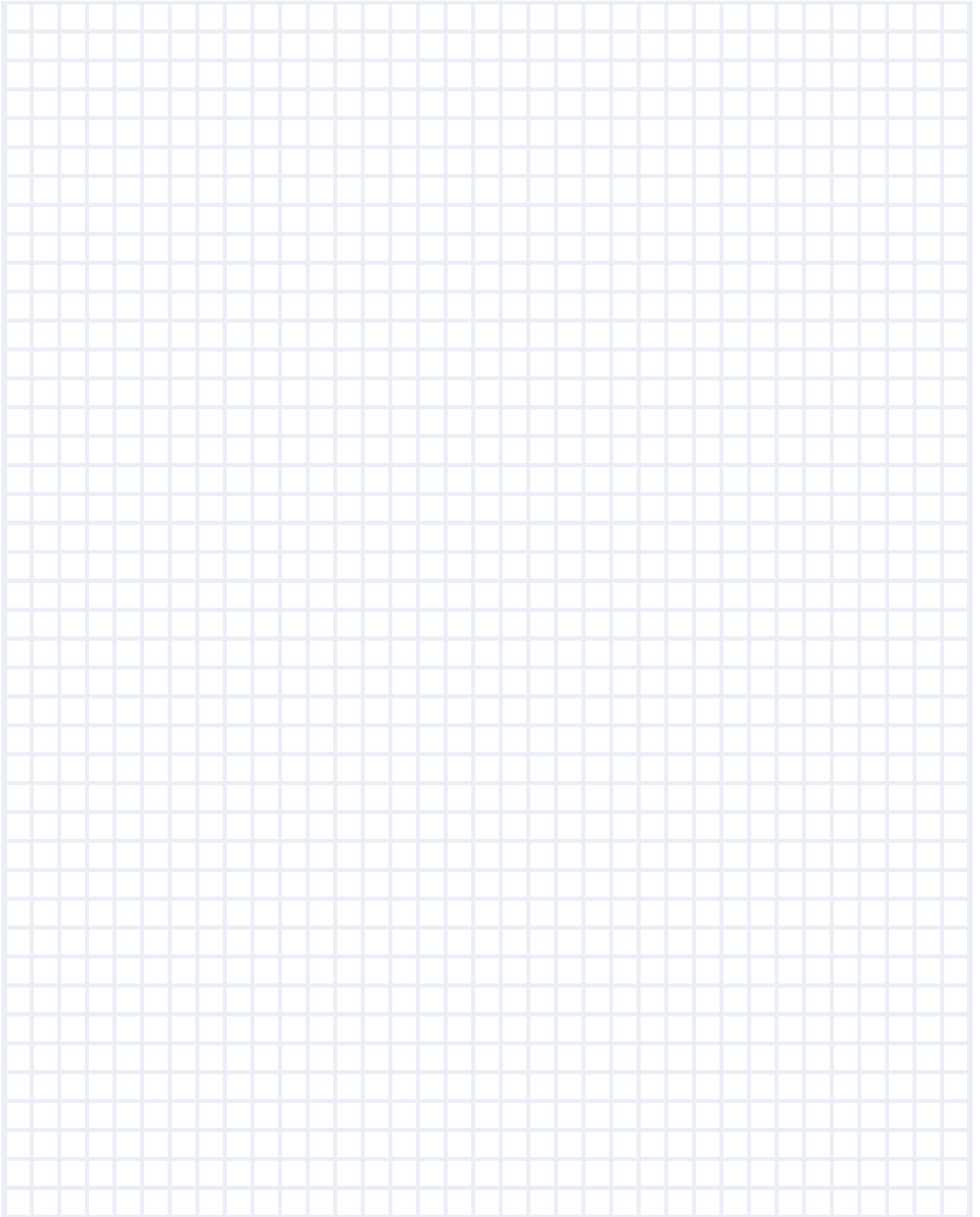

Discover our broad portfolio at  
**[www.wavinoverseas.com](http://www.wavinoverseas.com)**  
**[www.wavin.ae](http://www.wavin.ae)**  
**[www.wavin.asia](http://www.wavin.asia)**

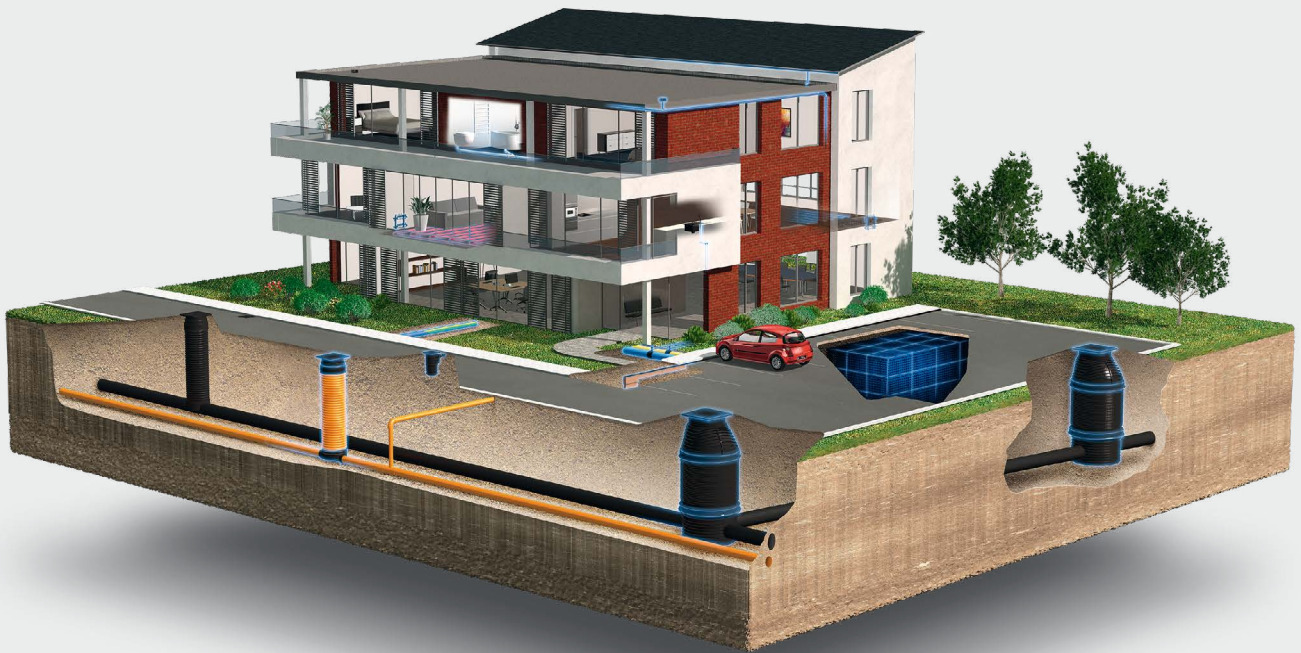

Water management | Heating and cooling | Water and gas distribution  
Waste water drainage | Cable ducting

- › [www.wavinoverseas.com](http://www.wavinoverseas.com) or
- › [www.wavin.ae](http://www.wavin.ae) Middle East & North Africa
- › [www.wavin.asia](http://www.wavin.asia) for Asia Pacific

Wavin operates a programme of continuous product development, and therefore reserves the right to modify or amend the specification of their products without notice. All information in this publication is given in good faith, and believed to be correct at the time of going to press. However, no responsibility can be accepted for any errors, omissions or incorrect assumptions. Users should satisfy themselves that products are suitable for the purpose and application intended.



**wavin**

**EKOPLASTIK®**

CONNECT TO BETTER