

Distribusi air
Panas dan Dingin

Wavin PPR Ekoplastik

Katalog Produk

wavin

Wavin PPR Ekoplastik

Isi

Varian Produk.....	3
Sistem Ekoplastik - Keunggulan, Penyebutan pipa S (SDR) daripada PN.....	5
Standar Produk untuk air minum (dingin) dan air panas serta pemanas (I.).....	6
Standar Produk khusus untuk air minum (dingin) (II.)	27
Produk untuk Pemakaian sementara (non Standard) (III.).....	27
Aksesoris (IV.)	27

Informasi Dasar Varian Produk

Area Pemasangan Utama pada Tiap Pipa



Ekoplastik PPR PN10
Ø 20-125 mm

Ekoplastik PPR PN16
Ø 16-125 mm

Ekoplastik PPR PN20
Ø 16-125 mm

Ekoplastik Evo / Evo Plus
Ø 16-125 mm

Ekoplastik Stabi Plus
Ø 16-110 mm

Ekoplastik Fiber Basalt Plus
Ø 20-125 mm

Ekoplastik Fiber Basalt Clima
Ø 20-125 mm



max. 70 °C



max. 90 °C

Multilayer pipes made from PP-RCT

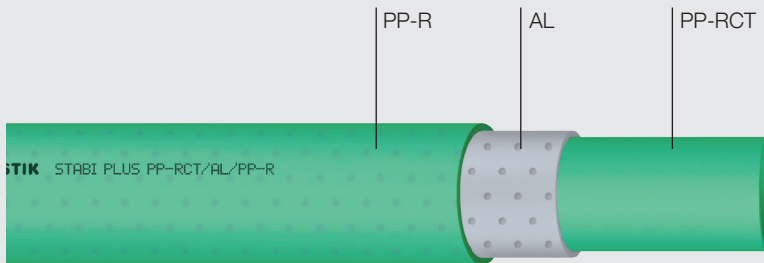

Ekoplastik Stabi Plus

- ⦿ 3× lesser thermal expansion
- ⦿ oxygen barrier
- ⦿ heating

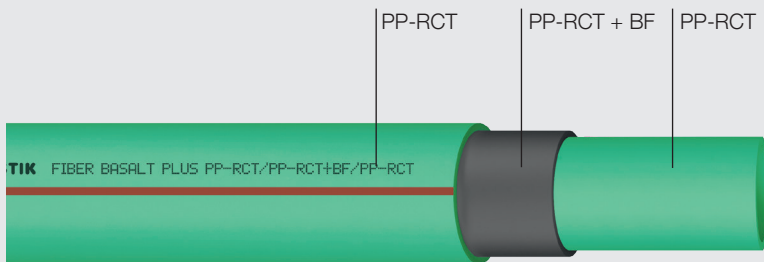

Ekoplastik Fiber Basalt Plus

- ⦿ 3× lesser thermal expansion
- ⦿ no need to shave before welding
- ⦿ hot water, heating

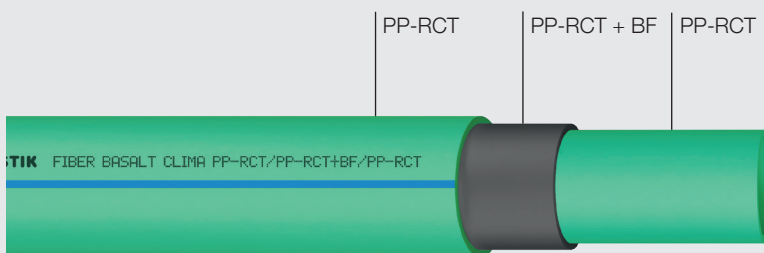

Ekoplastik Fiber Basalt Klima

- ⦿ 3× lesser thermal expansion
- ⦿ no need to shave before welding
- ⦿ cold water, air conditioning

Wavin PPR Ekoplastik

Sistem Ekoplastik adalah sistem pipa plastik yang digunakan untuk distribusi air panas dan dingin dalam bangunan, lantai dan pemanas atau pendingin ruangan central.

Keunggulan

- ⦿ Sistem pipa PP berkualitas tinggi dari Wavin
- ⦿ Termasuk PP-RCT material terbaru generasi ke 4
- ⦿ Termasuk pipa 3 lapis yang unik dengan penguat *basalt fiber*
- ⦿ Pipa 4 lapis terbaru dengan *basalt fiber* dan penahan oksigen
- ⦿ Tahan terhadap tekanan dan temperature tinggi

Penyebutan Pipa S (SDR) daripada PN

Penggunaan nama pipa S (SDR) sebagai pengganti PN sesuai dengan standard ČSN EN ISO15874 dan DIN 8077, penyebutan pipa perlu diganti sebagai „S“ atau „SDR“ bukan „PN“.

$$\text{SDR} = 2S+1$$

$$\text{SDR} \approx D/t$$

Legend:

D = outside diameter
t = ketebalan dinding

- ⦿ Kami menyebut pipa PPR sebagai „PN“ karena alasan historis (dimana penyebutan itu digunakan untuk varian produk bertekanan) meskipun nilainya kini sudah tidak lagi sesuai dengan penjelasan diatas.
- ⦿ PP-RCT adalah material tipe baru dan penamaan „PN“ belum diimplementasikan.
- ⦿ Parameter penggunaan pipa disebutkan dalam penamaan tabung dan dalam instruksi pemasangan.
- ⦿ Pemakaian nama „PN“ digunakan untuk menunjukkan tekanan operasi permisif dalam bar untuk temperature maksimal 20 °C dan masa pemakaian 50 tahun.
- ⦿ Untuk koefisien desain terendah pada penamaan „PN“, dalam standar ČSN EN ISO 15874 dan DIN 8077 tidak lagi disebutkan klasifikasi pipanya.

Katalog menyebutkan nilai „PN“ pada pipa PP-RCT untuk kemudahan orientasi (formula „PN“ seperti yang disebutkan dalam standar digunakan dalam perhitungan).

Katalog Produk

Produk Standar untuk Air Minum (dingin) dan Air Panas serta Pemanas (I.)

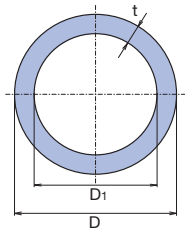
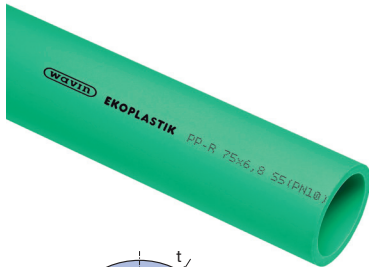

Pipa Ekoplastik S 5 / PN 10 / SDR 11

D mm	D ₁ mm	t mm	l mm	⊞ m	kg/m	KODE
20	15,6	2,2	4000	100	0,121	TTR020P10X
25	20,4	2,3	4000	60	0,164	TTR025P10X
32	26,2	2,9	4000	40	0,258	TTR032P10X
40	32,6	3,7	4000	24	0,413	TTR040P10X
50	40,8	4,6	4000	16	0,636	TTR050P10X
63	51,4	5,8	4000	12	1,004	TTR063P10X
75	61,4	6,8	4000	8	1,401	TTR075P10X
90	73,6	8,2	4000	4	2,014	TTR090P10X
110	90,0	10,0	4000	4	3,009	TTR110P10X
⊙ 125	102,2	11,4	4000	4	3,910	TTR125P10X

⊙ job-order manufacture, delivery date 30 days

Pipa Ekoplastik S 3,2 / PN 16 / SDR 7,4

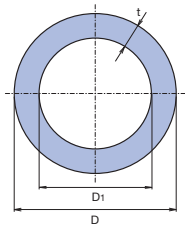
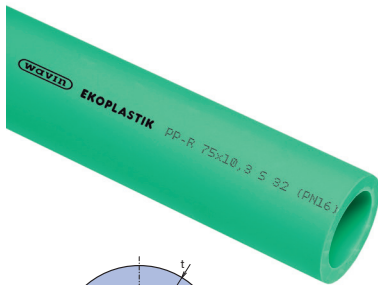

D mm	D ₁ mm	t mm	l mm	⊞ m	kg/m	KODE
16	11,6	2,2	4000	160	0,094	TTR016P16X
20	14,4	2,8	4000	100	0,145	TTR020P16X
25	18,0	3,5	4000	60	0,227	TTR025P16X
32	23,2	4,4	4000	40	0,367	TTR032P16X
40	29,0	5,5	4000	24	0,566	TTR040P16X
50	36,2	6,9	4000	16	0,886	TTR050P16X
63	45,8	8,6	4000	12	1,387	TTR063P16X
75	54,4	10,3	4000	8	1,990	TTR075P16X
90	65,4	12,3	4000	4	2,839	TTR090P16X
110	79,8	15,1	4000	4	4,274	TTR110P16X
⊙ 125	90,8	17,1	4000	4	5,530	TTR125P16X

⊙ job-order manufacture, delivery date 30 days

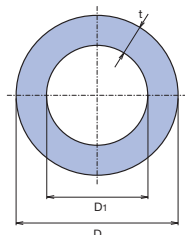

Pipa Ekoplastik S 2,5 / PN 20 / SDR 6

D mm	D ₁ mm	t mm	l mm	⊞ m	kg/m	KODE
16	10,6	2,7	4000	160	0,107	TTR016P20X
20	13,2	3,4	4000	100	0,169	TTR020P20X
25	16,6	4,2	4000	60	0,259	TTR025P20X
32	21,2	5,4	4000	40	0,423	TTR032P20X
40	26,6	6,7	4000	24	0,657	TTR040P20X
50	33,4	8,3	4000	16	1,013	TTR050P20X
63	42,0	10,5	4000	12	1,611	TTR063P20X

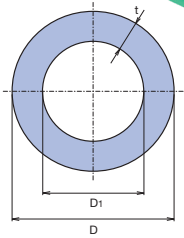
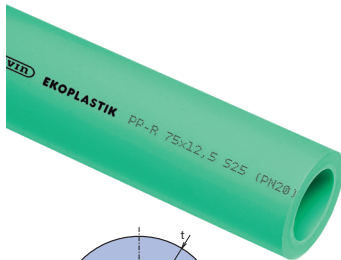

Pipa Ekoplastik S 2,5 / PN 20 / SDR 6 – 3 m

D mm	D ₁ mm	t mm	l mm	⊞ m	⚖ kg/m	KODE
20	13,2	3,4	3000	75	0,169	TTR020P203
25	16,6	4,2	3000	45	0,259	TTR025P203
32	21,2	5,4	3000	30	0,423	TTR032P203

Semua pipa diatas dapat dibuat dengan panjang alternatif sebagai pesanan khusus melalui perjanjian sebelumnya.

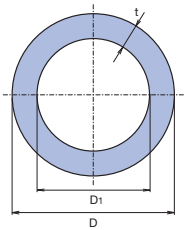

Pipa Ekoplastik Evo 16 mm S 3,2 / SDR 7,4 / PN 28 (calculation) Pipa Ekoplastik Evo Plus 20-25 mm S 3,2 / SDR 7,4 / PN 28 (calculation) Pipa Ekoplastik Evo 32-125 mm S 4 / SDR 9 / PN 22 (calculation)

D mm	D ₁ mm	t mm	l mm	⊞ m	⚖ kg/m	KODE
16	11,6	2,2	4000	160	0,095	TTRE016S32
20	14,4	2,8	4000	100	0,161	TTRE020S32
25	18,0	3,5	4000	60	0,191	TTRE025S32
32	24,8	3,6	4000	40	0,313	TTRE032S4
40	31,0	4,5	4000	24	0,487	TTRE040S4
50	38,8	5,6	4000	16	0,755	TTRE050S4
63	48,8	7,1	4000	12	1,200	TTRE063S4
75	58,2	8,4	4000	8	1,690	TTRE075S4
90	69,8	10,1	4000	4	2,440	TTRE090S4
110	85,4	12,3	4000	4	3,620	TTRE110S4
125	97,0	14,0	4000	4	4,660	TTRE125S4

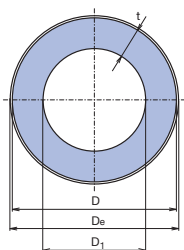

Pipa Ekoplastik Stabi Plus 16-63mm S 3,2 / SDR 7,4 / PN 28 (calculation) Pipa Ekoplastik Stabi Plus 75-110 mm S 4 / SDR 9 / PN 22 (calculation)

D mm	D ₁ mm	D _e mm	t mm	l mm	⊞ m	⚖ kg/m	KODE
16	11,4	17,9	2,2	4000	120	0,137	TTRS016RCT
20	14,4	21,9	2,8	4000	80	0,207	TTRS020RCT
25	18,0	26,9	3,5	4000	60	0,298	TTRS025RCT
32	23,2	33,9	4,4	4000	40	0,465	TTRS032RCT
40	29,0	41,9	5,5	4000	20	0,692	TTRS040RCT
50	36,2	52,0	6,9	4000	16	1,046	TTRS050RCT
63	45,8	65,0	8,6	4000	8	1,587	TTRS063RCT
75	58,2	77,0	8,4	4000	8	1,860	TTRS075RCT
90	69,8	92,0	10,1	4000	4	2,673	TTRS090RCT
110	85,4	112,0	12,3	4000	4	4,022	TTRS110RCT

Ø 16 - 110 with perforated aluminum foil

Katalog Produk

Produk Standar untuk Air Minum (dingin) dan Air Panas serta Pemanas (I.)

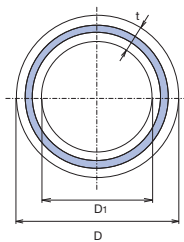
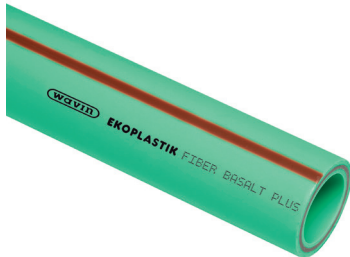

Pipa Ekoplastik Fiber Basalt Plus 20-63 mm S 3,2 / SDR 7,4 / PN 28 (calculation)
Pipa Ekoplastik Fiber Basalt Plus 75-125 mm S 4 / SDR 9 / PN 22 (calculation)

D mm	D ₁ mm	t mm	l mm	⊞ m	kg/m	KODE
20	14,4	2,8	4000	100	0,153	TTRFB020TRCT
25	18,0	3,5	4000	60	0,239	TTRFB025TRCT
32	23,2	4,4	4000	40	0,385	TTRFB032TRCT
40	29,0	5,5	4000	24	0,599	TTRFB040TRCT
50	36,2	6,9	4000	16	0,941	TTRFB050TRCT
63	45,8	8,6	4000	12	1,471	TTRFB063TRCT
75	58,2	8,4	4000	8	1,764	TTRFB075TRCT
90	69,8	10,1	4000	4	2,546	TTRFB090TRCT
110	85,4	12,3	4000	4	3,781	TTRFB110TRCT
⊞ 125	97,0	14,0	4000	4	4,891	TTRFB125TRCT

⊞ job-order manufacture, delivery date 30 days

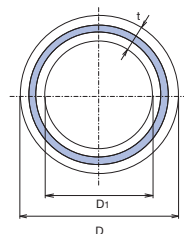

Pipa Ekoplastik Fiber Basalt Clima 20-25 mm S 4 / SDR 9 / PN 22 (calculation)
Pipa Ekoplastik Fiber Basalt Clima 32-125 mm S 5 / SDR 11 / PN 18 (calculation)

D mm	D ₁ mm	t mm	l mm	⊞ m	kg/m	KODE
20	15,4	2,3	4000	100	0,128	TTRFBC020TRCT
25	19,4	2,8	4000	60	0,199	TTRFBC025TRCT
32	26,2	2,9	4000	40	0,269	TTRFBC032TRCT
40	32,6	3,7	4000	24	0,428	TTRFBC040TRCT
50	40,8	4,6	4000	16	0,664	TTRFBC050TRCT
63	51,4	5,8	4000	12	1,050	TTRFBC063TRCT
⊞ 75	61,4	6,8	4000	8	1,501	TTRFBC075TRCT
⊞ 90	73,6	8,2	4000	4	2,122	TTRFBC090TRCT
⊞ 110	90,0	10,0	4000	4	3,160	TTRFBC110TRCT
⊞ 125	102,2	11,4	4000	4	4,082	TTRFBC125TRCT

⊞ job-order manufacture, delivery date 30 days

Pipe in Coil



D mm	S mm	SDR mm	t mm	l m	☒	kg/m	KODE 100 m	KODE 200 m
16	3,2 (16)	7,4	2,2	100	1	0,094	TTRK016P17	
20	5,0 (10)	11	2,2	100/200	1	0,121	TTRK020P11	TTRK020P10
20	3,2 (16)	5,4	2,8	100/200	1	0,145	TTRK020P17	TTRK020P16
16	2,5 (20)	6	2,7	100/200	1	0,107	TTRK016P21	TTRK016P20
20	2,5 (20)	6	3,4	100/200	1	0,169	TTRK020P21	TTRK020P20

job-order manufacture, delivery date 30 days

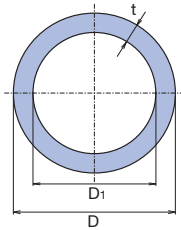

Katalog Produk

Standar untuk Air Minum (dingin) dan Air Panas serta Pemanas (I.)

Elbow 90 °

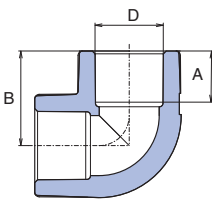

D mm	A mm	B mm	📦 I.	📦 II.	⚖️ kg/pc	KODE
16	13,0	23,2	50	250	0,010	TKO01690XX
20	14,5	26,8	50	500	0,018	TKO02090XX
25	16,0	31,0	50	250	0,030	TKO02590XX
32	18,0	36,5	25	150	0,056	TKO03290XX
40	20,5	43,0	10	70	0,066	TKO04090RCT
50	23,5	51,0	10	40	0,125	TKO05090RCT
63	27,5	60,0	5	15	0,240	TKO06390RCT
75	30,0	70,1	2	6	0,558	TKO07590RCT
90	33,0	82,0	1	5	1,010	TKO09090RCT
110	37,0	95,0	1	1	1,344	TKO11090RCT
125	40,0	105,0	1	1	1,640	TKO12590RCT

🕒 Information about delivery on request

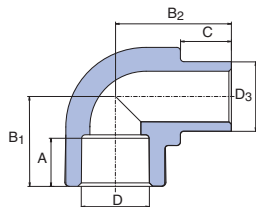

Elbow 90 ° Internal / External

D, D3 mm	A mm	B1 mm	B2 mm	C mm	📦 I.	📦 II.	⚖️ kg/pc	KODE
20	14,5	26,8	30,3	13,0	50	250	0,014	TKO120XXXX
25	16,0	31,0	35,0	14,0	50	200	0,024	TKO125XXXX
32	18,0	36,5	42,2	16,0	25	100	0,044	TKO132XXXX

Elbow 45 °

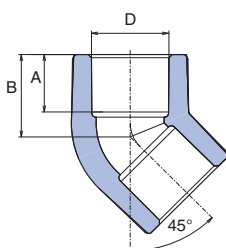

D mm	A mm	B mm	📦 I.	📦 II.	⚖️ kg/pc	KODE
16	13,0	18,7	50	50	0,008	TKO01645XX
20	14,5	20,8	100	500	0,014	TKO02045XX
25	16,0	24,0	50	250	0,024	TKO02545XX
32	18,0	27,0	20	80	0,042	TKO03245XX
40	20,5	31,5	5	25	0,052	TKO04045RCT
50	23,5	36,5	5	20	0,092	TKO05045RCT
63	27,5	43,0	5	10	0,188	TKO06345RCT
75	30,0	48,1	2	6	0,272	TKO07545RCT
90	33,0	54,1	1	6	0,654	TKO09045RCT
110	37,0	62,1	1	1	0,965	TKO11045RCT
125	40,0	69,8	1	3	1,048	TKO12545RCT

Elbow 45° Internal / External

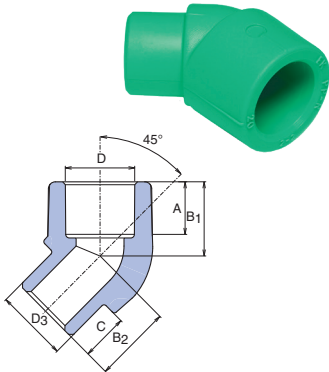

D mm	D ₃ mm	A mm	B ₁ mm	B ₂ mm	C mm	⊞ I.	⊞ II.	⚖ kg/pc	KODE
16	16	13,0	18,7	18,7	12,0	50	50	0,008	TKO11645XX
20	20	14,5	20,8	21,5	13,0	10	100	0,012	TKO12045XX
25	25	16,0	24,0	24,0	14,0	10	100	0,026	TKO12545XX

Tee

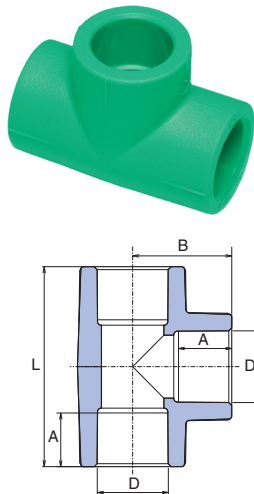

D mm	A mm	B mm	L mm	⊞ I.	⊞ II.	⚖ kg/pc	KODE
16	13,0	23,2	46,4	50	50	0,012	TTK016XXXX
20	14,5	27,0	54,0	50	300	0,022	TTK020XXXX
25	16,0	32,0	60,0	50	200	0,038	TTK025XXXX
32	18,0	35,7	70,0	20	100	0,070	TTK032XXXX
40	20,5	38,5	86,2	10	50	0,124	TTK040RCTX
50	23,5	51,0	102,0	5	30	0,196	TTK050RCTX
63	27,5	61,5	123,0	5	15	0,430	TTK063RCTX
75	30,0	70,1	140,2	1	5	0,644	TTK075RCTX
90	33,0	83,1	166,2	1	1	1,134	TTK090RCTX
110	37,0	99,1	198,2	1	1	1,962	TTK110RCTX
⊕ 125	40,0	105,0	210,0	1	1	2,030	TTK125RCTX

⊕ Information about delivery on request

Reducing Tee

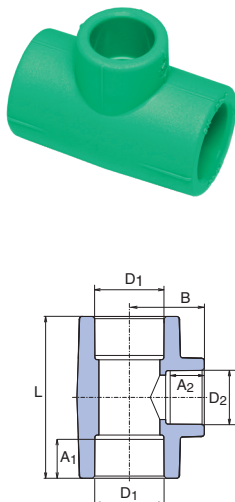

D ₁ mm	D ₂ mm	A ₁ mm	A ₂ mm	L mm	B mm	⊞ I.	⊞ II.	⚖ kg/pc	KODE
20	16	14,5	13,0	53,0	23,0	50	50	0,018	TTKR02016X
25	20	16,0	14,5	55,0	29,0	50	200	0,032	TTKR02520X
32	20	18,0	14,5	67,0	34,4	50	150	0,052	TTKR03220X
32	25	18,0	16,0	73,0	34,4	25	100	0,062	TTKR03225X
40	20	20,5	14,5	66,0	37,0	20	60	0,056	TTKR04020RCT
40	25	20,5	16,0	71,0	38,5	10	50	0,062	TTKR04025RCT
40	32	20,5	18,0	78,0	41,5	10	40	0,071	TTKR04032RCT
50	25	23,5	16,0	77,0	43,0	5	15	0,104	TTKR05025RCT
50	32	23,5	18,0	84,0	46,0	5	30	0,136	TTKR05032RCT
50	40	23,5	20,5	92,0	48,0	5	15	0,132	TTKR05040RCT
63	25	27,5	16,0	85,0	49,9	5	10	0,167	TTKR06325RCT
63	32	27,5	18,0	92,0	52,0	5	15	0,195	TTKR06332RCT
63	40	27,5	20,5	100,0	54,6	5	15	0,230	TTKR06340RCT
63	50	27,5	23,5	110,0	57,2	5	15	0,360	TTKR06350RCT
75	40	30,0	20,5	115,4	63,5	1	15	0,360	TTKR07540RCT
90	75	33,0	30,0	146,2	77,7	1	15	0,605	TTKR09075RCT

Katalog Produk

Standar untuk Air Minum (dingin) dan Air Panas serta Pemanas (I.)

Reducing Tee

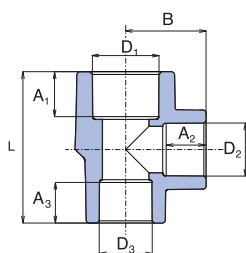

D1 mm	D2 mm	D3 mm	A1 mm	A2 mm	A3 mm	L mm	B mm	⊕ I.	⊕ II.	kg/pc	KODE
25	20	20	16,0	14,5	14,5	55,2	29,3	10	50	0,028	TTKR0252020
32	20	20	18,0	14,5	14,5	57,3	32,8	10	50	0,040	TTKR0322020
32	20	25	18,0	14,5	16,0	58,9	32,8	10	50	0,044	TTKR0322520
32	25	25	18,0	18,0	16,0	66,0	34,4	10	50	0,052	TTKR0322525

Cross Piece

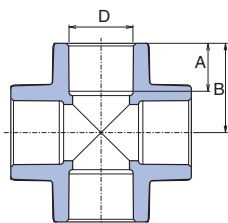

D3 mm	A mm	B1 mm	⊕ I.	⊕ II.	kg/pc	KODE
20	14,5	26,3	25	25	0,024	TKRI020XXX
25	16,0	30,1	25	25	0,042	TKRI025XXX
32	18,0	35,0	10	40	0,070	TKRI032XXX
40	20,5	42,0	10	30	0,128	TKRI040XXX

Bend

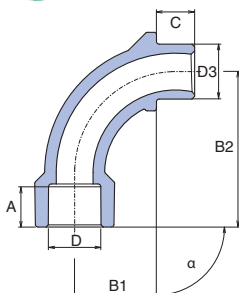

D mm	D3 mm	A mm	B1 mm	B2 mm	C mm	α	⊕ I.	⊕ II.	kg/pc	KODE
20	20	14,5	37,0	56,0	13,6	90°	25	100	0,022	TO02090XXX
25	25	16,0	45,0	67,0	14,6	90°	10	100	0,036	TO02590XXX

Three-Way Elbow

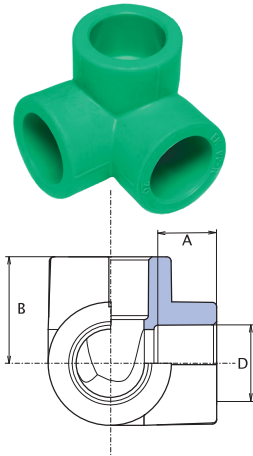

D mm	A mm	B mm	☒ I.	☒ II.	⚖️ kg/pc	KODE
20	14,5	26,8	10	50	0,020	TKOT020XXX
25	16,0	29,5	10	40	0,032	TKOT025XXX
32	18,0	35,0	5	20	0,062	TKOT032XXX
40	20,5	41,5	5	15	0,108	TKOT040XXX

Socket

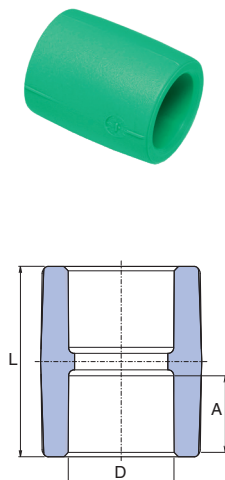

D mm	A mm	L mm	☒ I.	☒ II.	⚖️ kg/pc	KODE
16	13,0	33,0	50	50	0,006	TNA016XXXX
20	14,5	34,6	50	500	0,010	TNA020XXXX
25	16,0	37,8	50	250	0,018	TNA025XXXX
32	18,0	40,0	25	150	0,034	TNA032XXXX
40	20,5	48,0	20	80	0,041	TNA040RCTX
50	23,5	54,0	10	70	0,061	TNA050RCTX
63	27,5	63,0	5	30	0,127	TNA063RCTX
75	30,0	73,4	1	5	0,314	TNA075RCTX
90	33,0	79,2	1	1	0,470	TNA090RCTX
110	37,0	88,2	1	1	0,782	TNA110RCTX
☉ 125	40,0	86,0	1	1	0,745	TNA125RCTX

☉ Information about delivery on request

Reducer

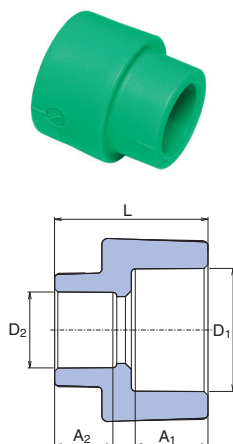

D1 mm	D2 mm	A1 mm	D2 mm	L mm	☒ I.	☒ II.	⚖️ kg/pc	KODE
25	20	16,0	14,5	34,0	50	450	0,014	TRE02520XX
32	20	18,0	14,5	39,0	50	250	0,026	TRE03220XX
32	25	18,0	16,0	39,5	50	250	0,028	TRE03225XX

Katalog Produk

Standar untuk Air Minum (dingin) dan Air Panas serta Pemanas (I.)

Reducer Internal / External

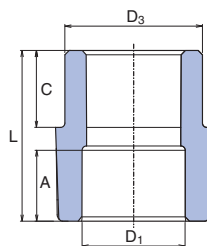

D ₃ mm	D ₁ mm	A mm	L mm	C mm	☐ I.	☐ II.	⚖️ kg/pc	KODE
20	16	13,0	32,5	13,0	50	50	0,006	TRE12016XX
25	20	14,5	34,0	14,0	50	500	0,010	TRE12520XX
32	20	14,5	40,0	16,0	50	200	0,016	TRE13220XX
32	25	16,0	39,5	16,0	50	300	0,018	TRE13225XX
40	20	14,5	36,3	18,5	10	50	0,021	TRE14020XX
40	25	16,0	38,3	18,5	10	50	0,022	TRE14025XX
40	32	18,0	41,3	18,5	20	60	0,023	TRE14032RCT
50	25	16,0	41,3	21,3	10	50	0,035	TRE15025RCT
50	32	18,0	43,3	22,0	10	50	0,035	TRE15032RCT
50	40	20,5	43,3	22,0	10	50	0,035	TRE15040RCT
63	25	16,0	45,3	25,3	5	10	0,060	TRE16325RCT
63	32	18,0	47,3	25,3	5	10	0,056	TRE16332RCT
63	40	20,5	44,3	25,3	5	10	0,058	TRE16340RCT
63	50	23,5	54,0	25,3	5	10	0,076	TRE16350RCT
75	40	20,5	64,5	28,9	5	20	0,116	TRE17540RCT
75	50	23,5	64,5	28,9	5	20	0,120	TRE17550RCT
75	63	27,5	71,5	28,9	1	5	0,210	TRE17563RCT
90	63	27,5	64,5	33,4	1	1	0,221	TRE19063RCT
90	75	30,0	78,0	33,4	1	1	0,290	TRE19075RCT
110	75	30,0	60,0	39,4	1	1	0,268	TRE111075RCT
110	90	33,0	87,0	39,4	1	1	0,502	TRE111090RCT
⊙125	110	40,0	100,3	42,4	1	1	0,678	TRE1125110RCT

⊙ Information about delivery on request

End Plug

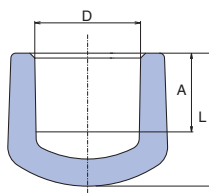

D mm	A mm	B mm	☐ I.	☐ II.	⚖️ kg/pc	KODE
16	13,5	20,9	50	50	0,004	TZA016XXXX
20	14,5	24,5	50	150	0,008	TZA020XXXX
25	16,0	28,0	50	150	0,014	TZA025XXXX
32	18,0	33,0	20	100	0,026	TZA032XXXX
40	20,5	34,0	5	25	0,032	TZA040XXXX
50	23,5	49,0	5	25	0,061	TZA050XXXX
63	27,5	46,5	5	25	0,105	TZA063XXXX
75	30,0	60,0	5	5	0,262	TZA075XXXE
90	33,0	69,0	1	1	0,425	TZA090XXXX
110	37,0	79,0	1	1	0,715	TZA110EXXX

End Plug Internal

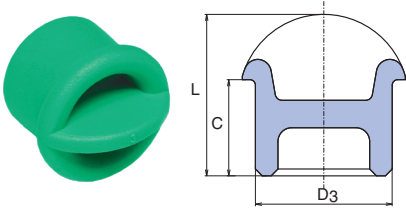

D ₃ mm	C mm	L mm	☒ I.	☒ II.	⚖ kg/pc	KODE
20,0	14,3	23,5	40	160	0,004	TZA120XXXE

Crossover S 2,5 / PN 20 / SDR 6

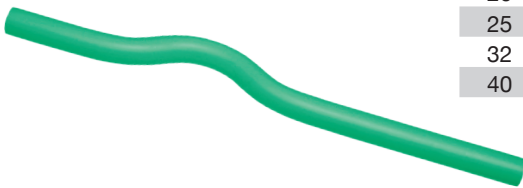
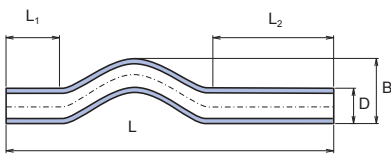

D ₃ mm	S (PN20)	B mm	L mm	L ₁ mm	L ₂ mm	☒ I.	☒ II.	⚖ kg/pc	KODE
16	2,5 (20)	35,0	400,0	80,0	180,0	10	10	0,044	TKR016P20X
20	2,5 (20)	47,0	400,0	80,0	180,0	10	50	0,070	TKR020P20X
25	2,5 (20)	52,0	400,0	80,0	120,0	10	50	0,110	TKR025P20X
32	2,5 (20)	65,0	390,0	64,0	106,0	5	20	0,174	TKR032P20X
40	2,5 (20)	65,0	390,0	64,0	106,0	5	20	0,268	TKR040P20X

Crossover with Socket

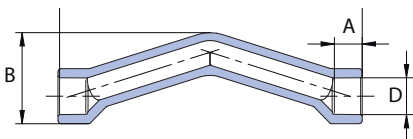

D mm	S (PN20)	A mm	B mm	L mm	☒ I.	☒ II.	⚖ kg/pc	KODE
20	2,5 (20)	14,5	33,4	160,0	10	50	0,041	TKRH020P20
25	2,5 (20)	16,0	44,2	200,0	10	50	0,089	TKRH025P20

Compensation Pipe S 2,5 / PN 20 / SDR 6

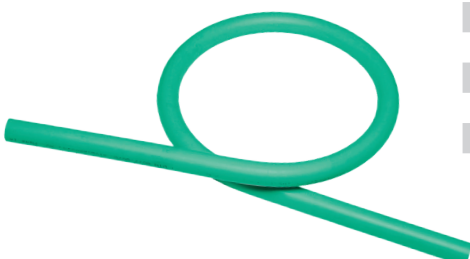
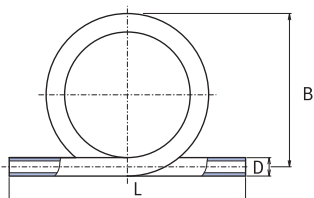

D mm	S (PN20)	B mm	L mm	☒ I.	⚖ kg/pc	KODE
16	2,5 (20)	185,0	320,0	10	0,090	TKS016P20X
20	2,5 (20)	200,0	450,0	10	0,174	TKS020P20X
25	2,5 (20)	210,0	440,0	10	0,264	TKS025P20X
32	2,5 (20)	230,0	410,0	5	0,430	TKS032P20X
40	2,5 (20)	290,0	450,0	3	0,786	TKS040P20X

Katalog Produk

Standar untuk Air Minum (dingin) dan Air Panas serta Pemanas (I.)

Reducing Sleeve with Metal Female Thread

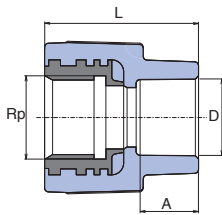

D mm	Rp mm	A mm	L mm	⊞ I.	⊞ II.	⚖ kg/pc	KODE
16	1/2"	13,0	38,0	10	50	0,050	TZI01620XX
20	1/2"	14,5	39,0	10	250	0,056	TZI02020XX
20	3/4"	14,5	42,0	10	100	0,072	TZI02025XX
25	1/2"	16,0	40,5	10	50	0,062	TZI02520XX
25	3/4"	16,0	47,0	10	100	0,075	TZI02525XX
32	3/4"	18,0	45,0	10	30	0,081	TZI03225EX
32	1"	18,0	57,0	10	60	0,148	TZI03232OK
40	5/4"	20,5	65,0	5	10	0,260	TZI04040XX
50	6/4"	23,5	69,0	4	4	0,328	TZI05050XX
63	2"	27,5	76,0	2	2	0,616	TZI06363XX
75	2½"	28,0	65,5	1	8	0,676	TZI07575RCT
90	3	32,0	90,0	1	6	0,954	TZI09090RCT

Reducing Sleeve with Metal Female Thread with Cross

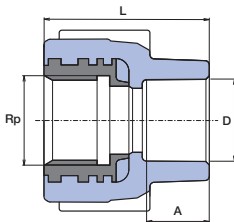

D mm	Rp mm	A mm	L mm	⊞ I.	⊞ II.	⚖ kg/pc	KODE
20	1/2"	14,5	42,0	10	100	0,058	TZI02020KX

Reducing Sleeve with Metal Male Thread

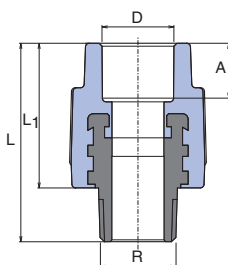

D mm	Rp mm	A mm	L mm	L ₁ mm	⊞ I.	⊞ II.	⚖ kg/pc	KODE
16	1/2"	13,0	52,0	37,5	10	50	0,064	TZE01620XX
20	1/2"	14,5	53,5	39,0	10	150	0,062	TZE02020XX
20	3/4"	14,5	58,0	40,0	10	100	0,096	TZE02025XX
25	1/2"	16,0	55,5	41,0	10	60	0,066	TZE02520XX
25	3/4"	16,0	59,0	41,0	20	100	0,098	TZE02525XX
32	3/4"	18,0	60,0	44,0	10	30	0,105	TZE03225XX
32	1"	18,0	62,5	46,0	10	60	0,170	TZE03232XX
32	1"	18,0	69,5	42,0	10	60	0,204	TZE03232OK
40	5/4"	20,5	80,0	48,0	5	10	0,312	TZE04040XX
50	6/4"	23,5	81,6	54,0	4	4	0,460	TZE05050XX
63	2"	27,5	101,0	63,5	2	2	0,758	TZE06363XX
75	2½"	30,0	110,0	69,7	1	1	1,150	TZE07575RCT
90	3"	33,0	130,0	85,0	1	1	1,774	TZE09090RCT

Metal Reducer with Cap Nut

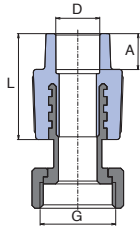
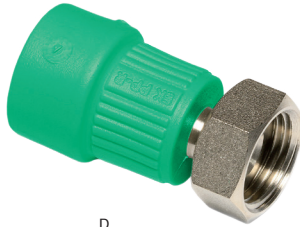

D mm	G	A mm	L mm	⊞ I.	⊞ II.	⚖ kg/pc	KODE
16	1/2"	13,0	32,0	10	10	0,044	TZM01620XX
16	3/4"	13,0	32,0	10	10	0,082	TZM01625XX
20	1/2"	14,5	40,0	20	100	0,048	TZM02020XX
20	3/4"	14,5	39,0	20	100	0,082	TZM02025XX
20	1"	14,5	39,0	5	10	0,152	TZM02032XX
25	3/4"	16,0	41,1	20	100	0,086	TZM02525XX
25	1"	16,0	41,0	4	4	0,154	TZM02532XX
32	5/4"	18,0	48,0	2	2	0,254	TZM03240XX
⊞ PMD							
20	3/4"	14,5	39,0	10	10	0,084	TZMD02025X

⊞ PMD – cap nut with the hole for the seal

Elbow 90° with Metal Female Thread

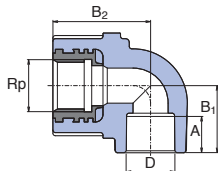

D mm	Rp mm	A mm	B ₁ mm	B ₂ mm	⊞ I.	⊞ II.	⚖ kg/pc	KODE
16	1/2"	13,0	25,2	31,0	10	50	0,062	TKOI01620X
20	1/2"	14,5	27,0	34,5	10	100	0,062	TKOI02020X
20	3/4"	14,5	27,0	40,0	10	50	0,082	TKOI02025X
25	1/2"	16,0	31,0	36,0	10	50	0,070	TKOI02520E
25	3/4"	16,0	30,0	41,0	10	100	0,090	TKOI02525X
32	1"	18,0	36,0	51,0	10	50	0,168	TKOI03232X

Elbow 90° with Metal Male Thread

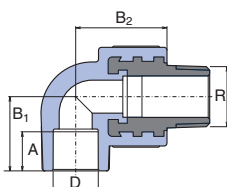

D mm	Rp mm	A mm	B ₁ mm	B ₂ mm	⊞ I.	⊞ II.	⚖ kg/pc	KODE
16	1/2"	13,0	25,2	31,0	10	50	0,074	TKOE01620X
20	1/2"	14,5	27,0	34,5	10	100	0,074	TKOE02020X
20	3/4"	14,5	27,0	39,0	10	50	0,112	TKOE02025X
25	1/2"	16,0	31,0	36,0	10	50	0,082	TKOE02520E
25	3/4"	16,0	30,0	39,0	10	80	0,116	TKOE02525X
32	1"	18,0	36,0	41,6	5	40	0,118	TKOE03232X

Katalog Produk

Standar untuk Air Minum (dingin) dan Air Panas serta Pemanas (I.)

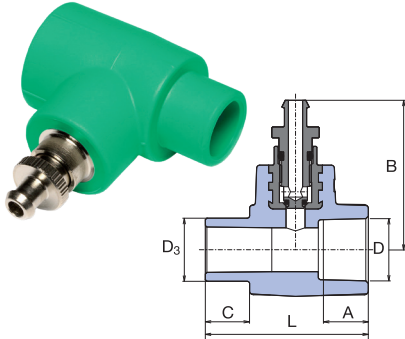

Socket with Drain Valve Internal / External

D mm	D ₃ mm	A mm	L mm	B mm	C mm	I.	II.	kg/pc	KODE
20	20	14,5	53,0	48,0	13,0	10	100	0,054	TNAVV120XX
25	25	16,0	54,0	49,7	14,0	5	150	0,064	TNAVV125XX
32	32	18,0	59,0	53,2	16,0	5	100	0,084	TNAVV132XX

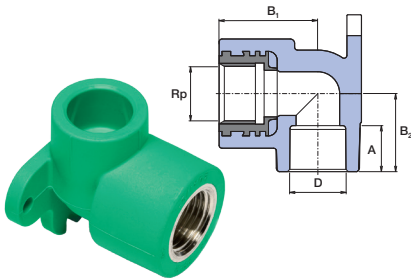

Elbow 90° for Wall Mounting

D mm	R _p	A mm	B ₁ mm	B ₂ mm	I.	II.	kg/pc	KODE
16	1/2"	13,0	32,0	23,2	10	60	0,064	TNK016XXXX
20	1/2"	14,5	34,0	26,8	10	150	0,068	TNK020XXXX
25	1/2"	16,0	36,0	27,5	10	50	0,072	TNK02520XX
25	3/4"	16,0	39,0	29,5	10	50	0,098	TNK025XXXX

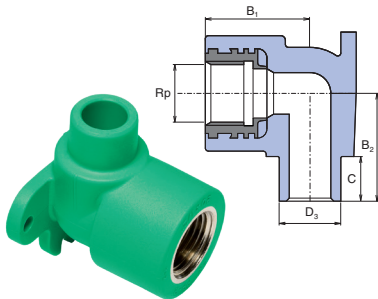

Elbow 90° for Wall Mounting Internal / External

D ₃ mm	R _p	B ₁ mm	B ₂ mm	C mm	I.	II.	kg/pc	KODE
20	1/2"	35,0	35,0	11,0	10	120	0,068	TNK120XXXX

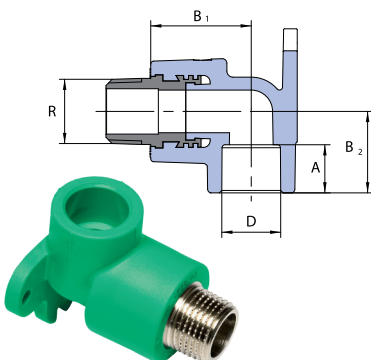

Elbow 90° for Wall Mounting with Metal Male Thread

D mm	R _p	B ₁ mm	B ₂ mm	A mm	I.	II.	kg/pc	KODE
20	1/2"	34,0	32,2	14,5	10	50	0,072	TNKE02020X

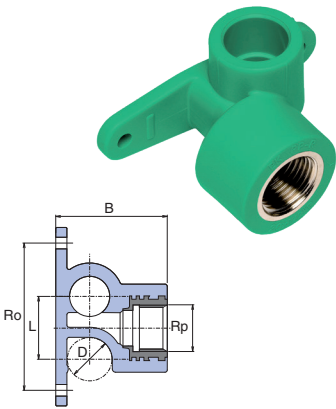

Ending Wall Elbow left

D mm	Rp	B mm	Ro mm	L mm	I.	II.	kg/pc	KODE
20	1/2"	50,0	66,0	28,5	5	25	0,066	TNK020KLXX

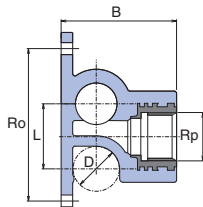

Ending Wall Elbow right

D mm	Rp	B mm	Ro mm	L mm	I.	II.	kg/pc	KODE
20	1/2"	50,0	66,0	28,5	5	25	0,066	TNK020KPXX

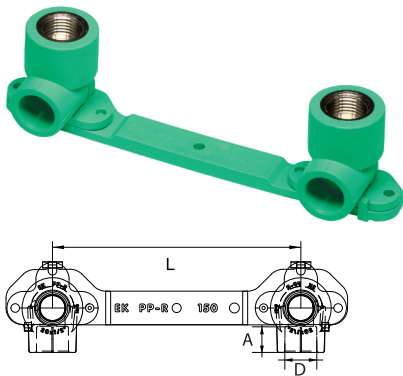
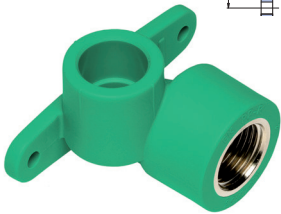

Wall Elbows with Holder

D mm	A mm	L mm	I.	II.	kg/pc	KODE
20	14,5	150	10	50	0,162	TNKD02020X

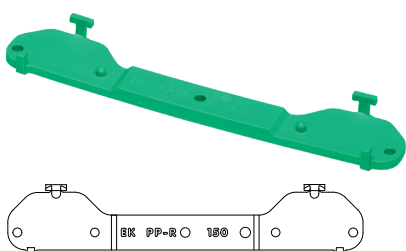

Holder for Wall Elbows

D mm	L mm	I.	II.	kg/pc	KODE
20	150	10	50	0,026	TDNKXXXXXX

Standar untuk Air Minum (dingin) dan Air Panas serta Pemanas (I.)

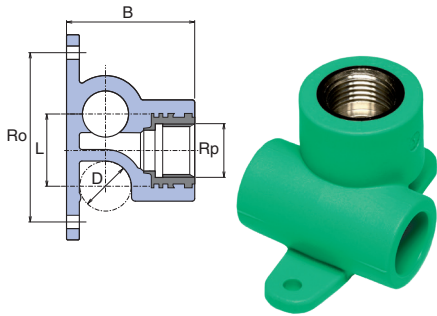

Tee with Tap Connector

D mm	Rp	B mm	Ro mm	L mm	I. mm	II. mm	kg/pc	KODE
20	1/2"	50,0	66,0	28,5	20	100	0,080	TNKP020XXX
25	1/2"	56,0	76,0	33,5	10	50	0,090	TNKP02520X

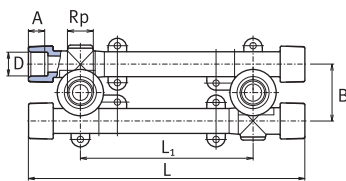

Wall Mounting Group with Tap Connectors

D mm	Rp	A mm	B mm	L1 mm	L mm	I. mm	II. mm	kg/pc	KODE
20	1/2"	14,5	46,0	105/130/145	229,0	1	10	0,220	TNKK020XXX
25	1/2"	16,0	51,0	110/125/140	230,0	1	10	0,268	TNKK025XXX

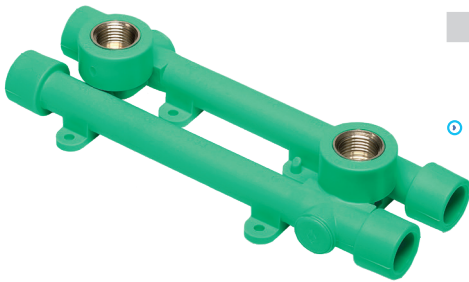

⊙ L1 - extension 100, 135, 150 mm, it is necessary to set right with eccentric parts.

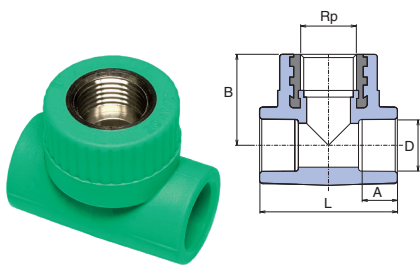

Tee with Metal Female Thread

D mm	Rp	A mm	L mm	B mm	I. mm	II. mm	kg/pc	KODE
20	1/2"	14,5	51,5	34,0	10	100	0,068	TTKI02020X
25	1/2"	16,0	80,0	40,0	10	100	0,076	TTKI02520X
25	3/4"	16,0	80,0	40,0	5	30	0,094	TTKI02525X
32	1/2"	18,0	71,0	40,5	5	25	0,106	TTKI03220X
32	3/4"	18,0	71,0	42,0	5	25	0,118	TTKI03225E
32	1"	18,0	80,0	55,0	5	20	0,186	TTKI03232X

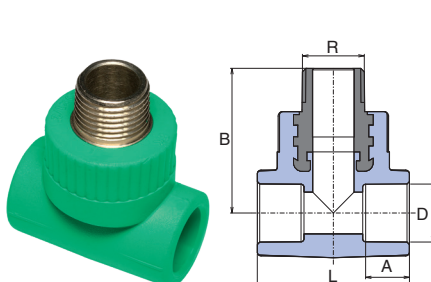

Tee with Metal Male Thread

D mm	Rp	A mm	L mm	B mm	I. mm	II. mm	kg/pc	KODE
20	1/2"	14,5	51,5	48,5	10	100	0,080	TTKE02020X
20	3/4"	14,5	60,0	50,0	5	30	0,118	TTKE02025X
25	1/2"	16,0	60,0	51,0	10	80	0,088	TTKE02520X
25	3/4"	16,0	65,0	52,5	5	25	0,122	TTKE02525X
32	3/4"	18,0	71,0	58,3	5	20	0,146	TTKE03225E
32	1"	18,0	80,0	60,0	5	20	0,208	TTKE03232E

ALL PLASTIC WELD IN SADDLE

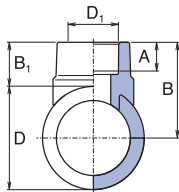

D mm	D ₁ mm	A mm	B ₁ mm	B mm	⊞ I.	⊞ II.	⚖ kg/pc	KODE
63	32	18,0	27,0	58,5	10	50	0,034	TNS06332RCT
75	32	18,0	27,0	64,5	10	50	0,032	TNS07532RCT
90	32	18,0	27,0	72,0	10	50	0,034	TNS09032RCT
110	32	18,0	25,7	80,7	5	40	0,044	TNS11032RCT
110	40	21,0	25,7	80,7	5	40	0,048	TNS11040RCT
125	32	18,0	22,0	84,5	5	40	0,033	TNS12532RCT
125	40	21,0	28,0	90,5	5	40	0,037	TNS12540RCT
125	50	23,5	29,5	92,0	1	5	0,042	TNS12550RCT
125	63	27,5	37,0	99,5	1	5	0,047	TNS12563RCT

Weld in Saddle with Metal Female Thread

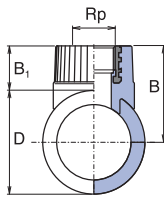

D mm	Rp	B ₁ mm	B mm	⊞ I.	⚖ kg/pc	KODE
63	3/4"	27,0	58,5	10	0,084	TNSI06325X
75	3/4"	27,0	64,5	10	0,084	TNSI07525X
90	3/4"	27,0	72,0	10	0,084	TNSI09025X

Weld in Saddle with Metal Male Thread

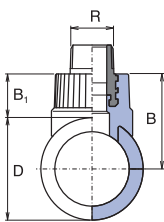

D mm	Rp	B ₁ mm	B mm	⊞ I.	⚖ kg/pc	KODE
63	3/4"	44,8	76,3	10	0,112	TNSE06325X
75	3/4"	44,8	82,3	10	0,110	TNSE07525X
90	3/4"	44,8	89,8	10	0,110	TNSE09025X

Filter

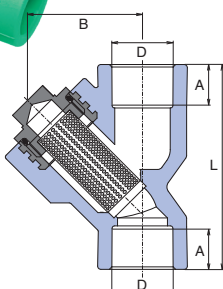
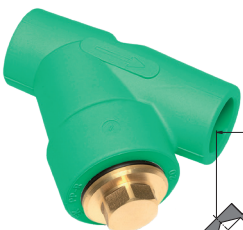

D mm	B mm	L mm	A mm	⊞ I.	⊞ II.	⚖ kg/pc	KODE
20	45,0	76,0	14,5	5	40	0,116	TFI020XXXX
25	45,0	82,0	16,0	5	40	0,134	TFI025XXXX
32	55,0	95,0	18,0	5	40	0,234	TFI032XXXX

Standar untuk Air Minum (dingin) dan Air Panas serta Pemanas (I.)

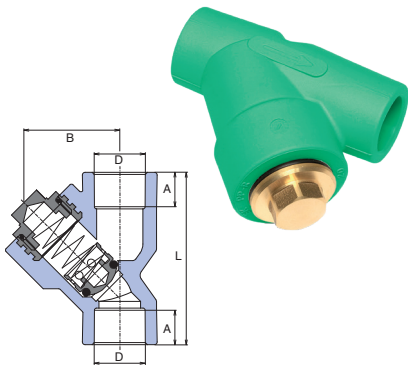

Back Flow Valve

D mm	B mm	L mm	A mm	⊠ I.	⊠ II.	⚖️ kg/pc	KODE
20	45,0	76,0	14,5	5	40	0,136	TZKL020XXX
25	45,0	82,0	16,0	5	40	0,154	TZKL025XXX
32	55,0	95,0	18,0	5	40	0,266	TZKL032XXX

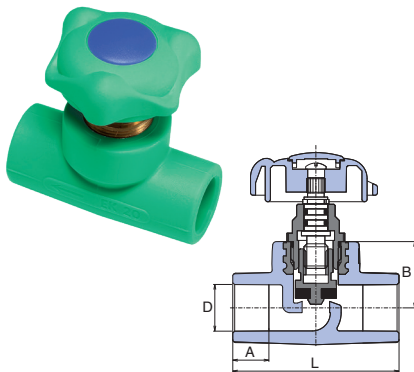

Straight – Way Valve

D mm	A mm	B mm	L mm	⊠ I.	⊠ II.	⚖️ kg/pc	KODE
20	14,5	27,5	69,0	10	50	0,140	TVE020XXXX
25	16,0	30,0	80,0	10	30	0,192	TVE025XXXX
32	18,0	39,0	89,0	5	15	0,380	TVE032XXXX
40	20,5	41,0	112,0	5	5	0,542	TVE040XXXX
50	23,5	48,0	136,0	1	1	0,732	TVE050XXXX
63	27,5	60,0	162,0	1	1	1,330	TVE063XXXX

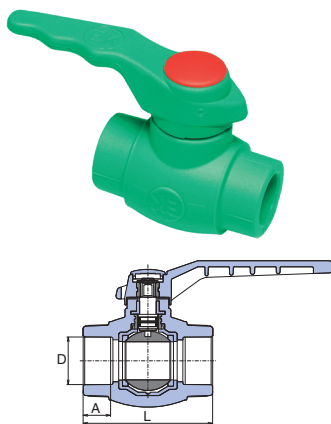

Ball Tap Plastic

D mm	A mm	L mm	⊠ I.	⊠ II.	⚖️ kg/pc	KODE
16	13,0	59,5	10	50	0,092	TVEK016XXX
20	14,5	65,0	10	50	0,116	TVEK020XXX
25	16,0	71,0	10	40	0,168	TVEK025XXX
32	18,0	85,0	10	20	0,294	TVEK032XXX
40	20,5	100,0	5	10	0,544	TVEK040XXX
50	23,5	115,0	1	5	0,874	TVEK050XXX
63	27,5	134,0	1	5	1,278	TVEK063XXX

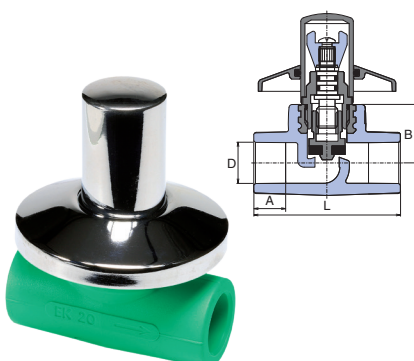

Shut off Valve Straight with Chrome Cover

D mm	A mm	B mm	L mm	⊠ I.	⊠ II.	⚖️ kg/pc	KODE
20	14,5	27,5	69,0	5	20	0,208	TVEKPLK020
25	16,0	30,0	80,0	5	20	0,270	TVEKPLK025E

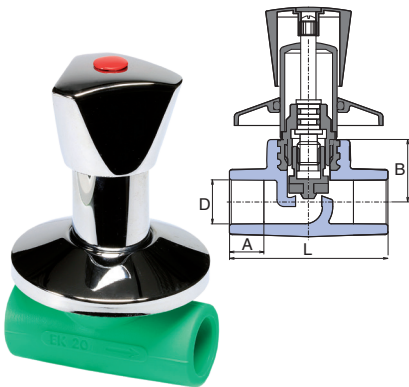

Shut off Valve Deluxe Straight with Chrome Handle

D mm	A mm	B mm	L mm	☒ I.	☒ II.	⚖️ kg/pc	KODE
20	14,5	27,5	69,0	5	20	0,338	TVEPLR020X
25	16,0	30,0	80,0	5	20	0,392	TVEPLR025X

Valve Extension D 20, 25 mm

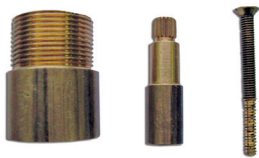

☒ I.	⚖️ kg/pc	KODE
1	0,071	VEPL020XXX

extension for shut off valves straight Ø 20 a 25 mm

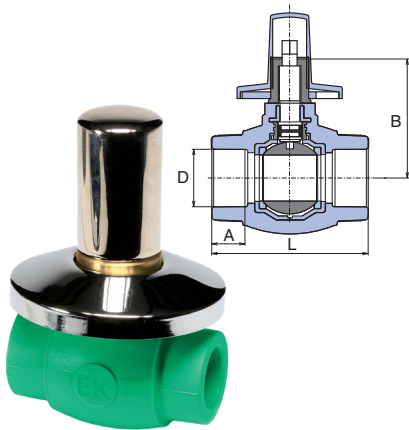

Shut off Ball Tap with Chrome Cover

D mm	A mm	B mm	L mm	☒ I.	☒ II.	⚖️ kg/pc	KODE
20	14,5	67,0	65,0	5	20	0,254	TVEKPLK020
25	16,0	65,0	71,0	5	20	0,334	TVEKPLK025

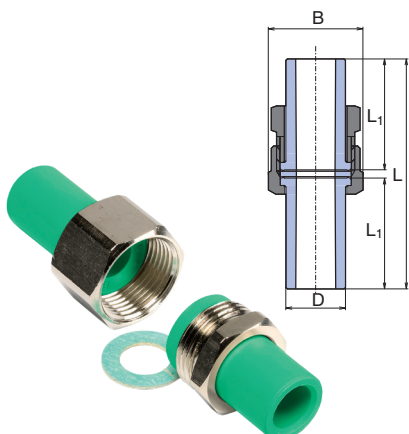

Coupling with Nut

D mm	B mm	L mm	L ₁ mm	☒ I.	☒ II.	⚖️ kg/pc	KODE
20	30,0	82,0	40,0	20	100	0,088	TRS020XXXX
25	38,0	82,0	40,0	20	100	0,142	TRS025XXXX
32	46,0	92,0	45,0	10	50	0,212	TRS032XXXX
40	58,0	112,0	55,0	5	5	0,288	TRS040XXXX

Standar untuk Air Minum (dingin) dan Air Panas serta Pemanas (I.)

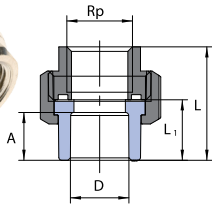

Screw Union with Socket - Female

D mm	Rp	L mm	L ₁ mm	☒ I.	☒ II.	⚖ kg/pc	KODE
20	1/2"	37,5	19,5	10	100	0,122	TSHI02020X
25	3/4"	46,5	23,0	10	70	0,213	TSHI02525X

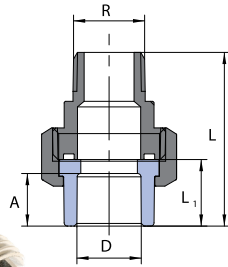
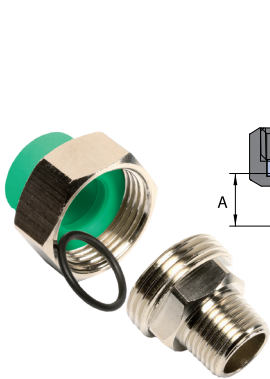

Screw Union with Socket - Male

D mm	Rp	L mm	L ₁ mm	☒ I.	☒ II.	⚖ kg/pc	KODE
20	1/2"	52,5	19,5	10	100	0,142	TSHE02020X
25	3/4"	59,0	23,0	10	50	0,223	TSHE02525X

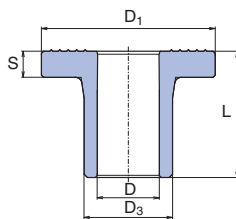

Flange Adaptor

D ₃ mm	L mm	D ₁ mm	S mm	D mm	☒ I.	☒ II.	⚖ kg/pc	KODE
40	58,0	80,0	12,0	30,0	2	70	0,040	TLN040RCTX
50	60,0	90,0	12,0	37,2	2	60	0,065	TLN050RCTX
63	63,0	105,0	14,0	47,0	1	40	0,127	TLN063RCTX
75	73,0	123,0	14,7	56,0	1	25	0,205	TLN075RCTX
90	92,0	140,0	17,0	67,0	1	15	0,320	TLN090RCTX
110	103,0	160,0	19,0	81,0	1	10	0,593	TLN110RCTX

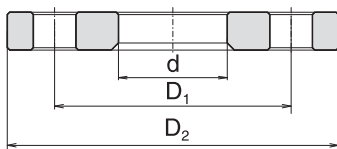

Flange

	D ₁ mm	D ₂ mm	d mm	Y	☒	⚖ kg/pc	KODE
40 / DN32	100,0	140,0	46,0	4	1	1,660	PRI040NXXX
50 / DN40	110,0	150,0	54,0	4	1	1,802	PRI050NXXX
63 / DN50	125,0	165,0	66,0	4	1	2,414	PRI063NXXX
75 / DN65	145,0	185,0	83,0	8	1	2,978	PRI075NXXX
90 / DN80	160,0	200,0	94,0	8	1	3,490	PRI090NXXX
110 / DN100	180,0	220,0	114,0	8	1	4,098	PRI110NXXX
125 / DN150	210,0	250,0	166,0	8	1	4,450	PRI125NXXX

☉ Y – number of bore holes

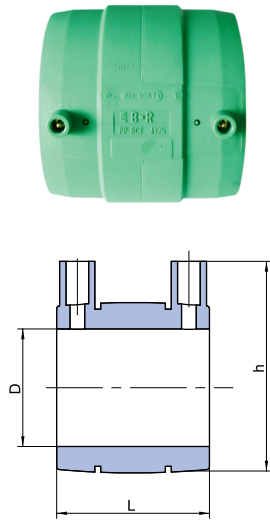

Electro – Fusion Socket

D mm	L mm	h mm	☒ I.	☒ II.	⚖ kg/pc	KODE
20	70	52	1	100	0,040	ENA020PPRCT
25	70	57	1	80	0,050	ENA025PPRCT
32	80	65	1	60	0,070	ENA032PPRCT
40	90	74	1	50	0,100	ENA040PPRCT
50	100	85	1	30	0,160	ENA050PPRCT
63	110	97	1	20	0,260	ENA063PPRCT
75	120	114	1	25	0,410	ENA075PPRCT
90	130	130	1	18	0,510	ENA090PPRCT
110	140	152	1	8	0,800	ENA110PPRCT
125	151	168	1	6	0,950	ENA125PPRCT

job-order manufacture, delivery date 30 days

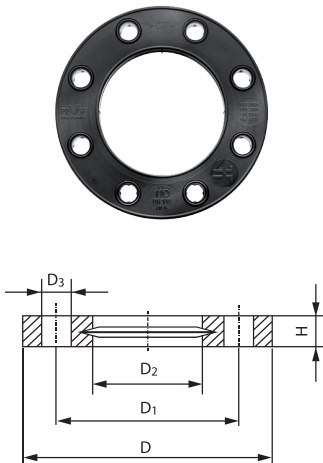

Flange PP – Fiberglass PN 16

d mm	DN mm	D mm	D ₁ mm	D ₂ mm	D ₃ mm	H mm	Y	☒	⚖ kg/pc	KODE
40	32	140	100	51	18	20	4	1	0,244	FF700409W
50	40	150	110	62	18	22	4	1	0,297	FF700410W
63	50	165	125	78	18	24	4	1	0,362	FF700411W
75	65	185	145	92	18	26	4	1	0,487	FF700412W
90	80	200	160	108	18	27	8	1	0,544	FF700513W
110	100	220	180	128	18	28	8	1	0,643	FF700514W
140	125	250	210	158	18	30	8	1	0,842	FF700516W

Y – number of bore holes



Flange PP – Steel PN 16

d mm	DN mm	D mm	D ₁ mm	D ₂ mm	D ₃ mm	H mm	Y	☒	⚖ kg/pc	KODE
40	32	140	100	51	18	16	4	1	0,621	FF700209W
50	40	150	110	62	18	20	4	1	0,722	FF700210W
63	50	165	125	78	18	20	4	1	1,084	FF700211W
75	65	185	145	92	18	20	4	1	1,349	FF700212W
90	80	200	160	108	18	20	8	1	1,390	FF700513W
110	100	220	180	128	18	20	8	1	1,407	FF700514W
140	125	250	210	158	18	26	8	1	2,318	FF700216W

Y – number of bore holes

Sambungan Lengkap untuk Pemasangan pada Dinding Gypsum (I.)

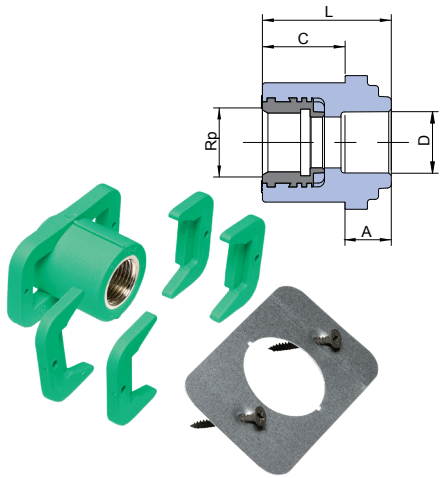

Reducing Sleeve for Gypsum Wall Mounting

D mm	Rp	A mm	C mm	L mm	I. I.	II. II.	kg/pc	KODE
20	1/2"	14,5	26,0	40,5	1	10	0,102	TZS02020X

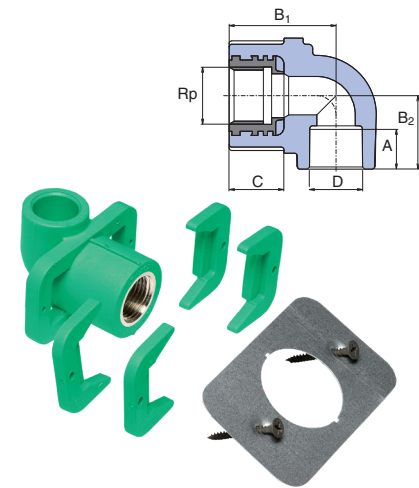

Elbow for Gypsum Wall Mounting

B mm	Rp	A mm	B ₁ mm	B ₂ mm	C mm	I. I.	II. II.	kg/pc	KODE
20	1/2"	15	44,0	27,0	26,0	1	10	0,114	TNKS020SX

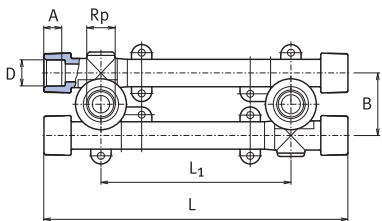

Wall Mounting Group with Tap Connectors for Gypsum Wall

D mm	Rp	A mm	B mm	L ₁ mm	C mm	L mm	I. I.	II. II.	kg/pc	KODE
20	1/2"	14,5	49,0	100/135/150	26,0	234,0	1	10	0,320	TNKK020SXX

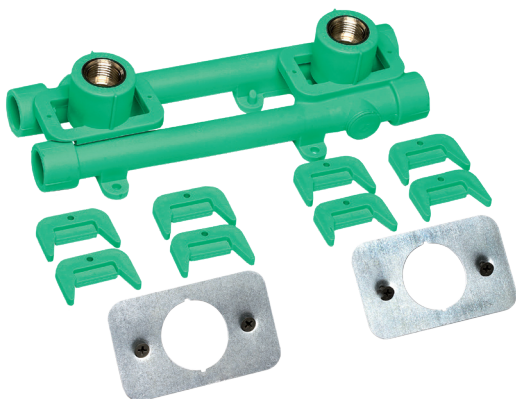

Produk Standar Khusus untuk Air Minum (Dingin) (II.)

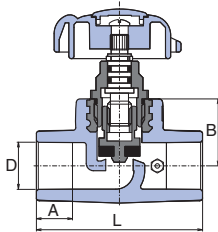

Straight – Way Valve with Drain Valve

	D mm	A mm	B mm	L mm	☒	⚖ kg/pc	KODE
right	40	20,5	41,0	112,0	1	0,578	TVEV040PXX
right	50	23,5	48,0	136,0	1	0,788	TVEV050PXX
right	63	27,5	60,0	162,0	1	1,388	TVEV063PXX
left	40	20,5	41,0	112,0	1	0,572	TVEV040LXX
left	50	23,5	48,0	136,0	1	0,754	TVEV050LXX
left	63	27,5	60,0	162,0	1	1,416	TVEV063LXX

job-order manufacture, delivery date 30 days

Produk untuk Pemakaian Sementara (III.)

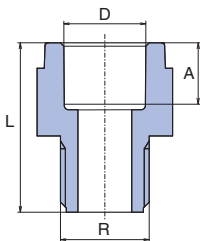

All-Plastic Reducer Male Thread

D mm	R	A mm	L mm	☒ I.	☒ II.	⚖ kg/pc	KODE
20	1/2"	14,5	40,0	50	200	0,014	SDG02020XX
20	3/4"	14,5	38,0	50	500	0,012	SDG02025XX
25	3/4"	16,0	42,0	50	300	0,020	SDG02525XX
32	1"	18,0	54,0	25	150	0,038	SDG03232XX
40	5/4"	20,5	62,0	10	100	0,074	SDG04040XX
50	6/4"	23,5	63,0	10	50	0,094	SDG05050XX
63	2"	27,5	81,9	5	35	0,194	SDG06363XX

delivered in grey colour

Aksesoris (IV.)

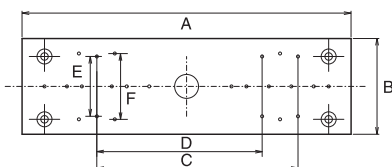
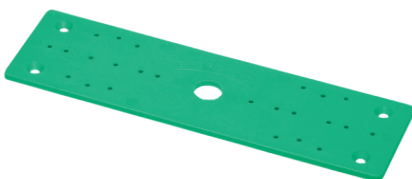

Assembly Plate for Elbow 90 ° for Wall Mounting

A mm	B mm	C mm	D mm	E mm	F mm	☒ I.	☒ II.	⚖ kg/pc	KODE
220,0	64,0	135,0	110,0	45,0	40,0	10	50	0,058	DNPXXXXXXX

Aksesoris (IV.)



Metal Sleeve (with Wood Screw)

D mm	I.	II.	kg/pc	KODE
20-25	25	100	0,056	PRK02025XX
32-40	25	100	0,074	PRK03240XX
50-63	5	50	0,124	PRK06350XX



Metal Sleeve (Screw / Nut)

D mm	NUT mm	SCREW mm	I.	II.	kg/pc	KODE
48-53	M8/10		5	50	0,078	PRKB04853X
72-78	M8/10		5	10	0,146	PRKB07278X
87-92	M8/10		5	10	0,180	PRKB08792X
102-116	M8/10		5	10	0,238	PRKB102116
		M8/100	10	10	0,023	VRUTM8100X



Plastic Clip

D mm	I.	II.	kg/pc	KODE
16	50	300	0,004	PRE016TXXX
20	50	500	0,004	PRE020TXXX
25	50	500	0,006	PRE025TXXX
32	50	300	0,008	PRE032TXXX
⊙ 40	1	50	0,016	PRP040TXXX
⊙ 50	1	25	0,034	PRP050TXXX
⊙ 63	1	25	0,046	PRP063TXXX
⊙ 75	1	1	0,084	PRP075TXXX
⊙ 90	1	1	0,114	PRP090TXXX
⊙ 110	1	1	0,136	PRP110TXXX

⊙ with tape

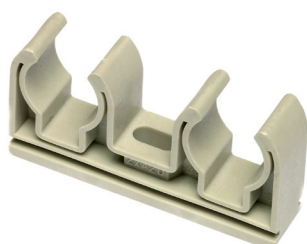



Plastic Double Clip

D mm	I.	kg/pc	KODE
2×20	1	0,016	PRDV0202XX
2×25	1	0,022	PRDV0252XX

delivered in grey colour

Welding Machine Electronic R63 (for Paired Adapter)



	W		 kg/pc	KODE
R63	800	1	1,820	SVA063XXXX

job-order manufacture, delivery date 30 days

Repairing Set





		 kg/pc	KODE
komplet	1	0,186	OSAXXXXXXX

Repairing set includes 5 pcs of repairing stakes \varnothing 12 mm and non-paired adapter \varnothing 12 mm



Repairing Stakes



\varnothing MM	 I.	 kg/pc	KODE
12	1(5)	0,029	OTXXXXXXXX

Electrofusion Welding Machine - Elektra Light



	W		 kg/pc	KODE
20 - 125/160 MM	2000	1	8,000	SVAELEKTRAL

job-order manufacture, delivery date 30 days

Aksesoris (IV.)

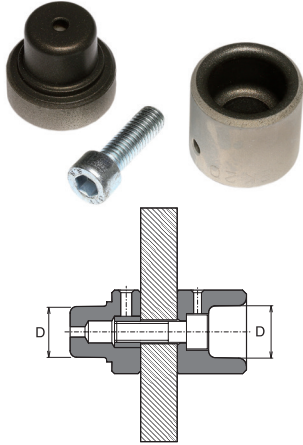

Adapter Paired

D mm	📦	⚖️ kg/pc	KODE
16	1	0,074	NAP016XXXX
20	1	0,078	NAP020XXXX
25	1	0,138	NAP025XXXX
32	1	0,164	NAP032XXXX
40	1	0,308	NAP040XXXX
50	1	0,333	NAP050XXXX
63	1	0,493	NAP063XXXX
75	1	0,653	NAP075XXXX
90	1	1,089	NAP090XXXX
110	1	1,681	NAP110XXXX
125	1	1,996	NAP125XXXX

Adapter Non-Paired

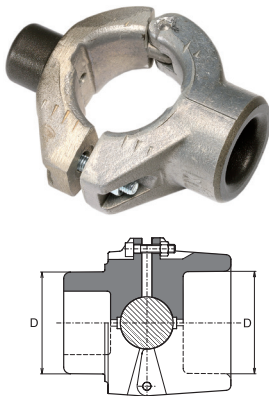

D mm	📦	⚖️ kg/pc	KODE
16	1	0,130	NA016CXXXX
20	1	0,133	NA020CXXXX
25	1	0,178	NA025CXXXX
32	1	0,215	NA032CXXXX
40	1	0,379	NA040CXXXX
50	1	0,517	NA050CXXXX
63	1	0,822	NA063CXXXX

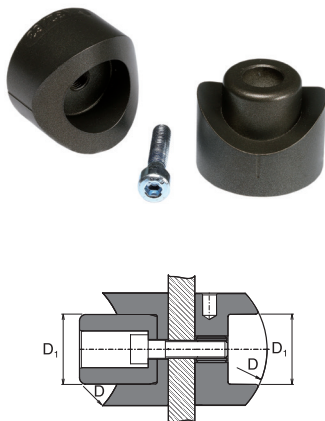



Adapter for Weld in Saddle / Paired

D mm	D ₁ mm	📦	⚖️ kg/pc	KODE
63	32	1	0,298	SNNS06332X
75	32	1	0,296	SNNS07532X
90	32	1	0,296	SNNS09032X
⊕ 110	40	1	0,432	SNNS11040X
125	40	1	0,519	SNNS12540X
125	63	1	1,148	SNNS12563X

⊕ for weld in saddle with diameter 110/32 and 110/40

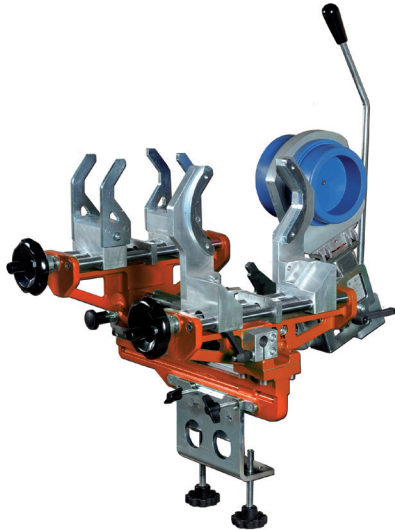
Welding Jig MP-125





	D mm		 kg/pc	KODE
MP-125	63-125	1	37,200	SVAMP125XX

MP 125 termasuk rangka, dudukan untuk welding machine dengan pemakaian daya sebesar 1400 W, khusus dengan aksesoris.

job-order manufacture, delivery date 30 days

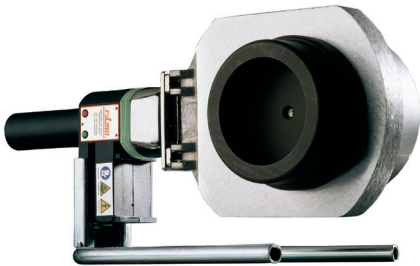
Welding Machine PRISMA 125





W		 kg/pc	KODE
1400	1	2,760	SVA125XXXX

job-order manufacture, delivery date 30 days

Contact Thermometer „DT” Meter





		 kg/pc	KODE
DT-METER	1	0,940	TEPODXXXXX

Aksesoris (IV.)





Tightening Spanner with Band

		 kg/pc	KODE
	1	0,297	UKXXXXXXXXX





Pipe Cutter – Shear (PROFI)

D mm		 kg/pc	KODE
16-40	1	0,383	NU042PXXXX





Pipe Cutter – Shear (PROFI M2)

D mm		 kg/pc	KODE
16-63	1	1,241	NU063XXXXX



Pipe Cutter

D mm		 kg/pc	KODE
50-140	1	1,400	REZ050125X

Stabi Pipe Shaver



D mm	⊞	⚖ kg/pc	KODE
16-20	1	0,134	REZS01620X
20-25	1	0,156	REZS02025X
25-32	1	0,206	REZS02532X
32-40	1	0,266	REZS03240X
50	1	0,302	REZS050XXX
63	1	0,352	REZS063XXX
75	1	0,386	REZS075XXX
90	1	0,634	REZS090XXX
110	1	0,870	REZS110XXX



Shavers to Drill Machine for Stabi Pipes

D mm	⊞	⚖ kg/pc	KODE
40	1	0,290	REZS040VXX
50	1	0,882	REZS050VXX
63	1	0,406	REZS063VXX
pintle	1	0,020	CEPXXXXXXXX

Drill for Weld in Saddle

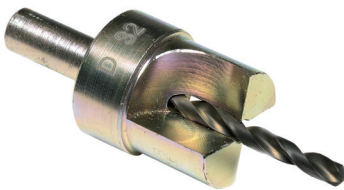

D mm	⊞	⚖ kg/pc	KODE
32	1	0,200	VNS032XXXX
40	1	0,300	VNS040XXXX
63	1	0,347	VNS063XXXX

Galvanized Trough

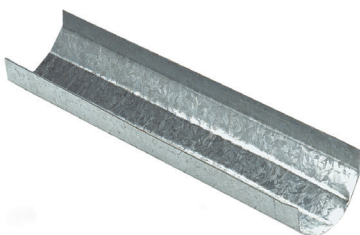

D mm	I mm	⊞ I.	⊞ II.	⚖ kg/pc	KODE
20	2000	1	25	0,331	ZLSP20XXXX
25	2000	1	25	0,428	ZLSP25XXXX
32	2000	1	25	0,516	ZLSP32XXXX
40	2000	1	25	0,607	ZLSP40XXXX
50	2000	1	25	0,732	ZLSP50XXXX
63	2000	1	25	0,879	ZLSP63XXXX

Aksesoris (IV.)



Plug – Short

G	I.	II.	kg/pc	KODE
1/2"	50	250	0,008	ZAGXXXXXX

including rubber sea



Plug – Long

G	I.	II.	kg/pc	KODE
1/2"	50	250	0,022	ZAGDXXXXXX

including rubber sea



Mastic Sealant – Siseal

gr	I.	kg/pc	KODE
10	1	0,018	TMSIS10XXX
100	1	0,124	TMSIS100XX



Sealing Teflon Fibre

m	kg/pc	KODE
50	0,053	TTN50XXXXX
150	0,126	TTN150XXXX



- ⦿ Produksi dan pengetesan memakai standar EN ISO 15874. Persyaratan atas standar ini tertuang dalam PN 01 (Internal Company Standard / Standar Internal Perusahaan).
- ⦿ Aplikasi dan pemasangan produk harus sesuai dengan regulasi pemasangan dari ekoplastik system.
- ⦿ Kualitas sistem bersertifikat sesuai dengan ISO 9001-2000
- ⦿ Garansi produk hingga 10 tahun untuk produk-produk standar (I.,II.)
- ⦿ Garansi umum 2 tahun untuk produk lainnya (III.,IV.)

PENGUNAAN SHORTCUTS

KODE – kode pemesanan S/

PN – seri / pressure line

I. 📦 – packing kecil

II. 📦 – packing besar

G – female cylindrical thread no sealing on threads

Rp – female cylindrical thread sealing on threads

R – male conical thread sealing on threads

Produk lebih lengkap dapat dilihat pada www.wavin.com/en-id

Hot & Cold Water

Indoor Climate

Soil & Waste

Foul Water

Storm Water

Gas & Water Mains

Geotextiles

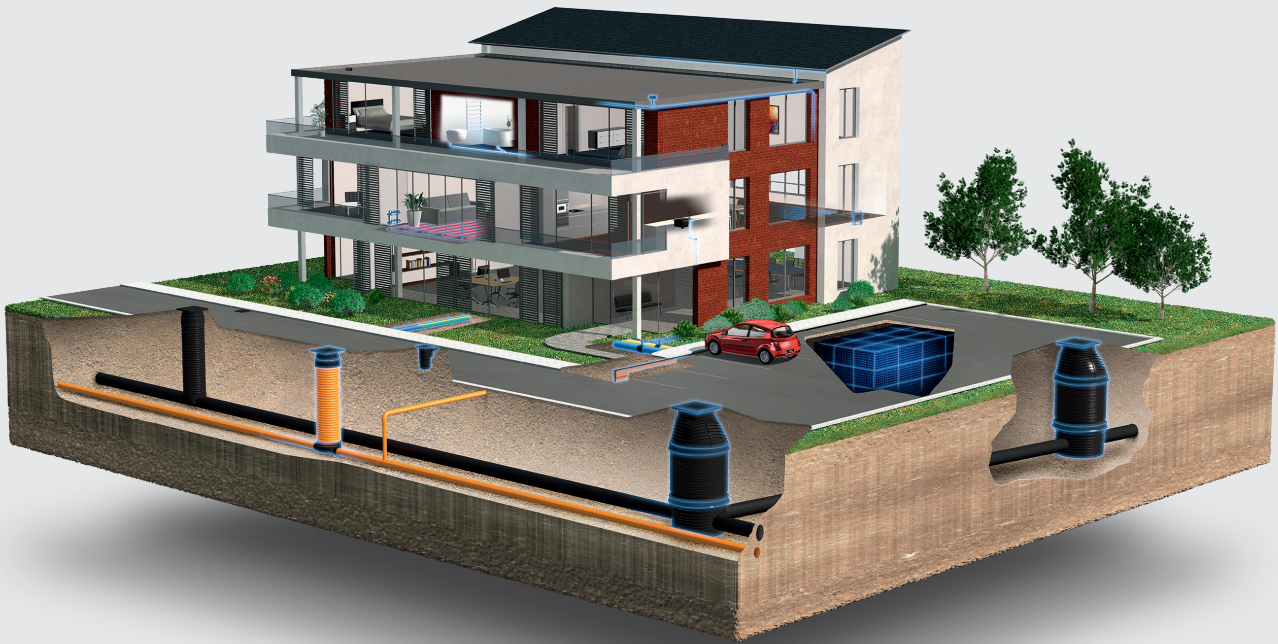

Wavin merupakan bagian dari Orbia, sebuah komunitas perusahaan yang secara bersama-sama berperan mengatasi permasalahan dunia yang kompleks. Kami terikat dengan kesamaan tujuan: memajukan kehidupan di seluruh dunia.



PT Wavin Indonesia

Talavera Office Suite - Marquee, 18th Floor - Suite 407 Jl. TB Simatupang, Kav 22-2612430 Jakarta, Indonesia
Phone: 021 2971 5887 | E-mail: Indonesia@wavin.com | www.wavin.com/en-id



Wavin senantiasa melakukan pengembangan dan perbaikan produk secara terus-menerus, karena itu berhak melakukan modifikasi dan penyesuaian spesifikasi produk tanpa pemberitahuan. Semua informasi dalam publikasi ini diberikan dengan itikad baik, dan diyakini benar pada saat dipublikasikan. Akan tetapi, tidak mengharuskan pertanggung jawaban untuk setiap kesalahan, kelalaian atau asumsi yang salah.

© 2020 Wavin berhak melakukan perubahan tanpa pemberitahuan terlebih dahulu. Untuk pengembangan produk secara terus menerus, pembaharuan spesifikasi teknis dapat dilakukan. Instalasi harus sesuai dengan instruksi pemasangan.